

## ON THE CLASSIFICATION OF TIGHT CONTACT STRUCTURES II

KO HONDA

### Abstract

We present complete classification results for tight contact structures on two classes of 3-manifolds: (i) torus bundles which fiber over the circle and (ii) circle bundles which fiber over closed surfaces.

### Introduction

Contact structures in dimension three come in two flavors: tight or overtwisted. Overtwisted contact structures on closed 3-manifolds have been classified for about a decade (due to Eliashberg [3]), having been shown to reflect only homotopy-theoretic information of 2-plane fields on the ambient manifold. Tight contact structures, on the other hand, seem to reflect the underlying topology of the 3-manifold. However, until recently, a complete classification of tight contact structures was known only for a handful of 3-manifolds. The list more or less consisted of  $S^3$ ,  $\mathbb{R}^3$ ,  $S^1 \times S^2$  (due to Eliashberg [4]), the 3-torus  $T^3$  (proved independently by Giroux and Kanda [14]), and a few lens spaces (due to Etnyre [6]).

Very recently the author [13] and Giroux [10] independently succeeded in completely classifying tight contact structures on solid tori  $S^1 \times D^2$ ,  $T^2 \times [0, 1]$ , and lens spaces  $L(p, q)$ ,  $p > q > 0$ . The goal of this paper is to apply the techniques developed in [13] to give *complete* classification results for two basic classes of 3-manifolds:  $T^2$ -bundles

---

Received October 19, 1999. The author was supported in part by NSF grant DMS-0072853 and the American Institute of Mathematics.

*Key words and phrases.* tight, contact structure

1991 *Mathematics Subject Classification.* Primary 57M50; Secondary 53C15.

which fiber over  $S^1$  and circle bundles which fiber over closed oriented surfaces. Our classification of tight contact structures on  $T^2$ -bundles over  $S^1$  completes the study initiated by Giroux in [9]. It should also be noted that Giroux has also independently obtained similar results — see [10] and [11]. However, although Giroux completely classifies tight contact structures on *almost all* 3-manifolds of the type considered here, there are a few tricky cases where he only gives an upper bound. In this paper we devote considerable space to treat these tricky cases.

An important distinction in contact topology is the distinction between *universally tight* contact structures and *virtually overtwisted* contact structures.  $(M, \xi)$  is *universally tight* if  $(\tilde{M}, \tilde{\xi})$  is tight, where  $\tilde{M} \rightarrow M$  is the universal cover and  $\tilde{\xi}$  is the lift of  $\xi$  to  $\tilde{M}$ . On the other hand,  $(M, \xi)$  is *virtually overtwisted* if  $\xi$  is tight on  $M$  but becomes overtwisted when pulled back to some finite cover of  $M$ . It is currently not known whether every tight contact structure falls into one of the two categories (in other words, whether a tight contact structure which becomes overtwisted when lifted to  $\tilde{M}$  is overtwisted in a finite cover) — however all known examples fall into one of the two categories, and the dichotomy holds when  $\pi_1(M)$  is residually finite (which is the case, for example, when  $M$  is Haken or hyperbolic). Universally tight contact structures with universal cover  $\mathbb{R}^3$  are rather close in spirit to taut foliations. In fact, a small perturbation of a taut foliation into a contact structure is universally tight, due to the work of Eliashberg and Thurston [5]. Moreover, it is possible to glue together universally tight contact structures with universal cover  $\mathbb{R}^3$  along incompressible tori which are linearly foliated (this is due to Colin [1]). Largely due to these two developments, understanding universally tight structures with universal cover  $\mathbb{R}^3$ , in general, is a much more straightforward task than understanding virtually overtwisted contact structures.

Another twist to understanding universally tight structures is the realization that, in all known examples, the existence of an incompressible torus implies the existence of a countable infinity of universally tight structures, distinguished by the amount of ‘twisting’ that happens transverse to the incompressible torus (the notion of ‘twisting’ will be made precise below). The first examples are due to Giroux [7] and Kanda [14] on the 3-torus, which were extended to all torus bundles over  $S^1$  by Giroux [9], and subsequently to any 3-manifold which has an incompressible torus which ‘persistently’ intersects another torus by Colin [2].

Throughout this paper, we assume all the 3-manifolds are oriented and all the contact structures are *oriented* and *positive*, i.e., given by a global 1-form  $\alpha$  satisfying  $\alpha \wedge d\alpha > 0$ . We will assume the reader has already read [13] and is familiar with convex surface theory, bypasses, and the classification of tight contact structures on solid tori and  $T^2 \times I$ . We will freely use terminology which is defined there. Also, when we refer to an ‘isotopy’, we mean an isotopy in the  $C^\infty$ -category, as opposed to a ‘contact isotopy’, which is an isotopy preserving the contact structure.

### Part 1. Tight contact structures on torus bundles which fiber over the circle

The first part of this paper is devoted to classifying tight contact structures on torus bundles over the circle. Giroux, in [9], showed that there exist  $\mathbb{Z}^+$ -many tight structures on all  $T^2$ -bundles over  $S^1$ , all universally tight. The goal of this paper is to complement his study of the universally tight contact structures by a careful analysis of those that are not necessarily universally tight — this is done as an application of the classification of tight structures on  $T^2 \times I$  in [13].

A  $T^2$ -bundle  $M$  over  $S^1$  can be viewed as  $T^2 \times I = \mathbb{R}^2/\mathbb{Z}^2 \times [0, 1]$  with coordinates  $(\mathbf{x}, t) = (x, y, t)$ , together with the *monodromy map*  $A : T^2 \times \{1\} \rightarrow T^2 \times \{0\}$ , where  $(\mathbf{x}, 1) \mapsto (A\mathbf{x}, 0)$ . The  $T^2$ -bundle only depends on the conjugacy class  $[A]$  in  $SL(2, \mathbb{Z})$ . We will choose convenient representatives in Lemma 2.1, which greatly facilitates our classification.

**0.0.1. Definition of twisting.** In order to explain our classification result, we first need to give some definitions and make the notion of ‘twisting’ precise. Given a convex torus  $\Sigma = \mathbb{R}^2/\mathbb{Z}^2$  in a tight contact manifold, its *slope* is the slope of a closed linear curve on  $\Sigma$  which is isotopic to a dividing curve. Observe that the slope is well-defined because the dividing curves are parallel and homotopically essential, if  $\Sigma$  is inside a tight manifold. Given a slope  $s$  of a line in  $\mathbb{R}^2$  (or  $\mathbb{R}^2/\mathbb{Z}^2$ ), associate to it its standard angle  $\bar{\alpha}(s) \in \mathbb{RP}^1 = \mathbb{R}/\pi\mathbb{Z}$ . For  $\bar{\alpha}_1, \bar{\alpha}_2 \in \mathbb{RP}^1$ , let  $[\bar{\alpha}_1, \bar{\alpha}_2]$  be the image of the interval  $[\alpha_1, \alpha_2] \subset \mathbb{R}$ , where  $\alpha_i \in \mathbb{R}$  are representatives of  $\bar{\alpha}_i$  and  $\alpha_1 \leq \alpha_2 < \alpha_1 + \pi$ . A slope  $s$  is said to be *between*  $s_1$  and  $s_0$  if  $\bar{\alpha}(s) \in [\bar{\alpha}(s_1), \bar{\alpha}(s_0)]$ .

Consider a tight contact structure  $\xi$  on  $T^2 \times I$  with boundary slopes  $s_i$  for  $T^2 \times \{i\}$ ,  $i = 0, 1$ .  $\xi$  is *minimally twisting* if every convex torus

parallel to the boundary has slope  $s$  between  $s_1$  and  $s_0$ . Define the  $I$ -twisting of a tight  $\xi$  to be  $\beta_I = \alpha(s_0) - \alpha(s_1) = \sum_{k=1}^l (\alpha(s_{\frac{k-1}{l}}) - \alpha(s_{\frac{k}{l}}))$ , where (i)  $s_{\frac{k}{l}}$  are slopes of  $T_{\frac{k}{l}}$ ,  $k = 0, \dots, l$ , (ii)  $T_0 = T^2 \times \{0\}$ ,  $T_1 = T^2 \times \{1\}$ , and  $T_{\frac{k}{l}}$ ,  $k = 1, \dots, l-1$  are mutually disjoint convex tori parallel to the boundary, arranged in order from closest to  $T_0$  to farthest from  $T_0$ , (iii)  $\xi$  is minimally twisting between  $T_{\frac{k-1}{l}}$  and  $T_{\frac{k}{l}}$ , and (iv)  $\alpha(s_{\frac{k}{l}}) \leq \alpha(s_{\frac{k-1}{l}}) < \alpha(s_{\frac{k}{l}}) + \pi$ . The  $I$ -twisting of  $\xi$  is well-defined and independent of the choices of  $l$  and the  $T_{\frac{k}{l}}$ . For a proof of this fact see Section 5.2 of [13]. Note that the  $I$ -twisting  $\beta_I$  is dependent on the particular identification of  $T^2$  with  $\mathbb{R}^2/\mathbb{Z}^2$ . If we want to extract an invariant which is independent of the identification, we take  $\phi_I(\xi) = \pi \lfloor \frac{\beta_I}{\pi} \rfloor$ , where  $\lfloor \cdot \rfloor$  is the greatest integer function.

Let  $\xi$  be tight on  $M$ . Then  $\xi$  is said to be *minimally twisting in the  $S^1$ -direction*, if every splitting of  $M$  along a convex torus  $\Sigma$  isotopic to a fiber  $T^2$  gives a minimally twisting  $(T^2 \times I, \xi)$ . The  $S^1$ -twisting  $\beta_{S^1}$  of  $\xi$  on  $M$  is the supremum, over all convex tori  $\Sigma$  isotopic to a fiber  $T^2$ , of  $n\pi$ , where  $n \in \mathbb{Z}^{\geq 0}$ , and  $n\pi \leq \beta_I < (n+1)\pi$  on the  $T^2 \times I$  obtained by cutting  $M$  along  $\Sigma$ .

Let us briefly mention the relationship to Giroux's *torsion* invariant [9]. On  $T^2 \times [0, 1] \simeq \mathbb{R}^2/\mathbb{Z}^2 \times [0, 1]$  with coordinates  $((x, y), z)$ , consider  $\xi_n = \ker \alpha_n$ ,  $n \in \mathbb{Z}^+$ , where  $\alpha_n = \sin(\pi n z) dx + \cos(\pi n z) dy$ . Given a contact 3-manifold  $(X, \xi)$ , together with an isotopy class  $[C]$  of tori in  $X$ , we define the *torsion*  $\text{tor}(X, \xi, [C])$  to be the supremum, over  $n \in \mathbb{Z}^+$ , for which there exists a contact embedding  $\phi : (T^2 \times [0, 1], \xi_n) \hookrightarrow (X, \xi)$ , where  $\phi(T^2 \times \{pt\}) \in [C]$ . (We set the torsion to be zero if there is no such embedding.) It follows from the classification of universally tight contact structures on  $T^2 \times I$  (see [13]) that

$$\text{tor}(T^2 \times I, \xi, [T^2 \times \{pt\}]) = \phi_I(\xi),$$

provided the torsion is computed for a pre-Lagrangian boundary, and  $\phi_I$  is computed for a convex boundary with the same slope (a slight perturbation of the pre-Lagrangian boundary).

**0.0.2. Statement of theorem.** We now state the classification theorem. Depending on whether  $|\text{tr}(A)| > 2$ ,  $= 2$ , or  $< 2$ , we have the hyperbolic, parabolic, or elliptic classes. Each class has its own flavor. Let  $S = \begin{pmatrix} 0 & 1 \\ -1 & 0 \end{pmatrix}$ , and  $T = \begin{pmatrix} 1 & 1 \\ 0 & 1 \end{pmatrix}$ .

**Theorem 0.1.** *Let  $M$  be a  $T^2$ -bundle over  $S^1$  with monodromy  $A$ .*

Then, up to contact isotopy, the tight contact structures are completely classified as in the table below.

1. (Universally tight contact structures) For each  $A$ , there exist infinitely many universally tight contact structures, all homotopic as plane fields but distinguished by their  $S^1$ -twisting  $\beta_{S^1}$ . Depending on  $A$  the set of possible values for  $\beta_{S^1}$  are  $\{2m\pi | m \in \mathbb{Z}^{\geq 0}\}$ , or  $\{(2m-1)\pi | m \in \mathbb{Z}^+\}$ .
2. (Elliptic case) The torus bundles are all Seifert fibered spaces which fiber over  $S^2$  with 3 multiple fibers. All the tight contact structures are of the type described in (1) and there are no virtually overtwisted contact structures except when  $A = S$  (which has 1) and  $A = (T^{-1}S)^2$  (which has 2).
3. (Parabolic case) There is an abundance of universally tight contact structures which are distinct from the ones generated by twisting in the  $S^1$ -direction — they are obtained by twisting in a direction different from the  $S^1$ -direction of the base. There are invariants  $s \in \mathbb{Q}$  (the slope),  $\mu \in \mathbb{Z}^+$  (the minimal dividing number), and  $l \in \mathbb{Z}$  (the holonomy) which distinguish these universally tight contact structures. (For descriptions of these invariants, refer to Section 2.) Note that not all the invariants are used in each case, and that  $l$  degenerates when  $M$  is a circle bundle over a Klein bottle.
4. (Hyperbolic case) In this generic situation, there is an abundance of virtually overtwisted structures. All the tight contact structures nevertheless survive passage to  $\widetilde{M} = T^2 \times \mathbb{R}$ .
5. Every tight contact structure  $\xi$  on  $M$ , with the exception of one on  $A = S$ , two on  $A = (T^{-1}S)^2$ , one on  $A = T^2$ , and two on  $A = T^n$ ,  $n > 2$ , lifts to a tight structure  $\tilde{\xi}$  on  $\widetilde{M} = T^2 \times \mathbb{R}$ .

We also remark that Giroux proved in [9] that there exist infinitely many universally tight contact structures which are not only non-isotopic but also *non-isomorphic*. Also, the hardest cases are some of the virtually overtwisted contact structures for the elliptic and parabolic cases — Giroux gave only an upper bound in [10]. To prove the tightness of these virtually overtwisted contact structures, we invoke a new gluing technique called *state traversal*. This technique is independent of Legendrian surgery and symplectic filling.

**Comments on the tables below:**

1. In the elliptic cases, the tight contact structures under the ‘Min. Twisting...’ column which are labeled ‘univ. tight’ (footnotes 1, 2, 3) also belong to the family of universally tight contact structures in the column to the left labeled ‘Univ. Tight...’
2. In the hyperbolic cases, for each  $\beta_{S^1} > 0$  there is a unique universally tight contact structure. In the first row of the hyperbolic cases (footnote 4), there are two when  $\beta_{S^1} = 0$  — these are also included in the ‘Min. Twisting...’ column.
3. In the parabolic cases, for each  $\beta_{S^1} > 0$  there is a unique tight contact structure. The universally tight contact structures with zero twisting in the  $S^1$ -direction (footnotes 5, 7, 8) all have  $\beta_{S^1} = 0$  but should be thought of as a different family of universally tight contact structures. The two tight contact structures of footnote 9 also belong to the ‘Univ. Tight...’ column.
4. See footnote 6. These tight contact structures do not belong to either column, but are placed here because of lack of space in the tables.

Type	$A$	Comments	Univ. Tight Structures with Twisting in $S^1$ -direction $\beta_{S^1} =$	Min. Twisting Tight Structures
<b>Elliptic</b> $ \text{tr}(A)  < 2$	$-S = \begin{pmatrix} 0 & -1 \\ 1 & 0 \end{pmatrix}$ rotation $= \frac{\pi}{2}$	Seifert fibered over $S^2$ with invariants $(\frac{1}{2}, -\frac{1}{4}, -\frac{1}{4})$	$2m\pi, m \in \mathbb{Z}^{\geq 0}$	1 (univ. tight) <sup>1</sup>
	$S = \begin{pmatrix} 0 & 1 \\ -1 & 0 \end{pmatrix}$ rotation $= -\frac{\pi}{2}$	Seifert $(-\frac{1}{2}, \frac{1}{4}, \frac{1}{4})$	$(2m-1)\pi, m \in \mathbb{Z}^+$	1 (not univ. tight)
	$-T^{-1}S = \begin{pmatrix} -1 & -1 \\ 1 & 0 \end{pmatrix}$ rotation $= \frac{2\pi}{3}$	Seifert $(\frac{2}{3}, -\frac{1}{3}, -\frac{1}{3})$	$2m\pi, m \in \mathbb{Z}^{\geq 0}$	1 (univ. tight) <sup>2</sup>
	$-(T^{-1}S)^2 = \begin{pmatrix} 0 & -1 \\ 1 & 1 \end{pmatrix}$ rotation $= \frac{\pi}{3}$	Seifert $(\frac{1}{2}, -\frac{1}{3}, -\frac{1}{6})$	$2m\pi, m \in \mathbb{Z}^{\geq 0}$	1 (univ. tight) <sup>3</sup>
	$T^{-1}S = \begin{pmatrix} 1 & 1 \\ -1 & 0 \end{pmatrix}$ rotation $= -\frac{\pi}{3}$	Seifert $(-\frac{1}{2}, \frac{1}{3}, \frac{1}{6})$	$(2m-1)\pi, m \in \mathbb{Z}^+$	0
	$(T^{-1}S)^2 = \begin{pmatrix} 0 & 1 \\ -1 & -1 \end{pmatrix}$ rotation $= -\frac{2\pi}{3}$	Seifert $(-\frac{2}{3}, \frac{1}{3}, \frac{1}{3})$	$(2m-1)\pi, m \in \mathbb{Z}^+$	2 (not univ. tight)

Type	A	Universally Tight Structures with Twisting in $S^1$ -direction $\beta_{S^1} =$	Minimally Twisting Tight Structures
<b>Hyperbolic</b> $ \mathrm{tr}(A)  > 2$	$T^{r_0} S T^{r_1} S \dots T^{r_k} S$ $r_0 < -2$ $r_i \leq 2$	$2m\pi, m \in \mathbb{Z}^{\geq 0}$	$ (r_0 + 1) \dots (r_k + 1) $ tight str., 2 of which are univ. tight <sup>4</sup>
	$-T^{r_0} S T^{r_1} S \dots T^{r_k} S$ $r_0 < -2$ $r_i \leq 2$	$(2m - 1)\pi, m \in \mathbb{Z}^+$	$ (r_0 + 1) \dots (r_k + 1) $ tight str., none of which are univ. tight



Type	$A$	Comments	Universally Tight Structures with Twisting in $S^1$ -direction $\beta_{S^1} =$	Minimally Twisting Tight Structures
<b>Parabolic</b> $ \operatorname{tr}(A)  = 2$	$T^n, n > 0$	Circle bundle over $T^2$ with Euler number $n$	$2m\pi, m \in \mathbb{Z} \geq 0$	Univ. tight given by $(\mu, l)$ ; <sup>5</sup> In addition, <sup>6</sup> for $n \geq 2$ , others which are neither univ. tight nor min. twisting, 1, if $n = 2$ 2, if $n > 2$
	id	3-torus	$2m\pi, m \in \mathbb{Z} \geq 0$	Univ. tight given by $(s, \mu, l)$ <sup>7</sup>
	$T^n, n < 0$	Circle bundle over $T^2$ with Euler number $n$	$2m\pi, m \in \mathbb{Z} \geq 0$	Univ. tight given by $(\mu, l)$ ; <sup>8</sup> $ n - 1 $ others, 2 of these universally tight <sup>9</sup>
	$-T^n, n > 0$	Circle bundle over Klein bottle	$(2m - 1)\pi, m \in \mathbb{Z}^+$	Univ. tight given by $\mu$ if $\mu$ odd; given by $(\mu, \pm)$ if $\mu$ even
	-id	Also Seifert $(\frac{1}{2}, \frac{1}{2}, -\frac{1}{2}, -\frac{1}{2})$	$(2m - 1)\pi, m \in \mathbb{Z}^+$	Univ. tight given by $(s, \mu)$ if $\mu$ odd; given by $(s, \mu, \pm)$ if $\mu$ even
	$-T^n, n < 0$	Circle bundle over Klein bottle	$(2m - 1)\pi, m \in \mathbb{Z}^+$	Univ. tight given by $\mu$ if $\mu$ odd; given by $(\mu, \pm)$ if $\mu$ even; 1 other, not univ. tight

## 1. Tight contact structures on $T^2 \times I$

**1.1. Review.** We will review some notions from [13]. For a more thorough discussion, the reader is referred to [13]. Consider an oriented convex surface  $\Sigma$  which is closed or with Legendrian boundary. Let  $\Gamma_\Sigma$  be the dividing set and  $\#\Gamma_\Sigma$  the number of connected components of  $\Gamma_\Sigma$ . If  $\Sigma$  has Legendrian boundary, we say a component  $\Sigma_i$  of  $\Sigma \setminus \Gamma_\Sigma$  is a  $\partial$ -parallel component, if  $\Sigma_i$  is a half-disk,  $\partial\Sigma_i = \alpha \cup \beta$ ,  $\alpha$  is a connected arc in  $\Gamma_\Sigma$ , and  $\beta \subset \partial\Sigma$  is a connected arc. The corresponding component  $\alpha$  of  $\Gamma_\Sigma$  is also called a  $\partial$ -parallel dividing curve. The *sign* of the  $\partial$ -parallel component is the sign of the singular set on the interior of  $\Sigma_i$ . Assume for simplicity that  $\Sigma_i$  is positive. There also exists a slightly larger half-disk  $D \supset \Sigma_i$ , called the *bypass half-disk* with  $\partial D = \alpha' \cup \beta'$ , where  $\alpha'$  is a connected Legendrian arc, all of whose singular points have the same sign  $-$ ,  $\beta' \subset \partial\Sigma$  is a connected Legendrian arc whose singular points are  $-$ ,  $+$ ,  $-$  (in that order), and  $\alpha'$  and  $\beta'$  meet only at their endpoints. (The endpoints of  $\alpha'$  (= endpoints of  $\beta'$ ) may overlap sometimes, when we have a *singular bypass*.)

**1.1.1. Classification.** Consider  $T^2 \times I$  with convex boundary  $\partial(T^2 \times I) = T_1 - T_0 = T \times \{1\} - T \times \{0\}$ . Assume for simplicity that the  $T_i$  are *minimal*, i.e.,  $\#\Gamma_{T_i} = 2$ . After choosing a convenient oriented identification  $T^2 \simeq \mathbb{R}^2/\mathbb{Z}^2$ , we may assume that  $T_1$  has slope  $-\frac{p}{q}$ , where  $p \geq q > 0$ , and  $T_0$  has slope  $-1$ . Here the slope is the slope of a linear curve on  $T^2$  which is isotopic to a dividing curve. Assume without loss of generality that the dividing curves are linear. Associate to  $-\frac{p}{q}$  its continued fraction representative  $(r_0, \dots, r_k)$ , where  $r_i \leq -2$  for all  $i$  (unless  $p = q = 1$ ), and

$$-\frac{p}{q} = r_0 - \frac{1}{r_1 - \frac{1}{r_2 - \dots - \frac{1}{r_k}}}.$$

For this boundary data, we have the following, which is proven in [13]:

**Theorem 1.1.** *Consider  $T^2 \times I$  with minimal convex boundary, and assume the slopes of the dividing curves on  $T_1$  are  $-\frac{p}{q}$ , and the slopes on  $T_0$  are  $-1$ . Assume we have fixed a characteristic foliation which is adapted to  $T_0$  and  $T_1$ .*

1.  $T^2 \times I$  has exactly  $|(r_0 + 1)(r_1 + 1) \cdots (r_{k-1} + 1)(r_k)|$  tight contact structures with minimal  $I$ -twisting. Here,  $r_0, \dots, r_k$  are the coefficients of the continued fraction expansion of  $-\frac{p}{q}$ .

2. For each  $n \in \mathbb{Z}^+$ , there exist exactly 2 tight structures on  $T^2 \times I$ , with  $n\pi \leq \beta_I < (n+1)\pi$ . These are universally tight.

The classification is up to isotopy.

The theorem does not depend on the precise characteristic foliation on  $T_0$  and  $T_1$  — the count only depends on the dividing curves. For this reason, we will often only refer to the dividing set  $\Gamma$  when we really mean a dividing set  $\Gamma$  together with a characteristic foliation  $\mathcal{F}$  which is adapted to  $\Gamma$ .

The first part of Theorem 1.1 is proved by factoring a tight contact manifold  $(T^2 \times [0, 1], \xi)$  into *basic slices*  $T^2 \times [\frac{i}{l}, \frac{i+1}{l}]$ ,  $i = 0, \dots, l-1$ , in a manner dictated by the continued fraction expansion of  $-\frac{p}{q}$  (using bypasses). More precisely, the slopes  $s_{\frac{i}{l}}$  of  $T_{\frac{i}{l}}$  are obtained successively from  $s_{\frac{i+1}{l}}$  by increasing the last entry of the corresponding continued fraction representative by 1, so that we start with  $s_1 = -\frac{p}{q}$  and end with  $s_0 = -1$ . Each basic slice is completely classified by the sign (+ or -) of the  $\partial$ -parallel components on a horizontal annulus from  $T_{\frac{i}{l}}$  to  $T_{\frac{i+1}{l}}$ , and we prove that all possible sign combinations are allowed as long as the slices in the factorization follow the pattern given by the continued fraction expansion and each slice is tight — this is done by embedding  $(T^2 \times I, \xi)$  inside a tight structure for a lens space, obtained by Legendrian surgery.

**1.1.2. Intrinsic interpretation.** Let us give a more intrinsic description of the layering, based on the standard (Farey) tessellation of the hyperbolic unit disk  $\mathbb{H}^2 = \{(x, y) | x^2 + y^2 \leq 1\}$ . A *basic slice*  $(T^2 \times I, \xi)$  is a tight contact structure with minimal convex boundary, minimal twisting, and boundary slopes  $s_1$  and  $s_0$  for which there exists an edge of the tessellation from  $s_1$  to  $s_0$ . This is equivalent to saying that there exist corresponding shortest integral vectors  $v_1, v_0$  which form an oriented integral basis. There exist two possibilities for  $\xi$  up to isotopy rel boundary.

Consider a minimally twisting tight contact structure  $(T^2 \times I, \xi)$  with minimal convex boundary and slopes  $s_1$  and  $s_0$ . We have a factorization into basic slices  $T^2 \times [\frac{i}{l}, \frac{i+1}{l}]$ ,  $i = 0, \dots, l-1$ , where  $s_1 < s_{\frac{l-1}{l}} < s_{\frac{l-2}{l}} < \dots < s_0$ . Here, consider the counterclockwise arc  $[s_1, s_0] \subset \partial\mathbb{H}^2$ , and write  $a < b$  if  $b$  is closer to  $s_0$  than  $a$  on  $[s_1, s_0]$ . The sequence of slopes  $s_{\frac{i}{l}}$  is the shortest counterclockwise sequence of slopes from  $s_1$  to  $s_0$ , where each consecutive pair represents an edge of the tessellation.

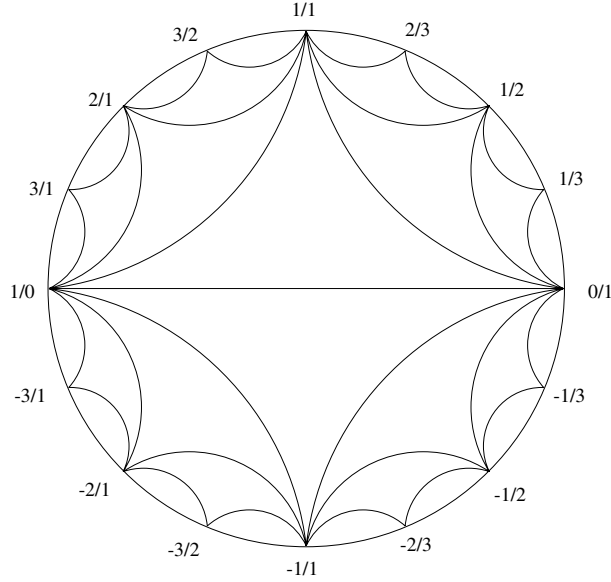

Figure 1: The standard tessellation of the hyperbolic unit disk.

Define a *continued fraction block* to be a maximal union of basic slices  $T^2 \times [\frac{l_1}{l}, \frac{l_1+1}{l}], \dots, T^2 \times [\frac{l_2-1}{l}, \frac{l_2}{l}]$ , so that the corresponding shortest integer vectors  $v_{\frac{l_1}{l}}, \dots, v_{\frac{l_2}{l}}$  satisfy  $\det(v_{\frac{l_1}{l}}, v_{\frac{l_1+i}{l}}) = \pm i$ . In terms of the tessellation, this means that  $s_{\frac{l_1}{l}} < \dots < s_{\frac{l_2}{l}}$  satisfy the following. Given  $s_{\frac{l_2}{l}}, s_{\frac{l_2-1}{l}}$ , there is a unique  $s'$  not on  $[s_{\frac{l_2}{l}}, s_{\frac{l_2-1}{l}}]$  which forms an ideal triangle in the tessellation with  $s_{\frac{l_2}{l}}$  and  $s_{\frac{l_2-1}{l}}$ . Then  $s_{\frac{l_2-2}{l}}$  must be the unique point on  $[s_{\frac{l_2-1}{l}}, s']$  which forms an ideal triangle with  $s_{\frac{l_2-1}{l}}$  and  $s'$ . The subsequent terms are determined similarly.

The following proposition will also be used tacitly but frequently in this paper:

**Proposition 1.2.** *Let  $(T^2 \times I, \xi)$  be tight with convex boundary, and let  $s_0, s_1$  be the boundary slopes. Given any  $s$  between  $s_1$  and  $s_0$ , there exists a convex torus parallel to  $T^2 \times \{pt\}$  with slope  $s$ .*

**1.1.3. Relative Euler class.** Consider a tight  $(M, \xi)$  with convex boundary  $\partial M$ . Assume  $\xi|_{\partial M}$  is trivializable, and choose a nowhere zero section  $s$  of  $\xi$  on  $\partial M$ . Then we may form the *relative Euler class*  $e(\xi, s) \in H^2(M, \partial M; \mathbb{Z}) = H_1(M; \mathbb{Z})$ . If  $\partial M$  is a union of convex tori, then we take the tori to be in *standard form*, and let  $s$  be given by the

tangent field of the Legendrian rulings.

For  $M = T^2 \times I$ , we identify  $H_1(M; \mathbb{Z}) \simeq \mathbb{Z}^2$ , and the Euler class  $e(\xi, s)$  is an element of  $\mathbb{Z}^2$ . If  $(T^2 \times I, \xi)$  is a basic slice with slopes  $s_1, s_0$ , then there are two possibilities for  $e(\xi, s)$ , namely  $\pm(v_1 - v_0)$ , where  $v_1, v_0$  are the shortest integer vectors forming an oriented  $\mathbb{Z}$ -basis of  $\mathbb{Z}^2$ . (Here we need to make a choice of  $v_1$ ; then  $v_0$  is determined.) Once a choice of  $v_1$  is made, we say that a basic slice is *positive* (resp. *negative*) if  $e(\xi, s) = +(v_1 - v_0)$  (resp.  $-(v_1 - v_0)$ ). In general, for a minimally twisting  $(T^2 \times I, \xi)$ ,  $e(\xi, s)$  is the sum of the Euler classes of the basic slices given by the decomposition in Section 1.1.2.

**1.1.4. Gluing toric annuli.** The following Gluing Theorem is found in Section 4.7 of [13]. It allows us to determine whether tightness is preserved when we glue two  $T^2 \times I$  together.

**Theorem 1.3** (Gluing Theorem, Intrinsic Version). *Let  $\xi$  be a contact structure on  $T^2 \times [0, n]$ , where each  $N_i = T^2 \times [i, i+1]$  is a basic slice. Assume all  $s_i$  lie on the counterclockwise arc  $[s_n, s_0] \subset \partial\mathbb{H}^2$ , and  $s_n < s_{n-1} < s_{n-2} < \dots < s_0$ . Here we write  $a < b$  if  $b$  is closer to  $s_0$  than  $a$  is on the arc  $[s_n, s_0]$ . Then  $\xi$  is tight if and only if one of the following holds:*

1.  $s_n, s_{n-1}, \dots, s_0$  is the shortest sequence from  $s_n$  to  $s_0$ .
2.  $s_n, \dots, s_0$  is not the shortest sequence and there is a triple  $s_{i+1}, s_i, s_{i-1}$  where  $s_i$  is removable from the sequence, i.e., there exists an edge from  $s_{i+1}$  to  $s_{i-1}$  along  $\partial\mathbb{H}^2$ .  $T^2 \times [i-1, i+1]$  is a basic slice (i.e., the signs of the basic slices  $T^2 \times [i-1, i]$  and  $T^2 \times [i, i+1]$  are the same) and we shorten the sequence by omitting  $s_i$ . By repeating this procedure we get to Case (1).

A useful formulation for determining whether a glued-up contact structure is tight is the following:

**Corollary 1.4** (Gluing Theorem, Non-Intrinsic Version). *Let  $\xi$  be a contact structure on  $M = T^2 \times [0, 2]$ , with minimal convex boundary. Assume  $\xi$  is tight on each of  $M_1 = T^2 \times [0, 1]$  and  $M_2 = T^2 \times [1, 2]$ , and  $M_1, M_2$  have minimal convex boundary with boundary slopes  $s_2 = -\frac{p}{q}$ ,  $s_1 = -\frac{p'}{q'}$ ,  $s_0 = -1$ , and minimal twisting. Here  $s_i$  is the slope of the dividing curves of  $T^2 \times \{i\}$ . Let  $-\frac{p}{q}$  have continued fraction representative  $(r_0, \dots, r_{k-1}, r_k, \dots, r_l)$  and  $-\frac{p'}{q'}$  have continued fraction representative  $(r_0, \dots, r_{k-1}, r'_k)$ , where  $r'_k > r_k$ . Then  $\xi$  is tight on  $M$ .*

**1.2. Overtwisted covers of  $T^2 \times I$ .** As an application of the Gluing Theorem we indicate an algorithm to determine whether a given cover of a tight contact manifold  $(T^2 \times I, \xi)$  is overtwisted.

Given a minimally twisting tight  $\xi$  on  $T^2 \times I$  with minimal boundary, there exists a decomposition into basic slices  $L_1, \dots, L_l$ , dictated by the continued fraction pattern, where  $L_i = T^2 \times [\frac{i-1}{l}, \frac{i}{l}]$ , and  $s_{\frac{i}{l}} = \frac{p_i}{q_i}$ ,  $(p_i, q_i) = 1$ . Let us consider an  $(m \times n)$ -fold cover

$$\widetilde{T^2 \times I} = \mathbb{R}^2 / (m\mathbb{Z} \times n\mathbb{Z}) \times I,$$

together with the lift  $\tilde{\xi}$ . The  $L_i$  will have covers  $\tilde{L}_i$  with boundary slopes  $\tilde{s}_{\frac{i}{l}} = \frac{mp_i}{nq_i}$ . Also let  $s'_0, \dots, s'_l$  be the slopes of boundaries of the basic slices for  $\widetilde{T^2 \times I}$ , dictated by the continued fraction expansion.

**Proposition 1.5.**  *$\tilde{\xi}$  is tight if and only if the following conditions are met:*

1. *If there exist  $\tilde{s}_{\frac{i}{l}}, \dots, \tilde{s}_{\frac{j+k}{l}}$  between  $s'_i$  and  $s'_{i-1}$ , then all the slices  $L_j, \dots, L_{j+k+1}$  must have the same sign, in the case  $s'_i \neq \tilde{s}_{\frac{j+k}{l}}$  and  $s'_{i-1} \neq \tilde{s}_{\frac{i}{l}}$ . If  $s'_i = \tilde{s}_{\frac{j+k}{l}}$ , then we omit  $L_{j+k+1}$ , and if  $s'_{i-1} = \tilde{s}_{\frac{i}{l}}$ , then we omit  $L_j$ .*
2. *If  $(mp_j, nq_j) \neq 1$ , then  $L_j$  and  $L_{j+1}$  have the same sign.*

The proof is a straightforward consequence of the Gluing Theorem. (1) is required because  $\tilde{\xi}$  must respect the continued fraction pattern, and (2) is a provision in case there is an increase in the dividing number if  $mp_j$  and  $nq_j$  are not relatively prime.

**Example.** Consider  $T^2 \times I$ , with minimally twisting tight contact structure  $\xi$  which is layered so that the boundary slopes  $s_{\frac{i}{3}}$  are  $-\frac{7}{2}, -3, -2, -1$ , with signs  $-, +, +$ . (By this we mean the slice from  $-\frac{7}{2}$  to  $-3$  has sign  $-$ , the slice from  $-3$  to  $-2$  has sign  $+$ , etc.)

(a) (1, 2)-cover. Then the slopes  $\tilde{s}_{\frac{i}{3}}$  become  $-\frac{7}{4}, -\frac{3}{2}, -\frac{2}{2} = -1, -\frac{1}{2}$ . Condition (2) of Proposition 1.5 is met. The boundary slopes  $s'_i$  of the slices of the cover are  $-\frac{7}{4}, -\frac{5}{3}, -\frac{3}{2}, -1, -\frac{1}{2}$ , so condition (1) is met. Therefore, this cover is tight.

(b) (1, 3)-cover. The  $\tilde{s}_{\frac{i}{3}}$  are  $-\frac{7}{6}, -\frac{3}{3} = -1, -\frac{2}{3}, -\frac{1}{3}$ . Condition (2) is not met, so this cover is overtwisted.

(c) (1, 4)-cover. The  $\tilde{s}_{\frac{i}{3}}$  are  $-\frac{7}{8}, -\frac{3}{4}, -\frac{2}{4} = -\frac{1}{2}, -\frac{1}{4}$ . Condition (2) is met at  $-\frac{1}{2}$ . The boundary slopes  $s'_i$  are  $-\frac{7}{8}, -\frac{6}{7}, -\frac{5}{6}, -\frac{4}{5}, -\frac{3}{4}, -\frac{2}{3}, -\frac{1}{2}, -\frac{1}{3}, -\frac{1}{4}$ , so condition (1) is met. This cover is tight.

(d) (1, 5)-cover. The  $\tilde{s}_{\frac{i}{3}}$  are  $-\frac{7}{10}, -\frac{3}{5}, -\frac{2}{5}, -\frac{1}{5}$ . Condition (2) is now vacuous. The boundary slopes  $s'_i$  are  $-\frac{7}{10}, -\frac{2}{3}, -\frac{1}{2}, -\frac{1}{3}, -\frac{1}{4}, -\frac{1}{5}$ , and the layer between  $-\frac{2}{3}$  and  $-\frac{1}{2}$  has a problem. This cover is overtwisted.

**Exercise.** Consider the lens space  $M = L(p, q)$ , where  $p \geq 3$  and  $q < p - 1$ . Then exactly two tight contact structures on  $M$  will lift to the unique tight contact structure on  $\widetilde{M} = S^3$ . (In other words, if there is a mixing of sign, then the tight contact structure is virtually overtwisted.)

**Question.** Although we have provided an algorithm for determining whether a given cover is overtwisted, it would be much more satisfactory if we could enumerate exactly which covers are overtwisted. Is it possible to give such a count?

## 2. Classification on $T^2$ -bundles over $S^1$

**2.1. Conjugacy classes of  $\mathrm{SL}(2, \mathbb{Z})$ .** In this section we will choose suitable representatives of each conjugacy class of  $\mathrm{SL}(2, \mathbb{Z})$ . Let  $S = \begin{pmatrix} 0 & 1 \\ -1 & 0 \end{pmatrix}$ , and  $T = \begin{pmatrix} 1 & 1 \\ 0 & 1 \end{pmatrix}$ .

**Lemma 2.1.** *Every conjugacy class of  $\mathrm{SL}(2, \mathbb{Z})$  can be represented by one of the following:*

1.  $A = \pm S$ .  $\mathrm{tr}(A) = 0$ .
2.  $A = \pm T^{-1}S, \pm(T^{-1}S)^2$ .  $|\mathrm{tr}(A)| = 1$ .
3.  $A = \pm T^n$ ,  $n \in \mathbb{Z}$ .  $|\mathrm{tr}(A)| = 2$ .
4.  $A = \pm T^{r_0} S T^{r_1} \cdots T^{r_k} S$ ,  $r_i \leq -2$ ,  $r_0 < -2$ .  $|\mathrm{tr}(A)| > 2$ .

*Proof.* We will work in  $\mathrm{PSL}(2, \mathbb{Z})$ , which is a free product  $\mathbb{Z}/2\mathbb{Z} * \mathbb{Z}/3\mathbb{Z}$ , where  $\mathbb{Z}/2\mathbb{Z}$  is generated by  $S$  and  $\mathbb{Z}/3\mathbb{Z}$  is generated by  $T^{-1}S$ . Write  $A \sim B$  if  $A$  and  $B$  are conjugate. If  $A \neq \mathrm{id}$  or  $S$ , then  $A \sim T^{r_0} S T^{r_1} S \cdots T^{r_k} S$  or  $A \sim T^{r_0}$ , where  $r_i \leq -1$ .

Consider the case  $A \sim T^{r_0} S T^{r_1} S \cdots T^{r_k} S$ . If one of the  $r_i = -1$ , then we may assume that  $r_0 = -1$ , after permutation. Then,

$$\begin{aligned} T^{-1} S T^{r_1} S \cdots T^{r_k} S &= (T^{-1} S T^{-1}) T^{r_1+1} S \cdots T^{r_k+1} (T^{-1} S) \\ &\sim T^{r_1+1} S \cdots T^{r_k+1} S, \end{aligned}$$

unless  $A = T^{-1} S$  or  $(T^{-1} S)^2$  already. This reduces the length of our string, and we continue if necessary to obtain  $r_i < -1$ , or  $A = S, T^{-1} S$ , or  $(T^{-1} S)^2$ .

If  $r_i = -2$  for all  $i$ , then

$$\begin{aligned} (T^{-2} S)^n &= T^{-2} S T^{-2} S \cdots T^{-2} S \sim (T^{-1} S T^{-1})^n \\ &= (S T S)^n = S T^n S \sim T^n, \end{aligned}$$

$n > 0$ . The remaining situation is when not all  $r_i = -2$ . In this case, we set  $r_0 < -2$ . The representation is not unique in the last case.  $\square$  e.d.

Let the  $T^2$ -bundle  $M$  over  $S^1$  be represented by  $(T^2 \times I) / \sim$  as before, where the monodromy map  $A \in SL(2, \mathbb{Z})$  is listed in Lemma 2.1. Cut  $M$  along a convex torus  $\Sigma$  in standard form, isotopic to a fiber  $T^2$ , and with minimal possible number of dividing curves, and call the resulting manifold  $T^2 \times I$ .  $T^2 \times I$  will have boundary slopes  $s_0, s_1$ . If  $s_0 \neq s_1$  or the  $I$ -twisting is non-minimal, then we may assume that  $\Sigma$  is minimal, i.e., it has exactly 2 dividing curves. In fact, if  $\Sigma$  has more than 2 dividing curves, then we can find a  $\partial$ -parallel component for  $\Sigma$  to obtain  $\Sigma'$  which has fewer dividing curves but the same slopes.

Consider the lifting  $(M, \xi)$  to  $(\widetilde{M} = T^2 \times \mathbb{R}, \tilde{\xi})$ . Define  $\tilde{\xi}_{t_0} = \phi_{t_0}^* \tilde{\xi}$ , where  $\phi_{t_0} : \widetilde{M} \rightarrow \widetilde{M}$  is the translation  $(\mathbf{x}, t) \mapsto (\mathbf{x}, t + t_0)$ , and let  $\xi_{t_0}$  be the pushforward to  $M$ . We therefore have a 1-parameter family  $\xi_t$ ,  $t \in \mathbb{R}$ , of contact structures on  $M$ , and they are all contact isotopic by Gray's theorem. Therefore, if  $\widetilde{\Sigma}' \subset \widetilde{M}$  is a lift of another convex torus  $\Sigma' \in M$ , where  $\Sigma'$  is parallel to  $\Sigma$ , then we may replace  $\Sigma$  by  $\Sigma'$  and use the slope of  $\widetilde{\Sigma}'$  instead. In other words, there is some freedom in choosing the boundary slopes of  $T^2 \times I$ , and we exploit this freedom to standardize the boundary slopes by looking inside  $\widetilde{M} = T^2 \times \mathbb{R}$ . Note, however, that, at this point, we do not know whether  $\tilde{\xi}$  is tight.

**2.2. Non-minimal twisting.** If the tight structure  $\xi$  on  $T^2 \times I$  has non-minimal  $I$ -twisting  $\beta_I$ , then it must be universally tight by the classification (Theorem 1.1). Since  $\xi$  has non-minimal  $I$ -twisting, we may assume  $\Sigma$  is minimal. Now glue copies of  $T^2 \times I$  to obtain  $\widetilde{M} = T^2 \times \mathbb{R}$ , together with  $\tilde{\xi}$ .



First consider the situation where  $\tilde{\xi}$  remains tight. In this case we may take  $s_1 = 0$ .  $\tilde{\xi}$  is tight exactly when

- (i)  $n = 2m$ ,  $m \in \mathbb{Z}^+$ , where  $n\pi \leq \beta_I < (n+1)\pi$ , in case the angle from  $(1,0)^T$  to  $A(1,0)^T$  is  $0 \leq \alpha < \pi$ , and
- (ii)  $n = 2m + 1$ ,  $m \in \mathbb{Z}^{\geq 0}$ ,  $n\pi \leq \beta_I < (n+1)\pi$ , in case  $\pi \leq \alpha < 2\pi$ .

In other words, roughly half of the tight structures on  $T^2 \times I$  with non-minimal twisting survive passage to  $T^2 \times \mathbb{R}$ . The reader may easily verify this claim using the Gluing Theorem. These all appear in Giroux's paper [9] — they are called  $\zeta_m$  there — and are classified (up to diffeomorphism) by  $\beta_{S^1} = n\pi$ . Although there existed two tight structures on  $T^2 \times I$  with  $n\pi \leq \beta_I < (n+1)\pi$ , up to isotopy, the two tight structures become isotopic when the boundaries are glued — this is because, instead of splitting  $M$  along  $\Sigma$  to obtain  $T^2 \times I$ , we could have split along a minimal  $\Sigma'$  with  $s = 0$ , parallel to and disjoint from  $\Sigma$ , for which the  $T^2 \times I$  bounded by  $\Sigma$  and  $\Sigma'$  has  $\beta_I = \pi$ . This process is equivalent to taking one of the tight contact structures on  $T^2 \times I$  with  $n\pi \leq \beta_I < (n+1)\pi$  and acting on it by  $-\text{id} \times \text{id}$ , where  $-\text{id}$  acts on the first factor  $T^2 \simeq \mathbb{R}^2/\mathbb{Z}^2$ , to get the other tight contact structure on  $T^2 \times I$  with  $n\pi \leq \beta_I < (n+1)\pi$ .

These universally tight contact structures  $\zeta_m$  can be written more explicitly as given by the following 1-form on  $(T^2 \times \mathbb{R})/\sim$ :

$$\alpha_m = \sin(\phi(t))dx + \cos(\phi(t))dy,$$

with  $\phi'(t) > 0$ ,  $n\pi \leq \sup_{t \in \mathbb{R}}(\phi(t+1) - \phi(t)) < (n+1)\pi$ , and  $\alpha_m$  invariant under the action  $(\mathbf{x}, t) \mapsto (A\mathbf{x}, t - 1)$ .

Next we consider the situation where  $\xi$  on  $T^2 \times I$  has non-minimal twisting and is universally tight as before, and induces a tight structure (also call it  $\xi$ ) on  $M$  after gluing, yet  $\tilde{\xi}$  on  $\tilde{M}$  is overtwisted. If  $\beta_I > \pi$ , then consider a small layer  $T^2 \times [1 - \delta, 1]$ ,  $\delta > 0$  small, with boundary slopes  $s_1$  and  $s_1 + \varepsilon$ , where  $\varepsilon$  is a small rational number and  $\beta_I(T^2 \times [0, 1 - \delta]) > \pi$ . Map it under  $A$  to get a layer  $T^2 \times [-\delta, 0]$  with slopes  $As_1 = s_0$  and  $A(s_1 + \varepsilon)$ . There also exists a minimally twisting layer  $T^2 \times [0, 1 - \delta']$ ,  $\delta' > \delta$ , with boundary slopes  $A(s_1 + \varepsilon)$  and  $s_0$ . The composite  $T^2 \times [-\delta, 1 - \delta']$  of the two layers has  $\pi$ -twisting, and will give an overtwisted disk in  $\xi$  on  $M$  unless we have (i) or (ii) above because of the compatibility required in the Gluing Theorem. The exception is when  $\beta_I = \pi$  and  $\alpha = 0$  ( $\alpha$  is the angle discussed in (i), (ii) above), which is the case when  $A = T^n$ . We take  $s_1 = s_0 = 0$  and  $\beta_I = \pi$ . If

$n < 2$ , then the glued contact structure  $\xi$  on  $M$  is overtwisted by the Gluing Theorem. This is done by cutting  $T^2 \times I$  into two slices and moving the front slice to the back via  $A$ . If  $n \geq 2$ , then we start with the two distinct tight contact structures on  $T^2 \times I$  with boundary slopes  $s_0 = s_1 = 0$  and glue via  $A = T^n$ . We then have the following:

**Lemma 2.2.** *The two contact structures remain tight. They are distinct if  $n > 2$ .*

The proof will be given in the next section after we discuss a new, general method called *state traversal* which allows us to determine whether a given contact structure is tight. Summarizing, we have:

**Proposition 2.3** (Classification in the non-minimal-twisting case). *For a torus bundle  $M$  with monodromy  $A$ , there exist infinitely many tight contact structures with non-minimal twisting. The universally tight contact structures are distinguished by the  $S^1$ -twisting  $\beta_{S^1}$  which take values in  $[n\pi, (n+1)\pi)$  for  $n = 2m$ ,  $m \in \mathbb{Z}^+$ , or  $n = 2m+1$ ,  $m \in \mathbb{Z}^{\geq 0}$ , depending on the actual value of  $A$ . There exist virtually overtwisted contact structures only when  $A = T^n$ ,  $n > 1$ , and there is one for  $n = 2$  and two for  $n > 2$ .*

### 2.3. State traversal.

**2.3.1. Description of the method.** Consider a decomposition of a 3-manifold  $N = N_1 \cup \cdots \cup N_k$ , where each  $N_i$  is irreducible, each boundary component of  $N_i$  is incompressible, and on each  $N_i$  it is possible to determine whether a given contact structure  $\xi|_{N_i}$  is tight. Let  $\mathcal{W} = \cup_{i=1}^k (\partial N_i)$ ; components  $W$  of  $\mathcal{W}$  are called ‘walls’. We assume  $\mathcal{W}$  is convex.

Fix a contact structure  $\xi$  on  $N$  and define a *state* to be a collection  $\{(N_i, \xi_i) | i = 1, \dots, k\}$ , where  $\xi_i$  is a contact structure on  $N_i$ , and the contact structures glue to form a contact structure isotopic to  $\xi$  on  $N$ . The state is called a *tight state* if each of the  $\xi_i$  are tight. Given a tight state and an overtwisted disk  $D \subset N$ , we describe a process to obtain other states and an overtwisted disk  $D'$  with strictly fewer intersections with  $\mathcal{W}$ . To show that  $\xi$  is tight we start with a tight state and show that all states that can be obtained from this state are also tight states (thus eventually pushing the overtwisted disk into one of the tight  $(N_i, \xi_i)$ ’s and contradicting the existence of  $D$ ).

Start with an *initial state* where  $\xi|_{N_i}$  is tight for each  $i$ . If there is a candidate overtwisted disk  $D \subset N$  which does not intersect any of the walls, then we have a contradiction because each  $\xi|_{N_i}$  must be tight.

Therefore,  $D \cap \mathcal{W}$  is a nonempty union of arcs with endpoints on  $\partial D$ , as well as closed curves. If we view  $D \cap \mathcal{W}$  on  $D$ , then there must exist an ‘innermost’ closed curve or an ‘outermost’ arc. An innermost closed curve  $\gamma$  is a closed curve of  $D \cap \mathcal{W}$  which bounds a disk  $D_1 \subset D$  so that  $D_1$  has no other intersections with  $\mathcal{W}$ . An outermost arc  $\alpha$  cuts off a half-disk  $D_1 \subset D$  with  $\partial D_1 = \alpha \cup \beta$  and  $\beta \subset \partial D$ , subject to the condition that  $D_1$  has no other intersections with  $\mathcal{W}$ .

First consider an innermost closed curve  $\gamma$ . Since  $\mathcal{W}$  is incompressible,  $\gamma$  bounds a disk  $D_2$  in a component  $W$  of  $\mathcal{W}$ . Then  $D_1 \cup D_2$  is a sphere which necessarily bounds a 3-ball  $B$  because of the irreducibility of  $N_i$ . Consider  $W \times I$ , where  $W \times \{0\} = W$  and  $W \times I$  is a slightly thickened  $W \cup B$  so that  $W \times I$  has convex boundary. Next, if  $\alpha$  is an outermost arc, then let  $W \times I$  be a slightly thickened  $W \cup D_1$ . In either case it is possible to make  $W \times \{1\}$  convex without affecting the isotopy type of  $D \cap W$ , with the exception of  $D \cap (W \times \{1\})$  having strictly fewer intersections. This is because a  $C^\infty$ -small perturbation of  $W \times \{1\}$  is convex, and if  $D$  is transverse to  $W \times \{1\}$ , the isotopy type of  $D \cap (W \times \{1\})$  will not change under a  $C^\infty$ -small perturbation of either surface. We now remove  $W \times I$  from the component  $N_i$  and attach it to another component  $N_j$  so that  $W \times \{1\}$  is now part of the new wall. If  $\xi$  on  $(W \times I) \cup N_j$  is overtwisted, then we are done. If  $\xi$  on  $(W \times I) \cup N_j$  is tight, then we keep proceeding until  $D$  has no more intersection with  $\mathcal{W}$ . Therefore, by ‘traversing all possible states’ which can be gotten from the initial state, we can determine whether a contact structure is tight.

**Remark.** This procedure is usually not finite.

**2.3.2. Application.** The following is the first application of the *state traversal* method. There will be another (much more involved) application in Part 2.

*Proof of Lemma 2.2.* Observe that if  $M$  is the torus bundle with monodromy  $A = T^n$ ,  $n \geq 2$ , the fiber torus  $\mathcal{W} = T^2 \times \{\text{pt}\}$  is incompressible and  $M$  is irreducible. The *initial state* is given by taking the cutting surface  $T^2 \times \{1\}$  to be convex, minimal, and with boundary slope  $s_1 = 0$  (hence  $s_0 = 0$ ), and the tight contact structure to be one of the two possible (universally) tight contact structures on  $T^2 \times I$  with  $\beta_I = \pi$  and  $e(\xi, s) = \pm(2, 0)$ .

In this case the *state transitions* consist of factoring  $T^2 \times [0, 1]$  into  $(T^2 \times [0, \frac{1}{2}]) \cup (T^2 \times [\frac{1}{2}, 1])$  and moving  $T^2 \times [\frac{1}{2}, 1]$  ‘to the back’ via  $A$  and evaluating whether the contact structure on  $(T^2 \times [-\frac{1}{2}, 0]) \cup (T^2 \times [0, \frac{1}{2}])$

is tight. (If the contact structure is tight, we will reset the coordinates so that  $T^2 \times [-\frac{1}{2}, \frac{1}{2}]$  becomes  $T^2 \times [0, 1]$ .)

We will examine the first state transition in some detail. There are two possibilities: either  $s_{\frac{1}{2}} = s_1$  and  $\#\Gamma$  changes, or  $s_{\frac{1}{2}} \neq s_1$ . In the latter case, we may assume  $-\infty < s_{\frac{1}{2}} = -\frac{p}{q} \leq -1$ ,  $p, q \in \mathbb{Z}^+$  (after conjugating via  $T^k$  for some  $k \in \mathbb{Z}$ ). Moving  $T \times [\frac{1}{2}, 1]$  to  $T \times [-\frac{1}{2}, 0]$ , we get  $s_{-\frac{1}{2}} = \frac{p}{-q+np}$  with  $0 < \frac{p}{-q+np} \leq 1$ . If we layer  $T \times [-\frac{1}{2}, \frac{1}{2}]$  using the Farey tessellation, we find that 0 will always be a boundary slope of a continued fraction block, except when  $n = 2$  and  $-\frac{p}{q} = -1$ . This can be seen as follows: For three successive slopes  $a_1, a_2, a_3 \in \mathbb{Q}$  in a Farey tessellation sequence to be slopes of a continued fraction block, we need the corresponding shortest integer vectors  $v_1, v_2, v_3$  to satisfy  $\det(v_1, v_2) = \det(v_2, v_3) = \pm 1$  and  $\det(v_1, v_3) = \pm 2$ . In the case we have slopes  $-\frac{a}{b}, 0, \frac{a'}{b'}$ , with  $a, b, a', b' \in \mathbb{Z}^+$ , this forces  $a = 1$ ,  $a' = 1$ , and  $b + b' = 2$  (and hence  $b = b' = 1$ ).

When  $n = 2$  and  $-\frac{p}{q} = -1$ , then the contact structure on  $T \times [-\frac{1}{2}, \frac{1}{2}]$  is tight, and we can shuffle the two layers ( $-1$  to  $0$  and  $0$  to  $1$ ) and interchange signs. Therefore, when  $n = 2$ , there is at most one tight structure up to isotopy, in contrast to  $n > 2$ , where the shuffling cannot take place.

Assume now that  $n > 2$ . Since 0 is a boundary slope of a continued fraction block, it is possible to glue together the tight structures on  $T^2 \times [0, \frac{1}{2}]$  and  $T^2 \times [-\frac{1}{2}, 0]$  into a contact structure which is tight, using (an invariant version of) the Gluing Theorem. Notice that the signs between  $-\frac{p}{q}$  and 0 are the same and the signs between 0 and  $\frac{p'}{q'}$  are the same, and the two groups have opposite sign.

Consider the case where  $s_{\frac{1}{2}} = s_1$  and  $\#\Gamma$  changes. There is a unique factorization of  $T^2 \times [0, \frac{1}{2}] = (T^2 \times [0, \frac{1}{4}]) \cup (T^2 \times [\frac{1}{4}, \frac{1}{2}])$  where the first layer is rotative with  $\#\Gamma_{T^2 \times \{\frac{1}{4}\}} = 2$ , and the second is a non-rotative layer which increases the dividing number (see Section 5.3 of [13]). This peeling and reattachment clearly preserves tightness.

Reset the coordinates on  $\mathbb{R}$  so that the toric annulus is called  $T \times [0, 1]$  again, and repeat, using the following inductive assumption:

1. The contact structure on  $T^2 \times [0, 1]$  is tight.
2.  $T^2 \times \{0, 1\}$  are convex,  $s_0 = \frac{p}{-q+np}$ , and  $s_1 = -\frac{p}{q}$ , where  $-\infty < -\frac{p}{q} \leq -1$ .
3. The tight contact structure on  $T^2 \times [0, 1]$  is minimally twisting,

and can be factored into  $T^2 \times [0, \frac{1}{2}]$  and  $T^2 \times [\frac{1}{2}, 1]$ , where  $s_{\frac{1}{2}} = 0$ , each layer is universally tight, and the layers have opposite signs (i.e.,  $e(\xi, s) = (-q + np, p) - (1, 0)$  and  $(q, -p) - (1, 0)$ , or both signs reversed).

4.  $T_0$  and  $T_1$  may not be minimal.

The argument is identical to that for the initial state. The only difference is when  $s_{\frac{1}{2}} = s_1$  and  $\#\Gamma$  is reduced. The resulting  $T^2 \times I$  remains tight, because of the unique factorization into rotative and non-rotative layers, mentioned above, which essentially ‘remembers’ how the dividing numbers were increased, and forces dividing curve decreases to ‘undo’ the dividing number increases. This proves tightness.

When  $n > 2$ , the two tight contact structures can be distinguished by the Euler class unless  $n = 4$ . We instead give an argument in the spirit of the state transition method, which works for all  $n > 2$ . Let  $\Sigma = T^2 \times \{0\} \subset M$  be the convex torus in standard form in the splitting of  $M$  given above, for which  $\#\Gamma_\Sigma = 2$  and  $s(\Sigma) = 0$ . Let  $\Sigma'$  be another convex torus isotopic (but not contact isotopic) to  $\Sigma$  with  $\#\Gamma_{\Sigma'} = 2$  and  $s(\Sigma') = 0$ . We try to get from  $\Sigma$  to  $\Sigma'$  through a sequence of convex surfaces which arises from reducing the number of components of  $\Sigma \cap \Sigma'$ . We may assume  $\Sigma \pitchfork \Sigma'$  and  $\Sigma \cap \Sigma'$  consists of parallel essential curves as well as homotopically trivial curves. The peeling and reattaching of  $T^2 \times I$  layers works in the same way as before. Suppose we have arrived at a state where  $s_1 = -\frac{p}{q}$ ,  $p, q \in \mathbb{Z}^+$ , and  $s_0 = \frac{p}{-q+np}$ . Let  $s_{\frac{1}{2}} = 0$  and  $\#\Gamma_{T^2 \times \{\frac{1}{2}\}} = 2$ . Once again, the key observation is that no layers can be interchanged between  $T^2 \times [0, \frac{1}{2}]$  and  $T^2 \times [\frac{1}{2}, 1]$ . Now let  $M' = M \setminus \Sigma$  and  $M'' = M \setminus \Sigma'$ . If we let  $s$  (resp.  $s'$ ) be a nonzero section of  $\xi|_\Sigma$  (resp.  $\xi|_{\Sigma'}$ ) given by the Legendrian rulings, then the relative Euler classes are  $e(\xi, M', s) = e(\xi, M'', s') = [\pm(2, 0)] \in H_1(T^2 \times I; \mathbb{Z}) = \mathbb{Z}^2$ . (See Section 4 in [13] for a discussion of the relative Euler class.) This proves that the two possible choices for  $\xi$  are not contact isotopic. q.e.d.

**2.4. The elliptic cases.** We now do a case-by-case analysis of the minimally twisting tight structures.

**Case 1.**  $A = -S$ .  $M$  is a Seifert fibered space over  $S^2$  with Seifert invariants  $(\frac{1}{2}, -\frac{1}{4}, -\frac{1}{4})$ . Since  $A$  is rotation by  $\frac{\pi}{2}$ ,  $s_0 = -\frac{1}{s_1}$ . Inside  $T^2 \times I$  there exist convex tori parallel to the boundary with slopes ranging from  $s_1$  to  $s_0$ , and, passing to the cover  $\widetilde{M}$ , we can obtain  $\Sigma$  with any desired slope because the twisting in the  $\mathbb{R}$ -direction is infinite. Pick  $\Sigma$  with

$s_0 = \infty$ ,  $s_1 = 0$ . There exist exactly two tight structures on  $T^2 \times I$  with boundary slopes  $\infty, 0$ , both universally tight. Gluing copies of  $T^2 \times I$  with this tight structure, we obtain  $\tilde{\xi}_i$ ,  $i = 1, 2$ , tight on  $\tilde{M}$ . Therefore, they are both universally tight, and are isotopic, using the same argument as the non-minimally twisting case. Therefore there is exactly one tight structure on  $M$  with minimal twisting.

**Case 2.**  $A = S$ .  $M$  is a Seifert fibered space over  $S^2$  with Seifert invariants  $(-\frac{1}{2}, \frac{1}{4}, \frac{1}{4})$ . We have two tight structures on  $T^2 \times I$  with boundary slopes  $0, \infty$  as before.

**Lemma 2.4.** *The tight contact structures remain tight after gluing. They are contact isotopic.*

*Proof.* The proof is almost identical to that of Lemma 2.2. If we peel off  $T^2 \times [\frac{1}{2}, 1]$  with  $s_{\frac{1}{2}} = -\frac{p}{q}$ ,  $p, q \in \mathbb{Z}^+$ , from  $T^2 \times I$  with slopes  $s_1 = 0$  and  $s_0 = \infty$ , and glue onto  $T^2 \times [-\frac{1}{2}, 0]$ , then  $s_{-\frac{1}{2}} = \frac{q}{p}$ . As before,  $0$  is a boundary slope for a continued fraction block, unless  $s_{\frac{1}{2}} = -1$ , so the contact structure on  $T^2 \times [-\frac{1}{2}, \frac{1}{2}]$  is tight by the Gluing Theorem. By repeated application of the peeling, we can engulf any candidate overtwisted disk inside a tight  $T^2 \times I$ , a contradiction. Notice that, no matter what the new  $s_{\frac{1}{2}}$  is, we can always transform using  $S$  to put  $-\infty \leq s_{\frac{1}{2}} < 0$ . This is because conjugation by  $S$  does not change the representative  $A = S$ .

If we chose  $s_{\frac{1}{2}} = -1$ ,  $s_{-\frac{1}{2}} = 1$ , then we could swap the layers and their signs. q.e.d.

**Case 3.**  $A = -T^{-1}S = \begin{pmatrix} -1 & -1 \\ 1 & 0 \end{pmatrix}$  or  $-(T^{-1}S)^2 = \begin{pmatrix} 0 & -1 \\ 1 & 1 \end{pmatrix}$ .

Let  $A = -T^{-1}S$ , which is essentially a  $\frac{2\pi}{3}$  rotation. The case  $A = -(T^{-1}S)^2$  (essentially a  $\frac{\pi}{3}$  rotation), works in the same fashion. Choose  $\Sigma$  so that  $s_0 = 0$ , and  $s_1 = -1$ . Again, there are two tight structures on  $T^2 \times I$ , which remain tight when copies of  $T^2 \times I$  are glued to obtain  $T^2 \times \mathbb{R}$ . These two tight structures become isotopic when the boundaries are identified. Therefore, there is exactly one minimally twisting tight structure on  $M$  up to isotopy. It is universally tight.

**Case 4.**  $A = T^{-1}S$  or  $(T^{-1}S)^2$ .  $A$  is essentially a  $-\frac{\pi}{3}$  or  $-\frac{2\pi}{3}$  rotation. We will show that there exist no minimally twisting tight structures if  $A = T^{-1}S$ . Cut along a  $\Sigma$  to obtain  $T^2 \times [0, 1]$  with boundary slopes  $s_0 = -1$  and  $s_1 = 0$ . There are two possible tight structures on this  $T^2 \times [0, 1]$ . Split  $T^2 \times [0, 1] = (T^2 \times [0, \frac{1}{2}]) \cup (T^2 \times [\frac{1}{2}, 1])$ ,

where  $T^2 \times \{\frac{1}{2}\}$  has  $s_{\frac{1}{2}} = \infty$ . If we now consider  $T^2 \times [-\frac{1}{2}, \frac{1}{2}]$ , then  $s_{-\frac{1}{2}} = 0$ ,  $s_{\frac{1}{2}} = \infty$ , yet  $T^2 \times [-\frac{1}{2}, 0]$  and  $T^2 \times [0, \frac{1}{2}]$  do not glue to give a tight structure because of sign incompatibilities as in the Gluing Theorem.

On the other hand, if  $A = (T^{-1}S)^2$ , then we may take  $s_1 = 0$ ,  $s_0 = \infty$ . Using the same argument as in Lemma 2.2, we find that the contact structures remain tight after gluing, and that two tight structures on  $T^2 \times I$  remain distinct after gluing.

**2.5. The parabolic cases.** Here we will treat the tight contact structures which are minimally twisting. When  $A$  is parabolic,  $M$  not only fibers over  $S^1$ , but is also fibered by  $S^1$  (the fiber  $S^1$ 's project to points on the base  $S^1$ ). This introduces new twisting directions, and hence gives rise to other universally tight contact structures which twist along the fiber  $S^1$ 's. When  $A = \pm \text{id}$ , there is even more symmetry, and hence more universally tight contact structures up to contact isotopy.

**Case 5.**  $A = T^n$ ,  $n > 0$ . If  $s_1 = \frac{b}{a}$ , with  $b > 0$ , then  $s_0 = \frac{b}{a+bn}$ , and there will always be a convex torus parallel to the boundary with slope  $s = 0$  between  $s_1$  and  $s_0$ . Therefore assume  $s_1 = s_0 = 0$ . If there is twisting, then the contact structure cannot be minimally twisting. This was already treated in Section 2.2. If there is no twisting, then  $\xi$  is determined up to isotopy by two invariants, the *minimum division number*, together with the *holonomy*. The *minimum division number*  $\mu \in \mathbb{Z}^+$  is the minimum, over convex tori  $\Sigma$  in standard form isotopic to the fiber  $T^2$ , and with slope  $s = 0$ , of  $\frac{1}{2}(\#\Gamma_\Sigma)$ . To define the *holonomy*, we cut the manifold  $M$  along  $\Sigma$  to obtain  $T^2 \times I$ , make the Legendrian rulings on the boundary vertical, and consider a vertical annulus  $\Sigma_0$  from  $T_0 = T^2 \times \{0\}$  to  $T_1 = T^2 \times \{1\}$  with Legendrian boundary. By the minimality of  $\mu$ ,  $\Sigma_0$  cannot have any  $\partial$ -parallel arcs, and we may assume that all the dividing curves of  $\Sigma_0$  cross from  $T_0$  to  $T_1$  and are parallel. Therefore, we may take  $\Sigma_0$  to be in standard form. Assume the  $T_i$ ,  $i = 1, 2$ , have dividing curves  $S^1 \times \{\frac{k}{2\mu}\}$ ,  $k = 0, \dots, 2\mu - 1$ , so that, for each  $k$ ,  $S^1 \times \{\frac{k}{2\mu}\} \times \{0\}$  is identified with  $S^1 \times \{\frac{k}{2\mu}\} \times \{1\}$ . Then the *holonomy* is  $l$ , if there exists a dividing curve on  $\Sigma_0$  with one endpoint on the interval  $0 < y < \frac{1}{2\mu}$  on  $T_1$  and the other endpoint on the interval  $\frac{2l}{2\mu} < y < \frac{2l+1}{2\mu}$  on  $T_0$ .

**Lemma 2.5.** *Given any  $\mu \in \mathbb{Z}^+$  and  $l \in \mathbb{Z}$ , there exists a tight contact structure  $\xi_{\mu,l}$  on  $M$  with minimum division number  $\mu$  and holonomy  $l$ . Moreover,  $(\mu, l)$  completely determines the isotopy class of  $\xi$  with no*

twisting in the  $S^1$ -direction.

*Proof.* It is easy to write down a tight structure which does not twist in the  $S^1$ -direction, and has invariants  $\mu, l$ . Take  $\xi_{\mu, l}$  given by

$$\alpha_{\mu, l} = \sin \left( 2\pi\mu \left( y + \frac{l}{\mu}t \right) \right) dx - \cos \left( 2\pi\mu \left( y + \frac{l}{\mu}t \right) \right) dt$$

on  $T^2 \times I$  with coordinates  $(x, y, t)$ . After modifying the Legendrian rulings on  $T_0$  and  $T_1$ , the boundary components can be identified via  $A$ .

We first show that  $\mu$  is indeed the minimum dividing number. If there exist  $\mu' < \mu$  and  $\Sigma'$  with slope  $s' = 0$  and dividing number  $\mu'$ , then we have a Legendrian curve  $\gamma$  isotopic to  $\{0\} \times S^1 \times \{0\}$  with twisting number  $-\mu'$  relative to the framing induced from the fiber  $T^2$ . However, this is impossible, using an argument which appears in Kanda's paper [14]: The  $\xi_{\mu, l}$  are universally tight, and we can pass to the cover  $\mathbb{R} \times S^1 \times \mathbb{R} \rightarrow M$ . For sufficiently large  $C \in \mathbb{Z}^+$ , there exists a lift  $\tilde{\gamma}$  of  $\gamma$  contained in  $N = [-C, C] \times S^1 \times [-C, C]$ . After rounding the corners of  $N$  (and still calling it  $N$ ),  $N$  becomes a solid torus with boundary slope  $-\frac{1}{\mu}$  and minimal boundary. The tight contact structure on the solid torus with this boundary slope and minimal boundary is unique, and, moreover, cannot contain a Legendrian isotopic to the core  $S^1$  with twisting number  $> -\mu$ . This proves that the minimum dividing number is indeed  $\mu$ .

Next we prove that the holonomy is indeed  $l$ . First consider the case where  $\Sigma$  is the same for  $\Sigma_0$  and  $\Sigma'_0$  (another vertical annulus from  $T_0$  to  $T_1$ ). If the holonomy  $l'$  of  $\Sigma'_0$  is not  $l$ , then pass to  $N = [-C, C] \times S^1 \times I \subset \mathbb{R} \times S^1 \times \mathbb{R} \rightarrow M$ , where  $C \in \mathbb{Z}^+$  and  $C \gg 0$ . If  $C$  is sufficiently large,  $N$  will contain a lift of  $\Sigma'_0$ , satisfying  $\Sigma'_0 \cap (\{\pm C\} \times S^1 \times I) = \emptyset$ .  $\{\pm C\} \times S^1 \times I$  both have holonomy  $l$ , so one of the components of  $N$  cut by  $\Sigma'_0$  will be a solid torus with boundary  $\frac{a}{\mu}$ ,  $a \geq 0$ , after rounding the corners. This implies the existence of a (vertical) Legendrian curve isotopic to  $\{\text{pt}\} \times S^1 \times \{\text{pt}\}$ , with twisting number 0 relative to the framing induced from a fiber  $T^2$ , which contradicts the minimality of  $\mu$ . Therefore,  $\Sigma$  is fixed; any other vertical annulus in standard form must have holonomy equal to  $l$ .

Now suppose there exists a  $\Sigma'$  isotopic to  $\Sigma$  with slope 0 and dividing number  $\mu$ , and  $M$ , cut along  $\Sigma'$ , has an annulus  $\Sigma'_0$  with holonomy  $l' \neq l$ . Then pass to  $N = [-C, C] \times S^1 \times [-C, C]$ , for  $C \in \mathbb{Z}^+$ ,  $C \gg 0$ , so that  $N$  contains two parallel lifts  $(\tilde{\Sigma}')_1, (\tilde{\Sigma}')_2$  of  $\Sigma'$  which are  $t = 1$  units apart. Take a lift of  $\Sigma'_0$ , and complete it to a vertical annulus from



$[-C, C] \times S^1 \times \{-C\}$  to  $[-C, C] \times S^1 \times \{C\}$ . (Assume all the Legendrian rulings of tori parallel to  $T^2$  have already been made vertical.) Then this annulus will have holonomy  $(2C - 1)l + l'$ , whereas the holonomy for  $\{\pm C\} \times S^1 \times [-C, C]$  is  $2Cl$ , and we obtain a contradiction from the previous case.

Finally we prove the latter claim. Prescribing  $(\mu, l)$  is equivalent to prescribing the torus  $T_0 = T_1$  with slope  $s = 0$  and  $\#\Gamma = 2\mu$ , as well as the vertical annulus  $\Sigma_0$  between  $T_0$  and  $T_1$ . Cut  $M$  along  $T_0$  and  $\Sigma_0$  and round the edges. This will give a solid torus with boundary slope  $-\frac{1}{\mu}$  which has a unique tight contact structure up to isotopy. q.e.d.

**Case 6.**  $A = -T^n$ ,  $n > 0$ . In this case, there is still a well-defined minimum dividing number  $\mu$ , but no well-defined holonomy. As before, we may take  $\Sigma$  in standard form with the minimum dividing number  $\mu$  and  $\Gamma_\Sigma = \cup_{k=0, \dots, 2\mu-1} (S^1 \times \{\frac{k}{2\mu}\})$ . Then, via  $A$ ,  $S^1 \times \{\frac{k}{2\mu}\}$  on  $T_0$  is identified with  $S^1 \times \{-\frac{k}{2\mu}\}$  on  $T_1$ ,  $k = 0, \dots, 2\mu - 1$ . It is possible to define the holonomy  $l$  on the cut-open manifold  $T^2 \times I$  as in Case 5. Namely, say the holonomy is  $l$  if there exists a vertical annulus  $\Sigma_0 = \{0\} \times S^1 \times I$  as before with dividing curves which connect from  $(0, \frac{a}{4\mu}, 1)$  to  $(0, \frac{4l+a+2}{4\mu}, 0)$ ,  $a$  odd. However, there are no well-defined  $\mathbb{Z}$ -valued levels or reference points to define a holonomy on  $M$ . This is because if we shift  $T_1$  ‘up’ (i.e., in the direction of  $\{\text{pt}\} \times S^1$ ) by  $\frac{b}{\mu}$ ,  $b \in \mathbb{Z}$ , we must also shift  $T_0$  ‘down’ by  $\frac{b}{\mu}$  at the same time. Consider the Klein bottle  $\Sigma'_0 = \Sigma_0 / \sim$ , where  $(0, y, 1) \sim (0, y, 0)$ , and the glued-up dividing set  $\Gamma'$ .  $\Gamma'$  will have exactly two closed curves which intersect  $\Sigma$  once (the others intersect  $\Sigma$  twice). If  $\mu$  is odd, then the two curves will intersect components of  $\Sigma \setminus \Gamma_\Sigma$  of opposite sign. (One will pass through a component of  $R_+$  and another will pass through a component of  $R_-$ , where  $R_+$  (resp.  $R_-$ ) consists of components of  $\Sigma \setminus \Gamma_\Sigma$  where the orientation on  $\Sigma$  coincides with (resp. is opposite to) the normal orientation of  $\xi$ .) If  $\mu$  is even, the two curves will intersect components of the same sign. Therefore, if  $\mu$  is odd, there is a unique tight contact structure up to isotopy, but if  $\mu$  is even, there are two tight structures which are distinguished by sign.

**Case 7.**  $A = \text{id}$ . This is the 3-torus  $T^3$ . If there is no twisting, then  $s = s_0 = s_1$ .

**Lemma 2.6.**  $(s, \mu, l)$  completely determines the isotopy class of  $\xi$  without twisting in the  $S^1$ -direction.

*Proof.* All the tight structures without  $S^1$ -twisting can be obtained from  $\xi_{\mu,l}$  in Case 5 by using an element of  $SL(2, \mathbb{Z})$  to put the slopes in desired form. If there exists a  $\Sigma'$  isotopic to  $\Sigma$  with slope not equal to  $s$ , then, by passing to  $\widetilde{M} = T^2 \times \mathbb{R}$ , we see that there must be twisting in the  $S^1$ -direction. Hence  $s$  is well-defined. The rest follows from Case 5. q.e.d.

**Case 8.**  $A = -\text{id}$ . Using the previous results, we readily see that the isotopy classes of  $\xi$  without  $S^1$ -twisting are completely determined by the pair  $(s, \mu)$  if  $\mu \in \mathbb{Z}^+$  is odd, and by  $(s, \mu, \pm)$  (choice of  $+$  or  $-$ ) if  $\mu$  is even.

**Case 9.**  $A = T^n$ ,  $n < 0$ . There are two possibilities: Either (1)  $s_1 = s_0 = 0$ , and there is no twisting in the  $S^1$ -direction, in which case the tight structure is uniquely determined by  $(\mu, l)$ , or (2)  $s_1 = -1$ ,  $s_0 = \frac{1}{n-1}$ , and there is minimal twisting. For the latter, there exist  $|n-1|$  possible minimally twisting tight structures on  $T^2 \times [0, 1]$  with  $s_1 = -1$  and  $s_0 = \frac{1}{n-1}$ . They are distinguished by the Euler class, which can take values  $e(\xi, s) = (n + 2k, 0)$ ,  $k = 0, 1, \dots, |n|$ . Let  $\xi_k$  be the tight structure on  $T^2 \times [0, 1]$  with  $e(\xi, s) = (n + 2k, 0)$ . Although  $\xi_k$  is universally tight only when  $k = 0$  or  $|n|$ , the tight structures on  $T^2 \times [0, 1]$  do not become overtwisted when  $T_1$  and  $T_0$  are glued to form  $M$ . In fact,  $\xi$  remains tight even when lifted to  $\widetilde{\xi}$  on  $\widetilde{M} = T^2 \times \mathbb{R}$ , since we are gluing  $T^2 \times I$  with boundary slopes  $s_1 = -1$ ,  $s_0 = \frac{1}{n-1}$ ,  $s_{-1} = \frac{1}{2n-1}$ , and so on, and we can use the Gluing Theorem.

**Lemma 2.7.** *The  $\xi_k$  are not contact isotopic.*

*Proof.* Let  $\Sigma = T_1 \subset M$  be the convex torus in standard form in the splitting of  $M$  above, for which  $\#\Gamma_\Sigma = 2$  and  $s(\Sigma) = -1$ . As before, if we let  $s$  be a nonzero section of  $\xi_k|_\Sigma$  given by the Legendrian rulings, then the relative Euler class  $e(\xi_k, T^2 \times I, s)$  on  $T^2 \times I$  is  $[(n + 2k, 0)] \in H_1(T^2 \times I; \mathbb{Z}) = \mathbb{Z}^2$ . Now, let  $\Sigma' \subset M$  be another convex torus isotopic (but not necessarily contact isotopic) to  $\Sigma$  for which  $\#\Gamma_{\Sigma'} = 2$  and  $s(\Sigma') = -1$ . We prove that the relative Euler class for the cut-open manifold  $M'' = M \setminus \Sigma' \simeq T^2 \times I$  is the same as that of the cut-open manifold  $M' = M \setminus \Sigma$ . We pass to  $(\widetilde{M} = T^2 \times \mathbb{R}, \widetilde{\xi}_k)$  and use a limiting argument. Let  $\Sigma_t, \Sigma'_t$ ,  $t \in \mathbb{Z}$ , be lifts of  $\Sigma$  and  $\Sigma'$ , translated by  $t$  in the  $\mathbb{R}$ -direction from chosen lifts  $\Sigma_0$  and  $\Sigma'_0$ . Let  $N_t$  (resp.  $N'_t$ ),  $t \in \mathbb{Z}^+$ , be the compact region in  $\widetilde{M}$  bounded by  $\Sigma_{-t}$  and  $\Sigma_t$  (resp.  $\Sigma'_{-t}$  and  $\Sigma'_t$ ).

Then define

$$e = \lim_{t \rightarrow \infty} \frac{e(\tilde{\xi}_k, N_t, \tilde{s})}{2t},$$

$$e' = \lim_{t \rightarrow \infty} \frac{e(\tilde{\xi}_k, N'_t, \tilde{s}')}{2t}.$$

If we pass to  $\tilde{M}$ , for large  $t$ , the portion of  $N_t$  and  $N'_t$  which do not overlap is small. Therefore,  $e = e' = [(n + 2k, 0)] \in H_1(T^2 \times \mathbb{R}; \mathbb{Z})$ . This proves that  $\xi_k$  are not contact isotopic. q.e.d.

Note that, of the  $|n - 1|$  tight contact structures, exactly 2 are universally tight.

**Case 10.**  $A = -T^n$ ,  $n < 0$ . Again, there are two possibilities: Either (1)  $s_1 = s_0 = 0$  and there is no twisting, in which case the tight structure is uniquely determined by  $\mu$  if  $\mu$  is odd, and by  $(\mu, \pm)$  if  $\mu$  is even, or (2)  $s_1 = -1$ ,  $s_0 = \frac{1}{n-1}$ , and there is minimal twisting. For the latter, there exist  $|n| + 1$  possible minimally twisting tight structures on  $T^2 \times I$  with  $s_1 = -1$  and  $s_0 = \frac{1}{n-1}$ . However, in this case, we have the following:

**Lemma 2.8.** *The  $|n| + 1$  tight structures on  $T^2 \times I$  all represent the same tight structure on  $M$ .*

*Proof.* This follows from examining  $e(\xi, s)$  on  $T^2 \times [-1, 1]$ . If  $e(\xi, T^2 \times [0, 1], s) = (n + 2k, 0)$ , for some  $k = 0, 1, \dots, |n|$ , then  $e(\xi, T^2 \times [-1, 0], s) = (-n - 2k, 0)$ , due to the sign change arising from the gluing given by  $A = -T^n$ . (In other words, on  $T^2 \times [0, 1]$ ,  $k$  of the basic slices in the decomposition are positive, and, on  $T^2 \times [-1, 0]$ ,  $k$  of the basic slices are negative.) Recall that in [13] we proved the sliding maneuver which allows us to interchange basic slices belonging to the same continued fraction block. Hence we can trade a positive basic slice for a negative one by switching basic slices between  $T^2 \times [0, 1]$  and  $T^2 \times [-1, 0]$ . Hence, in the end, all the basic slices on  $T^2 \times [0, 1]$  can be made positive.

q.e.d.

**2.6. The hyperbolic cases.** The hyperbolic case  $|\text{tr}(A)| > 2$  is the generic situation. Since the non-minimally twisting contact structures are already treated in Section 2.2, we will assume our tight contact structures have minimal twisting.

**Case 11.**  $A = T^{r_0} S T^{r_1} S \dots T^{r_k} S$ , where  $r_0 < -2$ ,  $r_i \leq -2$ . We

will use the representative  $A' = T^{r_0+1}ST^{r_1} \dots T^{r_k}ST^{-1}$  for convenience.

$$A' = \begin{pmatrix} (-r_0 - 1) & 1 \\ -1 & 0 \end{pmatrix} \begin{pmatrix} -r_1 & 1 \\ -1 & 0 \end{pmatrix} \dots \begin{pmatrix} -r_k & 1 \\ -1 & 0 \end{pmatrix} \begin{pmatrix} 1 & -1 \\ 0 & 1 \end{pmatrix}.$$

We claim that, for minimal twisting, there must exist  $\Sigma$  with boundary slope  $s_1 = \infty$ .  $A'$  has an oriented basis  $\{v_1, v_2\}$  of eigenvectors with  $A'v_i = \lambda_i v_i$ ,  $\lambda_1 > 1$ ,  $0 < \lambda_2 < 1$ . Suppose we initially cut along  $\Sigma$  with  $s_1$  corresponding to  $v = av_1 + bv_2$ ,  $b > 0$  (note  $b$  can never equal 0 because the eigenvectors are not rational).  $A' : av_1 + bv_2 \mapsto \lambda_1 av_1 + \lambda_2 bv_2$ . If  $a > 0$ , then the counterclockwise rotation from  $v$  to  $A'v$  crosses both eigenspaces (i.e., the rotation is ‘large’). If  $a < 0$ , then the rotation from  $v$  to  $A'v$  does not cross either eigenspace (‘small’ rotation). In either case, we can find a  $\Sigma$  in  $M$  such that, cutting along  $\Sigma$ , we obtain  $T^2 \times I$  with  $s_1 = \infty$ , by moving in the positive or negative  $\mathbb{R}$ -direction in  $\widetilde{M} = T^2 \times \mathbb{R}$ . Here  $s_1 = \infty$  is just a convenient slope which is located in the counterclockwise sector from slope corresponding to  $v_2$  to slope corresponding to  $v_1$ . Any slope in this sector can be realized by moving ‘forwards’ or ‘backwards’ using  $A^i$ .

Notice that,  $v = (0, 1)^T \mapsto A'v$ , whose slope corresponds to the continued fraction

$$\frac{1}{(r_0 + 1) - \frac{1}{r_1 \dots \frac{1}{r_k + 1}}}.$$

Denote this by  $\langle r_0 + 1, r_1, \dots, r_k + 1 \rangle$ . Upon iteration by  $A'$ , we successively get

$$\langle r_0 + 1, r_1, \dots, r_k, r_0, r_1, \dots, r_k + 1 \rangle,$$

$$\langle r_0 + 1, r_1, \dots, r_k, r_0, r_1, \dots, r_k, r_0, \dots, r_k + 1 \rangle,$$

and so on. Therefore, by using the Gluing Theorem, any tight structure on  $T^2 \times [0, 1]$  with boundary slopes  $s_1 = \infty$  and  $s_0$  corresponding to  $\leq r_0 + 1, r_1, \dots, r_k + 1 >$  will remain tight when passing to the cover  $\widetilde{M} = T^2 \times \mathbb{R}$  — it survives covering in the  $S^1$ -direction!

The number of tight contact structures with minimal twisting on such a  $T^2 \times I$  is  $|(r_0 + 1)(r_1 + 1) \dots (r_k + 1)|$ .

**Lemma 2.9.** *The  $|(r_0 + 1)(r_1 + 1) \dots (r_k + 1)|$  tight structures are all distinct.*

*Proof.* We will use an argument which is part contact-topological and part homotopy-theoretic, along the lines of Lemma 2.7. Suppose

there exists another convex torus  $\Sigma' \subset M$  isotopic to the fiber  $T^2$ , with  $\#\Gamma_{\Sigma'} = 2$  and slope  $= \infty$ . Cut  $M$  along  $\Sigma'$  to obtain  $M'' \simeq T^2 \times [0, 1]$ . We use the fact that the tight contact structure on  $M$  lifts to a tight contact structure  $\tilde{\xi}$  on  $\tilde{M} = T^2 \times \mathbb{R}$ , and  $(\tilde{M}, \tilde{\xi})$  is factored *uniquely* into continued fraction blocks. (This is seen easily by taking exhaustions of  $\tilde{M}$  by  $T^2 \times [-C, C]$  as  $C \rightarrow \infty$ .) If  $M' = T^2 \times [0, 1]$  is  $M$  cut along  $\Sigma$ , then  $M'$  is a union of continued fraction blocks. Since the slopes of the boundary of  $M'$  and  $M''$  are the same, by the unique factorization,  $M'$  and  $M''$  must be isotopic inside  $\tilde{M}$ . This proves that all the tight structures which are distinct on  $T^2 \times [0, 1]$  are distinct on  $M$ . q.e.d.

**Remark.** It is also true that the tight structures remain distinct under diffeomorphisms. Use the fact that the only incompressible tori on  $M$  are isotopic to a fiber  $T^2$ . We then see that the fibers must be preserved, and we can use the argument in the previous claim.

**Case 12.**  $A = -T^{r_0} S T^{r_1} S \cdots T^{r_k} S$ . This is essentially the same as Case 11, since all the computations in Case 11 are based on *slope*, which cannot distinguish the action by  $A$  and the action by  $-A$ . The only difference is that, whereas in Case 11, two of the contact structures are universally tight, here none of the contact structures are universally tight.

### Part 2. Tight contact structures on circle bundles which fiber over closed oriented surfaces

In the second part of the paper we give a complete classification of tight contact structures on circle bundles over closed Riemann surfaces. Consider an oriented circle bundle  $\pi : M \rightarrow \Sigma$  over a closed oriented surface  $\Sigma$  with genus  $g(\Sigma) = g$ . The most basic invariant of tight contact structures on circle bundles is the *twisting number*  $t(S^1)$ , which is the maximum twisting number  $\leq 0$  among all the closed Legendrian curves  $\gamma$  isotopic to the  $S^1$ -fiber, relative to the framing induced from the fibration. Note that if there exists a Legendrian curve  $\gamma$  isotopic to  $S^1$  with  $t(\gamma) > 0$  we simply *define*  $t(S^1)$  to be zero. Recall that an ‘isotopy’ means an isotopy in the  $C^\infty$ -category, as opposed to a ‘contact isotopy’, which is an isotopy preserving contact structures.

Let us first recall the classification of tight contact structures on circle bundles over  $\Sigma = S^2$ . If  $g(\Sigma) = 0$  we have a lens space, treated in [13, 10].

**Theorem 2.10.** *Let  $M \rightarrow S^2$  be a circle bundle with Euler number  $e$ .*

1. *If  $e > 1$ , then  $M = L(e, e - 1)$ , and there is one tight contact structure.*
2. *If  $e = 1, -1$ , then  $M = S^3$ , and there is one tight contact structure.*
3. *If  $e = 0$ , then  $M = S^1 \times S^2$ , and there is one tight contact structure.*
4. *If  $e < -1$ , then  $M = L(|e|, 1)$ , and there are  $|e| - 1$  tight contact structures.*
5. *All the tight contact structures are holomorphically fillable.*

If  $\Sigma = T^2$ , then circle bundles over  $T^2$  are torus bundles over  $S^1$ . These were already treated in Part 1 — see the table there (Parabolic type, first three rows).

From now on we will assume  $g > 1$ . Let us briefly summarize the classification result (some of the terminology will be defined later):

**Theorem 2.11.** *Let  $M \rightarrow \Sigma$  be a circle bundle with Euler number  $e$  over a closed Riemann surface  $\Sigma$  of genus  $g > 1$ . Then, the tight contact structures on  $M$  are as follows (classified up to contact isotopy):*

1. *If  $2g - 2 \geq e > 0$ ,  $e|2g - 2$ , then for each  $n \in \mathbb{Z}^+$  satisfying  $en = 2g - 2$ , there exist  $\mathbb{Z}^{2g}$  distinct tight structures with  $t(S^1) = -n$ , distinguished by the holonomy  $k : \{\gamma_1, \dots, \gamma_{2g}\} \rightarrow \mathbb{Z}$ . These are all horizontal, i.e., can be made transverse to the  $S^1$ -fibers.*
2. *If  $2g - 2 > e$ , there are  $(2g - 1) - e$  tight structures with  $t(S^1) = -1$ , only two of which are universally tight and horizontal.*
3. *The universally tight structures with  $t(S^1) = 0$  are, up to isotopy, in 1-1 correspondence with the set  $\mathcal{D}$  of all possible dividing sets  $\Gamma$  on  $\Sigma$ , all of whose connected components are homotopically nontrivial.*
4. *All tight contact structures on  $M$  with  $t(S^1) = 0$  are universally tight, with the exception of 1 tight contact structure for  $e = 2g$ , and 2 tight contact structures for  $e > 2g$ .*

The universally tight classification was previously obtained by Giroux. He also recently obtained an almost complete classification, independently from the author (see [11]). Our classification is complete — our most difficult case is Part 4 of Theorem 2.11. In order to prove that the tightness of these virtually overtwisted contact structures, we use the *state traversal* technique, introduced in Part 1. We conjecture that these virtually overtwisted contact structures are not symplectically semi-fillable.

### 3. Classification for $t(S^1) < 0$

In Part 2, *Legendrian curves* are assumed to be closed curves. Legendrian curves with boundary will be *Legendrian arcs*. Also, a *vertical Legendrian curve*  $\gamma$ , without reference to its twisting number, will be understood to have  $t(\gamma) = 0$  relative to the fibration.

The following is an edge-rounding lemma which will be used frequently in this paper.

**Lemma 3.1** (Edge-Rounding). *Let  $\Sigma_1$  and  $\Sigma_2$  be compact convex surfaces with collared Legendrian boundary in a contact manifold  $(M, \xi)$ . (This means there exist convex annuli  $A_i = \gamma_i \times I$ ,  $i = 1, 2$  which are in standard form and so that  $\gamma_i \times \{1\}$  is a boundary component of  $\Sigma_i$ .) Assume  $A_1$  and  $A_2$  intersect transversely along  $\gamma_1 \times \{1\} = \gamma_2 \times \{1\}$ . The neighborhood of the common boundary Legendrian is locally isomorphic to the neighborhood  $\{x^2 + y^2 \leq \varepsilon\}$  of  $M = \mathbf{R}^2 \times (\mathbf{R}/\mathbf{Z})$  with coordinates  $(x, y, z)$  and contact 1-form  $\alpha = \sin(2\pi nz)dx + \cos(2\pi nz)dy$ , for some  $n \in \mathbf{Z}^+$ . After possible perturbation (rel boundary), we may take  $A_1 = \{x = 0, 0 \leq y \leq \varepsilon\}$  and  $A_2 = \{y = 0, 0 \leq x \leq \varepsilon\}$ . If we join  $\Sigma_1$  and  $\Sigma_2$  along  $x = y = 0$  and round the common edge, the resulting surface is convex, and the dividing curve  $z = \frac{k}{2n}$  on  $\Sigma_1$  will connect to the dividing curve  $z = \frac{k}{2n} - \frac{1}{4n}$  on  $\Sigma_2$ , where  $k = 0, \dots, 2n - 1$ .*

Let  $\gamma$  be a Legendrian curve isotopic to  $S^1$ , with  $t(\gamma) = t(S^1) = -n < 0$ . After isotopy, we may take  $\gamma = \pi^{-1}(p)$ ,  $p \in \Sigma$ , and  $\pi^{-1}(q)$  for all  $q$  near  $p$  to be Legendrian with twisting  $-n$  — to see this, look at the standard convex neighborhood  $N(\gamma)$  of  $\gamma$ , which admits an  $S^1$ -fibration by Legendrian curves with twisting number  $-n$  parallel to  $\gamma$ . Consider closed curves  $\gamma_1, \dots, \gamma_{2g}$  in  $\Sigma$  which (1) begin and end at  $p$ , (2) are mutually nonintersecting away from  $p$ , (3) generate  $\pi_1(\Sigma)$ , and (4) are smooth everywhere except for a corner at  $p$ . Let  $T_i = \pi^{-1}(\gamma_i)$ . If

we perform edge-rounding (using the Edge-Rounding Lemma) on  $T_i$  by rounding  $\gamma_i$ , and call the modified tori  $T_i$  as well, we obtain a standard annular region  $A_i = T_i \cap N(\gamma)$  with  $2n$  horizontal dividing curves. Here  $N(\gamma)$  is a tubular neighborhood of  $\gamma$ . We now perturb  $T_i$  while fixing  $A_i$  to make  $T_i$  convex. If there exist bypasses, this would contradict the maximality of  $t(S^1)$ ; hence we may assume there are no bypasses, and  $T_i$  is a standard convex torus with vertical Legendrian rulings and non-vertical dividing curves.

For each  $T^2$  which is identified as a circle bundle  $S^1 \times \delta$ , where  $\delta$  is an oriented smooth curve in the base, and where the dividing curves are not vertical, we can define the *holonomy*  $k(\delta)$  which is the holonomy of a dividing curve, measured in terms of one-half the number of upward jumps taken by a lift of  $\delta$  to a dividing curve, as seen on  $\mathbb{R} \times \delta$ . Notice that the notion of holonomy is far from canonical — the holonomy depends crucially on the identification of the  $T^2$  as a circle bundle.

We now cut  $\Sigma$  along the  $\gamma_i$  to obtain a polygonal representation  $P$ , and pull the bundle back to  $P$  to obtain the solid torus  $S^1 \times P$ .

**Lemma 3.2.** *The holonomy around  $S^1 \times P$ , after rounding the edges, is  $-(2g - 1) + en$ .*

*Proof.* This is essentially the Gauß-Bonnet Theorem. Identify

$$N(\gamma) \simeq (\mathbb{R}/\mathbb{Z}) \times U$$

with coordinates  $(z, x, y)$ , where  $U \subset \Sigma$  is a small disk around  $p$ . We may assume that the contact structure  $\xi$  is given by the 1-form  $\alpha = \sin(2\pi n z)dx + \cos(2\pi n z)dy$ . Let  $\delta_1$  and  $\delta_2$  be oriented arcs on  $\Sigma$  that meet at  $p$  at an angle  $0 \leq \beta < \pi$  from  $\delta_1$  to  $\delta_2$  and the orientations point inward towards  $p$ . When we round the edge of  $S^1 \times (\delta_2 - \delta_1)$ , the Legendrian divides will ‘drop’ by  $\frac{\pi - \beta}{2\pi n}$ . Notice that  $\pi - \beta$  is the *outer angle*. Now, when computing the holonomy around  $P$ , the holonomy contribution of  $\gamma_i$  will be canceled by that of  $-\gamma_i$ ; hence the only contributions that remain are the sums of the outer angles and the bundle contribution. The outer angles add up to give  $-(2g - 1)$ , and  $en$  is the bundle contribution. q.e.d.

We will refer to the *slope* of a nontrivial closed curve on  $\partial(S^1 \times P)$  by making an oriented identification with  $\mathbb{R}^2/\mathbb{Z}^2$  as follows. First orient the  $S^1$ -fibers. We then let the longitude be given by the oriented  $S^1$ -direction. The meridian will correspond to  $(1, 0)^T$  and the longitude to  $(0, 1)^T$ . We will follow this convention throughout, and let the  $S^1$ -fibers correspond to  $(0, 1)^T$  in similar identifications with  $\mathbb{R}^2/\mathbb{Z}^2$ .



By Lemma 3.2, the slope on the solid torus is  $\frac{-(2g-1)+en}{n}$ . If this term is positive,  $t(S^1)$  could not have been  $< 0$ , and if it is zero,  $\xi$  is overtwisted. Therefore,  $-(2g-1) + en < 0$ , implying  $e < 2g - 1$ .

We have two possibilities:  $-(2g-1) + en = -1$  or  $-(2g-1) + en < -1$ . In the former case,  $en = 2g - 2$ , and  $e|2g - 2$ . In the latter case, set  $a = -(2g-1) + en < -1$ . Assume  $n > 1$ . There are two cases. (1) If  $a$  and  $n$  are not relatively prime, then the solid torus  $S^1 \times P$  with boundary slope  $\frac{a}{n}$  has more than two dividing curves, and on the interior, there is a solid torus with convex boundary and the same boundary slope but  $\#\Gamma_{\partial(S^1 \times D^2)} = 2$ . (2) If  $(a, n) = 1$ , then on the interior of  $S^1 \times P$  there is a solid torus with  $\#\Gamma_{\partial(S^1 \times D^2)} = 2$  and boundary slope  $-\frac{1}{m}$  with  $0 < m < n$ . In either case, we see that there exists a Legendrian curve isotopic to  $S^1$  with larger twisting number. Hence we may assume  $n = 1$ .

**3.1. Case 1:  $e|2g - 2$ ,  $2g - 2 \geq e > 0$ .** Let  $\gamma_1, \dots, \gamma_{2g}$  be smooth oriented curves generating  $\pi_1(\Sigma)$  such that the  $T_i = \pi^{-1}(\gamma_i)$  are convex tori in standard form with vertical Legendrian rulings of twisting number  $-n$ .

**Lemma 3.3.** *There exist tight contact structures with twisting number  $-n$ , where  $en = 2g - 2$ .*

*Proof.* The contact structure  $\xi$  is easily constructed: first define it on the neighborhood of the tori  $T_i$  and extend it to the solid torus  $S^1 \times P$  in the unique way which makes the contact structure tight on  $S^1 \times P$ . Here  $P$  is the polygonal representation of  $\Sigma$ . To prove the (universal) tightness of  $\xi$ , we will use an idea which first appeared in Kanda's paper [14], and 'pass to some finite cover of the base'. Namely, we tile together enough copies of  $P$  to form  $P'$  so that  $S^1 \times P'$  contains a copy of the candidate overtwisted disk  $D$ . Each  $S^1 \times P$  is, after edge-rounding, a standard neighborhood of a Legendrian curve with twisting  $-n$ , and the union of two copies of  $S^1 \times P$ , after rounding, is still isomorphic to a standard neighborhood of a Legendrian curve with twisting number  $-n$ . Hence,  $S^1 \times P'$ , after rounding, is the standard neighborhood of a Legendrian curve with twisting number  $-n$  — such a contact manifold is clearly tight. This contradicts the existence of  $D$  and proves the universal tightness.

We now claim that  $\xi$  satisfies  $t(S^1) = -n$ . Assume there exists a  $\gamma$  with  $t(\gamma) > -n$ . Again pass to  $P'$  so that  $S^1 \times P'$  contains  $\gamma$ . Since  $S^1 \times P'$  is the standard neighborhood of a Legendrian curve with

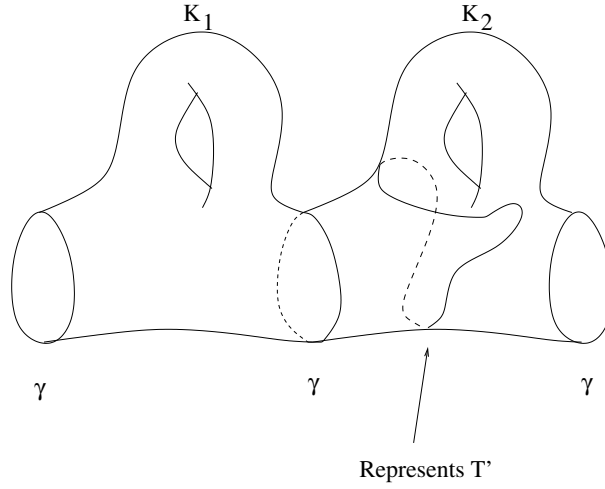

Figure 2: Passing to a finite cover

twisting number  $-n$ , there cannot exist a Legendrian curve isotopic to  $S^1$  with twisting number  $> -n$ . q.e.d.

Next, given a tight contact structure  $\xi$ , we can define its *holonomy function*  $k_\xi : \{\gamma_1, \dots, \gamma_{2g}\} \rightarrow \mathbb{Z}$  as follows: Cut  $M$  along  $T_1$  and identify  $M \setminus T_1 \simeq S^1 \times (\Sigma \setminus \gamma_1)$ . Fixing this trivialization of the  $S^1$ -bundle we can talk about the holonomy along  $\gamma_i$ ,  $i = 2, \dots, 2g$ . Let the holonomy along  $\gamma_1$  be the holonomy of  $\gamma_1^+$ , where  $\partial(\Sigma \setminus \gamma_1) = \gamma_1^+ - \gamma_1^-$ . Note that Lemma 3.3 constructs tight contact structures with  $t(S^1) = -n$  and any holonomy.

**Lemma 3.4.**  $k_\xi$  is well-defined.

*Proof.* Omit subscripts for  $T$  and  $\gamma$ , so  $T = T_i$  and  $\gamma = \gamma_i$  are fixed (for the same  $i$ ). Let  $T'$  be another convex torus in standard form, isotopic to  $T$ , with vertical Legendrian rulings of twisting number  $-n$ . Assume  $T'$  has holonomy which is different from  $T$ . We exploit the fact that  $\xi$  is universally tight, and will ‘pass to some cover’ again. See Figure 2 for an illustration. Let  $K = \Sigma \setminus \gamma$ , so that  $\partial K = \gamma^+ - \gamma^-$ , where  $\gamma^\pm$  are copies of  $\gamma$ . Take  $m$  copies  $K_1, \dots, K_m$  of  $K$ , as well as copies  $\gamma^{k,\pm}$ ,  $k = 1, \dots, m$ , of  $\gamma^\pm$ , (not to be confused with the  $\gamma_i$ ), and glue  $\gamma^{1,-}$  with  $\gamma^{2,+}$ ,  $\gamma^{2,-}$  with  $\gamma^{3,+}$ , ...,  $\gamma^{m-1,-}$  with  $\gamma^{m,+}$ , to obtain  $K'$ , which is an  $m$ -fold cover of  $\Sigma$  cut along a copy of  $\gamma$ . Pull the  $S^1$ -bundle back to  $K'$  to obtain  $S^1 \times K'$ . Assume we have chosen  $m$  large enough so that there exists an embedded copy  $i(T')$  of  $T'$  inside

$S^1 \times K'$  and  $S^1 \times K' = M_1 \cup M_2$ , split by  $i(T')$ . Let  $i(T)$  denote the embedded copy of  $T$  inside  $S^1 \times K'$ , isotopic to  $i(K')$ . If the holonomy of  $i(T')$  is not the same as that of  $i(T)$ , then if we cut open  $M_i$  to obtain  $S^1 \times P_i$ ,  $i = 1, 2$ , for polygons  $P_i$ , one of the  $S^1 \times P_i$  will have holonomy around the boundary  $\geq 0$ . This contradicts the fact that  $t(S^1) = -n$  is preserved under taking covers (argued as in Lemma 3.3).    q.e.d.

Lemma 3.4 essentially says that the holonomy only depends on the isotopy class of the oriented curve in the base. Also note that  $k_\xi$  uniquely determines the tight contact structure up to isotopy, since fixing convex surfaces  $T_i$  forces the cut-open manifold  $S^1 \times P$  to have convex boundary, boundary slope  $-\frac{1}{n}$ , and  $\#\Gamma_{\partial(S^1 \times P)} = 2$ , which implies that  $S^1 \times P$  must necessarily be the standard neighborhood of a Legendrian curve with twisting number  $-n$ .

**3.2. Case 2:  $n = 1$ ,  $2g - 2 > e$ .**    If  $n = 1$  and  $2g - 2 > e$ , then the slope on the solid torus  $S^1 \times P$  is  $s = -(2g - 1) + e < -1$ . By the classification of tight contact structures on solid tori, there exist exactly  $|s|$  tight contact structures on the solid torus  $S^1 \times P$ . These are all holomorphically fillable, by comparing with a construction of Gompf [12] (Corollary 5.7). Consider the Legendrian knot diagram consisting of  $g$  copies of Figure 3 summed together. This Legendrian knot  $K$  has  $tb(K) = 2g - 1$  and  $r(K) = 0$ , and we may perform  $(2g - 2)$ -surgery. By adding zigzags we can take  $tb(K') = (2g - 1) - (|s| - 1)$ , and there are  $|s|$  choices for the rotation number  $|r(K')| \leq 2g - 2 - e = |s| - 1$ .

First we observe the following:

**Lemma 3.5.**    *The tight contact structures on  $M$  for this case all remain tight when pulled back to  $S^1 \times \tilde{\Sigma}$ , where  $\tilde{\Sigma} = \mathbb{R}^2$  is the universal cover of  $\Sigma$ .*

*Proof.* If there is an overtwisted disk in  $S^1 \times \tilde{\Sigma}$ , then it sits in a part of the cover obtained by gluing only *finitely* many copies of  $S^1 \times P$  together. We prove that, given tight contact structures on two solid tori  $S^1 \times P_1$  and  $S^1 \times P_2$  with minimal convex boundary in standard form, negative integer boundary slopes  $s_1$  and  $s_2$ , and vertical Legendrian rulings, if we glue the contact structures along a vertical ruling curve (or more precisely a thickened annular neighborhood  $A$  in standard form of a vertical ruling curve), then the contact structure on their union is tight, the boundary is minimal, convex, and in standard form, and the boundary slope is  $s_1 + s_2 + 1$ . Start with horizontal ruling curves on  $S^1 \times P_2$ , and take a meridional disk  $D$  with Legendrian boundary. If

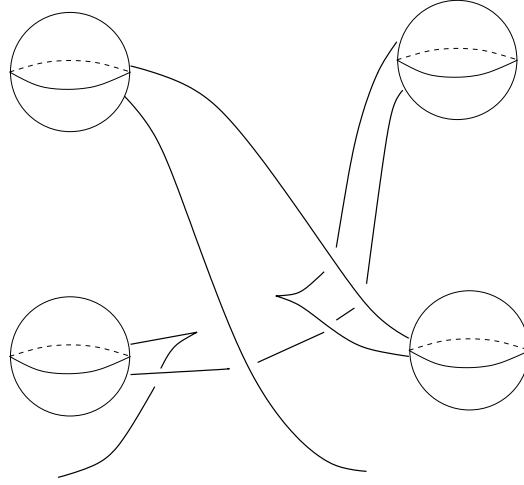

Figure 3: Legendrian link diagram

there are no bypasses along  $D$ , then  $s_2 = -1$  and the gluing is no problem. If there is a bypass, then we may assume that the endpoints of the bypass are attached to the dividing curves of  $\partial(S^1 \times P_2)$ . We may ‘slide the bypass’ so that the slope of the bypass is  $\gg 0$  as seen on  $\partial(S^1 \times P_2)$ , and the endpoints of the bypass lie on dividing curves of  $A$ . (See the Appendix for a discussion of bypass sliding.) Modify the characteristic foliation on  $A$  slightly so that the endpoints of the bypass lie on a Legendrian arc on  $A$ . The key observation here is that the characteristic foliation can be modified without affecting the bypass. This is possible because the endpoints of the bypass lie on dividing curves, and the characteristic foliation modifications can be performed *away from* the dividing set. We now remove the bypass from  $S^1 \times P_2$  and attach it to  $S^1 \times P_1$ , thickening  $S^1 \times P_1$  to have slope  $s_1 - 1$  and thinning  $S^1 \times P_2$  to have slope  $s_2 + 1$ . The attachment of the bypass preserves tightness (since it is easy to find explicit models), and the tightness of the contact structure on the union follows from repeated application of the peeling and reattaching process. q.e.d.

Lemma 3.5 gives an alternate proof of the tightness of  $\xi$ . In addition, it implies the following:

**Lemma 3.6.**  $t(S^1) = -1$  in this case.

*Proof.* The proof is similar to Lemma 3.3. If there exists a Legendrian curve  $\gamma$  isotopic to  $S^1$  with  $t(\gamma) = 0$ , then we pass to some cover

of the base, by tiling finitely many copies of the polygon  $P$  to obtain  $P'$ , so that  $\gamma \subset S^1 \times P'$ . This solid torus has large negative slope. Inside a solid torus with negative slope there cannot exist a solid torus with slope  $\infty$  (= a standard neighborhood  $\gamma$ ) by the classification of tight contact structures on  $S^1 \times D^2$ . q.e.d.

**Lemma 3.7.** *There exists a unique tight contact structure on  $M$  for each tight contact structure on  $S^1 \times P$ .*

*Proof.* Unlike Case 1, the holonomy is not an isotopy invariant. This is because we can attach a bypass to any  $T_i$  and modify its holonomy by  $\pm 1$ , the sign depending on which side the bypass is attached. (If you switch the side the bypass is attached to, then you reverse signs.) The bypass comes from a bypass along the meridional disk, translated along a dividing curve (c.f. Appendix), so that the bypass becomes almost vertical as in Lemma 3.5. q.e.d.

The  $|s|$  tight contact structures on  $M$  in this case are distinct up to contact isotopy. This follows from observing that they correspond to distinct homotopy classes of 2-plane fields. The Poincaré dual to  $c_1(\xi)$  is computed to be  $r(K)S^1$ , where  $r(K)$  is the rotation number in Gompf's surgery construction and  $S^1$  is the  $S^1$ -fiber.

**3.3. Classification of horizontal contact structures on circle bundles.** In this section we classify contact structures on circle bundles which are *horizontal*, i.e., can be made transverse to the  $S^1$ -fibers after diffeomorphism. These are necessarily universally tight and weakly symplectically fillable by Lemma 3.9 below. One may think of the following classification theorem as a contact-quantized version of the classical Milnor-Wood inequality for foliations ([15], [17]). The contact version of the Milnor-Wood inequality first appeared in [16] and an earlier version of [11].

**Theorem 3.8.** *Let  $M \rightarrow \Sigma$  be a circle bundle over a closed Riemann surface  $\Sigma$  with Euler number  $e$ . Then, the horizontal contact structures are as follows (classified up to contact isotopy):*

1. *If  $g = 1$ ,  $e = 0$ , then there are  $\mathbb{Z}^+ \times \mathbb{Z}^2$  horizontal contact structures. They are distinguished by  $t(S^1) \in \mathbb{Z}^+$ , together with the holonomy  $k : \{\gamma_1, \gamma_2\} \rightarrow \mathbb{Z}$ .*
2. *If  $g > 1$ ,  $2g - 2 \geq e > 0$ ,  $e|2g - 2$ , then for each  $n \in \mathbb{Z}^+$  satisfying  $en = 2g - 2$ , there exist  $\mathbb{Z}^{2g}$  distinct horizontal con-*

*tact structures with  $t(S^1) = -n$ , distinguished by the holonomy  $k : \{\gamma_1, \dots, \gamma_{2g}\} \rightarrow \mathbb{Z}$ .*

3. *If  $g \geq 1$ ,  $2g - 2 > e$ , there exist two horizontal contact structures with  $t(S^1) = -1$ .*

*Proof.* We will prove that the horizontal contact structures satisfy  $t(S^1) < 0$ . Assume otherwise, i.e., there exists  $\gamma$  with  $t(\gamma) = 0$ . Then we ‘pass to some cover of the base’ as follows: Consider  $\gamma_1, \dots, \gamma_{2g}$  as before, and cut  $\Sigma$  along the  $\gamma_i$  to obtain the standard polygonal representation  $P$  of  $\Sigma$ . Paste together enough copies of  $P$  so that this union contains  $\gamma$ . As before, consider  $S^1 \times P$ , which we assume has convex boundary. (We assume  $T_i$  have already been made convex after isotopy). However, note that the holonomy around each  $S^1 \times \partial P$  is negative, and holonomy is additive, so the solid torus containing  $\gamma$  must have negative holonomy. This contradicts the existence of a zero twisting Legendrian by the classification of solid tori.

Now we apply the classification of tight structures with  $t(S^1) < 0$ . For (3), there are only two tight structures in the correct homotopy class if  $g > 1$ ,  $2g - 2 > e$ , and  $t(S^1) = -1$ . We are left with proving that all the tight structures in (2) and (3) can be made transverse to the  $S^1$ -fibers. For this we need to change the convex tori that we cut along from standard form to nonsingular Morse-Smale form. If there is only one torus  $\Sigma_1$  in standard form, we may use the Legendrian realization principle and make it Morse-Smale. If there are two convex tori  $\Sigma_1$  and  $\Sigma_2$  in standard form which meet along a common Legendrian ruling curve, we need to perturb with care so that both  $\Sigma_1$  and  $\Sigma_2$  become Morse-Smale and their intersection is a transverse curve. We sketch how to make the modification and leave the verification to the reader. Take the 3-torus  $T^3 = \mathbb{R}^3/\mathbb{Z}^3$  with coordinates  $(x, y, z)$  and tight contact structure  $\xi_n$ ,  $n \in \mathbb{Z}^+$ , given by  $\alpha_n = \sin(2\pi nz)dx + \cos(2\pi nz)dy$  for some  $n \in \mathbb{Z}^+$ . We take a contact embedding  $\Sigma_1 \cup \Sigma_2 \hookrightarrow T^3$  so that  $\Sigma_1 = \{y = 0\}$  and  $\Sigma_2 = \{x = 0\}$ . They intersect along  $L = \{x = y = 0\}$ . Modify  $\Sigma_1$  to  $\Sigma'_1 = \{y = h(z) = \varepsilon \sin(2\pi nz)\}$ , where  $\varepsilon$  a small positive number. Similarly, let  $\Sigma'_2 = \{x = g(z) = -\varepsilon \cos(2\pi nz)\}$ . The characteristic foliations will be Morse-Smale, and the two surfaces will intersect transversely. We also leave to the reader that the interior of  $S^1 \times P$  can be extended to a horizontal contact structure by examining the holonomy on the boundary.    q.e.d.

**Lemma 3.9.** *Let  $\xi$  be a contact structure which is everywhere transverse to the fibers of a circle bundle  $M$  over a closed oriented surface  $\Sigma$  with  $g(\Sigma) \geq 1$ . Then  $\xi$  is (weakly) symplectically fillable and universally tight.*

*Proof.* Let  $X^4$  be the corresponding disk bundle over  $\Sigma$  with fiber  $D^2$  and projection  $\pi$  onto  $\Sigma$ . Then there exists a symplectic form  $\Omega$  obtained by taking  $\pi^*(A)$ , where  $A$  is an area form on  $\Sigma$ , and adding a 2-form  $\omega$  which would be  $\pi_1^*(B)$  if  $X^4 = D^2 \times \Sigma$ ,  $\pi_1^*$  was the first projection (onto  $D^2$ ), and  $B$  was an area form on  $D^2$ . (If not a product, it needs to be glued appropriately, using a symplectic connection.) It is easy to see that  $\Omega|_\xi = \pi^*(A)|_\xi > 0$  and  $\xi$  is weakly symplectically fillable. Take an arbitrarily large finite cover  $\widetilde{M} \rightarrow M$ , expanded both in the fiber direction and in the  $\Sigma$  direction.  $\widetilde{M}$  is a circle bundle over a closed oriented surface, and the lift  $\widetilde{\xi}$  of  $\xi$  would still be transverse to the circle fibers. By the same argument  $\widetilde{\xi}$  is tight, and hence  $\xi$  is universally tight (since any overtwisted disk in the universal cover must still be an overtwisted disk when pushed down to some large finite cover). q.e.d.

#### 4. Classification for $t(S^1) = 0$

Let  $\gamma$  be the Legendrian curve with  $t(\gamma) = 0$ , which we assume has already been isotoped into a fiber. We will decompose  $\Sigma$  into a union of pairs-of-pants  $\Sigma_i$ ,  $i = 1, \dots, k$  (three-holed spheres), and correspondingly decompose  $M$  into a union of  $S^1 \times \Sigma_i$ . The decomposition will be performed so that the slopes of the dividing curves on the boundary are all vertical. In the next section, we will classify tight contact structures with vertical boundary slopes over pairs-of-pants. Subsequently, we glue together the boundaries of the pairs-of-pants and determine whether the tight contact structures remain tight. It turns out that in every instance for  $e < 2g$  and every instance except for one for  $e = 2g$  and two for  $e > 2g$ , the tight contact structure on  $\Sigma$  is universally tight, and is  $S^1$ -invariant.

If  $\alpha$  and  $\beta$  are isotopy classes of (not necessarily connected) curves on a compact surface  $F$ , then denote their minimal geometric intersection number by  $|\alpha \cap \beta|$ . If  $a \in \alpha$  and  $b \in \beta$ , then define  $|a \cap b| = |\alpha \cap \beta|$ .

**4.1. Pair-of-pants.** In this section we classify tight contact structures on  $S^1 \times \Sigma_0$ , where  $\Sigma_0$  is a pair-of-pants, and all the boundary components are convex with vertical dividing curves. Let  $\partial(S^1 \times \Sigma_0) =$

$T_1 + T_2 + T_3$ . Assume  $T_i$  are in standard form, with horizontal Legendrian rulings. Then consider a surface isotopic to  $\Sigma_0$ , with Legendrian boundary components which are Legendrian ruling curves on each of  $T_1, T_2, T_3$ . Perturb this surface so that it is convex and call it  $\Sigma_0$ . Assume also that  $\Sigma_0$  is  $\#\Gamma$ -minimizing, i.e.,  $\#\Gamma_{\Sigma_0}$  is minimal among surfaces of the same isotopy type and Legendrian boundary. (This definition is not to be confused with that of a *minimal* convex torus, which means  $\#\Gamma = 2$ .) Write  $\partial\Sigma_0 = \gamma_1 + \gamma_2 + \gamma_3$ , where  $\gamma_i = T_i \cap \Sigma_0$ .

By the *configuration* of dividing curves on a convex  $F$ , we mean the isotopy type of  $\Gamma_F$ .

**Lemma 4.1.** *For tight contact structures on  $S^1 \times \Sigma_0$ , all of whose boundary components  $T_i$ ,  $i = 1, 2, 3$ , are convex with slope  $\infty$ ,  $\Gamma_{\Sigma_0}$  determines the tight contact structure on  $S^1 \times \Sigma_0$ , provided  $\Sigma_0$  is  $\#\Gamma$ -minimizing. Moreover, the tight contact structures are  $S^1$ -invariant.*

*Proof.* In this lemma we do not assume that  $\#\Gamma_{T_i} = 2$ . If  $\#\Gamma_{T_i} > 2$  and there exists a  $\partial$ -parallel component of  $\Sigma_0$  along  $\gamma_i$ , then take the corresponding bypass and peel off a  $T^2 \times I$  layer using the bypass half-disk. According to the dividing number reduction procedure in [13], the  $T^2 \times I$  layer that is peeled off is  $S^1$ -invariant and is completely determined by the configuration of dividing curves on a  $\#\Gamma$ -minimizing horizontal annulus with Legendrian boundary. We repeat this procedure to each  $T_i$  until either (1) there are no more  $\partial$ -parallel components along  $\gamma_i$ , and the new  $T_i$  is still convex with vertical dividing curves, or (2)  $T_i$  is minimal, has vertical dividing curves, and has a  $\partial$ -parallel component along  $\gamma_i$  (hence a degenerate bypass).

Assume first that (1) holds for each  $T_i$ . Then each arc  $\delta$  of  $\Gamma_{\Sigma_0}$  is one of two types —  $\delta$  is *nonseparating* and connects  $\gamma_i$  to another  $\gamma_j$ , or  $\delta$  is *separating* and connects between the same  $\gamma_i$ , but is not  $\partial$ -parallel. In the separating case, there is a unique non- $\partial$ -parallel isotopy class of arcs with endpoints on  $\gamma_i$ . See Figure 4 for two possible configurations of  $\Gamma_{\Sigma_0}$ . All the arcs except for a vertical arc in Figure 4(B) are nonseparating. Figure 4(B) also indicates that there may be spiraling around some  $\gamma_i$ . We can now cut  $S^1 \times \Sigma_0$  along  $\Sigma_0$  to obtain a genus 2 handlebody. Use the Edge-Rounding Lemma to round the edges so that the boundary of the handlebody is smooth and convex.

We claim the tight contact structure on this genus 2 handlebody  $H = \Sigma_0 \times I$  is unique. In order to decompose  $H$  into  $B^3$  by cutting along meridional disks, we first use the Legendrian realization principle to modify the characteristic foliation on  $\partial H$  so that the meridional disks



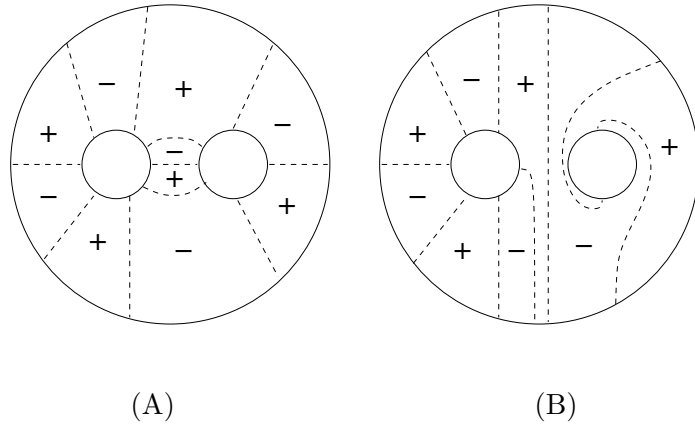

Figure 4: Possible configurations of dividing curves. Dotted lines represent dividing curves

have Legendrian boundary. If  $\delta$  is a nonseparating arc on  $\Sigma_0$ , then take the corresponding meridional disk  $\delta \times I \subset \Sigma_0 \times I$ .  $|\partial(\delta \times I) \cap \Gamma_{\partial H}| = 2$ , and we have a meridional disk whose boundary intersects  $\Gamma_{\partial H}$  in only two points. There are at least two nonparallel nonseparating arcs on  $\Sigma_0$ , and hence two corresponding meridional disks — enough to decompose into a 3-ball. There is only one possible dividing curve configuration for a convex disk with Legendrian boundary whose  $tb = -1$ . Therefore, there is only one possible tight structure on  $S^1 \times \Sigma_0$  with the given configuration of dividing curves on  $\Sigma_0$  — this follows from the uniqueness of the tight contact structure on the 3-ball with fixed boundary characteristic foliation. On the other hand, there is indeed an  $S^1$ -invariant tight structure (see Lemma 4.2 below) with the given configuration of  $\Sigma_0$  (one without homotopically trivial dividing curves). The tight contact structure is therefore determined by  $\Sigma_0$  and is  $S^1$ -invariant in this case.

Assume at least one  $T_i$ , say  $T_1$ , satisfies (2). Cut  $S^1 \times \Sigma_0$  along  $\Sigma_0$  to obtain a genus 2 handlebody  $H$ . Write  $\partial H = \Sigma_0^+ \cup \Sigma_0^- \cup (I \times \partial \Sigma_0)$ , where  $\Sigma_0^\pm$  are the two copies of  $\Sigma_0$ . If there were  $k$  closed dividing curves  $\delta_1, \dots, \delta_k$  parallel to  $\gamma_1$  on  $\Sigma_0$  ( $\delta_i$  is closer to  $\gamma_1$  than  $\delta_{i+1}$ ), then on  $\partial H$ , after rounding, there are  $2k + 1$  closed dividing curves parallel to  $\gamma_1^+ \subset \Sigma_0^+ \subset \partial H$ .  $2k$  of them are  $\delta_i^\pm$ ,  $i = 1, \dots, k$ , and the last one  $\delta$  is derived from the  $\partial$ -parallel component on  $\Sigma_0$  along  $\gamma_1$ . Take a convex meridional disk  $D$  (after Legendrian realization) for  $H$  which nontrivially intersects the  $2k + 1$  parallel dividing curves (but without

any superfluous intersections). Recall a bypass along a convex surface has its corresponding Legendrian arc of attachment, which intersects exactly three dividing curves. The fact that  $\Sigma_0$  is  $\#\Gamma$ -minimizing implies that, for any bypass on  $D$ , the three dividing curves intersecting the arc of attachment cannot all intersect  $\Sigma_0^+$  and cannot all intersect  $\Sigma_0^-$ . This implies that a dividing curve on  $D$  with one endpoint between  $\delta_i^+$  and  $\delta_{i+1}^+$  must have the other endpoint between  $\delta_i^-$  and  $\delta_{i+1}^-$ . (Also the curve with one endpoint between  $\delta$  and  $\delta_1^+$  has other endpoint between  $\delta$  and  $\delta_1^-$ .) This proves that there is only possible configuration for  $D$ , and proves the uniqueness of the tight contact structure with  $\#\Gamma$ -minimizing  $\Sigma_0$ . q.e.d.

**4.2.  $S^1$ -invariant tight contact structures on  $S^1$  times a surface.** In this section we completely classify  $S^1$ -invariant tight contact structures on  $S^1 \times F$ , where  $F$  is an oriented compact surface and  $\partial(S^1 \times F)$  is convex.

**Lemma 4.2** (Giroux). *An  $S^1$ -invariant contact structure on  $S^1 \times F$ , where  $F$  is a closed convex surface  $\neq S^2$  or a compact convex surface with Legendrian boundary, is universally tight if and only if  $F$  has no dividing curves which bound a disk.*

*Sketch of proof.* This follows from Colin's theorem [1] on gluing universally tight contact structures along pre-Lagrangian surfaces which may be  $T^2$  or annuli with Legendrian boundary. A more thorough proof can be found in [1]. Colin's proof relies in an essential way on the cutting surfaces being pre-Lagrangian, which provides the necessary invariance under dilation. Let  $D$  be a potential overtwisted disk. The invariance allows us to push  $D$  across the pre-Lagrangian surface (contact isotop it to one side of the pre-Lagrangian) to obtain a contradiction. Since it is a bit difficult to perform directly on  $T^2$  or  $S^1 \times I$ , we pass to the universal cover  $\pi : \mathbb{R} \times \tilde{F} \rightarrow S^1 \times F$ , where  $\tilde{F} \rightarrow F$  is the universal cover of  $F$ . The dividing curves on  $\tilde{F}$  correspond to pre-Lagrangian surfaces in  $\mathbb{R} \times \tilde{F}$  with vertical characteristic foliations.  $D$  can be pushed into  $\mathbb{R} \times \tilde{F}_s$ , where  $\tilde{F}_s$  is a connected component of  $\tilde{F} \setminus \Gamma_{\tilde{F}}$ . If  $\tilde{F}_s$  is a half-disk,  $\mathbb{R} \times I$ , or  $I \times I$ , then the contact structure can be embedded inside  $(\mathbb{R}^3, \xi_0)$ , where  $\xi_0$  is the standard tight structure. If not,  $\tilde{F}_s$  deformation retracts onto a tree, represented by the network  $N$  of singular points (all of the same sign), together with their connecting trajectories. Since  $\mathbb{R} \times N$  is a union of (covers of) pre-Lagrangian surfaces, we can push  $D$  into one of the connected components of  $\mathbb{R} \times (\tilde{F}_s \setminus N)$ , which can be

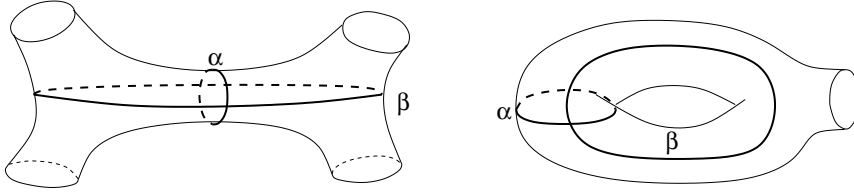

Figure 5: Pants decomposition

embedded in  $(\mathbb{R}^3, \xi_0)$ , and obtain a contradiction. q.e.d.

We also need to prove the uniqueness of the  $\#\Gamma$ -minimizing configuration on  $F$  up to isotopy. But first we prove a preliminary lemma, whose proof is courtesy of Will Kazez.

**Lemma 4.3.** *Let  $F$  be a closed oriented surface of genus  $> 1$ , and  $\Gamma, \Gamma' \hookrightarrow F$  be multicurves (= finite disjoint union of embedded closed curves) without homotopically trivial components. If  $|\gamma \cap \Gamma| \leq |\gamma \cap \Gamma'|$  for every simple closed curve  $\gamma \subset F$ , then  $\Gamma \hookrightarrow \Gamma'$ ; in other words,  $\Gamma$  can be isotoped into a subset of  $\Gamma'$ .*

*Proof of Lemma.* (Due to W. Kazez) Define  $\Gamma_{red} = \Gamma / \sim$ , where all parallel curves of  $\Gamma$  are squashed into one copy of the curve. Similarly define  $\Gamma'_{red}$ . Assume all the curves in this paragraph are represented by geodesics. If  $\alpha \in \Gamma'_{red}$ , then  $|\alpha \cap \Gamma_{red}| = 0$ , and either  $\alpha \in \Gamma_{red}$  or  $\alpha$  is disjoint from  $\Gamma_{red}$ . If we take  $F \setminus \Gamma'_{red}$ , then each component  $F_0$  is a punctured Riemann surface with *negative* Euler characteristic. If there exists a non-boundary parallel curve  $\alpha$  in  $F_0$ , then there is a closed curve  $\beta$  with  $|\alpha \cap \beta| \neq 0$ . In fact, we can further decompose  $F \setminus \Gamma'_{red}$  into pairs-of-pants with copies  $\alpha^+, \alpha^-$  of  $\alpha$  which are boundary components of a single pair-of-pants or two pairs-of-pants. If we take the single pair-of-pants or the two pairs-of-pants and glue  $\alpha^+$  to  $\alpha^-$ , we have the two possibilities depicted in Figure 5. In either situation there is a  $\beta$  with  $|\alpha \cap \beta| \neq 0$ . This proves  $\Gamma_{red} \hookrightarrow \Gamma'_{red}$ .

Next we need to take care of the multiplicities of the curves. However, the multiplicities are also controlled, since for every  $\alpha \in \Gamma'_{red}$  there exists a ‘dual’ curve  $\beta$  as above. Hence  $\Gamma \hookrightarrow \Gamma'$ . q.e.d.

**Proposition 4.4.** *Consider the  $S^1$ -invariant tight structure on  $S^1 \times F$ , where a convex  $F$  is closed or is compact with Legendrian boundary, and all the boundary tori have vertical dividing curves and*

*horizontal Legendrian rulings. Then  $F$  is uniquely  $\#\Gamma$ -minimizing in the following sense: Given another convex  $F'$  isotopic to  $F$ , we have  $\Gamma_F \subset \Gamma_{F'}$ . (For  $F$  with Legendrian boundary, we assume  $F'$  is isotopic to  $F$  rel boundary).*

*Proof.* If there exist  $F$  and  $F'$  with distinct configurations (we may assume they are identical on  $\partial F$ ), then pass to  $\mathbb{R} \times F \rightarrow S^1 \times F$  and find copies of  $F$  and  $F'$  (still called  $F$  and  $F'$ ) so that they are disjoint and moreover  $F'$  sits ‘above’  $F$ , i.e., if  $t$  is the coordinate for  $\mathbb{R}$ , then we get from  $F$  to  $F'$  by flowing in the  $\frac{\partial}{\partial t}$ -direction. This is possible since the  $S^1$ -invariant tight structure is universally tight. Also assume that  $F$  and  $F'$  are oriented by  $\frac{\partial}{\partial t}$ . Let  $\gamma$  be a curve on  $F$  which is either closed or has endpoints on  $\partial F$ , and  $\gamma'$  a parallel copy on  $F'$ . We may represent  $\gamma$  as a Legendrian curve on  $F$  with possible endpoints at the singular points of  $\partial F$  which has minimal geometric intersection  $|\gamma \cap \Gamma_F|$ . Also represent  $\gamma'$  as a Legendrian on  $F'$  with intersection  $|\gamma' \cap \Gamma_{F'}|$ . If  $|\gamma \cap \Gamma_F| > |\gamma' \cap \Gamma_{F'}|$ , then take the annulus between  $\gamma$  and  $\gamma'$  if  $\gamma$  is closed. If  $\gamma, \gamma'$  are (properly embedded) Legendrian arcs with endpoints  $p_1, p_2$  which are singular points of  $\partial F$ , then we need to make the following slight modification (and still call these arcs  $\gamma, \gamma'$  after this rounding operation): each  $p_i, i = 1, 2$ , is contained in a connected component of  $\partial F \setminus \Gamma_F$  with endpoints  $q_i$  and  $r_i$ . Assume  $[p_i, q_i] \subset \partial F$  is the subarc for which the flow from  $q_i$  to  $p_i$  agrees with the orientation on  $\partial F$  induced from  $F$ . Then we take  $\gamma \cup [p_1, q_1] \cup [p_2, q_2]$  instead. ( $\gamma'$  modified similarly.)

By the Imbalance Principle (c.f. [13]) there exists a bypass half-disk  $D$  on  $F$ . Let  $\delta \subset \gamma \subset F$  be the Legendrian arc of attachment for  $D$  with  $\delta \cap \Gamma_F$  consisting of  $a_1, a_2, a_3$  in order along  $\delta$ , and  $\partial\delta = a_1 - a_3$ . Let  $\Sigma_1$  be the component of  $F \setminus \Gamma_F$  containing the arc  $[a_1, a_2] \subset \delta$  and  $\Sigma_2$  be the component containing  $[a_2, a_3]$ . The possible boundary components of  $\Sigma_i, i = 1, 2$ , are closed dividing curves or closed curves which consist of arcs of  $\Gamma_F$  and arcs of  $\partial F$ . The one situation we want to rule out first is when there exists a half-disk region  $D_0 \subset \Sigma_i$  (say  $i = 1$ ) where  $\partial D_0 = [a_1, a_2] \cup \beta$  and  $\beta$  is a subarc of  $\Gamma_F$ . Assume first  $a_3 \notin \beta$ . Then attachment of the bypass gives a homotopically trivial closed dividing curve if  $D_0$  is to one side of  $\delta$ ; assume therefore that  $D_0$  is on the other side of  $\delta$ . If  $a_1$  is not an endpoint of  $\gamma$ , then  $\gamma$  does not have minimal geometric intersection with  $\Gamma_F$ . On the other hand,  $a_1$  cannot be an endpoint of  $\gamma$ , since the rounding operation above should force  $\gamma$  away from  $a_1$ , not toward it. Next assume  $a_3 \in \beta$ . Since  $\gamma$  enters  $D_0$  along

$a_3$ , it must exit  $D_0$  in another point  $a_4$ , contradicting the minimality of  $|\gamma \cap \Gamma_F|$ . Thus, there cannot exist half-disk regions  $D_0$  as above.

We may now use the argument in Lemma 4.2. Pass to the universal cover  $\tilde{F}$  of  $F$ . Let  $\tilde{D}$  be some lift of  $D$  with  $\tilde{D} \cap \tilde{F} = \tilde{\delta}$ , and let  $\tilde{\Sigma}_i$ ,  $i = 1, 2$ , be the universal cover of (a lift of)  $\Sigma_i$  in  $\tilde{F}$ . Having ruled out half-disk components, we now know that each side of  $\tilde{\Sigma}_i$  cut by  $\tilde{\delta}$  is either semi-infinite or has boundary components which consist of alternating  $\partial F$  arcs and  $\Gamma_{\tilde{F}}$  arcs. Using Colin's argument, we may  $\tilde{D}$  in a small neighborhood of  $\mathbb{R} \times (\tilde{\Sigma}_1 \cup \tilde{\Sigma}_2)$ . Now let  $N_i$  be the network of singular points of  $\tilde{\Sigma}_i$ , say, which is a tree. Let  $\gamma_j$ ,  $j = 1, 2, 3$ , be dividing curves on  $\tilde{F}$  which pass through the lift of  $a_j$  on  $\tilde{\delta}$ . Then let  $\tilde{\Sigma}'_i \subset \tilde{\Sigma}_i$  be the union of connected components of  $\tilde{\Sigma}_i \setminus N_i$  (recall we take the metric closure of the complements) which border  $\gamma_i$  and  $\gamma_{i+1}$ . As before, we may retract  $\tilde{D}$  inside  $\mathbb{R} \times (\tilde{\Sigma}'_1 \cup \tilde{\Sigma}'_2)$ . Therefore, we find that  $\tilde{D}$  can be placed inside (a small neighborhood of) the tight contact manifold  $(\mathbb{R} \times [-1, 1] \times [0, 1], \xi)$ , given by coordinates  $(t, x, y)$  and 1-form  $\alpha = \sin(2\pi y)dt + \cos(2\pi y)dx$ . Here,  $\tilde{\delta}$  will be mapped to  $\{x = t = 0\}$ . Now, a bypass increases the twisting number of a Legendrian curve, but we know that  $\{x = t = 0\}$  has maximal twisting number in its isotopy class rel boundary. (This follows from an argument along the lines of Kanda [14].) This contradiction proves that  $|\gamma \cap \Gamma_F| \leq |\gamma \cap \Gamma_{F'}|$  for any Legendrian arc (as above) or Legendrian closed curve  $\gamma$ .

Lemma 4.3 then finishes the proof when  $F$  is closed. (The cases when  $F = S^2$  or  $T^2$  are straightforward, and left to the reader.) When  $F$  has Legendrian boundary, choose the curves  $\gamma$  to be Legendrian arcs which intersect  $\Gamma_{F'}$  only at the endpoints of  $\gamma$ . If we apply  $|\gamma \cap \Gamma_F| \leq |\gamma \cap \Gamma_{F'}|$  to the set of all such  $\gamma$ 's, then the arcs of  $\Gamma_F$  become completely determined. The closed curves are treated in the same way as the case when  $F$  is closed by finding dual curves.   q.e.d.

**4.3. Decomposing and reconstructing.** Let  $\xi$  be a tight contact structure on the circle bundle  $M$  over the base  $\Sigma$  with a vertical Legendrian curve. Then there exist tori isotopic to  $S^1 \times \gamma$ , where  $\gamma$  is a closed curve on  $\Sigma$ , with vertical dividing curves. Let  $T$  be  $\#\Gamma$ -minimizing amongst convex tori in its isotopy class with slope  $\infty$ , and consider  $M' = M \setminus T = S^1 \times \Sigma'$ , where  $\Sigma' = \Sigma \setminus \gamma$ . We now decompose  $M'$  into circle bundles over pairs-of-pants, subject to the requirement that each convex torus  $T_i$  that  $M'$  is cut along must contain a vertical Legendrian and hence have slope  $\infty$ . If there are no nearby vertical Legendrians, we must isotop  $T_i$  so that it is close to a vertical Legendrian

$L$  and picks up a (vertical Legendrian) copy of  $L$ . Lemma 4.1 and Proposition 4.4 guarantee that for each pair-of-pants  $\Sigma_i$ ,  $S^1 \times \Sigma_i$  will have a unique  $S^1$ -invariant tight structure encoded by the configuration of dividing curves on  $\Sigma_i$ . We glue back and obtain an  $S^1$ -invariant tight structure on  $M'$ , determined by the  $\#\Gamma$ -minimizing set of dividing curves on  $\Sigma'$ .

We now know that for  $\xi|_{M'}$  to be tight,  $\Sigma'$  must not have any dividing curves bounding disks. Let  $\partial M' = T^+ - T^-$ . Gluing  $M'$  along  $T^\pm$  to recover  $M$  requires some effort and we will show that there is one stubborn configuration. If there are no  $\partial$ -parallel components of  $\Sigma'$  attached along  $T^\pm$ , then we can glue copies of  $M'$  to obtain a  $\mathbb{Z}$ -cover  $\widetilde{M}$  of  $M$  which is universally tight, since no disks bounded by dividing curves appear. If there are  $\partial$ -parallel components of  $\Sigma'$  along  $T^\pm$ , then  $\#\Gamma_{T^\pm} = 2$ , since  $T$  is  $\#\Gamma$ -minimizing. Indeed, if  $\#\Gamma_T > 2$ , a bypass attachment would reduce  $\#\Gamma_T$  by 2. If there is a  $\partial$ -parallel component only on one of the  $T^\pm$ , then we can pass to  $\widetilde{M}$ . If there are  $\partial$ -parallel components on both sides, and the signs are opposite, the gluing preserves tightness as well. When gluing two copies  $M'_1$  and  $M'_2$  of  $M'$  along  $T_1^+$  and  $T_2^-$ , we must arrange the sections  $s_1, s_2 : \Sigma' \rightarrow S^1 \times \Sigma'$  to differ by the Euler number of the circle bundle, if we want a section of  $M'_1 \cup M'_2$ . To ‘shift’ the sections, we repeatedly apply the following Section Change Lemma. The proof is left to the reader.

**Lemma 4.5** (Section Change). *Let  $\Sigma_0$  be a pair-of-pants, and let  $(S^1 \times \Sigma_0, \xi)$  be an  $S^1$ -invariant tight contact manifold with convex boundary, all of whose boundary slopes are  $\infty$ . By Proposition 4.4,  $\xi$  is uniquely determined by the  $\#\Gamma$ -minimizing convex surface  $\Sigma_0$ . Given  $a, b, c \in \mathbb{Z}$  with  $a + b + c = 0$ , there exists a section  $\sigma : \Sigma_0 \rightarrow S^1 \times \Sigma_0$  which is convex,  $\#\Gamma$ -minimizing, has slopes  $a, b, c$  on  $T_1, T_2, T_3$ , and whose dividing set, when projected down to  $\Sigma_0$  via  $\pi : S^1 \times \Sigma_0 \rightarrow \Sigma_0$ , is isotopic to  $\Gamma_{\{pt\} \times \Sigma_0}$ . Hence we may view the tight structure as an  $S^1$ -invariant tight structure on  $S^1 \times \sigma(\Sigma_0)$ .*

The difficult case is when the signs of the  $\partial$ -parallel components are the same (in other words, the contact structure has an overtwisted cover). If  $\Sigma'$  has any dividing curves besides the two  $\partial$ -parallel components, then there exist vertical Legendrian curves on  $S^1 \times \Sigma'$  besides the Legendrian curves corresponding to  $S^1 \times \{p\}$ , where  $p$  is any point on  $\partial$ -parallel components. By ‘borrowing’ this Legendrian curve, we obtain disjoint  $T^2 \times I$  layers  $N_1, N_2 \subset S^1 \times \Sigma'$ , where  $N_1 \cap \partial(S^1 \times \Sigma') = T^+$  and  $N_2 \cap \partial(S^1 \times \Sigma') = T^-$ . Both  $N_1$  and  $N_2$  have convex boundary,

boundary slope  $\infty$ , and  $\pi$  twisting. If we glue  $N_1$  and  $N_2$  along  $T^\pm$  and identify the torus fiber with  $\mathbb{R}^2/\mathbb{Z}^2$  so that the (oriented) vertical fibers correspond to  $(0,1)$ , then  $e(\xi, N_1, s) = e(\xi, N_2, s) = (0,2)$  (or both  $(2,0)$ ), which gives an overtwisted contact structure. Hence we may assume that the two  $\partial$ -parallel components are the only dividing curves on  $\Sigma'$ .

Next we rule out  $e < 2g$ . We first peel off disjoint  $T^2 \times I$  layers  $N_1, N_2 \subset S^1 \times \Sigma'$  with  $N_1 \cap \partial(S^1 \times \Sigma') = T^+$  and  $N_2 \cap \partial(S^1 \times \Sigma') = T^-$  using the bypasses corresponding to the  $\partial$ -parallel components on  $\Sigma'$ . This means that  $N_1, N_2$  both have one boundary component which is minimal convex with slope 0, and  $\frac{\pi}{2}$  twisting. Write  $M'' = M' \setminus (N_1 \cup N_2)$ . The boundary slopes of  $M''$  are zero, and  $M''$  has no vertical Legendrian. Now, successively cut  $M''$  along  $S^1 \times \gamma$ , where  $\gamma$  is an arc in the base, to obtain  $S^1 \times P$  as in Section 3. The slope of  $S^1 \times P$ , after rounding is  $1 - 2g$ . This implies the existence of a bypass along a meridional disk. We perform bypass sliding as in Section 3 to make these almost vertical, and peel off a  $T^2 \times I$  layer  $N'_1 \subset M''$ , which shares a common boundary component with  $M''$  and has boundary slopes 0 and  $2 - 2g$ . As long as  $e \leq 2g - 1$ ,  $N_1 \cup N_2 \cup N'_1$  is overtwisted. Therefore, what we have left is a universally tight contact structure on  $S^1 \times \Sigma'$ , which is glued to give a contact structure on  $M$  with  $e \geq 2g$ , such that  $\Gamma_{\Sigma'}$  projected down to  $\Sigma$  consists of one homotopically trivial curve. The study of such virtually overtwisted structures with  $t(S^1) = 0$  requires more care, and will be deferred to the next section.

To finish our classification for  $t(S^1) = 0$ , note that the configuration  $\Gamma_{\tilde{\Sigma}}$ , where  $\tilde{\Sigma}$  is the  $\mathbb{Z}$ -cover of  $\Sigma$  corresponding to gluing copies of  $\Sigma'$ , can be pushed down to a configuration  $\Gamma_\Sigma$  on  $\Sigma$  without homotopically trivial curves. Proposition 4.4 proves the uniqueness of the  $\#\Gamma$ -minimizing configuration on  $\Sigma'$ , but the projection onto  $\Sigma$  still depends on the cutting torus  $T$  which gave rise to  $M' = M \setminus T = S^1 \times \Sigma'$ . In order to simplify things a bit, we require that the cutting torus  $T$  be  $\#\Gamma$ -minimizing amongst isotopic convex tori with vertical slope. We now prove the following, which finishes the proof.

**Proposition 4.6** (Unique Projection). *Given a universally tight contact structure on  $M$  with  $t(S^1) = 0$ , we can uniquely associate a dividing set  $\Gamma$  on  $\Sigma$ . Two tight contact structures which are assigned distinct  $\Gamma$ 's are distinct.*

*Proof.* We show that the projection  $\pi(\Gamma_{\Sigma'})$  does not depend on the cutting torus. Consider two cutting tori  $T, T'$  with vertical slopes

which are convex and  $\#\Gamma$ -minimizing amongst isotopic convex tori with vertical slopes.

First consider the case where  $T, T'$  are disjoint. If  $T, T'$  are isotopic, hence cobound a  $T^2 \times I$ , then the independence follows from Proposition 4.4, together with the  $S^1$ -invariance of the tight contact structures on  $T^2 \times I$  and  $M \setminus (T^2 \times I)$ . Otherwise, we reduce to the case where  $T, T'$  are two boundary components of some  $S^1 \times \Sigma_0$  (here  $\Sigma_0$  is a pair-of-pants), and all three boundary components of  $S^1 \times \Sigma_0$  have vertical slopes. Then we may pass between the  $\#\Gamma$ -minimizing convex sections for  $M \setminus T$  and  $M \setminus T'$  without changing the projection down to  $\Sigma$ , by using the Section Change Lemma and Proposition 4.4.

Next assume  $T = T_0, T'$  are isotopic but not necessarily disjoint. We may assume  $T_0 \pitchfork T'$ . Then  $T_0 \cap T'$  on  $T'$  will consist of homotopically trivial curves as well as parallel essential curves. Take an ‘innermost’ homotopically trivial curve  $\delta$  on  $T'$ . If  $\delta$  bounds disks  $D' \subset T'$  and  $D \subset T_0$ , then surger to obtain  $T_1 = (T_0 \setminus D) \cup D'$ . If there are no homotopically trivial curves, then take a pair of consecutive parallel curves  $\delta_1, \delta_2$  on  $T'$ . If  $A' \subset T'$  and  $A \subset T_0$  with  $\partial A = \partial A' = \delta_1 - \delta_2$ , then surger  $T_1 = (T_0 \setminus A) \cup A'$ . After perturbation,  $T_1$  is convex, has vertical dividing curves (since all the convex surfaces isotopic to  $T_0$  must have vertical slope),  $T_1 \cap T_0 = \emptyset$ , and  $\#(T_1 \cap T') < \#(T_0 \cap T')$ . We can apply the Section Change Lemma from the previous paragraph to  $T_0, T_1$ , and now work with  $T_1, T'$ . By induction we are done with this case.

The general situation follows from the previous two cases.    q.e.d.

## 5. Virtually overtwisted structures with $t(S^1) = 0$

Let us now give a slightly different description of the (candidate) virtually overtwisted contact structures, which follows without too much difficulty from the previous definition. There exist two contact structures for each  $e > 2g$  (depending on the sign of the bypasses) and one for  $e = 2g$ , and they are obtained as follows: Start with any horizontal contact structure on the  $S^1$ -bundle over  $\Sigma$  with Euler number  $2g - 2$ . Remove a neighborhood  $N(\gamma)$  of a Legendrian curve  $\gamma$  with  $t(\gamma) = -1$ , so that from the point of view of  $-\partial(M \setminus N(\gamma))$ , the dividing curves on the boundary have slope  $-(2g - 1)$ . Here we are viewing  $-\partial(M \setminus N(\gamma)) = \mathbb{R}^2/\mathbb{Z}^2$  with coordinates  $(x, y)$  and the  $y$ -direction given by the  $S^1$ -fiber and the  $x$ -direction given by a section of the  $S^1$ -



bundle on  $M \setminus N(\gamma)$ . Now glue in a solid torus  $S^1 \times D^2$  with boundary slope  $e - (2g - 1)$ , via the map  $\phi : -\partial(M \setminus N(\gamma)) \rightarrow \partial(S^1 \times D^2)$  given by  $\begin{pmatrix} 1 & 0 \\ e & 1 \end{pmatrix}$  which maps  $(1, -(2g - 1))^T \mapsto (1, e - (2g - 1))^T$  and  $(-1, e)^T \mapsto (-1, 0)^T$ . Notice that there exist two tight contact structures on  $S^1 \times D^2$  with boundary slope  $e - (2g - 1)$  up to contact isotopy, if  $e > 2g$ , and one if  $e = 2g$ . Part of our difficulty is due to the fact that these contact structures are overtwisted when passing to any double cover of the base  $\Sigma$ , which makes it impossible to use the tiling approach used in Section 3.

**5.1. Pair-of-pants, part II.** In this section we extend the results of Section 4.1 and classify tight contact structures on  $S^1 \times \Sigma_0$ , where  $\Sigma_0$  is a pair-of-pants, and we impose more general boundary conditions. Let us use the same notation as Section 4.1.

**Lemma 5.1.** *Let  $\Sigma_0$  be a pair-of-pants, and  $\partial(S^1 \times \Sigma_0) = T_1 + T_2 + T_3$ . The tight contact structures on  $S^1 \times \Sigma_0$  with minimal convex boundary, and boundary slopes  $a, b, c \in \mathbb{Z}$ , respectively for  $T_1, T_2, T_3$ , are classified as follows:*

1. *A tight contact structure with a vertical Legendrian curve admits a factorization  $S^1 \times \Sigma_0 = L_1 \cup L_2 \cup L_3 \cup (S^1 \times \Sigma'_0)$ , where  $L_i$  are disjoint toric annuli with minimal twisting and minimal boundary,  $\partial L_i = T_i - T'_i$ , and all the components of  $\partial(S^1 \times \Sigma'_0) = T'_1 + T'_2 + T'_3$  have slope  $\infty$ .*
2. *A universally tight contact structure with a vertical Legendrian curve admits a unique extension to  $S^1 \times \Sigma''_0$ , obtained by adding toric annuli  $L''_i$  with minimal twisting and minimal boundary, so that all the components of  $\partial(S^1 \times \Sigma''_0) = T''_1 + T''_2 + T''_3$  have slope  $\infty$ . There is a 1-1 correspondence between universally tight contact structures on  $S^1 \times \Sigma_0$  with vertical Legendrians and  $\#\Gamma$ -minimizing configurations of dividing curves on  $\Sigma''_0$ .*
3.  $a + b + c \geq 2$ .
  - (a) *There always exists a vertical Legendrian curve.*
  - (b) *Universally tight contact structures — satisfy (2) above.*
  - (c) *Virtually overtwisted contact structures —  $\exists 1$  if  $a + b + c = 3$ ,  $2$  if  $a + b + c > 3$ , and none if  $a + b + c = 2$ .*

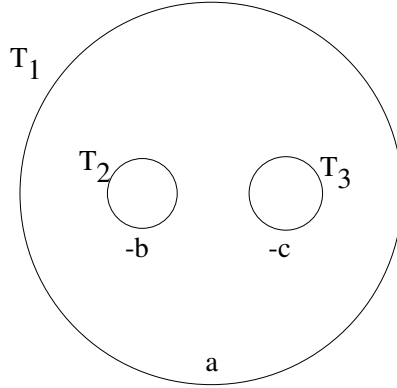
Figure 6: Representing  $S^1 \times \Sigma_0$ 

4.  $a + b + c < 2$ .

- (a) *Tight structures with a vertical Legendrian curve — necessarily universally tight, and satisfy (2) above.*
- (b) *Tight structures with no vertical Legendrian curve —  $\exists 2 - (a + b + c)$  tight structures.*

We pictorially represent the tight structure on  $S^1 \times \Sigma_0$  by drawing  $\Sigma_0$  and labeling the slopes of the  $T_i$  as in Figure 6. Note that the outer circle corresponds to  $T_1$  and the two inner circles are  $T_2$  and  $T_3$ , and we are labeling them with slopes of  $-T_2$  and  $-T_3$ .

*Proof.* Let  $a + b + c \geq 2$ . We first prove that there always exists a vertical Legendrian curve. To see this, make the Legendrian rulings on  $T_2$  and  $T_3$  vertical and take a vertical annulus  $A$  between  $T_2$  and  $T_3$  with Legendrian boundary. If there exists a (degenerate) bypass on  $A$ , then we immediately have a vertical Legendrian curve. Therefore assume the dividing curves on  $A$  are parallel and there are no bypasses. Let  $N$  be a small neighborhood of  $T_2 \cup T_3 \cup A$ . If  $\partial N = T_2 + T_3 + T$ , then  $T$  has slope  $-b - c + 1$ , after edge-rounding. Since  $a + b + c \geq 2$ , we have  $a > -b - c + 1$ . On the toric annulus  $(S^1 \times \Sigma_0) \setminus N$  with boundary slopes  $a, -b - c + 1$  (as seen from  $T_1$ ) there must exist a vertical Legendrian by Proposition 1.2. When we say “ $T^2 \times [0, 1]$  has slopes  $p, q$ ”, we mean  $p$  is the slope for  $T^2 \times \{1\}$  and  $q$  is the slope for  $T^2 \times \{0\}$ .

Once we have one vertical Legendrian, we may find  $T'_i$  parallel to  $T_i$  which have slope  $\infty$ , by incorporating copies of the vertical Legendrian into  $T'_i$ . By rechoosing  $T'_i$  if necessary, we may assume (i)  $T'_i$  has minimal

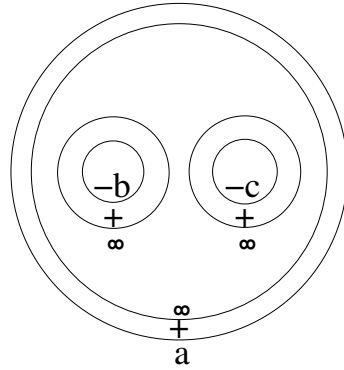

Figure 7: Factoring

boundary, and (ii) the layer  $L_i$  with  $\partial L_i = T_i - T'_i$  is a basic slice. (i) follows from the fact that if a  $(T^2 \times [0, 3], \xi)$  has nonzero  $\beta_I$ , then there exists a factorization  $T^2 \times [0, 3] = \cup_{i=0}^2 (T^2 \times [i, i + 1])$ , where  $T^2 \times [0, 1]$  and  $T^2 \times [2, 3]$  are nonrotative ( $\beta_I = 0$ ) and  $T^2 \times [1, 2]$  has minimal boundary. (See [13] for details.) Therefore, we have basic slices  $L_1, L_2, L_3$  with slopes  $a, \infty; b, \infty; c, \infty$ , and an inner core  $(S^1 \times \Sigma_0) \setminus (L_1 \cup L_2 \cup L_3) = S^1 \times \Sigma'_0$ . See Figure 7.

There are two possibilities for each basic slice  $L_i$ . Recall the discussion of relative Euler class in Section 1.1.3. Since the  $S^1$  fibers are already oriented, we let  $v_0$  in that discussion be  $(0, 1)$ . Once this identification is made, each  $L_i$  may be *positive* or *negative*. The signs in Figure 7 are possible signs of the  $L_i$ . The tight contact structures on  $S^1 \times \Sigma'_0$  are  $S^1$ -invariant and are classified, according to Lemma 4.1, by  $\Gamma_{\Sigma'_0}$  for a  $\#\Gamma$ -minimizing convex  $\Sigma'_0$  with Legendrian boundary.

Consider first the situation where there are no bypasses on  $\Sigma'_0$ , i.e., the dividing curves are as in Figure 8 and each dividing arc connects  $T'_i$  to a different  $T'_j$ . Assume the signs of  $L_i$  are mixed, i.e., without attention to order we have  $+, +, -$  or  $+, -, -$ . We prove the contact structure on  $S^1 \times \Sigma_0$  is universally tight by showing that there exists a unique extension of  $S^1 \times \Sigma_0$  to  $S^1 \times \Sigma''_0 = L''_1 \cup L''_2 \cup L''_3 \cup (S^1 \times \Sigma_0)$ , where basic slices  $L''_i$  with slopes  $\infty, a$  (or  $\infty, b$ , or  $\infty, c$ ) are attached along  $T_i$ . For each basic slice  $L''_i$  there are two choices of sign; however, the signs of  $L_i$  and  $L''_i$  must be the same for the contact structure with  $\beta_I = \pi$  on  $L_i \cup L''_i$  to be tight. The tight contact structure on  $L_i \cup L''_i$  has  $\beta_I = \pi$ , and has boundary slopes  $\infty, \infty$  — by the classification (Theorem 1.1), it must also be universally tight and  $S^1$ -invariant, once the boundary is

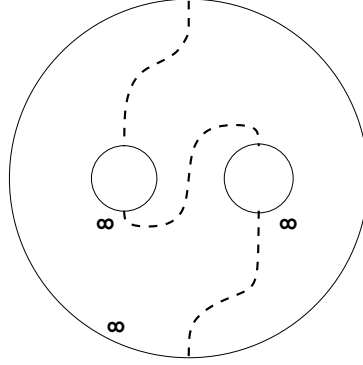

Figure 8: Minimal configuration. The dividing curves are dotted lines.

given horizontal Legendrian rulings. The  $S^1$ -invariant contact structure on  $S^1 \times \Sigma_0''$  will have no homotopically trivial dividing curves on  $\Sigma_0''$ , hence  $S^1 \times \Sigma_0''$  is universally tight.

Assume the signs are not mixed, i.e.,  $+, +, +$  or  $-, -, -$ . By taking a suitable diffeomorphism of  $S^1 \times \Sigma_0$ , we normalize  $b = c = 1$ . This amounts to a section change. We first show that the contact structure is tight, provided  $a + b + c > 2$ . The following is a tight model for this contact structure: start with a solid torus with boundary slope  $a > 0$ , and remove two standard neighborhoods of Legendrian curves parallel to the  $S^1$ -fiber with twisting number  $-1$ . There are two possible Legendrian curves with twisting number  $-1$  up to Legendrian isotopy, given by the two possible zigzags that can be added to the twisting number  $0$  curve in the solid torus — we choose the type which gives a virtually overtwisted contact structure on  $T^2 \times I$  when it is removed from  $S^1 \times D^2$ . We leave it to the reader to verify that this model indeed represents  $+, +, +$  or  $-, -, -$ .

If  $a + b + c = 2$ , then we claim the contact structures are overtwisted (the same argument works for  $a + b + c \leq 2$  so we assume this instead). Since  $b = c = 1$ ,  $a \leq 0$ , and we factor a  $T^2 \times I$  layer  $\subset L_3$  with slopes  $a, 1$ . Then  $S^1 \times \Sigma_0$  is of the type discussed above. Note that in the tight model above, we may let the vertical annulus  $A$  from  $T_2$  to  $T_3$  have parallel horizontal dividing curves. Take  $N = N(T_2 \cup T_3 \cup A)$  with  $\partial N = T_2 + T_3 + T$ , so that  $T$  has boundary slope  $-1$  (as seen from  $T_1$ ). This means that the layer  $L = (S^1 \times \Sigma_0) \setminus N$  has slopes  $a, -1$ . By the tight model, we know that this admits a factorization into two basic slices with slopes  $a, \infty$  and  $\infty, -1$  with opposite signs. If  $a \leq 0$ , this

gluing is not tight by the Gluing Theorem (Theorem 1.3).

If  $a+b+c = 3$  then  $+, +, +$  is equivalent to  $-, -, -$  as follows. Define the layer  $L$  as in the previous paragraph.  $L$  has slopes  $1, -1$  as seen from  $T_1$ , and admits a factorization into two basic slices with slopes  $1, \infty$  and  $\infty, -1$ , and opposite signs. The two layers can be interchanged, since they form a continued fraction block. This has the effect of exchanging between  $+, +, +$  and  $-, -, -$ . If  $a+b+c > 3$  then this exchange cannot be performed, and the relative Euler class evaluated on  $\Sigma_0$  distinguishes the two. The unmixed situation is virtually overtwisted.

Next consider the situation where there are bypasses on  $\Sigma'_0$ . Then we may peel off at least one  $T^2 \times I$  layer with slopes  $\infty, \infty$  and  $\beta_I = \pi$ . Let  $L'_i$  be a  $T^2 \times I$  layer with slopes  $\infty, \infty$ , minimal boundary, and maximal  $\beta_I$ . Then  $(S^1 \times \Sigma'_0) \setminus (L'_1 \cup L'_2 \cup L'_3)$  will be  $S^1$ -invariant with  $\#\Gamma$ -minimizing dividing set of the base as in Figure 8. However, we cannot be in the unmixed case, because we may put back  $T^2 \times I$  layers onto  $(S^1 \times \Sigma'_0) \setminus (L'_1 \cup L'_2 \cup L'_3)$  with twisting less than  $\pi$  but enough to make the new boundary slopes satisfy  $a+b+c \leq 2$ . Hence, if  $\Sigma'_0$  has a bypass, the tight contact structure on  $S^1 \times \Sigma_0$  must be universally tight, and, by adding a minimally twisting layer  $L''_i$  compatible with  $L_i$  and  $L'_i$  (so  $L''_i \cup L_i \cup L'_i$  is tight), we obtain a unique extension to a universally tight structure on  $S^1 \times \Sigma''_0$  with slopes  $\infty$  on each boundary component  $T''_i$ .

Let  $a+b+c < 2$ . Assume first that the tight contact structure contains vertical Legendrians. This case can be treated in the same way as  $a+b+c \geq 2$ , with the exception that the tight structure must be universally tight (since  $+, +, +$  and  $-, -, -$  were ruled out in the no-bypass case above).

If the tight structure does not have a vertical Legendrian, then there must exist a vertical annulus  $A$  from  $T_2$  to  $T_3$  with dividing curves which are horizontal. Let  $N = N(T_2 \cup T_3 \cup A)$  with  $\partial N = T_2 + T_2 + T$ . Then,  $(S^1 \times \Sigma_0) \setminus N$  is a toric annulus with slopes  $a$  and  $-b-c+1$  (as seen from  $T_1$ ). There is still one degree of freedom that needs to be factored away — that is the holonomy of the dividing curves on  $A$ . On  $(S^1 \times \Sigma_0) \setminus N$ , take the annulus  $B = \gamma \times I$ , where  $\gamma$  is a closed curve with slope  $a$ . This produces bypasses along  $T$  which may be made almost vertical by bypass sliding. Hence, the bypass can be attached along  $A$ , and we may normalize the dividing curves to be horizontal in a manner similar to Lemma 3.7. There exist  $[(-b-c+1)-a]+1 > 0$  tight contact structures on the toric annulus with slopes  $a, -b-c+1$ . To actually exhibit a tight

model, again assume without loss of generality that  $b = c = 1$ ,  $a \leq -1$ , and drill out neighborhoods of twisting number  $-1$  Legendrians from a solid torus with boundary slope  $a$ . They are distinguished by the relative Euler class evaluated on  $\Sigma_0$ . q.e.d.

**Lemma 5.2.** *The tight contact structures on  $S^1 \times \Sigma_0$  with convex boundary, and boundary slopes  $\infty$  for  $T_1$  (boundary not necessarily minimal), and  $b, c \in \mathbb{Z}$  for  $T_2, T_3$  (minimal boundary) are given as follows:*

1. *All tight contact structures are universally tight.*
2. *There is a unique extension to  $S^1 \times \Sigma_0''$ , obtained by adding toric annuli  $L_i''$ ,  $i = 2, 3$  with minimal twisting and minimal boundary, so that all the boundary components have slope  $\infty$ . There is a 1-1 correspondence between universally tight contact structures on  $S^1 \times \Sigma_0$  and  $\#\Gamma$ -minimizing configurations of dividing curves on  $\Sigma_0''$ .*

*Proof.* As in the proof of Lemma 5.1, there exist minimally twisting layers  $L_2, L_3$  with slopes  $b, \infty$ ;  $c, \infty$ ; together with the complement  $S^1 \times \Sigma_0'$ . Assume  $\Sigma_0'$  is a  $\#\Gamma$ -minimizing convex surface with Legendrian boundary. Note that if  $\partial L_i = T_i - T_i'$ , then we could have chosen  $T_i'$ ,  $i = 2, 3$  to be minimal with slope  $\infty$ . If  $\Sigma_0'$  has bypasses along  $T_i'$ ,  $i = 2, 3$ , then there exists a  $T^2 \times I$  layer  $L_i'$  with  $\partial L_i' = T_i' - T_i'''$ ,  $T_i'''$  minimal convex with slope  $\infty$ , and  $\beta_I$  maximal amongst such layers. Now,  $L_i \cup L_i'$  is universally tight since  $\beta_I > \pi$ . Let  $S^1 \times \Sigma_0''' = (S^1 \times \Sigma_0') \setminus (L_2' \cup L_3')$ . Since  $L_i'$ ,  $i = 2, 3$ , are maximal, a  $\#\Gamma$ -minimizing  $\Sigma_0'''$  has no  $\partial$ -parallel components along  $T_i'$ ,  $i = 2, 3$ . Then either both dividing curves of  $\Sigma_0'''$  beginning at  $T_2'$  end at  $T_3'$ , or at least one dividing curve of  $\Sigma_0'''$  beginning at  $T_2'$  ends at  $T_1$  (and the same for  $T_3'$ ). In the latter case, when we glue  $L_i \cup L_i' \cup L_i''$  back on, no homotopically trivial dividing curves on  $\Sigma_0''$  are created, and the contact structure remains universally tight. In the former case, we may peel off a layer  $L_1$  with slopes  $\infty, a$  (any  $a \in \mathbb{Z}$ ), and the proof of Lemma 5.1 forces universal tightness of  $S^1 \times \Sigma_0$ . Once we know it is universally tight, the unique extension is immediate. q.e.d.

**Lemma 5.3.** *The tight contact structures on  $S^1 \times \Sigma_0$  with convex boundary, and boundary slopes  $a \in \mathbb{Z}$  for  $T_1$  (minimal boundary), and  $\infty, \infty$  for  $T_2, T_3$  (boundary not necessarily minimal) are given as follows:*

1. *All tight contact structures are universally tight.*

2. *There is a unique extension to  $S^1 \times \Sigma_0''$ , obtained by adding a toric annulus  $L_1''$  with minimal twisting, so that all the boundary components have slope  $\infty$ . There is a 1-1 correspondence between universally tight contact structures on  $S^1 \times \Sigma_0$  and  $\#\Gamma$ -minimizing configurations of dividing curves on  $\Sigma_0''$ .*

*Proof.* The proof is similar to the previous lemmas, but easier.

q.e.d.

**5.2. State traversal.** In this section we prove the tightness of the alleged virtually overtwisted contact structures using the method of *state traversal*, presented in Part 1.

We first describe our *initial state*. (The reader may verify that this indeed is the same contact structure described previously.) Decompose  $\Sigma = \Sigma_1 \cup \dots \cup \Sigma_k$ ,  $k = 2g - 2$ , into pairs-of-pants  $\Sigma_i$ , and  $M = (S^1 \times \Sigma_1) \cup \dots \cup (S^1 \times \Sigma_k)$ . Let  $N_i = S^1 \times \Sigma_i$ , and  $\partial N_i = T_1^i + T_2^i + T_3^i$ . Denote the slopes of  $T_\alpha^i$ ,  $\alpha = 1, 2, 3$ , by  $s_\alpha^i$ . We will often denote a common torus boundary (wall) of adjacent  $N_i$  and  $N_j$  by  $T_{ij}$  — there may be more than one component, but which one we refer to should be clear from context.

Let  $N_i$  have boundary slopes  $s_\alpha^i = a, b, c \in \mathbb{Z}$ . We stipulate that  $N_1$  is of type 3(c) in Lemma 5.1 and  $N_i$ ,  $i = 2, \dots, 2g - 2$ , are of type 4(b) in Lemma 5.1 and hence horizontal. Let us also take a minimal convex torus  $T \subset N_1$  with vertical slope, and write  $M \setminus T = S^1 \times \Sigma''$ , where  $\Sigma''$  is a  $\#\Gamma$ -minimizing convex surface and the tight contact structure on  $S^1 \times \Sigma''$  is  $S^1$ -invariant and universally tight.

Assume inductively that we have reached a state where:

1. Each  $N_i$  is tight.
2.  $T$  is a convex torus with vertical dividing curves ( $T$  is not necessarily minimal).
3.  $M \setminus T = S^1 \times \Sigma''$  is universally tight (i.e., the contact structure is  $S^1$ -invariant and a  $\#\Gamma$ -minimizing convex  $\Sigma''$  has no homotopically trivial dividing curves).
4.  $T \subset N_l$  for exactly one  $i = l$  (if  $T$  is a boundary component, then we push  $T$  into the interior), and  $T$  is parallel to one of the  $T_\alpha^l$ .
5. The dividing curves on  $\Sigma''$ , when projected down to  $\Sigma$ , glue to give one closed homotopically trivial curve.

Note that our initial state satisfies these properties. The inductive hypothesis also implies that all but possibly one  $N_l$  (the one containing  $T$ ) are universally tight. If at least one boundary component of  $N_l$  has vertical dividing curves, then  $N_l$  is also universally tight. (This follows from Lemma 5.3 or 5.2.) We prove that these properties still hold after each *state change*. Assume the state change takes place along  $T_{ij}$ , i.e., a layer is peeled off from  $T_i$  and attached to  $T_j$ . When modifying  $N_i$ ,  $N_j$ , and  $T_{ij}$  during traversal, we also modify  $T$  and  $\Sigma''$  so that  $T$  always has vertical dividing curves.

Now examine the possible layers that can be peeled off of  $N_i$ .

**Case 1.** Assume  $N_l$  containing  $T$  has no boundary in common with  $N_i$ . Then  $T$  and  $\Sigma''$  remain the same. The new  $N_j$  are clearly still universally tight since  $N_j \subset M \setminus T$ .

**Case 2A.** Assume that  $T \subset N_l$ , and the state change occurs along  $T_\alpha^l$ . Assume the boundary slopes  $s_\alpha^l$  are  $a, b, c \in \mathbb{Z}$ . We claim  $a + b + c > e - (2g - 2)$ . Assume  $a + b + c \leq e - (2g - 2)$ . If there exists a vertical Legendrian curve in  $M \setminus N_l$ , this would contradict the inductive assumption on  $\Gamma_{\Sigma''}$ . For there not to exist a vertical Legendrian curve

on  $N_k$ ,  $k \neq l$ , we need  $\sum_{\alpha=1}^3 s_\alpha^k \leq 1$  by Lemma 5.1. This implies that if

$M$  is cut open along any boundary torus of  $N_k$  and trivialized, then the difference in the boundary slopes is  $\sum_{k=1}^{2g-2} \sum_{\alpha=1}^3 s_\alpha^k \leq [e - (2g - 2)] + [2g - 3] = e - 1$ , short of the bundle contribution  $e$ , and we have a contradiction. Thus,  $a + b + c > e - (2g - 2) \geq 2$ .

Assume first that  $l = j$ , i.e., a layer is attached onto  $N_l$ . The  $T^2 \times I$  that is peeled off from  $N_i$  has slopes  $a' \neq \infty, a$  with  $a' + b + c > e - (2g - 2)$ ,  $a' \leq a$ , and no vertical Legendrian, since  $M \setminus N_l$  has no vertical Legendrian. We do not need to change  $T$ ,  $\Sigma''$ . Since  $M \setminus T$  is universally tight, the attachment of  $T^2 \times I$  to  $N_l$  preserves tightness.

Next assume  $l = i$ . If the  $T^2 \times I$  layer attached onto  $N_j$  has slopes  $-a', -a$ , with  $+\infty > a' \geq a$ , and no vertical Legendrian, then we do not change  $T$ ,  $\Sigma''$ , and the inductive assumption is easily satisfied. Therefore, assume  $T^2 \times I$  is minimally twisting with slopes  $-a', -a$ , where  $a' = \infty$  or  $-a' \geq b + c - 1$  (note  $-a \leq b + c - 3$ ). We may push  $T$  over into the neighboring  $N_j$  and modify  $\Sigma''$  as well, by the Section Change Lemma. The configuration of dividing curves will not change when projected down to  $\Sigma$ . We claim that  $N_j \cup (T^2 \times I)$  is tight. If  $a' = \infty$ ,



then we could have modified  $T$  using the Section Change Lemma, even before removing the  $T^2 \times I$ , so that  $T$  was the boundary component of  $T^2 \times I$  with slope  $\infty$ . The claim follows in this case since  $M$  cut open along the new  $T$  is universally tight. If  $a' \neq \infty$ , then, by Lemma 5.1,  $\sum_{\alpha=1}^3 s_{\alpha}^k \leq 1$  for  $k \neq i$ , and  $\sum_{\alpha=1}^3 s_{\alpha}^i + \sum_{\alpha=1}^3 s_{\alpha}^j \geq e - (2g - 4)$ . Combining this with the fact that the sum of slopes of  $N_i \setminus (T^2 \times I)$  is  $\leq 1$ , we see that the sum of slopes of  $N_j \cup (T^2 \times I)$  is  $\geq e - (2g - 3) \geq 3$ . Since the sum of slopes is consistent, and the layers are consistent, Lemma 5.1 proves the claim for  $a' \neq \infty$ .

When  $a, b, c \in \mathbb{Q}$ , the same proof holds with few changes. Since there is no vertical Legendrian in  $M \setminus N_l$ , there is a thickening of  $N_l$  to  $N'_l$ , by adding  $T^2 \times I$ 's, where  $N'_l$  has slopes  $\frac{\bar{a}}{n}, \frac{\bar{b}}{n}, \frac{\bar{c}}{n} \in \mathbb{Q}$ , with  $n \in \mathbb{Z}^+$  and  $(\bar{a}, n) = (\bar{b}, n) = (\bar{c}, n) = 1$ , and where  $M \setminus N'_l$  has no Legendrian  $\gamma$  isotopic to the fiber with twisting number  $t(\gamma) > -n$ . Here  $a \geq \frac{\bar{a}}{n}$ ,  $b \geq \frac{\bar{b}}{n}$ , and  $c \geq \frac{\bar{c}}{n}$ . Using a holonomy calculation similar to that of Lemma 3.2, we compute

$$e - \frac{2g - 3}{n} \leq \frac{\bar{a}}{n} + \frac{\bar{b}}{n} + \frac{\bar{c}}{n}.$$

Denote the greatest integer less than  $x$  by  $\lfloor x \rfloor$ .

**Claim.** 1.  $\lfloor \frac{\bar{a}}{n} \rfloor + \lfloor \frac{\bar{b}}{n} \rfloor + \lfloor \frac{\bar{c}}{n} \rfloor \geq 3$ , provided either  $g = 2$  and  $e \geq 5$  or  $g \geq 3$ .

2.  $\lfloor \frac{\bar{a}}{n} \rfloor + \lfloor \frac{\bar{b}}{n} \rfloor + \lfloor \frac{\bar{c}}{n} \rfloor \geq 2$ , if  $g \geq 2$  and  $e \geq 2g$ .

*Proof of Claim.* We will prove (1). It is easy to compute that the largest  $\bar{a} + \bar{b} + \bar{c}$  can be with  $\lfloor \frac{\bar{a}}{n} \rfloor + \lfloor \frac{\bar{b}}{n} \rfloor + \lfloor \frac{\bar{c}}{n} \rfloor < 3$  is  $5n - 3$ . For either of the conditions, we have  $\bar{a} + \bar{b} + \bar{c} \geq en - (2g - 3) > 5n - 3$ . Note that since  $e \geq 2g$ , we have  $2g(n - 1) + 3 \leq \bar{a} + \bar{b} + \bar{c}$ . q.e.d.

When (1) holds, we are able to prove the tightness of the contact structure on  $N'_l$  by embedding inside a model of type 3(c) in Lemma 5.1 with the help of the universal tightness of  $M \setminus T$ . When  $g = 2$  and  $e = 4$ , we can still write down models as in Lemma 5.1 obtained by removing Legendrian curves parallel to the  $S^1$ -fiber from a solid torus  $D^2 \times S^1$ . What we have shown is that  $N_l$  remains tight after peeling and reattaching, provided  $T$  remains inside  $N_l$  during this process.

**Case 2B.** Same assumptions as Case 2A, except  $a, b \in \mathbb{Q}$ , and  $c = \infty$ . Let us first consider  $l = j$ . Since  $T$  and  $\Sigma''$  do not change, we only check the tightness of  $N_l \cup (T^2 \times I)$ . If the layer is attached along  $T_{il}$  with rational slopes, then the universal tightness of  $M \setminus T$ , together with Lemmas 5.2, 5.3, implies that  $N \cup (T^2 \times I)$  remains tight. If the layer is attached along  $T_{il}$  with slope  $c = \infty$ , there are two cases: the layer has twisting or the layer does not have twisting. If the layer has no twisting, then attachment of the layer leaves  $N_l \cup (T^2 \times I)$  tight by examining the dividing curves of a section and using Proposition 4.6 (Unique Projection) — there cannot exist homotopically trivial dividing curves, because one of the torus boundary components has vertical slope, hence we have at least one arc in the dividing set apart from the homotopically trivial dividing curve, which contradicts (5). If the layer has twisting, then the layer must have boundary slopes  $\infty, c'$  with  $\lfloor a \rfloor + \lfloor b \rfloor + \lfloor c' \rfloor \geq 3$  for  $g > 2$  (or when at least one of  $a, b, c'$  is an integer) and  $\lfloor a \rfloor + \lfloor b \rfloor + \lfloor c' \rfloor \geq 2$  for  $g = 2$ , and there cannot be other vertical Legendrians away from  $N_l \cup (T^2 \times I)$ .

Next we examine the case where  $l = i$ . If the layer has slopes  $a, a' \in \mathbb{Q}$ , or  $a, a'$  with  $a' = \infty$  but the boundary minimal, then we do not need to change  $T$  and  $\Sigma''$ . If  $a' = \infty$  but the boundary is not minimal, we will modify  $T, \Sigma''$  if necessary so that they are parallel to the  $T_{lj}$  with slope  $c$  — to modify, use the Section Change Lemma. It is not possible for  $a, a' \in \mathbb{Q}$ , with a vertical Legendrian in this layer.

If the layer to be removed has slopes  $c = \infty$  and  $c' \in \mathbb{Q}$ , then we move  $T$  into the  $N_j$  and modify  $\Sigma''$  using the Section Change Lemma. We need to prove the tightness of  $N_j \cup (T^2 \times I)$ . There is no problem if at least two boundary components of  $N_j$  have slope  $\infty$ . If not, then none of the boundary components of  $N_j \cup (T^2 \times I)$  have vertical slope. We can now invoke Lemma 5.1, noting the restriction on the slopes that condition (5) forces.

**Case 2C.** Same assumptions as Case 2A, except  $a \in \mathbb{Q}$ , and  $b, c = \infty$ . First consider  $l = j$ . Universal tightness of  $N_j$  by Lemma 5.2 and universal tightness of  $M \setminus T$  imply that  $N_j \cup (T^2 \times I)$  is universally tight.  $T$  and  $\Sigma''$  remain the same.

Next assume  $l = i$ . If a layer is peeled off from the  $T_{lj}$  with slope  $a$ , then we modify  $T, \Sigma''$  if necessary so they are parallel to  $T_{lj}$  with slope  $c$ . If the layer is peeled off from  $T_{lj}$  with slope  $b = \infty$  (say), then we have two possibilities, as in Case 2B: either there is twisting or there is none. If there is none,  $N_j \cup (T^2 \times I)$  is clearly tight, since we could

modify  $T$  so it stays in  $N_l$ . If there is twisting, we need to push  $T$  into  $N_j \times (T^2 \times I)$ , and this is tight since at least one boundary component of  $N_j \times (T^2 \times I)$  has  $\infty$  slope.

**Case 2D.** Same as Case 2A, except  $a, b, c = \infty$ . Attaching layers onto  $N_l$  is easy. Removing layers is similar to Case 2C.

This completes the proof of the tightness.

There exist 2 distinct such tight structures when  $e > 2g$  and 1 such tight structure when  $e = 2g$ . The 2 tight structures are homotopically distinct when  $e > 2g$ , but can be identified when  $e = 2g$  — this is due to 3(c) in Lemma 5.1. This completes the proof of the classification.

q.e.d.

**Conjecture 5.4.** *The virtually overtwisted contact structures with  $t(S^1) = 0$  are not symplectically semi-fillable.*

### Appendix: Bypass sliding

Let  $F$  be a closed convex surface, or a compact convex surface with Legendrian boundary, and  $\Gamma_F$  be its dividing set. Also let  $D$  be a bypass half-disk, and  $\delta$  be a boundary component of  $D$  which we usually call the bypass; we may assume the endpoints  $p, q$  of  $\delta$  lie on  $\Gamma_F$ . Let  $\gamma_p, \gamma_q$  be the dividing curves containing  $p, q$ , respectively. Assume  $D$  is positioned as in Figure 9. When we construct new bypasses out of given ones, it is usually convenient to think of the new bypasses as translates of the given ones, and that the translation happens *along the dividing curves*. We can talk about moving the endpoints ‘up’ or ‘down’ — ‘up’ is the upward direction in Figure 9, and ‘down’ is the opposite direction.

**Lemma 5.5** (Bypass sliding).

1. *If  $\gamma_p \neq \gamma_q$ , then it is possible to slide the endpoints  $p, q$  up and down along  $\gamma_p, \gamma_q$ , respectively, as much as desired.*
2. *If  $\gamma_p = \gamma_q$ , then it is possible to slide  $q$  up (or  $p$  down) as much as desired, along  $\gamma_p = \gamma_q$ ; however, we are only allowed to slide  $q$  down (or  $p$  up) as long as the endpoints of the bypass do not cross.*

*Proof.* Let  $F_0$  be the component of  $F \setminus \Gamma_F$  to the left of  $\gamma_q$ .  $F_0$  deformation retracts onto its *skeleton*, i.e., the network of singular points (all of the same sign) and trajectories connecting them. In particular,

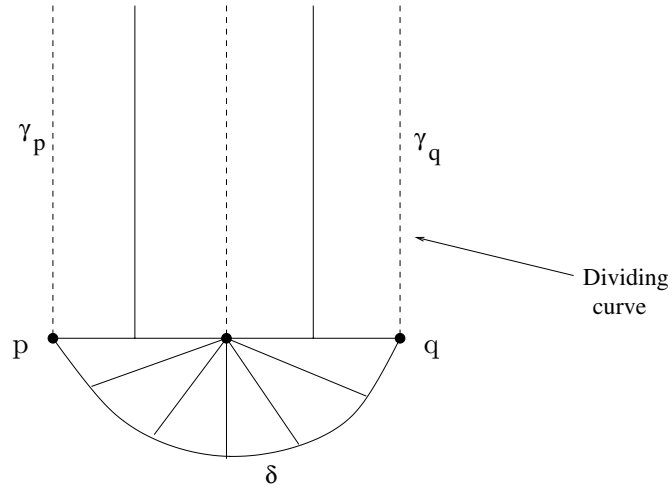

Figure 9: Bypass slides

there is a subset  $\sigma$  of the skeleton which is a curve parallel to  $\gamma_q$ . Modify the characteristic foliation in a  $C^0$ -small neighborhood of  $\sigma$  so that the characteristic foliation on the strip from  $\sigma$  to  $\gamma_q$  is in *standard form*. In particular, all the points of  $\sigma$  are tangencies.

If we want to move  $q$  up along  $\gamma_q$ , then round the edge of  $D - q$  can then be connected to  $\sigma$  by a Legendrian arc. We now follow  $\sigma$  upwards until the desired height, and round in the other direction, to move the endpoint of the Legendrian onto  $\gamma_q$ . This procedure does not change the twisting of the Legendrian relative to the reference half-disk. Moving  $q$  down is similar.

If  $\gamma_p = \gamma_q$  and  $q$  is moved down, then it is still possible to move  $q$  down past  $p$ , but the bypass half-disk will have self-intersections. In the other situations, there is no problem. q.e.d.

**Acknowledgements.** I would like to thank John Etnyre for helpful e-mail exchanges and conversations, as well as Richard Hain, Makoto Matsumoto and Robert Bryant for helping me with  $SL(2, \mathbb{Z})$ . I am also grateful to Will Kazez and Gordana Matić for their interest and support (with extra thanks to Will Kazez for help with Proposition 4.4).

## References

- [1] V. Colin, *Recollement de variétés de contact tendues*, Bull. Soc. Math. France **127** (1999) 43-69.
- [2] ———, *Sur la torsion des structures de contact tendues*, Preprint, 1999.
- [3] Y. Eliashberg, *Classification of overtwisted contact structures on 3-manifolds*, Invent. Math. **98** (1989) 623-637.
- [4] ———, *Contact 3-manifolds, twenty years since J. Martinet's work*, Ann. Inst. Fourier **42** (1992) 165-192.
- [5] Y. Eliashberg & W. Thurston, *Confoliations*, Amer. Math. Soc. (1998), Providence, RI.
- [6] J. Etnyre, *Contact structures on lens spaces*, to appear in Comm. in Contemp. Math.
- [7] E. Giroux, *Une structure de contact, même tendue, est plus ou moins tordue*, Ann. Scient. Ec. Norm. Sup. **27** (1994) 697-705.
- [8] ———, *Convexité en topologie de contact*, Comm. Math. Helv. **66** (1991) 637-677.
- [9] ———, *Une infinité de structures de contact tendues sur une infinité de variétés*, Invent. Math. **135** (1999) 789-802.
- [10] ———, *Structures de contact en dimension trois et bifurcations des feuilletages de surfaces*, Invent. Math. **141** (2000), 615–689.
- [11] ———, *Structures de contact sur les variétés fibrées en cercles au-dessus d'une surface*, to appear in Comm. Math. Helv.
- [12] R. Gompf, *Handlebody construction of Stein surfaces*, Ann. of Math. **148** (1998) 619-693.
- [13] K. Honda, *On the classification of tight contact structures I*, Geom. Topol. **4** (2000), 309–368.
- [14] Y. Kanda, *The classification of tight contact structures on the 3-torus*, Comm. in Anal. and Geom. **5** (1997) 413-438.
- [15] J. Milnor, *On the existence of a connection with curvature zero*, Comm. Math. Helv. **32** (1957-58) 215-223.
- [16] A. Sato & T. Tsuboi, *Contact structures of closed manifolds fibered by the circles*, Mem. Inst. Sci. Tech. Meiji Univ. **33** (1994) 41-46.
- [17] J. Wood, *Bundles with totally disconnected structure group*, Comm. Math. Helv. **46** (1971) 257-279.