

# Super $q$ –Howe duality and web categories

DANIEL TUBBENHAUER

PEDRO VAZ

PAUL WEDRICH

We use super  $q$ –Howe duality to provide diagrammatic presentations of an idempotent form of the Hecke algebra and of categories of  $\mathfrak{gl}_N$ –modules (and, more generally,  $\mathfrak{gl}_{N|M}$ –modules) whose objects are tensor generated by exterior and symmetric powers of the vector representations. As an application, we give a representation-theoretic explanation and a diagrammatic version of a known symmetry of colored HOMFLY–PT polynomials.

57M25, 81R50

## 1 Introduction

Let  $U_q(\mathfrak{gl}_N)$  be the quantum enveloping  $\mathbb{C}_q = \mathbb{C}(q)$ –algebra for  $\mathfrak{gl}_N$  with  $q$  being generic. Let  $\mathfrak{gl}_N\text{–Mod}_{\text{es}}$  denote the braided monoidal category of  $U_q(\mathfrak{gl}_N)$ –modules<sup>1</sup> tensor generated by exterior  $\bigwedge_q^k \mathbb{C}_q^N$  and symmetric  $\text{Sym}_q^l \mathbb{C}_q^N$  powers and  $U_q(\mathfrak{gl}_N)$ –intertwiners between them.

We denote by  $\check{H}$  an *idempotent version* of the direct sum of all Iwahori–Hecke algebras  $H_\infty(q) = \bigoplus_{K \in \mathbb{Z}_{\geq 0}} H_K(q)$  of type  $A$ . Roughly,  $\check{H}$  is the category obtained from the one-object category  $H_\infty(q)$  by adding formal Gyoja–Aiston idempotents corresponding to column and row Young diagrams as new objects.<sup>2</sup> By *quantum Schur–Weyl duality*, the categories  $\mathfrak{gl}_N\text{–Mod}_{\text{es}}$  are quotients of  $\check{H}$  and the added idempotents can be thought of as lifts of the exterior  $\bigwedge_q^k \mathbb{C}_q^N$  and the symmetric  $\text{Sym}_q^l \mathbb{C}_q^N$  powers.

We construct diagrammatic presentations of  $\check{H}$  and  $\mathfrak{gl}_N\text{–Mod}_{\text{es}}$  by using the *green–red* web categories  $\infty\text{–Web}_{\text{gr}}$  and  $N\text{–Web}_{\text{gr}}$ . Morphisms in these  $\mathbb{C}_q$ –linear categories are combinations of planar, upward-oriented, trivalent graphs with edges labeled by positive integers and colored black, green or red<sup>3</sup> modulo local relations. Objects are

<sup>1</sup>We only consider finite-dimensional, left modules (of type 1) throughout the paper.

<sup>2</sup>Adding only column idempotents, one obtains the type  $A$  Schur algebroids introduced by Williamson in [30].

<sup>3</sup>We use colored diagrams in this paper. The colors (black, green and red) are important and we recommend to read the paper in color. If the reader has a black-and-white version, then green will appear lightly shaded and black and red can be distinguished since black edges are always labeled 1.

boundaries of such green–red webs, ie finite sequences of positive integers, each of which additionally carries the color black, green or red, indicated either by an actual coloring or by a subscript.

An example of a green–red web is:

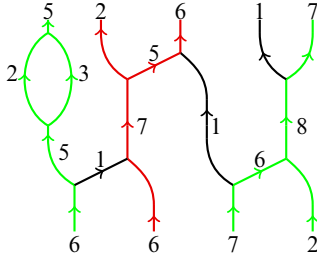

A green integer  $k$  in a boundary sequence is meant to correspond to the  $U_q(\mathfrak{gl}_N)$ -module  $\bigwedge_q^k \mathbb{C}_q^N$ , a red integer  $l$  to  $\text{Sym}_q^l \mathbb{C}_q^N$ , and sequences of integers correspond to tensor products of such. Vertical edges are identities on these  $U_q(\mathfrak{gl}_N)$ -modules and trivalent vertices encode more interesting  $U_q(\mathfrak{gl}_N)$ -intertwiners. The integer 1 should be  $\mathbb{C}_q^N \cong \bigwedge_q^1 \mathbb{C}_q^N \cong \text{Sym}_q^1 \mathbb{C}_q^N$  independent of the color green or red, so we color it black.

Our main result is:

**Theorem** (The diagrammatic presentation) *The additive closures of  $\infty\text{-Web}_{\text{gr}}$  and of  $N\text{-Web}_{\text{gr}}$  are braided monoidally equivalent to  $\mathbf{H}$  and  $\mathfrak{gl}_N\text{-Mod}_{\text{es}}$ , respectively.*

We will see that  $\infty\text{-Web}_{\text{gr}}$  admits an involution interchanging the colors green and red. An almost direct consequence of this is a symmetry between the HOMFLY-PT polynomial  $\mathcal{P}^{a,q}(\cdot)$  of a link  $\mathcal{L}$  colored with  $\vec{\lambda} = (\lambda^1, \dots, \lambda^d)$  and the HOMFLY-PT polynomial of  $\mathcal{L}$  colored with  $\vec{\lambda}^T = ((\lambda^1)^T, \dots, (\lambda^d)^T)$ :

**Proposition** (The colored HOMFLY-PT symmetry) *We have*

$$(1-1) \quad \mathcal{P}^{a,q}(\mathcal{L}(\vec{\lambda})) = (-1)^c \mathcal{P}^{a,q^{-1}}(\mathcal{L}(\vec{\lambda}^T)).$$

Here  $c$  is the sum of the number of nodes in the Young diagrams  $\lambda^i$  for  $1 \leq i \leq d$ .

Our results might help to understand symmetries observed within the homologies that categorify the colored HOMFLY-PT polynomials; see Gukov and Stošić [10, Section 5].

Moreover, we show that a straightforward generalization of our approach also leads to diagrammatic presentations for categories  $\mathfrak{gl}_{N|M}\text{-Mod}_{\text{es}}$  of  $U_q(\mathfrak{gl}_{N|M})$ -modules tensor generated by exterior and symmetric powers of the vector representation. The presentations are given by quotients  $N|M\text{-Web}_{\text{gr}}$  of  $\infty\text{-Web}_{\text{gr}}$ , which are obtained by killing Gyoja–Aiston idempotents corresponding to box-shaped Young diagrams.

### 1.1 The framework

A prototypical diagrammatic presentation result (with roots in the work of Rumer, Teller and Weyl [26]) states that the *Temperley–Lieb category* gives a presentation of the full subcategory of  $U_q(\mathfrak{sl}_2)$ -modules tensor generated by the vector representation  $\mathbb{C}_q^2$ . Kuperberg [15] extended this to all rank-2 Lie algebras. In particular, he described a presentation of the full subcategory of  $U_q(\mathfrak{sl}_3)$ -modules tensor generated by the *exterior powers*  $\bigwedge_q^1 \mathbb{C}_q^3 \cong \mathbb{C}_q^3$  and  $\bigwedge_q^2 \mathbb{C}_q^3$ . More generally, Cautis, Kamnitzer and Morrison [3] gave a presentation of  $\mathfrak{gl}_N\text{-Mod}_e$ , the full subcategory of  $U_q(\mathfrak{gl}_N)$ -modules tensor generated by the *exterior powers*  $\bigwedge_q^k \mathbb{C}_q^N$  for  $k = 0, \dots, N$ .

One of their key ideas in [3] is the usage of *skew quantum Howe duality* (or, short, *skew  $q$ -Howe duality*). In order to explain their approach, let  $\vec{k} \in \mathbb{Z}_{\geq 0}^m$  be such that  $k_1 + \dots + k_m = K$ . By skew  $q$ -Howe duality, the commuting actions of  $U_q(\mathfrak{gl}_m)$  and  $U_q(\mathfrak{gl}_N)$  on

$$\bigwedge_q^K (\mathbb{C}_q^m \otimes \mathbb{C}_q^N) \cong \bigoplus_{\vec{k} \in \mathbb{Z}_{\geq 0}^m} \bigwedge_q^{k_1} \mathbb{C}_q^N \otimes \dots \otimes \bigwedge_q^{k_m} \mathbb{C}_q^N$$

give rise to a functor  $\Phi_{\text{skew}}^m: \dot{U}_q(\mathfrak{gl}_m) \rightarrow \mathfrak{gl}_N\text{-Mod}_e$ , where  $\dot{U}_q(\mathfrak{gl}_m)$  is the idempotent form of  $U_q(\mathfrak{gl}_m)$ . Then Cautis, Kamnitzer and Morrison construct a commutative diagram, which takes the following form in our notation:<sup>4</sup>

$$(1-2) \quad \begin{array}{ccc} \dot{U}_q(\mathfrak{gl}_m) & \xrightarrow{\Phi_{\text{skew}}^m} & \mathfrak{gl}_N\text{-Mod}_e \\ & \searrow \Upsilon_{\text{skew}}^m & \uparrow \Gamma \\ & & N\text{-Web}_g \end{array}$$

Here  $\Upsilon_{\text{skew}}^m$  is a certain *ladder functor* realizing an action of  $\dot{U}_q(\mathfrak{gl}_m)$  on the diagram category  $N\text{-Web}_g$ . The *presentation functor*  $\Gamma$  is constructed so that (1-2) commutes. The functor  $\Phi_{\text{skew}}^m$  is full and its kernel is generated by killing  $\mathfrak{gl}_m$ -weights with entries not in  $\{0, \dots, N\}$ . That  $\Gamma$  is an equivalence follows since  $N\text{-Web}_g$  is defined to be the quotient of a “free” web category by relations coming from  $\dot{U}_q(\mathfrak{gl}_m)$  (to make the ladder functor  $\Upsilon_{\text{skew}}^m$  well-defined) and the  $\Upsilon_{\text{skew}}^m$  image of the kernel of  $\Phi_{\text{skew}}^m$ .  $\mathfrak{sl}_N\text{-Mod}_e$  can be recovered by identifying  $\bigwedge_q^k \mathbb{C}_q^N \cong (\bigwedge_q^{N-k} \mathbb{C}_q^N)^*$  as  $U_q(\mathfrak{sl}_N)$ -modules.

Rose and the first-named author [25] studied the situation of *symmetric quantum Howe duality* (for short, *symmetric  $q$ -Howe duality*).<sup>5</sup> That is, there is an analogue of (1-2) where  $\mathfrak{gl}_N\text{-Mod}_e$  is replaced by  $\mathfrak{gl}_N\text{-Mod}_s$ , the full subcategory of  $U_q(\mathfrak{gl}_N)$ -modules tensor generated by the *symmetric powers*  $\text{Sym}_q^l \mathbb{C}_q^N$  for  $l \in \mathbb{Z}_{\geq 0}$ . In the  $N = 2$  case,

<sup>4</sup>We consider  $\mathfrak{gl}_N\text{-Mod}_{es}$  instead of  $\mathfrak{sl}_N\text{-Mod}_{es}$ ; see also Remark 1.1.

<sup>5</sup>In fact, the observations made in [25] were one of the main motivations to start this project.

the kernel of  $\Phi_{\text{sym}}^m$  is generated by killing  $\mathfrak{gl}_m$ -weights with negative entries and one additional *dumbbell relation*, which encodes the relation  $\mathbb{C}_q^2 \otimes \mathbb{C}_q^2 \cong \mathbb{C}_q \oplus \text{Sym}_q^2 \mathbb{C}_q^2$  in  $\mathfrak{gl}_2\text{-Mod}_s$ . A direct generalization for  $N > 2$  would require additional complicated relations besides killing  $\mathfrak{gl}_m$ -weights.

In this paper we give a diagrammatic presentation of the category  $\mathfrak{gl}_N\text{-Mod}_{\text{es}}$ , the full subcategory of  $U_q(\mathfrak{gl}_N)$ -modules tensor generated by both exterior *and* symmetric powers of the vector representation. This diagrammatic presentation gives a common generalization of the web categories of [3] (only black–green webs) and [25] (only black–red webs). We see Cautis, Kamnitzer and Morrison’s approach as a *machine* that takes dualities and produces diagrammatic presentations of the related representation-theoretical categories. Specifically, we start with *super quantum Howe duality* (for short, super  $q$ -Howe duality) between the superalgebra  $U_q(\mathfrak{gl}_{m|n})$  and  $U_q(\mathfrak{gl}_N)$ . We obtain a full super  $q$ -Howe functor  $\Phi_{\text{su}}^{m|n}$ , which we attempt to factor as a composite of a ladder functor  $\Upsilon_{\text{su}}^{m|n}$  — mapping into an appropriate web category — and a diagrammatic presentation functor  $\Gamma_N$ , to give an analogue of the commutative diagram (1-2).<sup>6</sup>

$$\begin{array}{ccc}
 \dot{U}_q(\mathfrak{gl}_{m|n}) & \xrightarrow{\Phi_{\text{su}}^{m|n}} & \mathfrak{gl}_N\text{-Mod}_{\text{es}}^{\text{sort}} \\
 & \searrow \Upsilon_{\text{su}}^{m|n} & \uparrow \Gamma_N^{\text{sort}} \\
 & & N\text{-Web}_{\text{gr}}^{\text{sort}}
 \end{array}$$

Having decided to follow this strategy, the definition of the appropriate web category is already determined. Two aspects are important:

- (I) In order to make  $\Upsilon_{\text{su}}^{m|n}$  well-defined, the web category needs to satisfy ladder images of  $\dot{U}_q(\mathfrak{gl}_{m|n})$  relations. Remarkably, it suffices to consider relations coming from the subalgebra  $\dot{U}_q(\mathfrak{gl}_m) \oplus \dot{U}_q(\mathfrak{gl}_n)$  and only one additional *super commutation* relation  $[2]1_{\vec{k}} = F_m E_m 1_{\vec{k}} + E_m F_m 1_{\vec{k}}$  for  $\mathfrak{gl}_{m|n}$ -weights with  $k_m = k_{m+1} = 1$ . This corresponds to the *dumbbell relation* on webs and to  $\mathbb{C}_q^N \otimes \mathbb{C}_q^N \cong \wedge_q^2 \mathbb{C}_q^N \oplus \text{Sym}_q^2 \mathbb{C}_q^N$  in  $\mathfrak{gl}_N\text{-Mod}_{\text{es}}$ .
- (II) In order to make the diagrammatic presentation functor an equivalence, we need to impose the ladder image of  $\ker(\Phi_{\text{su}}^{m|n})$  as relations in the web category. In fact,  $\ker(\Phi_{\text{su}}^{m|n})$  is spanned by idempotents corresponding to  $\mathfrak{gl}_{m|n}$ -weights  $\vec{k} = (k_1, \dots, k_{m+n})$  with  $k_1, \dots, k_m \notin \{0, \dots, N\}$  or  $k_{m+1}, \dots, k_{m+n} \notin \mathbb{Z}_{\geq 0}$ . It is remarkable that no extra relations, aside from killing these  $\mathfrak{gl}_{m|n}$ -weights, are necessary.

<sup>6</sup>Here the superscript “sort” indicates subcategories in which exterior powers are *sorted* to the left of symmetric powers in tensor products. This small technical restriction stems from the use of super  $q$ -Howe duality, but will be removed later on.

We impose the ladder images of  $\ker(\Phi_{\text{su}}^{m|n})$  in two steps: first we kill all  $\mathfrak{gl}_{m|n}$ -weights with negative entries by allowing only nonnegative labels on web edges. This produces the web category  $\infty\text{-Web}_{\text{gr}}$ , which is symmetric under exchanging green and red. On this we further quotient by setting  $\mathfrak{gl}_{m|n}$ -weights  $\vec{k} = (k_1, \dots, k_{m+n})$  to zero if one of  $k_1, \dots, k_m$  is greater than  $N$ . This produces the web category  $N\text{-Web}_{\text{gr}}$  and in [Theorem 3.20](#) we show that its additive closure is equivalent to  $\mathfrak{gl}_N\text{-Mod}_{\text{es}}$ . Note that, although our graphical calculus is finer than the one in [\[3\]](#) in the sense that it contains more objects, the Karoubi envelopes of these diagrammatic categories agree for each  $N$ .

In [Theorem 3.22](#) we use *quantum Schur–Weyl duality* to derive from [Theorem 3.20](#) that  $\infty\text{-Web}_{\text{gr}}$  gives a diagrammatic presentation of the idempotent Iwahori–Hecke algebra  $\check{H}$  from above.

**Remark 1.1** We describe  $\mathfrak{gl}_N\text{-Mod}_{\text{es}}$  and not  $\mathfrak{sl}_N\text{-Mod}_{\text{es}}$  because of the algebraic form of super  $q$ -Howe duality. In particular, our web categories do not contain duality isomorphisms  $\bigwedge_q^k \mathbb{C}_q^N \cong (\bigwedge_q^{N-k} \mathbb{C}_q^N)^*$ , which would be necessary for a diagrammatic presentation of  $\mathfrak{sl}_N\text{-Mod}_{\text{es}}$ . In  $\mathfrak{gl}_N\text{-Mod}_{\text{es}}$ , on the other hand, there are no such hidden duals, as we have  $\bigwedge_q^k \mathbb{C}_q^N \cong \bigwedge_q^N \mathbb{C}_q^N \otimes (\bigwedge_q^{N-k} \mathbb{C}_q^N)^*$  as  $U_q(\mathfrak{gl}_N)$ -modules. Here  $\bigwedge_q^N \mathbb{C}_q^N \cong L((1, \dots, 1))$  is the  $U_q(\mathfrak{gl}_N)$ -module of highest weight  $\lambda = (1, \dots, 1) \in \mathbb{Z}_{\geq 0}^N$ .

Last, but not least, we use the more general *super  $q$ -Howe duality between  $U_q(\mathfrak{gl}_{m|n})$  and  $U_q(\mathfrak{gl}_{N|M})$*  to describe  $\mathfrak{gl}_{N|M}\text{-Mod}_{\text{es}}$ . Feeding this duality into the “diagrammatic presentation machine” shows that this representation category is equivalent to the quotient  $N|M\text{-Web}_{\text{gr}}$  of  $\infty\text{-Web}_{\text{gr}}$ , which is obtained by killing the Gyoja–Aiston idempotent corresponding to the size  $(N + 1) \times (M + 1)$  box-shaped Young diagram. This is a generalization, since, for  $M = 0$ ,  $\mathfrak{gl}_{N|M}\text{-Mod}_{\text{es}}$  is equivalent to  $\mathfrak{gl}_N\text{-Mod}_{\text{es}}$  and  $N|M\text{-Web}_{\text{gr}}$  is equal to  $N\text{-Web}_{\text{gr}}$ , because the box idempotent corresponds exactly to an  $(N + 1)$ -labeled green edge.

This generalizes Grant’s [\[9\]](#) and Sartori’s [\[28\]](#) presentations of the category  $\mathfrak{gl}_{1|1}\text{-Mod}_{\text{e}}$ , and the diagrammatic calculus for  $\mathfrak{gl}_{N|M}\text{-Mod}_{\text{e}}$  given by Queffelec and Sartori [\[23\]](#) (see also Grant [\[8\]](#)). Compared to the latter, our generalization, which also takes the symmetric powers of  $\mathbb{C}_q^{N|M}$  into account, does not need any extra relations aside from the dumbbell relation. In fact, the one extra relation needed to make the diagrammatic calculus given in [\[23\]](#) faithful — see [\[23, Remark 6.19\]](#) — has a very compact and natural description in our green–red web category  $N|M\text{-Web}_{\text{gr}}$ .

Finally, we sketch how our presentation of  $\mathfrak{gl}_{N|M}\text{-Mod}_{\text{es}}$  extends to take duals of exterior and symmetric powers into account. This closely follows [\[23, Section 6\]](#). The

resulting diagrammatic category allows the computation of the colored Reshetikhin–Turaev  $\mathfrak{gl}_{N|M}$ -link invariants. In [Corollary 5.13](#), we interpret the colored HOMFLY–PT symmetry (1-1) as a stable version of a symmetry between colored Reshetikhin–Turaev  $\mathfrak{gl}_{N|M}$ - and  $\mathfrak{gl}_{M|N}$ -link invariants.

## 1.2 Outline of the paper

[Section 2](#) is the diagrammatic heart of our paper, where we introduce  $\infty\text{-Web}_{\text{gr}}$  and its subquotients  $N\text{-Web}_{\text{gr}}$ ,  $N\text{-Web}_{\text{g}}$  and  $N\text{-Web}_{\text{r}}$ .

[Section 3](#) contains the proof of our main theorems and splits into three subsections: We first introduce super  $q$ -Howe duality. Then we show an equivalence between “sorted” subcategories of  $N\text{-Web}_{\text{gr}}$  and  $\mathfrak{gl}_N\text{-Mod}_{\text{es}}$ . These subcategories are induced by the algebraic form of super  $q$ -Howe duality. By using the “sorted” equivalence and the fact that the braiding gives a way to “shuffle” the “sorted” subcategories, we prove our main theorems.

In [Section 4](#) we discuss one application of our diagrammatic presentation: we give a procedure to recover the colored HOMFLY–PT polynomial from  $\infty\text{-Web}_{\text{gr}}$ . A direct consequence of the green–red symmetry is a symmetry within the colored HOMFLY–PT polynomial obtained by transposing Young diagrams, see (1-1). The colored Reshetikhin–Turaev  $\mathfrak{sl}_N$ -link polynomials can be recovered from our approach as well, as we sketch in the last subsection.

Finally, in [Section 5](#) we generalize the diagrammatic presentation of  $\mathfrak{gl}_N\text{-Mod}_{\text{es}}$  to the super case  $\mathfrak{gl}_{N|M}\text{-Mod}_{\text{es}}$ , and we sketch an extension of our diagrammatic calculus to include dual representations. The required arguments are — mutatis mutandis — contained in the previous sections and in [[23](#), [Section 6](#)], which allows a very compact exposition in [Section 5](#).

**Acknowledgements** We especially thank Antonio Sartori for a careful reading of a draft version of this paper and many helpful comments, and David Rose — some of the ideas underlying this paper came up in the joint work between him and DT. We also thank Jonathan Brundan, Jonathan Grant, Jonathan Kujawa, Marco Mackaay, Weiwei Pan, Jake Rasmussen, Marko Stošić, Catharina Stroppel, Geordie Williamson and Oded Yacobi for helpful discussion, comments, and probing questions, and two referees for some further helpful comments. We also like to thank Skype for many useful conversations.

DT was supported by a research funding of the “Deutsche Forschungsgemeinschaft (DFG)” during the main part of this work. DT and PW thank the center of excellence

grant ‘‘Centre for Quantum Geometry of Moduli Spaces (QGM)’’ from the ‘‘Danish National Research Foundation (DNRF)’’ for sponsoring a research visit which started this project. PV was financially supported by the ‘‘Universit  catholique de Louvain, Fonds Sp ciaux de Recherche (FSR) 12 J A’’. PW was supported by an EPSRC doctoral training grant.

## 2 The diagrammatic categories

In the present section we introduce the category  $\infty\text{-Web}_{\text{gr}}$  and its quotient  $N\text{-Web}_{\text{gr}}$ . These provide diagrammatic presentations of  $\mathbf{H}$  and its quotient categories  $\text{gl}_N\text{-Mod}_{\text{es}}$  respectively. Other subquotients of  $\infty\text{-Web}_{\text{gr}}$  are  $N\text{-Web}_g$  and  $N\text{-Web}_r$  (and later in Section 5,  $N|M\text{-Web}_{\text{gr}}$ ) which are related to categories studied in [3] and [25], respectively.

### 2.1 Definition of the category $\infty\text{-Web}_{\text{gr}}$ and its subquotients

We first introduce the *free green–red web category*  $\infty\text{-Web}_{\text{gr}}^f$ . To this end, we denote by  $X$  the set

$$X = X_b \cup X_g \cup X_r = \{0_b, 1_b\} \cup \{2_g, 3_g, \dots\} \cup \{2_r, 3_r, \dots\},$$

where we think of the elements of  $X_b$  as being colored *black*, of the elements of  $X_g$  as being colored *green* and of the elements of  $X_r$  as being colored *red*. We usually omit the subscripts, since the colors on the boundary can be read off from the diagrams.

**Definition 2.1** The *free green–red web category*, which we denote by  $\infty\text{-Web}_{\text{gr}}^f$ , is the category determined by the following data:

- The objects of  $\infty\text{-Web}_{\text{gr}}^f$  are finite (possibly empty) sequences  $\vec{k} \in X^L$  with entries from  $X$  for some  $L \in \mathbb{Z}_{\geq 0}$ , together with a zero object. We display the entries of  $\vec{k}$  ordered from left to right according to their appearance in  $\vec{k}$ .
- The morphism space  $\text{Hom}_{\infty\text{-Web}_{\text{gr}}^f}(\vec{k}, \vec{l})$  from  $\vec{k}$  to  $\vec{l}$  is the  $\mathbb{C}_q$ -vector space spanned by isotopy classes<sup>7</sup> of planar, upward-oriented, trivalent graphs with edges labeled by positive integers and colored black, green or red, with bottom boundary  $\vec{k}$  and top boundary  $\vec{l}$ . More precisely, we only allow webs that can be obtained by composition  $\circ$  (vertical gluing) and taking the monoidal product  $\otimes$  (horizontal juxtaposition) of the following basic pieces (including the empty diagram).

<sup>7</sup>We require that isotopies preserve the upward orientations and the boundary of green–red webs.

Let  $k, l \in \mathbb{Z}_{\geq 2}$ ; then the generators are

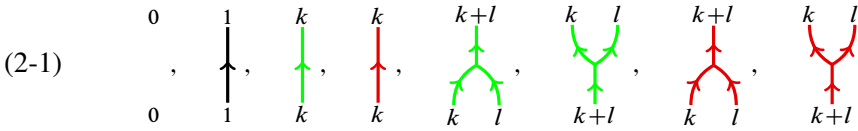

called (from left to right) *empty identity*, *black identity*, *green identity*, *red identity*, *green merge*, *green split*, *red merge* and *red split*, together with (here  $k, l \in \mathbb{Z}_{\geq 0}$ )

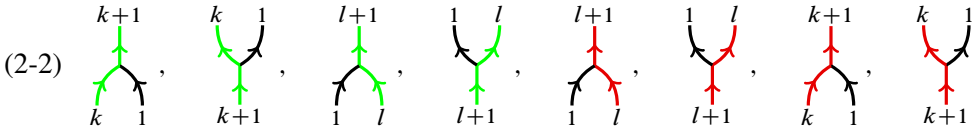

called *mixed merges* and *mixed splits*, respectively. (We also include versions of these involving edges labeled 0, which we, as in (2-1), do not illustrate.)

We call webs obtained by composition of generators with only black and green edges or only black and red edges *monochromatic*; cf (2-3).  $\diamond$

**Remark 2.2** Note the following conventions and properties of  $\infty\text{-Web}_{\text{gr}}^f$ :

- The category is  $\mathbb{C}_q$ -linear, ie the spaces  $\text{Hom}_{\infty\text{-Web}_{\text{gr}}^f}(\vec{k}, \vec{l})$  are  $\mathbb{C}_q$ -vector spaces and the composition  $\circ$  is  $\mathbb{C}_q$ -bilinear. Moreover, the category is monoidal by juxtaposition  $\otimes$  of objects and morphisms.  $\otimes$  is also  $\mathbb{C}_q$ -bilinear on morphism spaces.
- It is sometimes convenient in illustrations to allow green and red edges with label 1. By convention, these edges are to be read as being black:

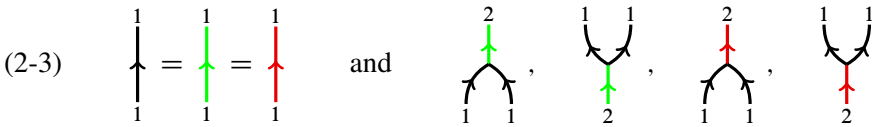

For example, the diagrams on the right are obtained by setting  $k = 1$  or  $l = 1$  in (2-2).

- The reading conventions for all webs are from *bottom to top* and *left to right*: if  $u$  and  $v$  are webs, then  $v \circ u$  is obtained by gluing  $v$  on top of  $u$  and  $u \otimes v$  is given by putting  $v$  to the right of  $u$ . Moreover, if any of the top boundary labels of  $u$  differs from the corresponding bottom boundary label of  $v$ , then, by convention,  $v \circ u = 0$ .
- For  $j \in \mathbb{Z}_{\geq 1}$ , we define the so-called *monochromatic  $F^{(j)}_{1(k,l)}$ - and  $E^{(j)}_{1(k,l)}$ -ladders* as



$$(2-4) \quad F^{(j)}1_{(k,l)} = \begin{array}{c} k-j \quad l+j \\ \nearrow \quad \nearrow \\ \searrow \quad \nearrow \\ \nearrow \quad \searrow \\ k \quad l \end{array}, \quad E^{(j)}1_{(k,l)} = \begin{array}{c} k+j \quad l-j \\ \nearrow \quad \nearrow \\ \searrow \quad \nearrow \\ \nearrow \quad \searrow \\ k \quad l \end{array}$$

and analogously in red. (The notation  $1_{(k,l)}$  is motivated by the “dual side”, as we will see in Section 3.1. For the green–red web calculus it is just a shorthand to indicated the underlying objects.) Sometimes we draw such ladder rungs horizontally. We also have the *mixed*  $F1_{(k,l)}$ - and  $E1_{(k,l)}$ -ladders

$$(2-5) \quad F1_{(k,l)} = \begin{array}{c} k-1 \quad l+1 \\ \nearrow \quad \nearrow \\ \searrow \quad \nearrow \\ \nearrow \quad \searrow \\ k \quad l \end{array}, \quad E1_{(k,l)} = \begin{array}{c} k+1 \quad l-1 \\ \nearrow \quad \nearrow \\ \searrow \quad \nearrow \\ \nearrow \quad \searrow \\ k \quad l \end{array}$$

and similarly by exchanging green and red. Note that the ladders from (2-4) exist for all  $j \in \mathbb{Z}_{\geq 1}$ , while the mixed ladders from (2-5) exist only for  $j = 1$ .

- We usually omit the object 0 as well as edges labeled 0 from illustrations; cf (2-1).

**Definition 2.3** The *green–red web category*  $\infty\text{-Web}_{\text{gr}}$  is the quotient of  $\infty\text{-Web}_{\text{gr}}^f$  obtained by imposing the following local relations on morphisms. The *monochromatic relations*, which hold for green webs as well as for red webs: (co)associativity

$$(2-6) \quad \begin{array}{c} h+k+l \\ \nearrow \quad \nearrow \\ \searrow \quad \nearrow \\ \nearrow \quad \searrow \\ h \quad k \quad l \end{array} = \begin{array}{c} h+k+l \\ \nearrow \quad \nearrow \\ \searrow \quad \nearrow \\ \nearrow \quad \searrow \\ h \quad k \quad l \end{array}, \quad \begin{array}{c} h \quad k \quad l \\ \nearrow \quad \nearrow \\ \searrow \quad \nearrow \\ \nearrow \quad \searrow \\ h+k+l \end{array} = \begin{array}{c} h \quad k \quad l \\ \nearrow \quad \nearrow \\ \searrow \quad \nearrow \\ \nearrow \quad \searrow \\ h+k+l \end{array}$$

where we use the shorthand notation from (2-3) if some of the labels are 1. Next, the *digon removal relations*

$$(2-7) \quad \begin{array}{c} k+l \\ \nearrow \quad \nearrow \\ \searrow \quad \nearrow \\ \nearrow \quad \searrow \\ k+l \end{array} = \begin{array}{c} k+l \\ \uparrow \\ k+l \end{array} = \begin{bmatrix} k+l \\ l \end{bmatrix}$$

for which  $k$  and  $l$  might be 1. In these relations the  $(s, t)$ -quantum binomial is given by

$$\begin{bmatrix} s \\ t \end{bmatrix} = \frac{[s][s-1] \cdots [s-t+2][s-t+1]}{[t]!} \in \mathbb{C}_q.$$

Here  $[s] = (q^s - q^{-s}) / (q - q^{-1}) \in \mathbb{C}_q$  is the *quantum number* and  $[t]! = [1][2] \cdots [t] \in \mathbb{C}_q$  is the *quantum factorial* for  $s \in \mathbb{Z}$  and  $t \in \mathbb{Z}_{\geq 0}$ . Finally, the *square switch relations*

$$(2-8) \quad \begin{array}{c} k-j_1+j_2 \quad l+j_1-j_2 \\ \uparrow \quad \quad \uparrow \\ \leftarrow \quad \quad \rightarrow \\ \uparrow \quad \quad \uparrow \\ k-j_1 \quad \quad l+j_1 \\ \uparrow \quad \quad \uparrow \\ k \quad \quad \quad l \end{array} = \sum_{j' \geq 0} \begin{bmatrix} k-j_1-l+j_2 \\ j' \end{bmatrix} \begin{array}{c} k-j_1+j_2 \quad l+j_1-j_2 \\ \uparrow \quad \quad \uparrow \\ \rightarrow \quad \quad \leftarrow \\ \uparrow \quad \quad \uparrow \\ k+j_2-j' \quad \quad l-j_2+j' \\ \uparrow \quad \quad \uparrow \\ k \quad \quad \quad l \end{array}$$

Here we allow  $j_1$  or  $j_2$  to be 1 (we will get *mixed* square switch relations, with one green and one red side, in Lemma 2.10).

To write these relations in a uniform manner, we allow negative labels on edges and set webs with such edges equal to zero.

The defining relation between green and red edges is

$$(2-9) \quad \begin{array}{c} 1 \\ \uparrow \\ 1 \end{array} \begin{array}{c} 1 \\ \uparrow \\ 1 \end{array} = \begin{array}{c} 1 \quad 1 \\ \swarrow \quad \searrow \\ 2 \\ \swarrow \quad \searrow \\ 1 \quad 1 \end{array} + \begin{array}{c} 1 \quad 1 \\ \swarrow \quad \searrow \\ 2 \\ \swarrow \quad \searrow \\ 1 \quad 1 \end{array}$$

which we call the *dumbbell relation*. ◇

**Remark 2.4** The category  $\infty\text{-Web}_{\text{gr}}$  is symmetric under exchanging green and red. In the following we will often refer to this symmetry to shorten arguments.

**Definition 2.5** The category  $N\text{-Web}_{\text{gr}}$  is the quotient category obtained from the category  $\infty\text{-Web}_{\text{gr}}$  by imposing the *exterior relations*, that is,

$$(2-10) \quad \begin{array}{c} \uparrow \\ k \end{array} = 0 \quad \text{if } k > N.$$

The exterior relations hold only for green edges. These relations mean that any web  $u$  with a green edge labeled  $k > N$  is zero. In contrast, red edges labeled  $k > N$  are usually not zero.

The sorted web category  $N\text{-Web}_{\text{gr}}^{\text{sort}}$  is the full (nonmonoidal) subcategory of  $N\text{-Web}_{\text{gr}}$  whose object set consists of  $\vec{k} \in X^L$  with no red boundary point left of a green boundary point: if  $k_i \in X_r$  for some  $i$ , then  $k_{>i} \in X_b \cup X_r$ . ◇

**Remark 2.6** The relations (2-10) are diagrammatic versions of  $\bigwedge_q^{>N} \mathbb{C}_q^N \cong 0$ .

**Definition 2.7** The category  $N\text{-Web}_g$  is the subcategory of  $N\text{-Web}_{gr}$  consisting of only black and green objects and whose morphism spaces are spanned as  $\mathbb{C}_q$ -vector spaces by webs that contain only black or green edges.

Similarly, the category  $N\text{-Web}_r$  is the subcategory of  $N\text{-Web}_{gr}$  consisting of only black and red objects and whose morphism spaces are spanned as  $\mathbb{C}_q$ -vector spaces by webs that contain only black or red edges.

We call these categories *monochromatic*. ◇

**Remark 2.8** We will see in [Corollary 2.16](#) that  $N\text{-Web}_g$  is equivalent to the web category given in [\[3, Definition 2.2\]](#) (without tags and downward-pointing arrows). The category  $N\text{-Web}_r$  is a generalization of the one given in [\[25, Definition 1.4\]](#). In fact, [Proposition 2.15](#) shows that both monochromatic subcategories are full in  $N\text{-Web}_{gr}$ .

### 2.2 The diagrammatic super relations

We show in this subsection that diagrammatic versions of the relations (3-1) in the Howe dual quantum group  $\dot{U}_q(\mathfrak{gl}_m|n)$  from [Definition 3.1](#) hold in our diagrammatic categories  $\infty\text{-Web}_{gr}$  and  $N\text{-Web}_{gr}$ .

**Lemma 2.9** *We have the relations*

$$\begin{array}{c} k \\ \uparrow \text{green} \\ \text{---} \circlearrowleft \text{---} \\ \downarrow \text{red} \\ k \end{array} = 0 = \begin{array}{c} k \\ \uparrow \text{red} \\ \text{---} \circlearrowleft \text{---} \\ \downarrow \text{green} \\ k \end{array}$$

where the dots indicate  $k$  parallel black edges with label 1 which split off the bottom and merge with the top in any order (the order does not matter because of (2-6)).

**Proof** It suffices by associativity (2-6) to show the statement for  $k = 2$ . We have

$$\begin{array}{c} 2 \\ \uparrow \text{green} \\ \text{---} \circlearrowleft \text{---} \\ \downarrow \text{red} \\ 2 \end{array} \stackrel{(2-7)}{=} \frac{1}{[2]} \begin{array}{c} 2 \\ \uparrow \text{green} \\ \text{---} \circlearrowleft \text{---} \\ \uparrow \text{green} \\ \text{---} \circlearrowleft \text{---} \\ \downarrow \text{red} \\ 2 \end{array} \stackrel{(2-9)}{=} \begin{array}{c} 2 \\ \uparrow \text{green} \\ \text{---} \circlearrowleft \text{---} \\ \downarrow \text{red} \\ 2 \end{array} - \frac{1}{[2]} \begin{array}{c} 2 \\ \uparrow \text{green} \\ \text{---} \circlearrowleft \text{---} \\ \downarrow \text{red} \\ \text{---} \circlearrowleft \text{---} \\ \downarrow \text{red} \\ 2 \end{array} \stackrel{(2-7)}{=} \begin{array}{c} 2 \\ \uparrow \text{green} \\ \text{---} \circlearrowleft \text{---} \\ \downarrow \text{red} \\ 2 \end{array} - \begin{array}{c} 2 \\ \uparrow \text{green} \\ \text{---} \circlearrowleft \text{---} \\ \downarrow \text{red} \\ 2 \end{array} = 0.$$

The other  $k = 2$  relation follows by symmetry. □

**Lemma 2.10** (a) We have, for all  $k, l \in \mathbb{Z}_{\geq 0}$ ,

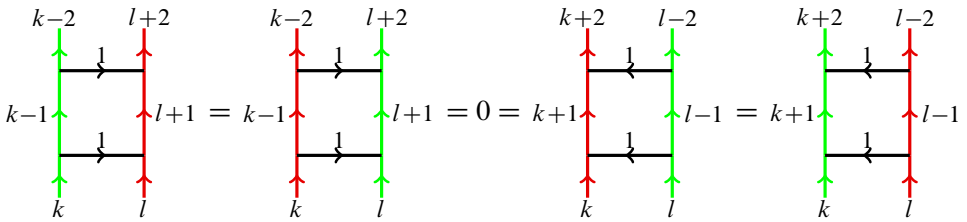

(b) We have, for all  $k, l \in \mathbb{Z}_{\geq 0}$ ,

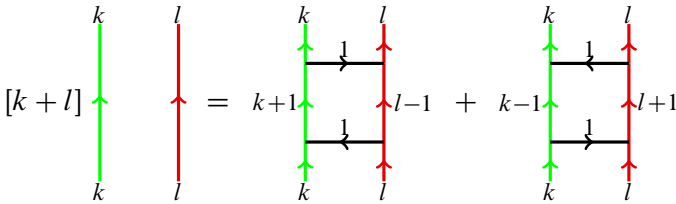

and similarly for exchanged roles of green and red.

(c) We have, for all  $k, l \in \mathbb{Z}_{\geq 0}$ ,

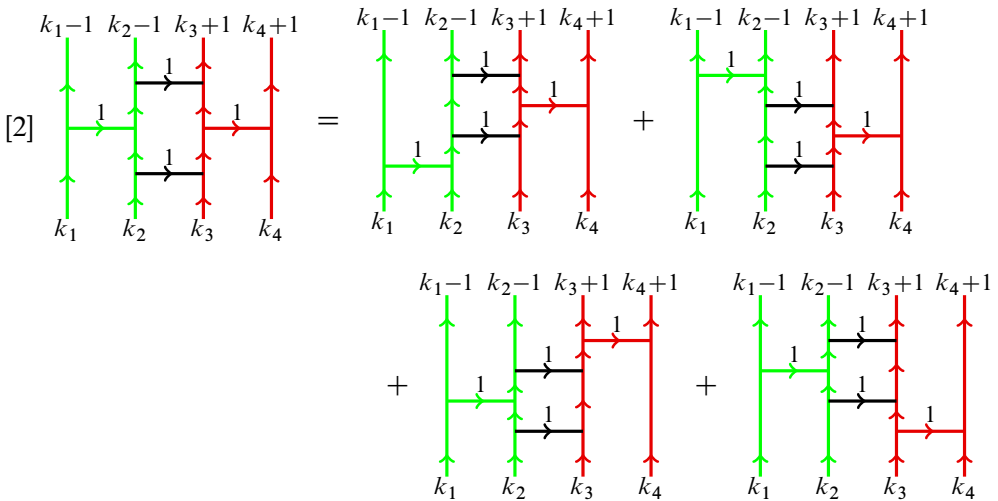

and similarly for exchanged roles of green and red, and flipped horizontal orientations.

**Proof** (a) This follows directly from (2-6), Lemma 2.9 and symmetry.

(b) Let  $u$  and  $v$  denote the two webs on the right-hand side of (b) above. Using (2-8) for the edges labeled  $k + 1$  and  $l + 1$  in  $u$ , respectively  $v$ , we get

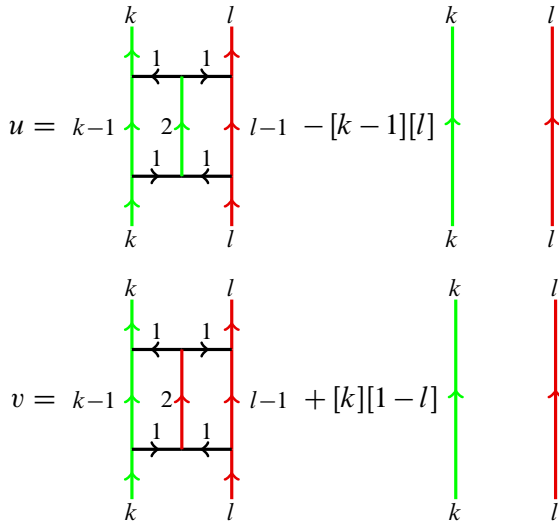

after collapsing appearing digons. By using (2-9) on the central vertical edges in the expansions, we see that  $u+v = s \cdot \text{id}_{(k,l)}$ . The scalar is  $s = [2][k][l] + [k][1-l] - [k-1][l] = [k+l]$ . The other cases follow by symmetry.

(c) We start with the web on the left-hand side and first use (2-9) on the middle two horizontal edges. Thus, we obtain (our drawings are simplified and the orientations pointing down could be isotoped to point up)

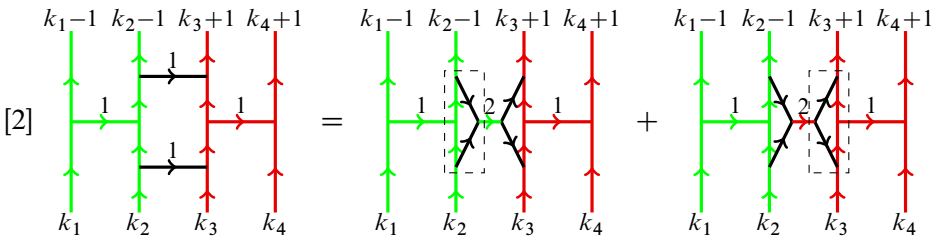

The two marked parts above are monochromatic squares, which can be switched to give

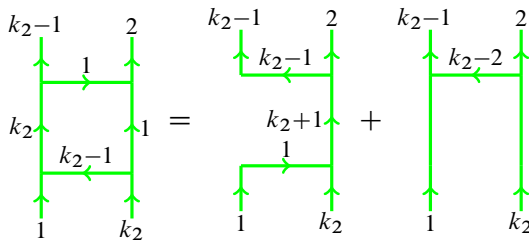

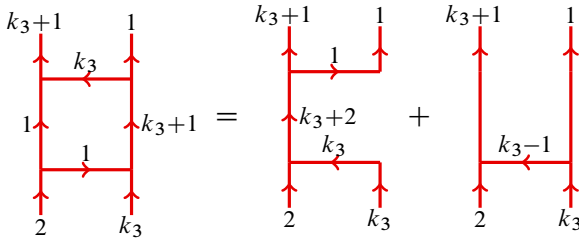

Plugging these four terms back in, we get the four webs from the right-hand side of the equation in (c) (in the indicated order), which can be seen by using (2-6), as for example

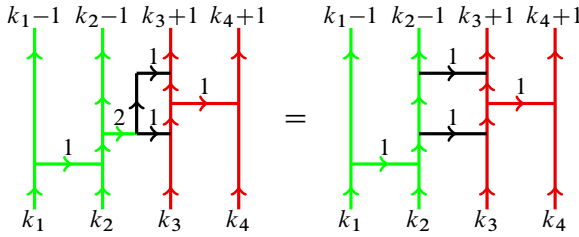

The other three cases in (c) follow by symmetry. □

### 2.3 Green and red clasps

We show now that our calculus contains web analogues of the Jones–Wenzl projectors of the Temperley–Lieb algebra. We call them *clasps*, following [15].

From now on, we denote by capital vectors such as  $\vec{K} \in X^K$  special objects of  $\infty\text{-Web}_{\text{gr}}$  of the form  $\vec{K} = (1_b, \dots, 1_b)$  with  $K$  entries equal  $1_b$  and no other entries.

**Definition 2.11** Let  $K \in \mathbb{Z}_{>0}$ . We define the  $K^{\text{th}}$  green clasp  $\mathcal{CL}_K^g \in \text{End}_{\infty\text{-Web}_{\text{gr}}}(\vec{K})$  recursively:  $\mathcal{CL}_1^g$  is the black identity strand and for  $K \in \mathbb{Z}_{>1}$  set

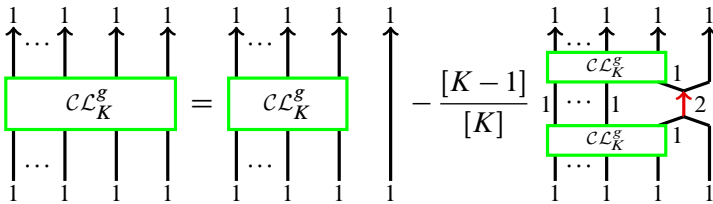

and similarly for the red clasp  $\mathcal{CL}_K^r$  by exchanging green and red. ◇

The following lemma identifies the clasps, avoiding the recursive definition.

**Lemma 2.12** We have, for all  $K \in \mathbb{Z}_{>0}$ ,

$$\mathcal{CL}_K^g = \frac{1}{[K]!} \text{ (diagram with } K \text{ green edges) }, \quad \mathcal{CL}_K^r = \frac{1}{[K]!} \text{ (diagram with } K \text{ red edges)}$$

where we repeatedly split an edge labeled  $K$  until all of the top and bottom edges are black.

**Proof** Up to signs and drawing conventions as in [25, Lemma 2.12] and left to the reader. □

**Corollary 2.13** For all  $K \in \mathbb{Z}_{>0}$ , the projector  $\mathcal{CL}_K^g$  can be expressed as a linear combination of webs with only black and red edges of label 2, and similarly for  $\mathcal{CL}_K^r$ .

**Proof** This follows directly from (2-9) and Lemma 2.12. □

**Example 2.14** The projector  $\mathcal{CL}_1^r$  is just the black identity strand, the projector  $\mathcal{CL}_2^r$  is  $1/[2]$  times the red dumbbell, as in (2-9), and

$$\begin{aligned} \mathcal{CL}_3^r = \frac{1}{[3]!} \text{ (diagram with } 3 \text{ red edges)} &= \text{ (diagram with } 3 \text{ black edges)} - \frac{[2]}{[3]} \text{ (diagram with } 2 \text{ green edges)} \\ &+ \frac{1}{[3]} \left( \text{ (diagram with } 2 \text{ green edges)} + \text{ (diagram with } 2 \text{ green edges)} \right) - \frac{1}{[2][3]} \text{ (diagram with } 2 \text{ green edges)} \end{aligned}$$

Note that all edges appearing on the right-hand side are black or green with label 2. ◁

**Proposition 2.15** Let  $\vec{k}$  and  $\vec{l}$  be sequences of black and green boundary points. Every web  $u \in \text{Hom}_{\infty\text{-Web}_{\text{gr}}}(k, l)$  can be expressed as a sum of webs with only black and green edges, and similarly by exchanging green and red.

**Proof** We start by exploding<sup>8</sup> every red edge. Around internal vertices of  $u$  with no outgoing green edges we get

<sup>8</sup>We “explode” by using (2-7)—the order does not matter by (2-6). We indicate “explosions” with dots.

$$\begin{array}{c}
 k+l \\
 \uparrow \\
 \swarrow \quad \searrow \\
 k \qquad l
 \end{array}
 = \frac{1}{[k]!} \frac{1}{[l]!} \frac{1}{[k+l]!}
 \begin{array}{c}
 k+l \\
 \uparrow \\
 \swarrow \quad \searrow \\
 k \qquad l
 \end{array}$$

Note that the marked part above is  $\mathcal{CL}_{k+l}^r$  up to a nonzero scalar. This can be seen by using (co)associativity (2-6) and the expression in Lemma 2.12. Thus, we can use Corollary 2.13 to replace  $\mathcal{CL}_{k+l}^r$  by a nonzero sum of webs with only black and green edges. Repeating this for all purely red internal vertices shows the statement, since all outer edges are assumed to be black or green. The other statement follows by symmetry.  $\square$

Denote by  $N\text{-Web}_{\text{CKM}}$  the subcategory given in [3, Definition 2.2] with only upward-pointing strands, tags replaced by (untruncated)  $N$ -labeled edges and additionally allowing 0-labeled objects. As a consequence of Proposition 2.15 we see that interpreting webs in  $N\text{-Web}_{\text{CKM}}$  as green webs in  $N\text{-Web}_{\text{gr}}$  gives a full functor  $\iota_1^\infty$  between these categories. In Lemma 3.13 we will see that it is also faithful and we get the following corollary.

**Corollary 2.16** *The functor  $\iota_1^\infty: N\text{-Web}_{\text{CKM}} \rightarrow N\text{-Web}_{\text{gr}}$ , given by coloring webs green, is an inclusion of a full, monoidal subcategory. In particular,  $N\text{-Web}_{\text{CKM}}$  and  $N\text{-Web}_{\text{g}}$  are equivalent as monoidal categories.*

**Proof** The functor is well-defined since all relations in  $N\text{-Web}_{\text{CKM}}$  hold in  $N\text{-Web}_{\text{gr}}$ . That  $\iota_1^\infty$  is monoidal is clear, fullness follows from Proposition 2.15 and faithfulness from Lemma 3.13. Thus, we see that  $N\text{-Web}_{\text{CKM}}$  and  $N\text{-Web}_{\text{g}}$  are monoidally equivalent.  $\square$

### 2.4 Braiding

We define now a *braided* monoidal structure on  $\infty\text{-Web}_{\text{gr}}$ .

**Definition 2.17** Define for  $k, l \in \mathbb{Z}_{\geq 0}$  an *elementary crossing* depending on four cases. The *monochromatic crossings* (note the different powers of  $q$ )



$$(2-11) \quad \beta_{k,l}^g = \begin{array}{c} \text{green crossing} \\ \begin{array}{c} \nearrow \\ \searrow \\ \text{green} \end{array} \\ \begin{array}{c} k \\ l \end{array} \end{array} = (-1)^{k+kl} q^k \sum_{\substack{j_1, j_2 \geq 0 \\ j_1 - j_2 = k-l}} (-q)^{-j_1} \begin{array}{c} \text{green web} \\ \begin{array}{c} \text{top: } l \quad k \\ \text{middle: } \overleftarrow{j_2} \quad \overrightarrow{j_1} \\ \text{bottom: } k \quad l \\ \text{right: } l+j_1 \end{array} \end{array}$$

$$\beta_{k,l}^r = \begin{array}{c} \text{red crossing} \\ \begin{array}{c} \nwarrow \\ \swarrow \\ \text{red} \end{array} \\ \begin{array}{c} k \\ l \end{array} \end{array} = (-1)^k q^{-k} \sum_{\substack{j_1, j_2 \geq 0 \\ j_1 - j_2 = k-l}} (-q)^{+j_1} \begin{array}{c} \text{red web} \\ \begin{array}{c} \text{top: } l \quad k \\ \text{middle: } \overrightarrow{j_2} \quad \overleftarrow{j_1} \\ \text{bottom: } k \quad l \\ \text{right: } l+j_1 \end{array} \end{array}$$

The mixed crossings are defined via explosion of the strand going over:

$$(2-12) \quad \beta_{k,l}^m = \begin{array}{c} \text{mixed crossing} \\ \begin{array}{c} \nwarrow \nearrow \\ \nearrow \nwarrow \\ \text{green} \end{array} \\ \begin{array}{c} k \\ l \end{array} \end{array} = \frac{1}{[k]!} \begin{array}{c} \text{explosion} \\ \begin{array}{c} \text{red} \quad \text{green} \\ \text{strand} \end{array} \end{array} \quad \text{and} \quad \beta_{k,l}^{\tilde{m}} = \begin{array}{c} \text{mixed crossing} \\ \begin{array}{c} \nwarrow \nearrow \\ \nwarrow \nearrow \\ \text{red} \end{array} \\ \begin{array}{c} k \\ l \end{array} \end{array} = \frac{1}{[k]!} \begin{array}{c} \text{explosion} \\ \begin{array}{c} \text{green} \quad \text{red} \\ \text{strand} \end{array} \end{array}$$

where the remaining crossings are of the form  $\beta_{1,l}^r$  or  $\beta_{1,l}^g$ , respectively.  $\diamond$

**Example 2.18** The case  $k = l = 1$  is not ambiguous, since we have

$$\beta_{1,1}^g = q \left( \begin{array}{c} \text{green crossing} \\ \begin{array}{c} \nearrow \\ \searrow \\ \text{green} \end{array} \\ \begin{array}{c} 1 \\ 1 \end{array} \end{array} - q^{-1} \begin{array}{c} \text{green crossing} \\ \begin{array}{c} \nwarrow \\ \swarrow \\ \text{green} \end{array} \\ \begin{array}{c} 2 \\ 1 \end{array} \end{array} \right) \stackrel{(2-9)}{=} -q^{-1} \left( \begin{array}{c} \text{green crossing} \\ \begin{array}{c} \nwarrow \\ \swarrow \\ \text{green} \end{array} \\ \begin{array}{c} 1 \\ 1 \end{array} \end{array} - q \begin{array}{c} \text{green crossing} \\ \begin{array}{c} \nearrow \\ \searrow \\ \text{green} \end{array} \\ \begin{array}{c} 2 \\ 1 \end{array} \end{array} \right) = \beta_{1,1}^r,$$

as a small calculation shows.  $\triangleleft$

As shorthand notation, we write  $\beta_{k,l}^\bullet$ , where  $\bullet$  stands for either  $g, r, m$  or  $\tilde{m}$  from now on. Note that the sums in (2-11) are finite, because webs with negative labels are zero.

**Lemma 2.19** (Pitchfork relations) We have

$$\begin{array}{c} \text{pitchfork relation 1} \\ \begin{array}{c} \text{green} \quad \text{red} \\ \text{strand} \end{array} \end{array} = \begin{array}{c} \text{pitchfork relation 2} \\ \begin{array}{c} \text{green} \quad \text{red} \\ \text{strand} \end{array} \end{array}, \quad \begin{array}{c} \text{pitchfork relation 3} \\ \begin{array}{c} \text{green} \quad \text{red} \\ \text{strand} \end{array} \end{array} = \begin{array}{c} \text{pitchfork relation 4} \\ \begin{array}{c} \text{green} \quad \text{red} \\ \text{strand} \end{array} \end{array}$$

and similar with exchanged roles of green and red, for the monochromatic cases and with merges.

Note that the pitchfork lemma directly implies that (2-12) could also be done by exploding the edges going underneath instead of the edges going over (or exploding both).

**Proof** The pitchfork lemma with only green colored edges follows as in Lemma 5.3 of [22]. By symmetry, the arguments go through for the monochromatic red case as well.

The mixed, left-hand equation is easy to verify by the above, since we explode the overcrossing edge and we thus can directly use the monochromatic case. It remains to prove the mixed, right-hand equation. We only need to check the case  $k = 2$ ; the case  $k \in \mathbb{Z}_{>2}$  then follows easily from this case by using Lemma 2.9. We write

$$\begin{array}{c}
 \text{Diagram 1} \\
 \text{Diagram 2} \\
 \text{Diagram 3} \\
 \text{Diagram 4}
 \end{array}
 \quad = \frac{1}{[2]} \text{Diagram 2} \stackrel{(2-9)}{=} \text{Diagram 3} - \frac{1}{[2]} \text{Diagram 4}$$

The rightmost diagram is zero by Lemma 2.9 and the monochromatic pitchfork relations. This proves the mixed right-hand equation. The other cases are analogous.  $\square$

Let  $\vec{k} \in X_{\geq 0}^L$  be an object in  $\infty\text{-Web}_{\text{gr}}$ . We define for  $i = 1, \dots, L - 1$  the crossing  $\beta_i^\bullet 1_{\vec{k}}$  to be the corresponding elementary crossing  $\beta_{k_i, k_{i+1}}^\bullet$  between the strands  $i$  and  $i + 1$  and the identity elsewhere. Clearly, it suffices to indicate the rightmost  $1_{\vec{k}}$  in a sequence of the  $\beta_i^\bullet 1_{\vec{k}}$ .

**Lemma 2.20** *The crossings  $\beta_i^\bullet 1_{\vec{k}}$  satisfy the braid relations, that is, they are invertible, they satisfy the commutation relations  $\beta_i^\bullet \beta_j^\bullet 1_{\vec{k}} = \beta_j^\bullet \beta_i^\bullet 1_{\vec{k}}$  for  $|i - j| > 2$  and the Reidemeister 3 relations  $\beta_i^\bullet \beta_j^\bullet \beta_i^\bullet 1_{\vec{k}} = \beta_j^\bullet \beta_i^\bullet \beta_j^\bullet 1_{\vec{k}}$  for  $|i - j| = 1$ .*

The inverses  $(\beta_i^\bullet)^{-1}$  are given as in (2-11), but with  $q \rightarrow q^{-1}$ . See also [22, Section 5].

**Proof** This follows from Lemma 2.19, since the black case can be verified as in [22, Section 5].  $\square$

**Remark 2.21** Let  $S_K$  denote the symmetric group on  $K$  letters. Moreover, let  $w \in S_K$  and let  $\beta_w^\bullet \in \text{End}_{\infty\text{-Web}_{\text{gr}}}(\vec{K})$  be the permutation braid associated to  $w$  (this is a well-defined assignment by Lemma 2.20). Let  $\ell(w)$  be the length of  $w$ . Following [14, Chapter 3, Section 2], one can show that

$$\mathcal{CL}_K^g = q^{\frac{K(K-1)}{2}} \frac{1}{[K]!} \sum_{w \in S_K} (-q)^{-\ell(w)} \beta_w^\bullet, \quad \mathcal{CL}_K^r = q^{-\frac{K(K-1)}{2}} \frac{1}{[K]!} \sum_{w \in S_K} q^{\ell(w)} \beta_w^\bullet.$$

The factors  $q^{\frac{K(K-1)}{2}}$  and  $q^{-\frac{K(K-1)}{2}}$  come from our conventions for crossings.

Define  $\beta_{\vec{k}, \vec{l}}^\bullet$  for objects  $\vec{k} = (k_1, \dots, k_a)$  and  $\vec{l} = (l_1, \dots, l_b)$  via

$$\beta_{\vec{k}, \vec{l}}^\bullet = \begin{array}{c} \begin{array}{ccccccc} & & l_1 & \cdots & l_b & & k_1 & \cdots & k_a \\ & & \nearrow & & \nearrow & & \nearrow & & \nearrow \\ & & & & & & & & \\ & & \nwarrow & & \nwarrow & & \nwarrow & & \nwarrow \\ k_1 & \cdots & k_a & & l_1 & \cdots & l_b \end{array} \\ \in \text{Hom}_{\infty\text{-Web}_{\text{gr}}}(\vec{k} \otimes \vec{l}, \vec{l} \otimes \vec{k}), \end{array}$$

where blue stands for all suitable color possibilities.

Recall that a *braided monoidal category* (with an underlying strict monoidal category) is a pair  $(\mathcal{C}, \beta_{\cdot, \cdot}^\bullet)$  consisting of a monoidal category  $\mathcal{C}$  and a collection of natural isomorphisms  $\beta_{\vec{k}, \vec{l}}^\bullet: \vec{k} \otimes \vec{l} \rightarrow \vec{l} \otimes \vec{k}$  such that the *hexagon identities* hold for any objects  $\vec{k}, \vec{l}, \vec{m}$  of  $\mathcal{C}$ :

$$(2-13) \quad \beta_{\vec{k}, \vec{l} \otimes \vec{m}}^\bullet = (\text{id}_{\vec{l}} \otimes \beta_{\vec{k}, \vec{m}}^\bullet) \circ (\beta_{\vec{k}, \vec{l}}^\bullet \otimes \text{id}_{\vec{m}}), \quad \beta_{\vec{k} \otimes \vec{l}, \vec{m}}^\bullet = (\beta_{\vec{k}, \vec{m}}^\bullet \otimes \text{id}_{\vec{l}}) \circ (\text{id}_{\vec{k}} \otimes \beta_{\vec{l}, \vec{m}}^\bullet).$$

**Proposition 2.22** *The pair  $(\infty\text{-Web}_{\text{gr}}, \beta_{\cdot, \cdot}^\bullet)$  is a braided monoidal category.*

**Proof** Since  $\infty\text{-Web}_{\text{gr}}$  is a monoidal category and the  $\beta_{\vec{k}, \vec{l}}^\bullet$  are isomorphisms that clearly satisfy (2-13), we only need to prove that they are natural. That is, we need to show that, for each web  $u \in \text{Hom}_{\infty\text{-Web}_{\text{gr}}}(\vec{k}, \vec{l})$  and each other object  $\vec{m} = (m_1, \dots, m_c)$  of  $\infty\text{-Web}_{\text{gr}}$ , we have (we again use blue as a generic color)

The equality follows from Lemma 2.19. This proves the statement. □

The braiding  $\beta_{\cdot, \cdot}^\bullet$  descends to the subquotients  $N\text{-Web}_{\text{gr}}$ ,  $N\text{-Web}_{\text{g}}$  and  $N\text{-Web}_{\text{r}}$  and we denote all induced braidings also by  $\beta_{\cdot, \cdot}^\bullet$ . They are all given by the formulas in Definition 2.17, but some diagrams might be zero due to (2-10).

**Corollary 2.23**  *$(N\text{-Web}_{\text{gr}}, \beta_{\cdot, \cdot}^\bullet)$ ,  $(N\text{-Web}_{\text{g}}, \beta_{\cdot, \cdot}^\bullet)$  and  $(N\text{-Web}_{\text{r}}, \beta_{\cdot, \cdot}^\bullet)$ , with the braiding  $\beta_{\cdot, \cdot}^\bullet$  induced from  $(\infty\text{-Web}_{\text{gr}}, \beta_{\cdot, \cdot}^\bullet)$ , are braided monoidal categories.* □

Note that  $N\text{-Web}_{\text{CKM}}$  is also a braided monoidal category; see [3, Corollary 6.2.3]. We rescale their braiding by multiplying it with  $q^{kl/N}$  and we denote the resulting braided monoidal category by  $(N\text{-Web}_{\text{CKM}}, \beta^{\bullet, \cdot})$ . The following corollary is immediate from Corollary 2.16.

**Corollary 2.24** *The functor  $\iota_1^\infty: (N\text{-Web}_{\text{CKM}}, \beta^{\bullet, \cdot}) \rightarrow (N\text{-Web}_{\text{gr}}, \beta^{\bullet, \cdot})$  is an inclusion of a full, braided monoidal subcategory.  $\square$*

### 2.5 A collection of diagrammatic idempotents

Recall that the *Iwahori–Hecke algebra*  $H_K(q)$  is the  $q$ -deformation of the symmetric group algebra  $\mathbb{C}[S_K]$  on  $K$  letters. It is generated by  $\{H_i \mid s_i \in S_K\}$  for all transpositions  $s_i = (i, i + 1) \in S_K$ , subject to the relations

$$\begin{aligned} H_i^2 &= (q - q^{-1})H_i + 1 && \text{for } i = 1, \dots, K - 1, \\ H_i H_j &= H_j H_i && \text{for } |i - j| > 1, \\ H_i H_j H_i &= H_j H_i H_j && \text{for } |i - j| = 1. \end{aligned}$$

There is a representation  $p_K: \mathbb{C}_q(B_K) \rightarrow H_K(q)$  of the group algebra  $\mathbb{C}_q(B_K)$  of the braid group  $B_K$  with  $K$  strands given by sending the braid group generators  $b_i$  (between the strands  $i$  and  $i + 1$ ) to  $H_i$ . Thinking of the generators  $H_i$  of  $H_K(q)$  as crossings also makes sense from the perspective of the webs, as the next lemma shows.

**Lemma 2.25** *Given  $K \in \mathbb{Z}_{\geq 0}$ , there is an isomorphism of  $\mathbb{C}_q$ -algebras*

$$\Phi_{q\text{SW}}^\infty: H_K(q) \xrightarrow{\cong} \text{End}_{\infty\text{-Web}_{\text{gr}}}(\vec{K}), \quad H_i \mapsto \begin{array}{c} \uparrow \dots \uparrow \quad \begin{array}{c} \diagup \quad \diagdown \\ \diagdown \quad \diagup \end{array} \quad \uparrow \dots \uparrow \end{array}$$

In order to prove Lemma 2.25, which will be used in Section 4, we need Theorem 3.20.

**Proof** A direct computation shows that  $\Phi_{q\text{SW}}$  is a well-defined  $\mathbb{C}_q$ -algebra homomorphism. In fact, the composite  $\Gamma \circ \Phi_{q\text{SW}}^\infty$  is the isomorphism induced by quantum Schur–Weyl duality. To see this, let  $V = (\mathbb{C}_q^N)^{\otimes K}$  and recall that quantum Schur–Weyl duality states that

$$(2-14) \quad \begin{aligned} \Phi_{q\text{SW}}^N: H_K(q) &\twoheadrightarrow \text{End}_{U_q(\mathfrak{gl}_N)}(V), \\ \Phi_{q\text{SW}}^N: H_K(q) &\xrightarrow{\cong} \text{End}_{U_q(\mathfrak{gl}_N)}(V) \quad \text{if } N \geq K. \end{aligned}$$

Here  $\Phi_{q\text{SW}}^N$  is the  $\mathbb{C}_q$ -algebra homomorphism induced by the action of  $H_K(q)$  on the  $K$ -fold tensor product  $V$ . By Theorem 3.20, we will get an isomorphism  $H_K(q) \cong$

$\text{End}_{N\text{-Web}_{\text{gr}}}(\vec{K})$  if  $N \geq K$ . By using [Proposition 2.15](#), there is a basis of  $\text{End}_{N\text{-Web}_{\text{gr}}}(\vec{K})$  for  $N \geq K$  given by webs with only black edges or green edges with labels at most  $K$ . Since  $K$  is fixed, a direct comparison shows that  $\Phi_{q\text{SW}}^\infty$  has to be an isomorphism as well.  $\square$

Let  $K \in \mathbb{Z}_{\geq 0}$  and let  $\Lambda^+(K)$  denote the set of all Young diagrams with  $K$  nodes, eg

$$\lambda = (4, 3, 1, 1) \in \Lambda^+(9) \leftrightarrow \lambda = \begin{array}{|c|c|c|c|} \hline \square & \square & \square & \square \\ \hline \square & \square & \square & \\ \hline \square & & & \\ \hline \square & & & \\ \hline \end{array},$$

$$\lambda^T = (4, 2, 2, 1) \in \Lambda^+(9) \leftrightarrow \lambda^T = \begin{array}{|c|c|c|c|} \hline \square & \square & \square & \square \\ \hline \square & \square & & \\ \hline \square & \square & & \\ \hline \square & & & \\ \hline \end{array},$$

where we use the English notation for our Young diagrams. Here we have also displayed the *transpose* Young diagram  $\lambda^T$  of  $\lambda$ . Next, the following definition is motivated by [\[11; 1\]](#). (It is best explained via examples — cf [Example 2.27](#) and [Example 2.29](#) — which the reader might want to check while reading the definition.)

**Definition 2.26** (Gyoja–Aiston idempotents) Given  $\lambda \in \Lambda^+(K)$ , we associate to it a primitive idempotent  $e_q(\lambda) \in \text{End}_{\infty\text{-Web}_{\text{gr}}}(\vec{K})$ . First we define two idempotents as tensor products of green or red clasps:

$$e_{\text{col}}(\lambda) = \mathcal{CL}_{\text{col}_1}^g \otimes \cdots \otimes \mathcal{CL}_{\text{col}_c}^g, \quad e_{\text{row}}(\lambda) = \mathcal{CL}_{\text{row}_1}^r \otimes \cdots \otimes \mathcal{CL}_{\text{row}_r}^r,$$

where  $c$  and  $r$  are the number of columns and rows of  $\lambda$  respectively, and  $\text{col}_i$  and  $\text{row}_i$  denote the number of nodes in the  $i^{\text{th}}$  column and row.

Denote by  $T_\lambda^{\rightarrow}$  and by  $T_\lambda^{\downarrow}$  the two tableaux of shape  $\lambda$  obtained by filling the numbers  $1, \dots, K$  into the Young diagram  $\lambda$  in order:  $\rightarrow$  means rows before columns and  $\downarrow$  means columns before rows (both from left to right). Pick any shortest presentation of the permutation  $w(\lambda) \in S_K$  permuting  $T_\lambda^{\rightarrow}$  to  $T_\lambda^{\downarrow}$ . Then we define the *quasi-idempotent associated to  $\lambda$*  via

$$\tilde{e}_q(\lambda) = e_{\text{col}}(\lambda) \circ \beta_{w(\lambda)}^\bullet \circ e_{\text{row}}(\lambda) \circ (\beta_{w(\lambda)}^\bullet)^{-1}.$$

By [\[1, Theorem 4.7\]](#) (and the fact that their definition agrees with ours by [Lemma 2.25](#) and [Remark 2.21](#)), there exists a nonzero scalar  $a(\lambda) \in \mathbb{C}_q$  such that  $\tilde{e}_q(\lambda)^2 = a(\lambda)\tilde{e}_q(\lambda)$ . Thus, we define the *idempotent associated to  $\lambda$*  to be

$$e_q(\lambda) = \frac{1}{a(\lambda)}\tilde{e}_q(\lambda). \quad \diamond$$

These idempotents are primitive and orthogonal by [\[11, Theorem 4.5; 1, Theorem 4.7\]](#).

**Example 2.27** If  $K = 2$ , then there are two primitive idempotents, namely

$$e_q\left(\begin{array}{|c|} \hline \square \\ \hline \square \\ \hline \end{array}\right) = \frac{1}{[2]} \begin{array}{c} \begin{array}{c} 1 \quad 1 \\ \diagdown \quad / \\ 2 \\ / \quad \diagdown \\ 1 \quad 1 \end{array} \\ \text{green} \end{array} \xrightleftharpoons[\text{red to green}]{\text{green to red}} \frac{1}{[2]} \begin{array}{c} \begin{array}{c} 1 \quad 1 \\ \diagdown \quad / \\ 2 \\ / \quad \diagdown \\ 1 \quad 1 \end{array} \\ \text{red} \end{array} = e_q\left(\begin{array}{|c|c|} \hline \square & \square \\ \hline \end{array}\right).$$

Note that  $a(\lambda) = 1$  for only one column or only one row Young diagrams  $\lambda$ . ◁

**Lemma 2.28** Exchanging green and red sends  $e_q(\lambda)$  to  $e_q(\lambda^T)$  modulo a commutator.

**Proof** Note that  $e_{\text{col}}(\lambda)$  and  $e_{\text{row}}(\lambda)$  differ from  $e_{\text{row}}(\lambda^T)$  and  $e_{\text{col}}(\lambda^T)$ , respectively, only in exchanging the colors green and red. On black crossings the green–red symmetry acts by  $\beta_{1,1}^\bullet \mapsto -(\beta_{1,1}^\bullet)^{-1}$ , on permutation braids as  $\beta_w^\bullet \mapsto (-1)^{\ell(w)}(\beta_{w^{-1}}^\bullet)^{-1}$  and on the quasi-idempotent  $\tilde{e}_q(\lambda)$  as

$$\begin{aligned} \tilde{e}_q(\lambda) &= e_{\text{col}}(\lambda) \circ \beta_{w(\lambda)}^\bullet \circ e_{\text{row}}(\lambda) \circ (\beta_{w(\lambda)}^\bullet)^{-1} \\ &\mapsto e_{\text{row}}(\lambda^T) \circ (\beta_{w(\lambda)^{-1}}^\bullet)^{-1} \circ e_{\text{col}}(\lambda^T) \circ \beta_{w(\lambda)^{-1}}^\bullet \\ &= e_{\text{row}}(\lambda^T) \circ (\beta_{w(\lambda^T)}^\bullet)^{-1} \circ e_{\text{col}}(\lambda^T) \circ \beta_{w(\lambda^T)}^\bullet. \end{aligned}$$

In the first line, the signs from the crossing inversions cancel, and in the second line we use  $w(\lambda)^{-1} = w(\lambda^T)$ . The result agrees with  $\tilde{e}_q(\lambda^T)$  up to a commutator. This proves the statement of the lemma for the quasi-idempotents. Applying the green–red symmetry to both sides of the equation  $\tilde{e}_q(\lambda)^2 = a(\lambda)\tilde{e}_q(\lambda)$  shows that  $a(\lambda) = a(\lambda^T)$  and the lemma follows. ◻

**Example 2.29** For  $\lambda = (3, 1) \in \Lambda^+(4)$ , we have

$$\lambda = \begin{array}{|c|c|c|} \hline \square & \square & \square \\ \hline \square & & \\ \hline \end{array}, \quad T_\lambda^{\rightarrow} = \begin{array}{|c|c|c|} \hline 1 & 2 & 3 \\ \hline 4 & & \\ \hline \end{array}, \quad T_\lambda^{\downarrow} = \begin{array}{|c|c|c|} \hline 1 & 3 & 4 \\ \hline 2 & & \\ \hline \end{array}.$$

Thus,  $w = (243) = (23)(34) \in S_4$  permutes  $T_\lambda^{\rightarrow}$  to  $T_\lambda^{\downarrow}$ . Then

$$\tilde{e}_q(\lambda) = \begin{array}{c} \begin{array}{c} \text{green } \mathcal{CL}_2^g \\ \beta_{w(\lambda)}^\bullet \\ \text{red } \mathcal{CL}_3^r \\ (\beta_{w(\lambda)}^\bullet)^{-1} \end{array} \\ \text{green} \leftrightarrow \text{red} \end{array} \begin{array}{c} \begin{array}{c} \text{red } \mathcal{CL}_2^r \\ (\beta_{w(\lambda)^{-1}}^\bullet)^{-1} \\ \text{green } \mathcal{CL}_3^g \\ \beta_{w(\lambda)^{-1}}^\bullet \end{array} \\ \equiv_{\text{tr}} \end{array} \begin{array}{c} \begin{array}{c} \text{green } \mathcal{CL}_3^g \\ \beta_{w(\lambda^T)}^\bullet \\ \text{red } \mathcal{CL}_2^r \\ (\beta_{w(\lambda^T)}^\bullet)^{-1} \end{array} \\ = \tilde{e}_q(\lambda^T). \end{array}$$

Here  $\equiv_{\text{tr}}$  means equal modulo a commutator and the scaling factor in this case is  $a(\lambda) = [4]/([2][3]) = a(\lambda^T)$ .  $\triangleleft$

**Remark 2.30** For  $N \geq K$ , the  $H_K(q)$ -module  $(\mathbb{C}_q^N)^{\otimes K}$  decomposes into

$$\bigoplus_{\lambda \in \Lambda^+(K)} (S^\lambda)^{\oplus m_\lambda},$$

where the  $S^\lambda$  are the irreducible *Specht modules* for  $H_K(q)$  and  $m_\lambda$  are their multiplicities. The primitive idempotents  $e_q(\lambda)$  from [Definition 2.26](#) are quantizations of Young symmetrizers that project onto  $S^\lambda$ . Note that a braid-conjugate of  $e_q(\lambda)$  might project onto a different copy of  $S^\lambda$  in the above decomposition.

### 3 Proofs of the diagrammatic presentations

This section contains the proof of our main theorems.

#### 3.1 Super $q$ -Howe duality

Let  $m, n \in \mathbb{Z}_{\geq 0}$ . We start by recalling the *quantum general linear superalgebra*  $U_q(\mathfrak{gl}_{m|n})$  and its *idempotent form*  $\check{U}_q(\mathfrak{gl}_{m|n})$ . We follow the conventions used in [\[33\]](#), but adapt Zhang’s notation to be closer to the one from [\[3\]](#).

To this end, recall that the  $\mathfrak{gl}_{m|n}$ -weight lattice is isomorphic to  $\mathbb{Z}^{m+n}$  and we denote the  $\mathfrak{gl}_{m|n}$ -weights usually by vectors  $\vec{k} = (k_1, \dots, k_m, k_{m+1}, \dots, k_{m+n})$ . For  $\mathbb{I} = \mathbb{I}_0 \cup \mathbb{I}_1$  with  $\mathbb{I}_0 = \{1, \dots, m\}$  (even part) and  $\mathbb{I}_1 = \{m + 1, \dots, m + n\}$  (odd part), define

$$|i| = \begin{cases} 0 & \text{if } i \in \mathbb{I}_0 = \{1, \dots, m\}, \\ 1 & \text{if } i \in \mathbb{I}_1 = \{m + 1, \dots, m + n\}. \end{cases}$$

The notation  $|\cdot|$  means the *super degree* (which is a  $\mathbb{Z}/2$ -degree). We use a similar notation for all  $\mathbb{Z}/2$ -graded spaces, where we, by convention, always consider degrees modulo 2 in the following. Moreover, let  $\epsilon_i = (0, \dots, 0, 1, 0, \dots, 0) \in \mathbb{Z}^{m+n}$ , with 1 being in the  $i^{\text{th}}$  coordinate, and denote by  $\alpha_i = \epsilon_i - \epsilon_{i+1} = (0, \dots, 1, -1, \dots, 0) \in \mathbb{Z}^{m+n}$  for  $i \in \mathbb{I} - \{m + n\}$  the  $i^{\text{th}}$  simple root. Recall that the *super Euclidean inner product* on  $\mathbb{Z}^{m+n}$  is given by  $(\epsilon_i, \epsilon_j)_{\text{su}} = (-1)^{|i|} \delta_{i,j}$ .

**Definition 3.1** Let  $m, n \in \mathbb{Z}_{\geq 0}$ . The *quantum general linear superalgebra*  $U_q(\mathfrak{gl}_{m|n})$  is the associative,  $\mathbb{Z}/2$ -graded, unital  $\mathbb{C}_q$ -algebra generated by  $L_i^{\pm 1}$  for  $i \in \mathbb{I}$ , and  $F_i$  and  $E_i$  for  $i \in \mathbb{I} - \{m + n\}$ , subject to the *nonsuper* relations

$$\begin{aligned} L_i L_j &= L_j L_i, & L_i L_i^{-1} &= L_i^{-1} L_i = 1, \\ L_i F_j &= q^{-(\epsilon_i, \alpha_j)_{\text{su}}} F_j L_i, & L_i E_j &= q^{(\epsilon_i, \alpha_j)_{\text{su}}} E_j L_i, \end{aligned}$$

$$\begin{aligned}
 E_i F_j - F_j E_i &= (-1)^{|i|} \delta_{i,j} \frac{L_i L_{i+1}^{-1} - L_i^{-1} L_{i+1}}{q - q^{-1}} \quad \text{if } i \neq m, \\
 [2] F_i F_j F_i &= F_i^2 F_j + F_j F_i^2 \quad \text{if } |i - j| = 1, i \neq m, \\
 [2] E_i E_j E_i &= E_i^2 E_j + E_j E_i^2 \quad \text{if } |i - j| = 1, i \neq m, \\
 F_i F_j - F_j F_i &= 0 \quad \text{if } |i - j| > 1, \\
 E_i E_j - E_j E_i &= 0 \quad \text{if } |i - j| > 1
 \end{aligned}$$

(for suitable  $i, j \in \mathbb{I}$ ) and the super relations

$$F_m^2 = 0 = E_m^2, \quad E_m F_m + F_m E_m = \frac{L_m L_{m+1}^{-1} - L_m^{-1} L_{m+1}}{q - q^{-1}},$$

$$\begin{aligned}
 [2] F_m F_{m+1} F_{m-1} F_m &= \\
 F_m F_{m+1} F_m F_{m-1} + F_{m-1} F_m F_{m+1} F_m + F_{m+1} F_m F_{m-1} F_m + F_m F_{m-1} F_m F_{m+1}, \\
 [2] E_m E_{m+1} E_{m-1} E_m &= \\
 E_m E_{m+1} E_m E_{m-1} + E_{m-1} E_m E_{m+1} E_m + E_{m+1} E_m E_{m-1} E_m + E_m E_{m-1} E_m E_{m+1}.
 \end{aligned}$$

Also,  $|L_i| = 0$  for  $i \in \mathbb{I}$ ,  $|F_i| = |E_i| = 0$  for  $i \in \mathbb{I} - \{m\}$  and  $|F_m| = |E_m| = 1$ .  $\diamond$

We recover  $U_q(\mathfrak{gl}_N)$  by setting  $m = N$  and  $n = 0$ . We write  $\mathbb{I}_N = \{1, \dots, N\}$  in the following to distinguish it from  $\mathbb{I}$  as above. Note that  $U_q(\mathfrak{gl}_N)$  is concentrated in degree 0.

The algebra  $U_q(\mathfrak{gl}_{m|n})$  is a  $\mathbb{Z}/2$ -graded Hopf algebra with coproduct  $\Delta$ , antipode  $S$  and the counit  $\varepsilon$  given by

$$\begin{aligned}
 \Delta(F_i) &= F_i \otimes 1 + L_i^{-1} L_{i+1} \otimes F_i, \quad \Delta(E_i) = E_i \otimes L_i L_{i+1}^{-1} + 1 \otimes E_i, \quad \Delta(L_i) = L_i \otimes L_i, \\
 S(F_i) &= -L_i L_{i+1}^{-1} F_i, \quad S(E_i) = -E_i L_i^{-1} L_{i+1}, \quad S(L_i) = L_i^{-1}, \\
 \varepsilon(F_i) &= \varepsilon(E_i) = 0, \quad \varepsilon(L_i) = 1.
 \end{aligned}$$

In the spirit of Lusztig [20, Chapter 23], we now adjoin, for all  $\vec{k} \in \mathbb{Z}^{m+n}$ , idempotents  $1_{\vec{k}}$  of super degree  $|1_{\vec{k}}| = 0$  to  $U_q(\mathfrak{gl}_{m|n})$ . Denote by  $I$  the ideal generated by

$$\begin{aligned}
 1_{\vec{k}} 1_{\vec{l}} &= \delta_{\vec{k}, \vec{l}} 1_{\vec{k}}, & 1_{\vec{k}-\alpha_i} F_i 1_{\vec{k}} &= F_i 1_{\vec{k}} = 1_{\vec{k}-\alpha_i} F_i, \\
 L_i 1_{\vec{k}} &= q^{k_i(\epsilon_i, \epsilon_i)_{\text{su}}} 1_{\vec{k}}, & 1_{\vec{k}+\alpha_i} E_i 1_{\vec{k}} &= E_i 1_{\vec{k}} = 1_{\vec{k}+\alpha_i} E_i.
 \end{aligned}$$

**Definition 3.2** Define by

$$\dot{U}_q(\mathfrak{gl}_{m|n}) = \left( \bigoplus_{\vec{k}, \vec{l} \in \mathbb{Z}^{m+n}} 1_{\vec{l}} U_q(\mathfrak{gl}_{m|n}) 1_{\vec{k}} \right) / I$$

the idempotent quantum general linear superalgebra.  $\diamond$



**Remark 3.3** One can view  $\dot{U}_q(\mathfrak{gl}_{m|n})$  as generated by the *divided powers*

$$F_i^{(j)} = \frac{F_i^j}{[j]!} \quad \text{and} \quad E_i^{(j)} = \frac{E_i^j}{[j]!} \quad \text{for } i \in \mathbb{I} - \{m+n\}.$$

This allows the definition of an integral version of  $\dot{U}_q(\mathfrak{gl}_{m|n})$ . For simplicity, we work over  $\mathbb{C}_q$  in this paper and we do not consider the integral version.

The relations in  $\dot{U}_q(\mathfrak{gl}_{m|n})$  are obtained from the relations of  $U_q(\mathfrak{gl}_{m|n})$ . For convenience we list the new versions of the *super* relations:

$$(3-1) \quad \begin{aligned} F_m^2 1_{\vec{k}} &= 0 = E_m^2 1_{\vec{k}}, \\ E_m F_m 1_{\vec{k}} + F_m E_m 1_{\vec{k}} &= [k_m + k_{m+1}] 1_{\vec{k}}, \\ [2] F_m F_{m+1} F_{m-1} F_m 1_{\vec{k}} &= F_m F_{m+1} F_m F_{m-1} 1_{\vec{k}} + F_{m-1} F_m F_{m+1} F_m 1_{\vec{k}} \\ &\quad + F_{m+1} F_m F_{m-1} F_m 1_{\vec{k}} + F_m F_{m-1} F_m F_{m+1} 1_{\vec{k}}, \end{aligned}$$

the second of which we call the *super commutation relation* (the third type of relation holds for  $E$  as well).

It is convenient for us hereinafter to view  $\dot{U}_q(\mathfrak{gl}_{m|n})$  as a category whose objects are the  $\mathfrak{gl}_{m|n}$ -weights  $\vec{k} \in \mathbb{Z}^{m+n}$  and  $\text{Hom}_{\dot{U}_q(\mathfrak{gl}_{m|n})}(k, \vec{l}) = 1_{\vec{l}} \dot{U}_q(\mathfrak{gl}_{m|n}) 1_{\vec{k}}$ .

Recall that the vector representation  $\mathbb{C}_q^{m|n}$  of  $U_q(\mathfrak{gl}_{m|n})$  has a basis given by  $\{x_i \mid i \in \mathbb{I}\}$  with super degrees  $|x_i| = |i|$  for  $i \in \mathbb{I}$ , where the  $U_q(\mathfrak{gl}_{m|n})$ -action is defined via

$$\begin{aligned} F_i(x_j) &= \begin{cases} x_{j+1} & \text{if } i = j, \\ 0 & \text{otherwise,} \end{cases} & E_i(x_j) &= \begin{cases} x_{j-1} & \text{if } i = j - 1, \\ 0, & \text{otherwise,} \end{cases} \\ L_i(x_j) &= q^{(\epsilon_i, \epsilon_j)_{\text{su}}} x_j. \end{aligned}$$

We need to consider the *quantum exterior superalgebra*  $\bigwedge_q^\bullet(\mathbb{C}_q^{m|n} \otimes \mathbb{C}_q^N)$ . Recall that a vector space  $V = V_0 \oplus V_1$  with a  $\mathbb{Z}/2$ -grading is called a *super* vector space. Here  $V_0$  and  $V_1$  are its degree 0 and 1 parts. These graded parts of  $\mathbb{C}_q^{m|n}$  have bases given by  $\{x_i \mid i \in \mathbb{I}_0\}$  and  $\{x_i \mid i \in \mathbb{I}_1\}$ , respectively. In contrast,  $\mathbb{C}_q^N = (\mathbb{C}_q^N)_0$  is concentrated in degree zero and we denote its basis by  $\{y_j \mid j \in \mathbb{I}_N\}$ . Additionally, the tensor product  $V \otimes W$  of two super vector spaces  $V$  and  $W$  is a super vector space with  $v \otimes w$  of degree  $|v| + |w|$  for two homogeneous elements  $v$  and  $w$ . Specifically,  $\mathbb{C}_q^{m|n} \otimes \mathbb{C}_q^N$  is a super vector space with  $(\mathbb{C}_q^{m|n} \otimes \mathbb{C}_q^N)_0$  spanned by  $\{z_{ij} = x_i \otimes y_j \mid i \in \mathbb{I}_0, j \in \mathbb{I}_N\}$  and  $(\mathbb{C}_q^{m|n} \otimes \mathbb{C}_q^N)_1$  spanned by  $\{z_{ij} = x_i \otimes y_j \mid i \in \mathbb{I}_1, j \in \mathbb{I}_N\}$ . Here  $|z_{ij}| = |i|$ . Note that  $(\mathbb{C}_q^{m|n} \otimes \mathbb{C}_q^N)^{\otimes K}$  is a  $\mathbb{Z}/2$ -graded  $U_q(\mathfrak{gl}_{m|n}) \otimes U_q(\mathfrak{gl}_N)$ -module for all  $K \in \mathbb{Z}_{\geq 0}$  by using the Hopf algebras structures of  $U_q(\mathfrak{gl}_{m|n})$  and  $U_q(\mathfrak{gl}_N)$ .

We denote by  $\text{Sym}_q^2(\mathbb{C}_q^{m|n} \otimes \mathbb{C}_q^N)$  the *second symmetric super power* as in [23, (4.1)], but with  $q$  inverted in their formulas. Armed with this notation, we define the *quantum exterior superalgebra*

$$\bigwedge_q^\bullet(\mathbb{C}_q^{m|n} \otimes \mathbb{C}_q^N) = T(\mathbb{C}_q^{m|n} \otimes \mathbb{C}_q^N) / \text{Sym}_q^2(\mathbb{C}_q^{m|n} \otimes \mathbb{C}_q^N),$$

where  $T(\mathbb{C}_q^{m|n} \otimes \mathbb{C}_q^N) = \bigoplus_{K \in \mathbb{Z}_{\geq 0}} (\mathbb{C}_q^{m|n} \otimes \mathbb{C}_q^N)^{\otimes K}$  denotes the *super tensor algebra* of  $\mathbb{C}_q^{m|n} \otimes \mathbb{C}_q^N$ . This is a  $U_q(\mathfrak{gl}_{m|n}) \otimes U_q(\mathfrak{gl}_N)$ -module and decompose as

$$\bigwedge_q^\bullet(\mathbb{C}_q^{m|n} \otimes \mathbb{C}_q^N) \cong \bigoplus_{K \in \mathbb{Z}_{\geq 0}} \bigwedge_q^K(\mathbb{C}_q^{m|n} \otimes \mathbb{C}_q^N).$$

The space  $\bigwedge_q^K(\mathbb{C}_q^{m|n} \otimes \mathbb{C}_q^N)$  is called the *degree  $K$  part* of  $\bigwedge_q^\bullet(\mathbb{C}_q^{m|n} \otimes \mathbb{C}_q^N)$ .

**Remark 3.4** We can recover the degree  $K$  part of the quantum exterior algebra  $\bigwedge_q^K(\mathbb{C}_q^m \otimes \mathbb{C}_q^N)$  by setting  $n = 0$  and, by [28, Remark 2.1], the degree  $K$  part of the quantum symmetric algebra  $\text{Sym}_q^K(\mathbb{C}_q^n \otimes \mathbb{C}_q^N)$  by setting  $m = 0$ . These were originally defined in [2, Definition 2.7] and used in [3, Section 4.2; 25, Section 2.1] to study skew and symmetric  $q$ -Howe duality.

**Example 3.5** Write  $z_{\vec{i}\vec{j}} = z_{i_1 j_1} \otimes \cdots \otimes z_{i_K j_K}$  and  $z_{i_k j_k} \preceq z_{i_{k+1} j_{k+1}}$  for the anti-lexicographical order on the indices of the  $z_{ij}$ . Then  $\bigwedge_q^K(\mathbb{C}_q^{m|n} \otimes \mathbb{C}_q^N)$  has a basis given by (cf [23, Lemma 4.1])

$$(3-2) \quad \{z_{\vec{i}\vec{j}} \mid z_{i_k j_k} \preceq z_{i_{k+1} j_{k+1}}, 1 \leq i_1 \leq \cdots \leq i_K \leq m+n, 1 \leq j_1 \leq \cdots \leq j_K \leq N, \text{ and } |i_k| = 1, \text{ if } i_k = i_{k+1} \text{ and } j_k = j_{k+1}\}.$$

By setting  $m = 1$  and  $n = 0$ , we obtain the (usual) basis for  $\bigwedge_q^K \mathbb{C}_q^N$  of the form

$$(3-3) \quad \{y_{i_1} \otimes \cdots \otimes y_{i_K} \mid 1 \leq y_1 < \cdots < y_K \leq N\},$$

while setting  $m = 0$  and  $n = 1$  gives the (usual) basis for  $\text{Sym}_q^K \mathbb{C}_q^N$  of the form

$$(3-4) \quad \{y_{i_1} \otimes \cdots \otimes y_{i_K} \mid 1 \leq y_1 \leq \cdots \leq y_K \leq N\}.$$

These are precisely the usual (nonsuper) bases; see for example [2, Section 2.4]. ◁

We call a  $\mathfrak{gl}_{m|n}$ -weight  $\lambda = (\lambda_1, \dots, \lambda_{m+n}) \in \mathbb{Z}^{m+n}$  a *dominant integral  $\mathfrak{gl}_{m|n}$ -weight* if it is a dominant integral  $\mathfrak{gl}_m \oplus \mathfrak{gl}_n$ -weight. We only need  $\lambda$  that are  $(m|n)$ -hook Young diagrams, ie diagrams that fit into a hook-shaped region with one horizontal arm of height  $m$  and one vertical arm of width  $n$  (here we use the conventions from [4, Definition 2.10]). The following figure shows an  $(m|n)$ -hook Young diagram  $\lambda$  and a box-shaped Young diagram that is not an  $(m|n)$ -hook:

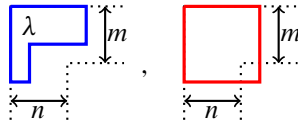

We call a dominant integral  $\mathfrak{gl}_{m|n}$ -weight  $\lambda$  an  $(m|n, N)$ -supported  $\mathfrak{gl}_{m|n}$ -weight if it corresponds to an  $(m|n)$ -hook Young diagram with at most  $N$  columns. For each such  $\lambda$  there exists an irreducible  $U_q(\mathfrak{gl}_{m|n})$ -module  $L_{m|n}(\lambda)$  and an irreducible  $U_q(\mathfrak{gl}_N)$ -module  $L_N(\lambda^T)$ ; see eg [16, Section 2.5].

**Theorem 3.6** (Super  $q$ -Howe duality) *We have the following:*

- (a) Let  $K \in \mathbb{Z}_{\geq 0}$ . The actions of  $U_q(\mathfrak{gl}_{m|n})$  and  $U_q(\mathfrak{gl}_N)$  on  $\bigwedge_q^K(\mathbb{C}_q^{m|n} \otimes \mathbb{C}_q^N)$  commute and generate each others commutant.
- (b) There exists an isomorphism

$$\bigwedge_q(\mathbb{C}_q^{m|n} \otimes \mathbb{C}_q^N) \cong (\bigwedge_q \mathbb{C}_q^N)^{\otimes m} \otimes (\text{Sym}_q \mathbb{C}_q^N)^{\otimes n}$$

of  $U_q(\mathfrak{gl}_N)$ -modules under which the  $\vec{k}$ -weight space of  $\bigwedge_q(\mathbb{C}_q^{m|n} \otimes \mathbb{C}_q^N)$  (considered as a  $U_q(\mathfrak{gl}_{m|n})$ -module) is identified with

$$(3-5) \quad \bigwedge_q^{\vec{k}_0} \mathbb{C}_q^N \otimes \text{Sym}_q^{\vec{k}_1} \mathbb{C}_q^N = \bigwedge_q^{k_1} \mathbb{C}_q^N \otimes \dots \otimes \bigwedge_q^{k_m} \mathbb{C}_q^N \otimes \text{Sym}_q^{k_{m+1}} \mathbb{C}_q^N \otimes \dots \otimes \text{Sym}_q^{k_{m+n}} \mathbb{C}_q^N.$$

Here  $\vec{k} = (k_1, \dots, k_{m+n})$ ,  $\vec{k}_0 = (k_1, \dots, k_m)$  and  $\vec{k}_1 = (k_{m+1}, \dots, k_{m+n})$ .

- (c) As  $U_q(\mathfrak{gl}_{m|n}) \otimes U_q(\mathfrak{gl}_N)$ -modules, we have a decomposition of the form

$$\bigwedge_q^K(\mathbb{C}_q^{m|n} \otimes \mathbb{C}_q^N) \cong \bigoplus_{\lambda} L_{m|n}(\lambda) \otimes L_N(\lambda^T),$$

where we sum over all  $(m|n, N)$ -supported  $\mathfrak{gl}_{m|n}$ -weights  $\lambda$  whose entries sum up to  $K$ . This induces a decomposition

$$\bigwedge_q(\mathbb{C}_q^{m|n} \otimes \mathbb{C}_q^N) \cong \bigoplus_{\lambda} L_{m|n}(\lambda) \otimes L_N(\lambda^T),$$

where we sum over all  $(m|n, N)$ -supported  $\mathfrak{gl}_{m|n}$ -weights  $\lambda$ .

**Remark 3.7** Symmetric and skew Howe duality for the pair  $(\text{GL}_m, \text{GL}_N)$  is originally due to Howe; see [12, Sections 2 and 4]. Note that the nonquantum version of Theorem 3.6 can be found for example in [4, Theorem 3.3] or [28, Proposition 2.2]. Moreover, the “dual” of Theorem 3.6, given by considering  $U_q(\mathfrak{gl}_N)$  as the Howe dual group instead of  $U_q(\mathfrak{gl}_{m|n})$ , can be found in [23, Proposition 4.3].

**Proof** Parts (a) and (c) are proven in [31, Theorem 2.2] or in [23, Theorem 4.2] and only (b) remains to be verified. For this purpose, we use the bases from (3-2), (3-3) and (3-4) to define

$$T_i^e: \wedge_q^k(\mathbb{C}_q^N) \rightarrow \wedge_q^k(\mathbb{C}_q^{m|n} \otimes \mathbb{C}_q^N), \quad y_{j_1} \otimes \cdots \otimes y_{j_k} \mapsto z_{ij_1} \otimes \cdots \otimes z_{ij_k}, \quad i \in \mathbb{I}_0,$$

$$T_i^s: \text{Sym}_q^k(\mathbb{C}_q^N) \rightarrow \wedge_q^k(\mathbb{C}_q^{m|n} \otimes \mathbb{C}_q^N), \quad y_{j_1} \otimes \cdots \otimes y_{j_k} \mapsto z_{ij_1} \otimes \cdots \otimes z_{ij_k}, \quad i \in \mathbb{I}_1.$$

That these maps are well-defined  $U_q(\mathfrak{gl}_N)$ -intertwiners follows from the explicit description in Example 3.5. Injectivity was shown in [3, Theorem 4.2.2] for the first and in [25, Theorem 2.6] for the second map. Thus, for  $\vec{k} \in \mathbb{Z}^{m+n}$  with  $k_1 + \cdots + k_{m+n} = K$ , we see that

$$T: \bigoplus_{\vec{k} \in \mathbb{Z}_{\geq 0}^{m+n}} \wedge_q^{\vec{k}_0} \mathbb{C}_q^N \otimes \text{Sym}_q^{\vec{k}_1} \mathbb{C}_q^N \rightarrow \wedge_q^K(\mathbb{C}_q^{m|n} \otimes \mathbb{C}_q^N)$$

given by

$$T(v_1 \otimes \cdots \otimes v_{m+n}) = T_1^e(v_1) \otimes \cdots \otimes T_m^e(v_m) \otimes T_{m+1}^s(v_{m+1}) \otimes \cdots \otimes T_{m+n}^s(v_{m+n})$$

is a  $U_q(\mathfrak{gl}_N)$ -module isomorphism by comparing the sizes of the bases from Example 3.5. This clearly induces the isomorphism of  $U_q(\mathfrak{gl}_N)$ -modules we are looking for.

It remains to verify the  $U_q(\mathfrak{gl}_{m|n})$ -weight space decomposition from (3-5). To this end, we only have to see that the action on  $\wedge_q^{\vec{k}_0} \mathbb{C}_q^N \otimes \text{Sym}_q^{\vec{k}_1} \mathbb{C}_q^N$  of the  $L_{i'}$  of  $U_q(\mathfrak{gl}_{m|n})$  under the inverse of  $T$  is just a multiplication with  $q^{k_i(\epsilon_i, \epsilon_{i'})_{\text{su}}}$ . The action of  $U_q(\mathfrak{gl}_{m|n})$  is given by

$$L_{i'}(z_{ij_1} \otimes \cdots \otimes z_{ij_{m+n}}) = L_{i'}(z_{ij_1}) \otimes \cdots \otimes L_{i'}(z_{ij_{m+n}}) = q^{k_i(\epsilon_i, \epsilon_{i'})_{\text{su}}} z_{ij_1} \otimes \cdots \otimes z_{ij_{m+n}}.$$

Hence, the  $U_q(\mathfrak{gl}_{m|n})$ -weight space decomposition follows. □

By Theorem 3.6(b), we get linear maps

$$f_{\vec{k}}^{\vec{l}}: 1_{\vec{l}} \dot{U}_q(\mathfrak{gl}_{m|n}) 1_{\vec{k}} \rightarrow \text{Hom}_{U_q(\mathfrak{gl}_N)}(\wedge_q^{\vec{k}_0} \mathbb{C}_q^N \otimes \text{Sym}_q^{\vec{k}_1} \mathbb{C}_q^N, \wedge_q^{\vec{l}_0} \mathbb{C}_q^N \otimes \text{Sym}_q^{\vec{l}_1} \mathbb{C}_q^N)$$

for any two  $\vec{k}, \vec{l} \in \mathbb{Z}_{\geq 0}^{m+n}$  such that  $\sum_{i=0}^{m+n} k_i = \sum_{i=0}^{m+n} l_i$ . Using Theorem 3.6(a), we see that the homomorphisms  $f_{\vec{k}}^{\vec{l}}$  are all surjective. Thus, we get the following.

**Corollary 3.8** *There exists a full functor  $\Phi_{\text{su}}^{m|n}: \dot{U}_q(\mathfrak{gl}_{m|n}) \rightarrow \mathfrak{gl}_N\text{-Mod}_{\text{es}}$ , which we call the super  $q$ -Howe functor, given on objects and morphisms by*

$$\Phi_{\text{su}}^{m|n}(\vec{k}) = \wedge_q^{\vec{k}_0} \mathbb{C}_q^N \otimes \text{Sym}_q^{\vec{k}_1} \mathbb{C}_q^N, \quad \Phi_{\text{su}}^{m|n}(1_{\vec{l}} x 1_{\vec{k}}) = f_{\vec{k}}^{\vec{l}}(x).$$

Everything else is sent to zero. □

### 3.2 The sorted equivalences

In this subsection we construct a full and faithful functor

$$\Gamma_N^{\text{sort}}: N\text{-Web}_{\text{gr}}^{\text{sort}} \rightarrow \mathfrak{gl}_N\text{-Mod}_{\text{es}}^{\text{sort}},$$

where  $N\text{-Web}_{\text{gr}}^{\text{sort}}$  is the sorted web category from Definition 2.5 and  $\mathfrak{gl}_N\text{-Mod}_{\text{es}}^{\text{sort}}$  denotes the full subcategory of  $\mathfrak{gl}_N\text{-Mod}_{\text{es}}$  whose objects are sorted as in (3-5).

As already explained in the introduction, we essentially define  $\Gamma_N^{\text{sort}}$  such that there is a commuting diagram:

$$(3-6) \quad \begin{array}{ccc} \dot{U}_q(\mathfrak{gl}_{m|n}) & \xrightarrow{\Phi_{\text{su}}^{m|n}} & \mathfrak{gl}_N\text{-Mod}_{\text{es}}^{\text{sort}} \\ & \searrow \Upsilon_{\text{su}}^{m|n} & \uparrow \Gamma_N^{\text{sort}} \\ & & N\text{-Web}_{\text{gr}}^{\text{sort}} \end{array}$$

The functor  $\Upsilon_{\text{su}}^{m|n}$  is a ladder functor, whose definition is motivated by [3, Section 5.1].

**Lemma 3.9** *Let  $m, n \in \mathbb{Z}_{\geq 0}$ . There exists a functor*

$$\Upsilon_{\text{su}}^{m|n}: \dot{U}_q(\mathfrak{gl}_{m|n}) \rightarrow N\text{-Web}_{\text{gr}}^{\text{sort}}$$

which sends a  $\mathfrak{gl}_{m|n}$ -weight  $\vec{k} \in \mathbb{Z}_{\geq 0}^{m+n}$  to  $((k_1)_g, \dots, (k_m)_g, (k_{m+1})_r, \dots, (k_{m+n})_r)$  in  $N\text{-Web}_{\text{gr}}^{\text{sort}}$  and all other  $\mathfrak{gl}_{m|n}$ -weights to the zero object. On morphisms,  $\Upsilon_{\text{su}}^{m|n}$  is given by

$$\begin{array}{l} F_i^{(j)} 1_{\vec{k}} \mapsto \begin{array}{cccccc} k_1 & & k_{i-j} & k_{i+1+j} & k_m & k_{m+1} & k_{m+n} \\ \uparrow & \cdots & \uparrow & \xrightarrow{j} & \uparrow & \cdots & \uparrow \\ k_1 & & k_i & & k_{i+1} & & k_{m+1} & k_{m+n} \end{array} \\ \\ F_i^{(j)} 1_{\vec{k}} \mapsto \begin{array}{cccccc} k_1 & k_m & k_{m+1} & k_{i-j} & k_{i+1+j} & k_{m+n} \\ \uparrow & \cdots & \uparrow & \cdots & \uparrow & \xrightarrow{j} & \uparrow & \cdots & \uparrow \\ k_1 & & k_m & & k_{m+1} & & k_i & & k_{i+1} & k_{m+n} \end{array} \end{array}$$

for  $i \in \mathbb{I}_0 - \{m\}$  or  $i \in \mathbb{I}_1 - \{m+n\}$ , respectively, and

$$F_m 1_{\vec{k}} \mapsto \begin{array}{cccccc} k_1 & k_{m-1} & k_{m-1} & k_{m+1+1} & k_{m+2} & k_{m+n} \\ \uparrow & \cdots & \uparrow & \xrightarrow{1} & \uparrow & \cdots & \uparrow \\ k_1 & & k_{m-1} & & k_m & & k_{m+1} & k_{m+2} & k_{m+n} \end{array}$$

and similarly, but with reversed horizontal orientations, for the generators  $E_i^{(j)} 1_{\vec{k}}$  and  $E_m 1_{\vec{k}}$ .

**Proof** To show that  $\Upsilon_{\text{su}}^{m|n}$  is well-defined, it suffices to show that all relations in  $\dot{U}_q(\mathfrak{gl}_m|n)$  are satisfied in  $N\text{-Web}_{\text{gr}}^{\text{sort}}$ . For monochromatic relations we can copy [3, Proposition 5.2.1]. **Lemma 2.10** shows that the super relations (3-1) hold in  $N\text{-Web}_{\text{gr}}^{\text{sort}}$ .  $\square$

**Definition 3.10** (The diagrammatic presentation functor  $\Gamma_N^{\text{sort}}$ ) We define a functor  $\Gamma_N^{\text{sort}}: N\text{-Web}_{\text{gr}}^{\text{sort}} \rightarrow \mathfrak{gl}_N\text{-Mod}_{\text{es}}^{\text{sort}}$  as follows:

- On objects: to each  $\vec{k} = ((k_1)_g, \dots, (k_m)_g, (k_{m+1})_r, \dots, (k_{m+n})_r)$ , we assign

$$\Gamma_N^{\text{sort}}(\vec{k}) = \bigwedge_q^{\vec{k}_0} \mathbb{C}_q^N \otimes \text{Sym}_q^{\vec{k}_1} \mathbb{C}_q^N,$$

where  $\vec{k}_0 = (k_1, \dots, k_m)$  and  $\vec{k}_1 = (k_{m+1}, \dots, k_{m+n})$ . Moreover, we send the empty tuple to the trivial  $U_q(\mathfrak{gl}_N)$ -module  $\mathbb{C}_q$  and the zero object to the  $U_q(\mathfrak{gl}_N)$ -module 0.

- On morphisms: we use the functor  $\Phi_{\text{su}}^{m|n}$  from **Corollary 3.8** to define  $\Gamma_N^{\text{sort}}$  on the generating trivalent vertices in  $N\text{-Web}_{\text{gr}}^{\text{sort}}$  (here we assume that the diagrams are the identities outside of the illustrated part). For this, let  $i \in \mathbb{I}$  and we use the notation  $k = k_i, l = k_{i+1}$  and  $(k, l) = (k_1, \dots, k_i = k, k_{i+1} = l, \dots, k_{m+n})$ .

$$(3-7) \quad \begin{aligned} \Gamma_N^{\text{sort}} \left( \begin{array}{c} k+l \\ \text{green merge} \\ k \quad l \end{array} \right) &= \Phi_{\text{su}}^{m|n}(E_i^{(l)} 1_{(k,l)}), & \Gamma_N^{\text{sort}} \left( \begin{array}{c} k \quad l \\ \text{green split} \\ k+l \end{array} \right) &= \Phi_{\text{su}}^{m|n}(F_i^{(l)} 1_{(k+l,0)}), \\ \Gamma_N^{\text{sort}} \left( \begin{array}{c} k+l \\ \text{red merge} \\ k \quad l \end{array} \right) &= \Phi_{\text{su}}^{m|n}(F_i^{(k)} 1_{(k,l)}), & \Gamma_N^{\text{sort}} \left( \begin{array}{c} k \quad l \\ \text{red split} \\ k+l \end{array} \right) &= \Phi_{\text{su}}^{m|n}(E_i^{(k)} 1_{(0,k+l)}). \end{aligned}$$

Note that these definitions include the mixed case, where we either have  $l = 1$  (and colored black) or  $k = 1$  (and colored black) and we use the odd generators  $F_m$  and  $E_m$ .  $\diamond$

**Remark 3.11** There are certain choices for the images of monochromatic merges and splits, but these choices do not matter; see [25, Remark 2.18]. In contrast, there is no other choice for the mixed merges and splits. For example, take  $l = 1$  in the top left in (3-7). The green edge labeled  $k + 1$  should represent  $\bigwedge_q^{k+1} \mathbb{C}_q^N$ . Thus, we have to see the top boundary of the left-hand side as  $1_{(k+1,0)}$  and not as  $1_{(0,k+1)}$ , which determines our choices, and similarly for the other mixed generators. For example, if  $m = n = 1$ , and  $k = 1$  or  $l = 1$ , then

$$\Gamma_N^{\text{sort}} \left( \begin{array}{c} 2 \\ \uparrow \\ \text{---} \\ \swarrow \quad \searrow \\ 1 \quad 1 \end{array} \right) = \Phi_{\text{su}}^{1|1}(E_1 1_{(1,1)}) \neq \Phi_{\text{su}}^{1|1}(F_1 1_{(1,1)}) = \Gamma_N^{\text{sort}} \left( \begin{array}{c} 2 \\ \uparrow \\ \text{---} \\ \swarrow \quad \searrow \\ 1 \quad 1 \end{array} \right).$$

**Lemma 3.12**  $\Gamma_N^{\text{sort}}$  is a well-defined functor  $\Gamma_N^{\text{sort}}: N\text{-Web}_{\text{gr}}^{\text{sort}} \rightarrow \mathfrak{gl}_N\text{-Mod}_{\text{es}}^{\text{sort}}$  making the diagram (3-6) commutative.

**Proof** First we note that  $\Gamma_N^{\text{sort}} \circ \Upsilon_{\text{su}}^{m|n} = \Phi_{\text{su}}^{m|n}$  on generators  $F_i^{(j)} 1_{\vec{k}}$  and  $F_m 1_{\vec{k}}$  (and analogously for  $E$ ) with  $i \in \mathbb{I} - \{m\}$ ,  $j \in \mathbb{Z}_{\geq 0}$  and  $\vec{k} \in \mathbb{Z}^{m+n}$ . This follows from the definition of  $\Gamma_N^{\text{sort}}$  via  $\Phi_{\text{su}}^{m|n}$  and the observation that ladders can be written as compositions of merges and splits; see also [25, Lemma 2.20].

We need to check that the images of the relations from  $N\text{-Web}_{\text{gr}}^{\text{sort}}$  under  $\Gamma_N^{\text{sort}}$  hold in  $\mathfrak{gl}_N\text{-Mod}_{\text{es}}^{\text{sort}}$ . Corollary 3.8 guarantees that all relations in  $\mathfrak{gl}_N\text{-Mod}_{\text{es}}^{\text{sort}}$  are induced via  $\Phi_{\text{su}}^{m|n}$  from relations in  $\dot{U}_q(\mathfrak{gl}_{m|n})$  and the fact that  $\Phi_{\text{su}}^{m|n}$  kills certain  $\mathfrak{gl}_{m|n}$ -weights. It remains to check that the relations in  $N\text{-Web}_{\text{gr}}^{\text{sort}}$  are, likewise, induced via  $\Upsilon_{\text{su}}^{m|n}$  from relations in  $\dot{U}_q(\mathfrak{gl}_{m|n})$ . For the monochromatic and isotopy relations, this follows as in [25, Lemma 2.20].

The dumbbell relation (2-9) can be recovered from  $\dot{U}_q(\mathfrak{gl}_{m|n})$  as follows. Without loss of generality we work with  $m = n = 1$ :

$$[2] \begin{array}{c} | \\ | \\ | \\ | \\ | \\ | \end{array} = \Upsilon_{\text{su}}^{1|1}([2] 1_{(1,1)}) = \Upsilon_{\text{su}}^{1|1}(FE 1_{(1,1)} + EF 1_{(1,1)}) = \begin{array}{c} 1 \quad 1 \\ \swarrow \quad \searrow \\ 2 \\ \swarrow \quad \searrow \\ 1 \quad 1 \end{array} + \begin{array}{c} 1 \quad 1 \\ \swarrow \quad \searrow \\ 2 \\ \swarrow \quad \searrow \\ 1 \quad 1 \end{array}$$

Relation (2-10) is a consequence of killing  $\mathfrak{gl}_{m|n}$ -weights  $\vec{k} = (k_1, \dots, k_{m+n})$ , one of whose first  $m$  entries is larger than  $N$ . □

**Lemma 3.13** The functor  $\iota_1^\infty: N\text{-Web}_{\text{CKM}} \rightarrow N\text{-Web}_{\text{gr}}$  is faithful.

**Proof** By Lemma 3.12 and a comparison of definitions, we have a commuting diagram

$$\begin{array}{ccc} \mathfrak{gl}_N\text{-Mod}_e & \xrightarrow{\iota_e^{\text{es}}} & \mathfrak{gl}_N\text{-Mod}_{\text{es}}^{\text{sort}} \\ \Gamma_{\text{CKM}} \uparrow & & \uparrow \Gamma_N^{\text{sort}} \\ N\text{-Web}_{\text{CKM}} & \xrightarrow{\iota_1^\infty} & N\text{-Web}_{\text{gr}}^{\text{sort}} \end{array}$$

where  $\Gamma_{\text{CKM}}$  is the functor considered in [3, Section 3.2] and  $\iota_e^{\text{es}}$  is the evident embedding of a full subcategory.  $\Gamma_{\text{CKM}}$  is faithful by [3, Theorem 3.3.1] and, thus,  $\iota_1^\infty$  is faithful as well.  $\square$

**Remark 3.14** Let  $\mathbf{Mat}(N\text{-Web}_{\text{gr}}^{\text{sort}})$  be the additive closure of  $N\text{-Web}_{\text{gr}}^{\text{sort}}$ : objects are finite, formal direct sums of the objects of  $N\text{-Web}_{\text{gr}}^{\text{sort}}$  and morphisms are matrices (whose entries are morphisms from  $N\text{-Web}_{\text{gr}}^{\text{sort}}$ ). We can extend  $\Gamma_N^{\text{sort}}$  additively to a functor

$$\Gamma_N^{\text{sort}}: \mathbf{Mat}(N\text{-Web}_{\text{gr}}^{\text{sort}}) \rightarrow \mathfrak{gl}_N\text{-Mod}_{\text{es}}^{\text{sort}},$$

and similarly for  $\Gamma_N$  later on.

**Proposition 3.15** The functor  $\Gamma_N^{\text{sort}}: N\text{-Web}_{\text{gr}}^{\text{sort}} \rightarrow \mathfrak{gl}_N\text{-Mod}_{\text{es}}^{\text{sort}}$  gives rise to an equivalence of categories  $\Gamma_N^{\text{sort}}: \mathbf{Mat}(N\text{-Web}_{\text{gr}}^{\text{sort}}) \rightarrow \mathfrak{gl}_N\text{-Mod}_{\text{es}}^{\text{sort}}$ .

**Proof** Since  $\Gamma_N^{\text{sort}}: \mathbf{Mat}(N\text{-Web}_{\text{gr}}^{\text{sort}}) \rightarrow \mathfrak{gl}_N\text{-Mod}_{\text{es}}^{\text{sort}}$  is well-defined by Lemma 3.12 and Remark 3.14, it remains to show that  $\Gamma_N^{\text{sort}}$  is essentially surjective, full and faithful.

**Essentially surjective** This follows directly from the definitions of  $\Gamma_N^{\text{sort}}$ ,  $N\text{-Web}_{\text{gr}}^{\text{sort}}$ , its additive closure  $\mathbf{Mat}(N\text{-Web}_{\text{gr}}^{\text{sort}})$  and  $\mathfrak{gl}_N\text{-Mod}_{\text{es}}^{\text{sort}}$ .

**Full** It suffices to verify fullness for morphisms between objects of the form  $\vec{k} \in X^{m+n}$ , where  $X^{m+n} = (X_b \cup X_g)^m \cup (X_b \cup X_r)^n$ . That it holds is clear from diagram (3-6), since  $\Phi_{\text{su}}^{m|n}$  is full by Corollary 3.8.

**Faithful** Again it suffices to verify faithfulness for morphisms between objects of the form  $\vec{k} \in X^{m+n}$ . Given any web  $u \in \text{Hom}_{N\text{-Web}_{\text{gr}}^{\text{sort}}}(\vec{k}, \vec{l})$  for  $\vec{k} \in X^{m+n}$  and  $\vec{l} \in X^{m'+n'}$ , we can compose  $u$  from the bottom and the top with merges and splits, respectively, to obtain

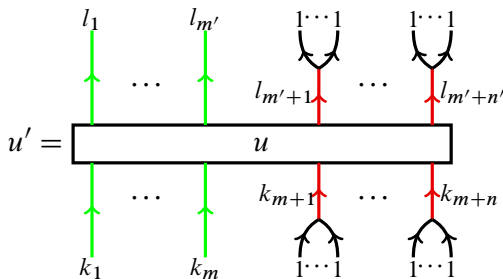

Recall that exploding edges is, by (2-7), a reversible operation. Hence, we have

$$\Gamma_N^{\text{sort}}(u) = \Gamma_N^{\text{sort}}(v) \quad \text{if and only if} \quad \Gamma_N^{\text{sort}}(u') = \Gamma_N^{\text{sort}}(v'),$$



which together with [Corollary 2.16](#) reduces the verification of faithfulness to the case where all web edges are black or green. Such webs lie in  $\iota_1^\infty(N\text{-Web}_{\text{CKM}})$  and faithfulness follows as in the proof of [Lemma 3.13](#).  $\square$

### 3.3 Proofs of the equivalences

**Remark 3.16** Recall that the *universal  $R$ -matrix* for  $\mathfrak{gl}_N$  gives a braiding on the category  $\mathfrak{gl}_N\text{-Mod}_{\text{es}}$  as follows (see eg [\[29, Chapter XI, Sections 2 and 7\]](#)). For any pair of  $U_q(\mathfrak{gl}_N)$ -modules  $V$  and  $W$  in  $\mathfrak{gl}_N\text{-Mod}_{\text{es}}$ , let  $\text{Perm}_{V,W}: V \otimes W \rightarrow W \otimes V$  be the permutation  $\text{Perm}_{V,W}(v \otimes w) = w \otimes v$  and define  $\beta_{V,W}^R = \text{Perm}_{V,W} \circ R$ . We scale  $\beta_{V,W}^R$  as

$$\tilde{\beta}_{V,W}^R = q^{-\frac{kl}{N}} \beta_{V,W}^R$$

whenever  $V$  and  $W$  are exterior or symmetric power  $U_q(\mathfrak{gl}_N)$ -modules of exponent  $k$  and  $l$ , respectively. This induces a scaling  $\tilde{\beta}_{V,W}^R$  of  $\beta_{V,W}^R$  for all  $U_q(\mathfrak{gl}_N)$ -modules  $V, W \in \mathfrak{gl}_N\text{-Mod}_{\text{es}}$ . Then  $(\mathfrak{gl}_N\text{-Mod}_{\text{es}}, \tilde{\beta}_{\cdot,\cdot}^R)$  is a braided monoidal category.

The goal of this subsection is to finally prove our main theorems. To this end, we extend [\(3-6\)](#) to a diagram

$$(3-8) \quad \begin{array}{ccccc} \dot{U}_q(\mathfrak{gl}_{m|n}) & \xrightarrow{\Phi_{\text{su}}^{m|n}} & \mathfrak{gl}_N\text{-Mod}_{\text{es}}^{\text{sort}} & \hookrightarrow & \mathfrak{gl}_N\text{-Mod}_{\text{es}} \\ & \searrow \Upsilon_{\text{su}}^{m|n} & \uparrow \Gamma_N^{\text{sort}} & & \uparrow \Gamma_N \\ & & N\text{-Web}_{\text{gr}}^{\text{sort}} & \hookrightarrow & N\text{-Web}_{\text{gr}} \\ & & & \xrightarrow{\iota_{\text{dia}}} & \end{array}$$

where  $\iota_{\text{alg}}$  and  $\iota_{\text{dia}}$  are the evident inclusions of full subcategories. We will define the functor  $\Gamma_N$  such that the diagram [\(3-8\)](#) commutes.

**Definition 3.17** (The diagrammatic presentation functor  $\Gamma_N$ ) We define a functor  $\Gamma_N: N\text{-Web}_{\text{gr}} \rightarrow \mathfrak{gl}_N\text{-Mod}_{\text{es}}$  as follows:

- On objects,  $\Gamma_N$  sends an object  $\vec{k} \in X^L$  of  $N\text{-Web}_{\text{gr}}$  to the tensor product of exterior and symmetric powers of  $\mathbb{C}_q^N$  specified by the entries of  $\vec{k}$ ; green and red integers encode exterior and symmetric powers respectively, and a black entry 1 corresponds to  $\mathbb{C}_q^N$  itself.
- On morphisms, for an object  $\vec{k} \in X^L$  let  $w(\vec{k}) \in S_L$  be a shortest length permutation that sorts green integers in  $\vec{k}$  to the left of red integers. We define  $\Gamma_N$  on an arbitrary web  $u \in \text{Hom}_{N\text{-Web}_{\text{gr}}}(\vec{k}, \vec{l})$  by precomposing and postcomposing with elementary crossings and the universal  $R$ -matrix intertwiners:

$$\Gamma_N(u) = (\tilde{\beta}_{w(\vec{l})}^R)^{-1} \circ \Gamma_N^{\text{sort}}(\beta_{w(\vec{l})}^\bullet) \circ u \circ (\beta_{w(\vec{k})}^\bullet)^{-1} \circ \tilde{\beta}_{w(\vec{k})}^R.$$

Clearly,  $\Gamma_N$  restricts to  $\Gamma_N^{\text{sort}}$ .  $\diamond$

**Lemma 3.18**  $\Gamma_N: N\text{-Web}_{\text{gr}} \rightarrow \mathfrak{gl}_N\text{-Mod}_{\text{es}}$  is a monoidal functor making (3-8) commutative.

**Proof** By Lemma 3.12 and the fact that  $\beta_{\cdot, \cdot}^\bullet$  and  $\tilde{\beta}_{\cdot, \cdot}^R$  are braidings (see Proposition 2.22 and Remark 3.16), we see that  $\Gamma_N$  is well-defined. That  $\Gamma_N$  is monoidal and makes (3-8) commutative is clear from its construction.  $\square$

**Proposition 3.19** The functor  $\Gamma_N: (N\text{-Web}_{\text{gr}}, \beta_{\cdot, \cdot}^\bullet) \rightarrow (\mathfrak{gl}_N\text{-Mod}_{\text{es}}, \tilde{\beta}_{\cdot, \cdot}^R)$  is a functor of braided monoidal categories.

**Proof** By Lemma 3.18, it remains to verify

$$\Gamma_N(\beta_{\vec{k} \otimes \vec{l}}^\bullet) = \tilde{\beta}_{\Gamma_N(\vec{k}), \Gamma_N(\vec{l})}^R \quad \text{for all objects } \vec{k} \text{ and } \vec{l} \text{ of } N\text{-Web}_{\text{gr}}.$$

The green–red symmetry and the fact that the mixed crossings are defined via the monochromatic crossings, together with Corollary 2.24, reduce this problem to the situation studied in [3, Theorem 6.2.1 and Lemma 6.2.2]. It remains to show

$$\Gamma_N(\beta_{1,1}^g) = \Gamma_N(\beta_{1,1}^r) = \Gamma_N^{\text{sort}}(\beta_{1,1}^g) = \Gamma_N^{\text{sort}}(\beta_{1,1}^r) = \tilde{\beta}_{\mathbb{C}_q^N, \mathbb{C}_q^N}^R.$$

This follows since  $\Gamma_N^{\text{sort}}(\beta_{1,1}^g) = \Gamma_N^{\text{sort}}(\beta_{1,1}^r)$  acts on

$$\mathbb{C}_q^N \otimes \mathbb{C}_q^N \cong \wedge_q^2(\mathbb{C}_q^N) \oplus \text{Sym}_q^2(\mathbb{C}_q^N)$$

as  $-q^{-1}$  on the first summand and as  $q$  on the second (see Example 2.18).  $\square$

**Theorem 3.20** (The diagrammatic presentations) The functor

$$\Gamma_N: (\mathbf{Mat}(N\text{-Web}_{\text{gr}}), \beta_{\cdot, \cdot}^\bullet) \rightarrow (\mathfrak{gl}_N\text{-Mod}_{\text{es}}, \tilde{\beta}_{\cdot, \cdot}^R)$$

is an equivalence of braided monoidal categories.

**Proof** By Proposition 3.19,  $\Gamma_N$  extends to a braided monoidal functor on the additive closure and it remains to show that  $\Gamma_N$  is essentially surjective, full and faithful.

**Essentially surjective** This follows directly from the definitions; see also Remark 3.14.

**Full and faithful** As before, it suffices to verify this on morphisms between objects of the form  $\vec{k} \in X^L$ . Consider the commuting diagram

$$\begin{array}{ccc} \mathfrak{gl}_N\text{-Mod}_{\text{es}}^{\text{sort}} & \xleftarrow{\omega_R} & \mathfrak{gl}_N\text{-Mod}_{\text{es}} \\ \Gamma_N^{\text{sort}} \uparrow & & \uparrow \Gamma_N \\ N\text{-Web}_{\text{gr}}^{\text{sort}} & \xleftarrow{\omega_\bullet} & N\text{-Web}_{\text{gr}} \end{array}$$

where  $\omega_R$  and  $\omega_\bullet$  are the functors that order  $f \in \text{Hom}_{\mathfrak{gl}_N\text{-Mod}_{\text{es}}}(\Gamma_N(\vec{k}), \Gamma_N(\vec{l}))$  and webs  $u \in \text{Hom}_{N\text{-Web}_{\text{gr}}}(\vec{k}, \vec{l})$  by using the  $R$ -matrix braiding  $\tilde{\beta}_{\cdot, \cdot}^R$  and the braiding  $\beta_{\cdot, \cdot}^\bullet$ , respectively, via a permutation of shortest length. Since sorting is invertible, we get

$$\begin{aligned} \dim(\text{Hom}_{\mathfrak{gl}_N\text{-Mod}_{\text{es}}}(\Gamma_N(\vec{k}), \Gamma_N(\vec{l}))) &= \dim(\text{Hom}_{\mathfrak{gl}_N\text{-Mod}_{\text{es}}^{\text{sort}}}(\Gamma_N^{\text{sort}}(\omega_\bullet(\vec{k})), \Gamma_N^{\text{sort}}(\omega_\bullet(\vec{l})))) \\ &= \dim(\text{Hom}_{N\text{-Web}_{\text{gr}}^{\text{sort}}}(\omega_\bullet(\vec{k}), \omega_\bullet(\vec{l}))) \\ &= \dim(\text{Hom}_{N\text{-Web}_{\text{gr}}}(\vec{k}, \vec{l})), \end{aligned}$$

where the second equality follows from Proposition 3.15. □

**Remark 3.21** For now we restrict ourselves to working with webs with only upward-oriented edges. Downward-oriented edges, as for example in [3], can be used to represent the duals of the  $U_q(\mathfrak{gl}_N)$ -modules  $\bigwedge_q^k \mathbb{C}_q^N$  and  $\text{Sym}_q^l \mathbb{C}_q^N$ . With respect to such an enriched web calculus, the statement of Theorem 3.20 extends to an equivalence of pivotal categories; see [23, Section 6] and Remark 5.12.

Let  $\check{H}$  denotes the monoidal,  $\mathbb{C}_q$ -linear category obtained from the collection  $H_\infty(q)$  of Iwahori–Hecke algebras as follows. The objects  $e$  and  $e'$  of  $\check{H}$  are tensor products of Iwahori–Hecke algebra idempotents corresponding to  $e_{\text{col}}(\lambda)$  and  $e_{\text{row}}(\lambda)$  (as in Definition 2.26) under the isomorphism in Lemma 2.25. The morphism spaces are given by  $\text{Hom}_{\check{H}}(e, e') = e' H_\infty(q) e$ . The category  $\check{H}$  is braided with braiding  $\tilde{\beta}_{\cdot, \cdot}^H$  induced from  $H_\infty(q)$ .

**Theorem 3.22** (The diagrammatic presentation) *For large  $N$  the functors  $\Gamma_N$  stabilize to a functor*

$$\Gamma_\infty: (\text{Mat}(\infty\text{-Web}_{\text{gr}}), \beta_{\cdot, \cdot}^\bullet) \rightarrow (\text{Mat}(\check{H}), \tilde{\beta}_{\cdot, \cdot}^H),$$

which is an equivalence of braided monoidal categories.

**Proof** By Schur–Weyl duality (2-14) and by the construction of the categories  $N\text{-Web}_{\text{gr}}$  as quotients of  $\infty\text{-Web}_{\text{gr}}$ , we have quotient functors  $\pi_\infty^N$  and  $\pi^N$  for  $N \in \mathbb{Z}_{\geq 0}$  such that

$$(3-9) \quad \begin{array}{ccc} \text{Mat}(\check{H}) & \xrightarrow{\pi^N} & \mathfrak{gl}_N\text{-Mod}_{\text{es}} \\ \Gamma_\infty \uparrow & & \uparrow \Gamma_N \\ \text{Mat}(\infty\text{-Web}_{\text{gr}}) & \xrightarrow{\pi_\infty^N} & \text{Mat}(N\text{-Web}_{\text{gr}}) \end{array}$$

commutes. Here the functor  $\Gamma_\infty$  is an idempotent version of the inverse of the isomorphism  $\Phi_{q\text{SW}}^\infty$  from Lemma 2.25.

Fix two objects  $\vec{k} \in X^L$  and  $\vec{l} \in X^L$  of  $\infty\text{-Web}_{\text{gr}}$  and suppose that  $N$  is greater than the sum of the integer values of the entries of  $\vec{k}$  (ignoring their colors). Then, by (2-14), Theorem 3.20, the commutativity of (3-9) and the fullness of  $\pi_\infty^N$ , we have

$$\begin{aligned} \dim(\text{Hom}_{\check{H}}(\Gamma_\infty(\vec{k}), \Gamma_\infty(\vec{l}))) &= \dim(\text{Hom}_{\text{gl}_N\text{-Mod}_{\text{es}}}(\pi^N(\Gamma_\infty(\vec{k})), \pi^N(\Gamma_\infty(\vec{l})))) \\ &= \dim(\text{Hom}_{N\text{-Web}_{\text{gr}}}(\pi_\infty^N(\vec{k}), \pi_\infty^N(\vec{l}))) \\ &= \dim(\text{Hom}_{\infty\text{-Web}_{\text{gr}}}(\vec{k}, \vec{l})). \end{aligned}$$

$\Gamma_\infty$  is clearly essentially surjective and a braided monoidal functor, and the theorem follows. □

### 4 Applications

In this section we write  $\mathcal{L}_D$  for diagrams of framed, oriented links  $\mathcal{L}$ ,  $b_D^K$  for diagrams of braids in  $K$  strands and  $\bar{b}_D^K$  for closures of such braid diagrams. We consider labelings of the connected components of  $\mathcal{L}$  and of braids by Young diagrams  $\lambda^i$ . If  $\mathcal{L}$  is a  $d$ -component link, then we write  $\mathcal{L}(\vec{\lambda})$  for its labeling by a vector of Young diagrams  $\vec{\lambda} = (\lambda^1, \dots, \lambda^d)$ , and use an analogous notation for labeled link and braid diagrams. If not mentioned otherwise, then all appearing links and related concepts are assumed to be framed and oriented from now on.

Let  $\mathcal{L}_D(\vec{\lambda}) = \bar{b}_D^K(\vec{\lambda})$  be a diagram of a framed, oriented, labeled link given as a braid closure. The following process associates to  $b_D^K(\vec{\lambda})$  an element  $p_{K'}(\bar{b}_D^{K'})e_q(\vec{\lambda})$  of  $H_{K'}(q) \cong \text{End}_{\infty\text{-Web}_{\text{gr}}}(K')$ :

$$\lambda^i \uparrow \xrightarrow{\text{cable}} \begin{array}{c} \uparrow \uparrow \cdots \uparrow \uparrow \\ K_i \text{ strands} \end{array} \xrightarrow{p_{K_i}(\cdot)} p_{K_i} \left( \begin{array}{c} \uparrow \uparrow \cdots \uparrow \uparrow \\ K_i \text{ strands} \end{array} \right) e_q(\lambda^i) = \begin{array}{c} \uparrow \uparrow \cdots \uparrow \uparrow \\ \boxed{e_q(\lambda^i)} \\ \downarrow \downarrow \cdots \downarrow \downarrow \\ \text{I I} \end{array}$$

where the last equality follows from Lemma 2.25 and we write  $p_{K_i}$  for the Iwahori–Hecke algebra representation of the braid group on  $K_i$  strands. The first step replaces strands labeled by a Young diagram  $\lambda^i$  with  $K_i$  nodes in the braid diagram  $b_D^K$  by  $K_i$  parallel strands. This results in a new braid  $\bar{b}_D^{K'}$ , where  $K'$  indicates the number of strands. In the second step this cabled braid is interpreted as an element of the Iwahori–Hecke algebra, or, equivalently, as a web in  $\infty\text{-Web}_{\text{gr}}$ , with an idempotent  $e_q(\lambda^i)$  placed on the cable of each previously  $\lambda^i$  labeled strand.

#### 4.1 The colored HOMFLY–PT polynomial via $\infty\text{-Web}_{\text{gr}}$

In this subsection we work over the ground field  $\mathbb{C}_{a,q} = \mathbb{C}_q(a)$ , with  $a$  being a generic parameter. We will use the  $\mathbb{C}_{a,q}$ -valued Jones–Ocneanu trace  $\text{tr}(\cdot)$  on the direct sum

of all Iwahori–Hecke algebras  $H_\infty(q) = \bigoplus_{K \in \mathbb{Z}_{\geq 0}} H_K(q)$ . The definition of  $\text{tr}(\cdot)$  can be found in [13, Section 5] (which can be easily adapted to our notation). We will use it in the form of the following lemma.

**Lemma 4.1** Given a web  $u \in \text{End}_{\infty\text{-Web}_{\text{gr}}}(\vec{K})$ ,

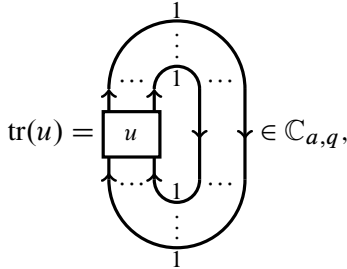

where the closed diagram can be evaluated by using the relations in  $\infty\text{-Web}_{\text{gr}}$  and, additionally,

$$(4-1) \quad \text{Diagram 1} = \frac{a - a^{-1}}{q - q^{-1}}, \quad \text{Diagram 2} = \frac{aq^{-1} - a^{-1}q}{q - q^{-1}} \text{Diagram 3}$$

**Proof** By Proposition 2.15 and Corollary 2.13: any given web  $u \in \text{End}_{\infty\text{-Web}_{\text{gr}}}(\vec{K})$  can be expressed using black or green edges with labels at most 2. Using Lemma 2.25 and additionally [24, Section 4.2], where Rasmussen’s singular crossings correspond to green dumbbells with label 2, provides the statement. Note that Rasmussen’s relations II and III are already part of our diagrammatic calculus.  $\square$

**Definition 4.2** (The colored HOMFLY–PT polynomial) Let  $\mathcal{L}_D(\vec{\lambda}) = \bar{b}_D^K(\vec{\lambda})$  be a diagram of a framed, oriented, labeled link  $\mathcal{L}(\vec{\lambda})$  given as a braid closure.

The colored HOMFLY–PT polynomial of  $\mathcal{L}(\vec{\lambda})$ , denoted by  $\mathcal{P}^{a,q}(\mathcal{L}(\vec{\lambda}))$ , is defined via

$$\mathcal{P}^{a,q}(\mathcal{L}(\vec{\lambda})) = \text{tr}(p_{K'}(\tilde{b}_D^{K'})e_q(\vec{\lambda})) \in \mathbb{C}_{a,q},$$

where  $e_q(\vec{\lambda})$  is a tensor product of the  $e_q(\lambda^i)$ , as described above.  $\diamond$

This polynomial is independent of all choices involved and an invariant of framed, oriented, colored links. Up to different conventions, this is shown for example in [17, Corollary 4.5].

**Remark 4.3** In fact, Definition 4.2 gives the framing dependent, unnormalized version of the colored HOMFLY–PT polynomial. As usual, the polynomial can be normalized by fixing the value of the unknot to be 1 (instead of  $(a - a^{-1})/(q - q^{-1})$  as in our convention) and one can get rid of the framing dependence by scaling with a factor coming from Reidemeister 1 moves; see for example [13, Definition 6.1]. We suppress these distinctions in the following.

Note that Lemma 4.1 provides a method to calculate the colored HOMFLY–PT polynomials  $\mathcal{P}^{a,q}(\cdot)$  using the web category  $\infty\text{-Web}_{\text{gr}}$ .

**Proposition 4.4** (The colored HOMFLY–PT symmetry) *We have*

$$\mathcal{P}^{a,q}(\mathcal{L}(\vec{\lambda})) = (-1)^c \mathcal{P}^{a,q^{-1}}(\mathcal{L}(\vec{\lambda}^T)),$$

where  $\vec{\lambda}^T = ((\lambda^1)^T, \dots, (\lambda^d)^T)$  and  $c$  is the sum of the number of nodes in the  $\lambda^i$  for  $1 \leq i \leq d$ .

This symmetry is not new: it can be deduced from [19, Section 9] and has been studied in [18; 6, Proposition 4.4]. In our framework it follows directly from the green–red symmetry in  $\infty\text{-Web}_{\text{gr}}$ .

**Proof** We only give a proof for the case of knots  $\mathcal{K}$ . The proof for links is analogous, but the notation is more involved. We denote by  $I_{\text{gr}}$  the involution on  $\infty\text{-Web}_{\text{gr}}$  given by the green–red symmetry, and by  $I_q$  the involution on  $\mathbb{C}_{a,q}$  which inverts the variable  $q$ .

**Claim** For  $u \in \text{End}_{\infty\text{-Web}_{\text{gr}}}(\vec{K})$  we have

$$(4-2) \quad \text{tr}(u) = (-1)^K I_q(\text{tr}(I_q(I_{\text{gr}}(u)))).$$

It suffices to prove  $\text{tr}(u) = (-1)^K I_q(\text{tr}(I_{\text{gr}}(u)))$  in the case where  $u$  is a primitive web (a morphism that consists of a single web with coefficient 1, which is thus invariant under  $I_q$ ). In Lemma 4.1 we have met evaluation relations for monochromatic green webs of edge label at most 2, but clearly analogous relations can be derived for red and mixed webs. In fact, all necessary evaluation relations are invariant under  $I_{\text{gr}}$  and  $I_q$ , except the two relations in (4-1). The circle relation is  $I_{\text{gr}}$ –invariant, but acquires a sign under  $I_q$ . The following computation shows that the green and red bubble relations also respect (4-2):

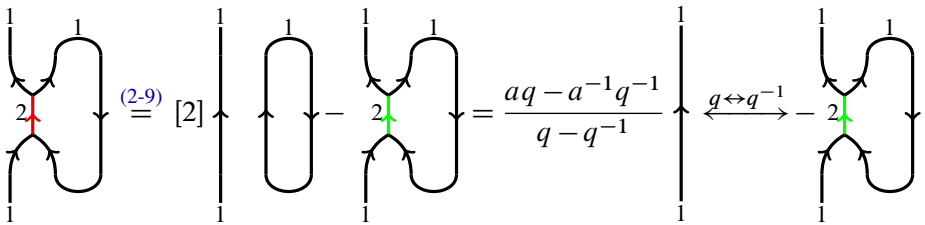

We note that in the computation of  $\text{tr}(u)$  via Lemma 4.1 strands can only be removed by circle moves and bubble moves. Both of these acquire a sign under  $I_q$ , which causes the factor  $(-1)^K$  in (4-2). This proves the claim.

Let  $b_D^K$  be a braid diagram that closes to a diagram of  $\mathcal{K}$  and suppose that  $\mathcal{K}$  is labeled by a Young diagram  $\lambda$  of with  $L$  nodes. Let  $\tilde{b}_D^{KL}$  be the  $L$ -fold cable of the braid diagram  $b_D^K$ .

Now we have

$$\begin{aligned} \mathcal{P}^{a,q}(\mathcal{K}(\lambda)) &= \text{tr}(p_{KL}(\tilde{b}_D^{KL})e_q(\lambda)^{\otimes K}) \\ &= (-1)^{KL} I_q(\text{tr}(I_q(I_{\text{gr}}(p_{KL}(\tilde{b}_D^{KL})e_q(\lambda)^{\otimes K})))) \\ &= (-1)^{KL+\text{cr}L^2} I_q(\text{tr}(p_{KL}(\tilde{b}_D^{KL})e_q(\lambda^T)^{\otimes K})) = (-1)^L \mathcal{P}^{a,q^{-1}}(\mathcal{K}(\lambda^T)), \end{aligned}$$

where  $\text{cr}$  is the number of crossings of  $b_D^K$ . Here we have used (4-2) and that  $I_q I_{\text{gr}}$  acts as  $-1$  on black crossings — see Example 2.18 — while sending  $e_q(\lambda)$  to  $e_q(\lambda^T)$  plus a commutator (which is zero in the trace), see Lemma 2.28. Moreover,  $(-1)^{KL+\text{cr}L^2} = (-1)^L$  since  $\text{cr} \equiv K - 1 \pmod 2$  as  $b_D^K$  closes into a knot.  $\square$

### 4.2 The colored $\mathfrak{sl}_N$ -link polynomials via the categories $N\text{-Web}_{\text{gr}}$

Recall that the colored Reshetikhin–Turaev  $\mathfrak{sl}_N$ -link polynomial  $\mathcal{RT}^{q^N,q}(\mathcal{L}(\vec{\lambda}))$  are determined by the corresponding colored HOMFLY-PT polynomials  $\mathcal{P}^{a,q}(\mathcal{L}(\vec{\lambda}))$  by specializing  $a = q^N$ . Alternatively, they can be computed directly inside the categories  $N\text{-Web}_{\text{gr}}$  from a framed, oriented, labeled link diagram as follows:

- First we replace all  $\lambda$ -labeled strands in the link diagram by cables equipped with the diagrammatic idempotent  $e_q(\lambda)$ , written in monochromatic green webs.
- The resulting diagram will contain downward-oriented green edges of label  $k$ , which we replace by upward-oriented green edges of label  $N-k$ . Simultaneously, caps and cups are replaced by splits and merges

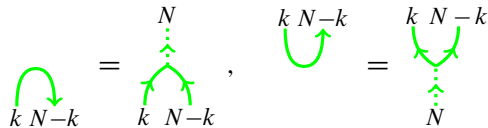

- The result is a morphism in  $N\text{-Web}_{\text{gr}}$  between objects consisting only of entries 0 and  $N_g$ . It follows from [Theorem 3.20](#) that this Hom-space is one-dimensional. Thus, the framed, oriented, labeled link diagram determines a polynomial, which is the desired colored Reshetikhin–Turaev  $\mathfrak{sl}_N$ -link polynomial.

Recall from [Remark 1.1](#) that this approach relies on the fact that  $\mathfrak{sl}_N\text{-Mod}_{\text{es}}$  contains the duality isomorphisms  $\bigwedge_q^k \mathbb{C}_q^N \cong (\bigwedge_q^{N-k} \mathbb{C}_q^N)^*$ . In [Remark 5.12](#) we sketch how to include duals in diagrammatic presentations of  $\mathfrak{gl}_{N|M}\text{-Mod}_{\text{es}}$  and  $\mathfrak{gl}_{m|n}\text{-Mod}_{\text{es}}$  and, thus, to compute the corresponding Reshetikhin–Turaev  $\mathfrak{gl}_N$  or  $\mathfrak{gl}_{m|n}$ -link invariants.

## 5 Generalization to webs for $\mathfrak{gl}_{N|M}$

We now give a diagrammatic presentation of  $\mathfrak{gl}_{N|M}\text{-Mod}_{\text{es}}$ , the (additive closure of the) braided monoidal category of  $U_q(\mathfrak{gl}_{N|M})$ -modules tensor generated by the exterior  $\bigwedge_q^k \mathbb{C}_q^{N|M}$  and the symmetric  $\text{Sym}_q^l \mathbb{C}_q^{N|M}$  powers of the vector representation  $\mathbb{C}_q^{N|M}$  of  $U_q(\mathfrak{gl}_{N|M})$ . The diagrammatic presentation is given by the following quotient of  $\infty\text{-Web}_{\text{gr}}$ .

**Definition 5.1** The category  $N|M\text{-Web}_{\text{gr}}$  is the quotient category obtained from  $\infty\text{-Web}_{\text{gr}}$  by imposing the *not-a-hook relation*, that is,

$$e_q(\text{box}_{N+1, M+1}) = 0,$$

where  $\text{box}_{N+1, M+1}$  is the box-shaped Young diagram with  $N + 1$  rows and  $M + 1$  columns. ◊

Note that  $N|M\text{-Web}_{\text{gr}}$  inherits the braiding  $\beta^{\bullet, \bullet}$  from  $\infty\text{-Web}_{\text{gr}}$ .

**Example 5.2** If we take  $M = 0$ , then  $\text{box}_{N+1, 1}$  is a column Young diagram with  $N + 1$  nodes and the corresponding not-a-hook relation is just the exterior relation [\(2-10\)](#). In this case we have that  $N|0\text{-Web}_{\text{gr}}$  is  $N\text{-Web}_{\text{gr}}$  and  $\mathfrak{gl}_{N|0}\text{-Mod}_{\text{es}}$  is isomorphic to  $\mathfrak{gl}_N\text{-Mod}_{\text{es}}$ . ◀

**Example 5.3** If we take  $M = N = 1$ , then we have

$$\tilde{e}_q(\text{box}_{2,2}) = \tilde{e}_q \left( \begin{array}{|c|c|} \hline \square & \square \\ \hline \square & \square \\ \hline \end{array} \right)$$

$$= \frac{1}{[2]^4} \left( \text{Diagram 1} \right) = -\frac{1}{[2]^4} \left( \text{Diagram 2} \right) = \frac{1}{[2]^4} \left( \text{Diagram 3} \right)$$



It is easy to see that  $e_q(\text{box}_{2,2}) = 0$  is equivalent to the relations [27, (3.3.13a) and (3.3.13b)], [9, Section 3.6] and [23, Corollary 6.18], which are used to describe the “purely exterior” representation category  $\mathfrak{gl}_{1|1}\text{-Mod}_e$ . This category could be presented as monochromatic green subcategory of  $1|1\text{-Web}_{\text{gr}}$ , defined analogously as in Definition 2.7. ◁

To prove that  $N|M\text{-Web}_{\text{gr}}$  gives a diagrammatic presentation of  $\mathfrak{gl}_{N|M}\text{-Mod}_{\text{es}}$ , we use a version of super  $q$ -Howe duality between  $U_q(\mathfrak{gl}_{m|n})$  and  $U_q(\mathfrak{gl}_{N|M})$ . For this, we say a dominant integral  $\mathfrak{gl}_{m|n}$ -weight  $\lambda$  is  $(m|n, M|N)$ -supported if it corresponds to a Young diagram which is simultaneously an  $(m|n)$ -hook as well as an  $(M|N)$ -hook.<sup>9</sup>

**Theorem 5.4** (Super  $q$ -Howe duality, super-super version) *We have the following:*

- (a) Let  $K \in \mathbb{Z}_{\geq 0}$ . The actions of  $U_q(\mathfrak{gl}_{m|n})$  and  $U_q(\mathfrak{gl}_{N|M})$  on  $\bigwedge_q^K(\mathbb{C}_q^{m|n} \otimes \mathbb{C}_q^{N|M})$  commute and generate each others commutant.
- (b) There exists an isomorphism

$$\bigwedge_q^\bullet(\mathbb{C}_q^{m|n} \otimes \mathbb{C}_q^{N|M}) \cong (\bigwedge_q^\bullet \mathbb{C}_q^{N|M})^{\otimes m} \otimes (\text{Sym}_q^\bullet \mathbb{C}_q^{N|M})^{\otimes n}$$

of  $U_q(\mathfrak{gl}_{N|M})$ -modules under which the  $\vec{k}$ -weight space of  $\bigwedge_q^\bullet(\mathbb{C}_q^{m|n} \otimes \mathbb{C}_q^{N|M})$  (considered as a  $U_q(\mathfrak{gl}_{m|n})$ -module) is identified with

$$\begin{aligned} \bigwedge_q^{\vec{k}_0} \mathbb{C}_q^{N|M} \otimes \text{Sym}_q^{\vec{k}_1} \mathbb{C}_q^{N|M} = \\ \bigwedge_q^{k_1} \mathbb{C}_q^{N|M} \otimes \dots \otimes \bigwedge_q^{k_m} \mathbb{C}_q^{N|M} \otimes \text{Sym}_q^{k_{m+1}} \mathbb{C}_q^{N|M} \otimes \dots \otimes \text{Sym}_q^{k_{m+n}} \mathbb{C}_q^{N|M}. \end{aligned}$$

Here  $\vec{k} = (k_1, \dots, k_{m+n})$ ,  $\vec{k}_0 = (k_1, \dots, k_m)$  and  $\vec{k}_1 = (k_{m+1}, \dots, k_{m+n})$ .

- (c) As  $U_q(\mathfrak{gl}_{m|n}) \otimes U_q(\mathfrak{gl}_{N|M})$ -modules, we have a decomposition of the form

$$\bigwedge_q^K(\mathbb{C}_q^{m|n} \otimes \mathbb{C}_q^{N|M}) \cong \bigoplus_{\lambda} L_{m|n}(\lambda) \otimes L_{N|M}(\lambda^T),$$

where we sum over all  $(m|n, M|N)$ -supported  $\mathfrak{gl}_{m|n}$ -weights  $\lambda$  whose entries sum up to  $K$ . This induces a decomposition

$$\bigwedge_q^\bullet(\mathbb{C}_q^{m|n} \otimes \mathbb{C}_q^{N|M}) \cong \bigoplus_{\lambda} L_{m|n}(\lambda) \otimes L_{N|M}(\lambda^T),$$

where we sum over all  $(m|n, M|N)$ -supported  $\mathfrak{gl}_{m|n}$ -weights  $\lambda$ .

<sup>9</sup>This is really intended to be  $(M|N)$ .

**Proof** As before, (a) and (c) are proven in [23, Theorem 4.2] and only (b) remains to be verified. This works similarly as in the proof of Theorem 3.6 and is left to the reader. For a nonquantized version see [28, Proposition 2.2].  $\square$

In the statement of this theorem,  $\bigwedge_q^k \mathbb{C}_q^{N|M}$ ,  $\text{Sym}_q^l \mathbb{C}_q^{N|M}$  and  $\bigwedge_q^K (\mathbb{C}_q^{m|n} \otimes \mathbb{C}_q^{N|M})$  are defined similarly as in Section 3.1; see also [23, Section 3]. As before we then get:

**Corollary 5.5** *There exists a full functor  $\Phi_{\text{su}}^{m|n}: \dot{U}_q(\mathfrak{gl}_{m|n}) \rightarrow \mathfrak{gl}_{N|M}\text{-Mod}_{\text{es}}$ , which we again call the super  $q$ -Howe functor, given on objects and morphisms by*

$$\Phi_{\text{su}}^{m|n}(\vec{k}) = \bigwedge_q^{\vec{k}_0} \mathbb{C}_q^{N|M} \otimes \text{Sym}_q^{\vec{k}_1} \mathbb{C}_q^{N|M}, \quad \Phi_{\text{su}}^{m|n}(1_{\vec{l}} x 1_{\vec{k}}) = f_{\vec{k}}^{\vec{l}}(x).$$

Everything else is sent to zero.  $\square$

In what follows, we denote by  $\dot{U}_q(\mathfrak{gl}_{m|n})^{\geq 0}$  the quotient of  $\dot{U}_q(\mathfrak{gl}_{m|n})$  obtained by killing all  $\mathfrak{gl}_{m|n}$ -weights with negative entries.

**Corollary 5.6** *The super  $q$ -Howe functor  $\Phi_{\text{su}}^{m|n}$  from Corollary 5.5 induces an algebra epimorphism (denoted by the same symbol) as in the diagram:*

$$\begin{array}{ccc} \dot{U}_q(\mathfrak{gl}_{m|n})^{\geq 0} & \xrightarrow{\cong} & \bigoplus_{\text{hooks } \lambda} (m|n)\text{-} \text{End}_{\mathbb{C}_q}(L_{m|n}(\lambda)) \\ \Phi_{\text{su}}^{m|n} \downarrow & & \downarrow \pi \\ \text{End}_{U_q(\mathfrak{gl}_{N|M})}(\bigwedge_q^{\bullet} (\mathbb{C}_q^{m|n} \otimes \mathbb{C}_q^{N|M})) & \xrightarrow{\cong} & \bigoplus_{\text{supported } \lambda} (m|n, M|N)\text{-} \text{End}_{\mathbb{C}_q}(L_{m|n}(\lambda)) \end{array}$$

Under Artin–Wedderburn decompositions,  $\Phi_{\text{su}}^{m|n}$  corresponds to an algebra epimorphism  $\pi$ , which acts on the summand  $\text{End}_{\mathbb{C}_q}(L_{m|n}(\lambda))$  either as an isomorphism or as zero, depending on whether the Young diagram  $\lambda$  is  $(m|n, M|N)$ -supported or not.

**Proof** First, note that by Theorem 3.22,  $\dot{U}_q(\mathfrak{gl}_{m|n})^{\geq 0}$  is isomorphic to  $\check{H}_{m+n}^{\text{sort}}$ , the sorted version of  $\check{H}$  with exactly  $m$  exterior strands and  $n$  symmetric strands. The Artin–Wedderburn decomposition in the top row of the diagram is then given in [21, Theorem 5.1]. The bottom Artin–Wedderburn decomposition follows directly from part (c) of Theorem 5.4.  $\square$

**Remark 5.7** We obtain from Corollary 5.6 an alternative proof of the presentation of the  $q$ -Schur superalgebra  $S_q(N|M, K) \cong \text{End}_{H_K(q)}((\mathbb{C}_q^{N|M})^{\otimes K})$  from [5, Theorem 3.13.1].

**Lemma 5.8** Under the correspondence

$$\check{H}_{m+n}^{\text{sort}} \xleftrightarrow{\cong} \dot{U}_q(\mathfrak{gl}_{m|n})^{\geq 0} \xleftrightarrow{\cong} \bigoplus_{(m|n)\text{-hooks } \lambda} \text{End}_{\mathbb{C}_q}(L_{m|n}(\lambda)),$$

the kernel of the super  $q$ -Howe functor  $\Phi_{\text{su}}^{m|n}$  from Corollary 5.5 is given by the tensor ideal  $I_{\text{box}}$  in  $\check{H}_{m+n}^{\text{sort}}$  generated by the primitive idempotent  $e_q(\text{box}_{N+1, M+1})$ .

**Proof** From the right isomorphism we know that the kernel of  $\Phi_{\text{su}}^{m|n}$  is generated by all  $e_q(\lambda^T)$  where  $\lambda$  is an  $(m|n)$ -hook, but not an  $(M|N)$ -hook. Every such  $\lambda$  corresponds to a simple  $U_q(\mathfrak{gl}_{N|M})$ -module which appears in a tensor product  $L_{N|M}((\text{box}_{N+1, M+1})^T) \otimes (\mathbb{C}_q^{N|M})^{\otimes K}$  for some  $K \in \mathbb{Z}_{\geq 0}$ . Accordingly,  $e_q(\lambda^T)$  is contained in the ideal  $I_{\text{box}}$ .  $\square$

**Proposition 5.9** There is an equivalence of categories

$$\text{Mat}(N|M\text{-Web}_{\text{gr}}^{\text{sort}}) \cong \mathfrak{gl}_{N|M}\text{-Mod}_{\text{es}}^{\text{sort}}.$$

**Proof** Lemma 5.8 shows that the sorted web category  $N|M\text{-Web}_{m+n}^{\text{sort}}$ , in which webs have  $m$  green and  $n$  red boundary points both on the bottom and on the top, is equivalent to  $\text{End}_{U_q(\mathfrak{gl}_{N|M})}(\bigwedge_q^{\bullet}(\mathbb{C}_q^{m|n} \otimes \mathbb{C}_q^{N|M}))$ , considered as a category. Via the  $\dot{U}_q(\mathfrak{gl}_{m|n})$ -weight space decomposition in Theorem 5.4(b),  $N|M\text{-Web}_{m+n}^{\text{sort}}$  gives a presentation of the morphism spaces in  $\mathfrak{gl}_{N|M}\text{-Mod}_{\text{es}}^{\text{sort}}$  between objects of the form

$$\bigwedge_q^{k_1} \mathbb{C}_q^{N|M} \otimes \dots \otimes \bigwedge_q^{k_m} \mathbb{C}_q^{N|M} \otimes \text{Sym}_q^{k_{m+1}} \mathbb{C}_q^{N|M} \otimes \dots \otimes \text{Sym}_q^{k_{m+n}} \mathbb{C}_q^{N|M}.$$

Any object in  $\mathfrak{gl}_{N|M}\text{-Mod}_{\text{es}}^{\text{sort}}$  is a formal sum of such objects for suitable  $m, n \in \mathbb{Z}_{\geq 0}$ , and the conclusion follows.  $\square$

**Remark 5.10** Recall that  $\mathfrak{gl}_{N|M}\text{-Mod}_{\text{es}}$  is a braided monoidal category, where the braiding  $\beta_{\cdot, \cdot}^R$  is given by the universal  $R$ -matrix for  $\mathfrak{gl}_{N|M}$ ; see [32]. As before, we use a rescaled braiding  $\tilde{\beta}_{\cdot, \cdot}^R$ , where we follow the conventions from [23, (3.12)] except that we substitute  $q$  by  $q^{-1}$  in their formulas. In particular,  $\tilde{\beta}_{\mathbb{C}_q^{N|M}, \mathbb{C}_q^{N|M}}^R$  acts as  $-q^{-1}$  on  $\bigwedge_q^2 \mathbb{C}_q^{N|M}$  and as  $q$  on  $\text{Sym}_q^2 \mathbb{C}_q^{N|M}$ .

**Theorem 5.11** (The diagrammatic presentation) There is an equivalence of braided monoidal categories

$$(\text{Mat}(N|M\text{-Web}_{\text{gr}}), \beta_{\cdot, \cdot}^{\bullet}) \cong (\mathfrak{gl}_{N|M}\text{-Mod}_{\text{es}}, \beta_{\cdot, \cdot}^R).$$

**Proof** The equivalence from [Proposition 5.9](#) can be extended to a monoidal functor between the categories  $\mathbf{Mat}(N|M\text{-Web}_{\text{gr}})$  and  $\mathfrak{gl}_{N|M}\text{-Mod}_{\text{es}}$  as in [Definition 3.17](#). We can also copy the proof of [Proposition 3.19](#), where we use [Remark 5.10](#) to prove that this functor respects the braiding. Equivalence via this functor follows then as in [Theorem 3.20](#).  $\square$

**Remark 5.12** In [[23](#), Section 6] the authors show how to extend a diagrammatic presentation of  $\mathfrak{gl}_{N|M}\text{-Mod}_{\text{e}}$  to diagrammatically encode the full subcategory of  $U_q(\mathfrak{gl}_{N|M})$ -modules tensor generated by exterior powers and their duals. Graphically, this involves the introduction of additional objects corresponding to the duals of exterior powers, downward-oriented edges (to represent identity morphisms on duals) and cap and cup webs (which represent coevaluation and evaluation morphisms). Additional web relations including analogues of (4-1) are introduced to encode basic relationships between exterior powers and their duals. The extension of the diagrammatic presentation to include duals is then tautological and [[23](#), Theorem 6.5 and Proposition 6.16] show that the extended presentation functor is fully faithful.

They further show in [[23](#), Proposition 6.15] that their graphical calculus allows the computation of the Reshetikhin–Turaev  $\mathfrak{gl}_{N|M}$ -tangle invariants for tangles labeled with exterior powers of the vector representation.

The same *spiderization strategy* — with minimal changes in proofs — gives an extension of our diagrammatic presentation  $N|M\text{-Web}_{\text{gr}}$  of  $\mathfrak{gl}_{N|M}\text{-Mod}_{\text{es}}$  to one for the full subcategory of  $U_q(\mathfrak{gl}_{N|M})$ -modules tensor generated by exterior and symmetric powers and their duals. This spiderized green–red web category directly allows the computation of Reshetikhin–Turaev  $\mathfrak{gl}_{N|M}$ -tangle invariants for tangles labeled with exterior as well as symmetric powers of the vector representation. The cabling strategy from [Section 4](#) can then be used to compute these invariants with respect to arbitrary irreducible representations.

Lastly, we have a direct consequence of the discussion in this section and [Proposition 4.4](#). It is based on the facts that  $N|M\text{-Web}_{\text{gr}}$  is defined as a quotient of  $\infty\text{-Web}_{\text{gr}}$  and that the spiderization in [[23](#), Section 6] respects the specialization  $a = q^{N-M}$  of the relations (4-1), which are sufficient to compute colored HOMFLY–PT polynomials of braid closures.

**Corollary 5.13** *We have:*

- (1) *The Reshetikhin–Turaev  $\mathfrak{gl}_{N|M}$ -tangle invariant of a labeled tangle depends only on  $N - M$ . In the case of a labeled link, it agrees with the specialization  $a = q^{N-M}$  of the corresponding colored HOMFLY–PT polynomial.*

- (2) The green–red symmetry on  $\infty\text{-Web}_{\text{gr}}$  descends to a symmetry between the categories  $N|M\text{-Web}_{\text{gr}}$  and  $M|N\text{-Web}_{\text{gr}}$ . Hence, there is a symmetry between the representation categories of  $U_q(\mathfrak{gl}_{N|M})$  and  $U_q(\mathfrak{gl}_{M|N})$  that transposes Young diagrams indexing irreducibles.
- (3) The symmetry of HOMFLY–PT polynomials described in Proposition 4.4 is a stabilized version of the symmetry between colored Reshetikhin–Turaev  $\mathfrak{gl}_{N|M}$ –link invariants and  $\mathfrak{gl}_{M|N}$ –link invariants which transposes Young diagrams and inverts  $q$ .  $\square$

This confirms decategorified analogues of predictions about relationships between colored HOMFLY–PT homology and conjectural colored  $\mathfrak{gl}_{N|M}$ –link homologies; see [7].

## References

- [1] **A K Aiston, H R Morton**, *Idempotents of Hecke algebras of type A*, J. Knot Theory Ramifications 7 (1998) 463–487 [MR](#)
- [2] **A Berenstein, S Zwicknagl**, *Braided symmetric and exterior algebras*, Trans. Amer. Math. Soc. 360 (2008) 3429–3472 [MR](#)
- [3] **S Cautis, J Kamnitzer, S Morrison**, *Webs and quantum skew Howe duality*, Math. Ann. 360 (2014) 351–390 [MR](#)
- [4] **S-J Cheng, W Wang**, *Howe duality for Lie superalgebras*, Compositio Math. 128 (2001) 55–94 [MR](#)
- [5] **H El Turkey, J R Kujawa**, *Presenting Schur superalgebras*, Pacific J. Math. 262 (2013) 285–316 [MR](#)
- [6] **N Geer, B Patureau-Mirand**, *On the colored HOMFLY–PT, multivariable and Kashaev link invariants*, Commun. Contemp. Math. 10 (2008) 993–1011 [MR](#)
- [7] **E Gorsky, S Gukov, M Stošić**, *Quadruply-graded colored homology of knots*, preprint (2013) [arXiv](#)
- [8] **J Grant**, *A categorification of the skew Howe action on a representation category of  $U_q(\mathfrak{gl}(m|n))$* , preprint (2015) [arXiv](#)
- [9] **J Grant**, *A generators and relations description of a representation category of  $U_q(\mathfrak{gl}(1|1))$* , Algebr. Geom. Topol. 16 (2016) 509–539 [MR](#)
- [10] **S Gukov, M Stošić**, *Homological algebra of knots and BPS states*, from “Proceedings of the Freedman Fest” (R Kirby, V Krushkal, Z Wang, editors), Geom. Topol. Monogr. 18, Geom. Topol. Publ., Coventry (2012) 309–367 [MR](#)
- [11] **A Gyoja**, *A  $q$ -analogue of Young symmetrizer*, Osaka J. Math. 23 (1986) 841–852 [MR](#)

- [12] **R Howe**, *Perspectives on invariant theory: Schur duality, multiplicity-free actions and beyond*, from “The Schur lectures” (I Piatetski-Shapiro, S Gelbart, editors), Israel Math. Conf. Proc. 8, Bar-Ilan Univ., Ramat Gan (1995) 1–182 [MR](#)
- [13] **V F R Jones**, *Hecke algebra representations of braid groups and link polynomials*, Ann. of Math. 126 (1987) 335–388 [MR](#)
- [14] **L H Kauffman, S L Lins**, *Temperley–Lieb recoupling theory and invariants of 3–manifolds*, Annals of Mathematics Studies 134, Princeton Univ. Press (1994) [MR](#)
- [15] **G Kuperberg**, *Spiders for rank 2 Lie algebras*, Comm. Math. Phys. 180 (1996) 109–151 [MR](#)
- [16] **J-H Kwon**, *Crystal bases of  $q$ -deformed Kac modules over the quantum superalgebras  $U_q(\mathfrak{gl}(m|n))$* , Int. Math. Res. Not. 2014 (2014) 512–550 [MR](#)
- [17] **X-S Lin, H Zheng**, *On the Hecke algebras and the colored HOMFLY polynomial*, Trans. Amer. Math. Soc. 362 (2010) 1–18 [MR](#)
- [18] **K Liu, P Peng**, *Proof of the Labastida–Mariño–Ooguri–Vafa conjecture*, J. Differential Geom. 85 (2010) 479–525 [MR](#)
- [19] **S Lukac**, *Homfly skeins and the Hopf link*, PhD thesis, University of Liverpool (2001) Available at <http://www.liv.ac.uk/~su14/papers/lukacthesis.pdf>
- [20] **G Lusztig**, *Introduction to quantum groups*, Progress in Mathematics 110, Birkhäuser, Boston, MA (1993) [MR](#)
- [21] **H Mitsuhashi**, *Schur–Weyl reciprocity between the quantum superalgebra and the Iwahori–Hecke algebra*, Algebr. Represent. Theory 9 (2006) 309–322 [MR](#)
- [22] **H Murakami, T Ohtsuki, S Yamada**, *Homfly polynomial via an invariant of colored plane graphs*, Enseign. Math. 44 (1998) 325–360 [MR](#)
- [23] **H Queffelec, A Sartori**, *Mixed quantum skew Howe duality and link invariants of type A*, preprint (2015) [arXiv](#)
- [24] **J Rasmussen**, *Some differentials on Khovanov–Rozansky homology*, Geom. Topol. 19 (2015) 3031–3104 [MR](#)
- [25] **D E V Rose, D Tubbenhauer**, *Symmetric webs, Jones–Wenzl recursions, and  $q$ -Howe duality*, Int. Math. Res. Not. 2016 (2016) 5249–5290 [MR](#)
- [26] **G Rumer, E Teller, H Weyl**, *Eine für die Valenztheorie geeignete Basis der binären Vektorinvarianten*, Nachr. Ges. Wiss. Göttingen, Math.-Phys. Kl. 1932 (1932) 499–504
- [27] **A Sartori**, *Categorification of tensor powers of the vector representation of  $U_q(\mathfrak{gl}(1|1))$* , PhD thesis, Universität Bonn (2014) Available at <http://hss.ulb.uni-bonn.de/2014/3635/3635.pdf>
- [28] **A Sartori**, *Categorification of tensor powers of the vector representation of  $U_q(\mathfrak{gl}(1|1))$* , Selecta Math. 22 (2016) 669–734 [MR](#)

- [29] **V G Turaev**, *Quantum invariants of knots and 3-manifolds*, revised edition, De Gruyter Studies in Mathematics 18, Walter de Gruyter, Berlin (2010) [MR](#)
- [30] **G Williamson**, *Singular Soergel bimodules*, Int. Math. Res. Not. 2011 (2011) 4555–4632 [MR](#)
- [31] **Y Wu, R B Zhang**, *Unitary highest weight representations of quantum general linear superalgebra*, J. Algebra 321 (2009) 3568–3593 [MR](#)
- [32] **H Yamane**, *Quantized enveloping algebras associated with simple Lie superalgebras and their universal  $R$ -matrices*, Publ. Res. Inst. Math. Sci. 30 (1994) 15–87 [MR](#)
- [33] **R B Zhang**, *Structure and representations of the quantum general linear supergroup*, Comm. Math. Phys. 195 (1998) 525–547 [MR](#)

*Mathematisches Institut, Universität Bonn  
Bonn, Germany*

*Institut de Recherche en Mathématique et Physique, Université Catholique de Louvain  
Louvain-la-Neuve, Belgium*

*Department of Mathematics, Imperial College London  
London, United Kingdom*

[dtubben@math.uni-bonn.de](mailto:dtubben@math.uni-bonn.de), [pedro.vaz@uclouvain.be](mailto:pedro.vaz@uclouvain.be), [p.wedrich@gmail.com](mailto:p.wedrich@gmail.com)  
<http://www.math.uni-bonn.de/people/dtubben/>,  
<http://perso.uclouvain.be/pedro.vaz/>, <http://paul.wedrich.at/>

Received: 16 October 2016      Revised: 1 March 2017

