

Ideal boundaries of pseudo-Anosov flows and uniform convergence groups with connections and applications to large scale geometry

SÉRGIO FENLEY

Given a general pseudo-Anosov flow in a closed three manifold, the orbit space of the lifted flow to the universal cover is homeomorphic to an open disk. We construct a natural compactification of this orbit space with an ideal circle boundary. If there are no perfect fits between stable and unstable leaves and the flow is not topologically conjugate to a suspension Anosov flow, we then show: The ideal circle of the orbit space has a natural quotient space which is a sphere. This sphere is a dynamical systems ideal boundary for a compactification of the universal cover of the manifold. The main result is that the fundamental group acts on the flow ideal boundary as a uniform convergence group. Using a theorem of Bowditch, this yields a proof that the fundamental group of the manifold is Gromov hyperbolic and it shows that the action of the fundamental group on the flow ideal boundary is conjugate to the action on the Gromov ideal boundary. This gives an entirely new proof that the fundamental group of a closed, atoroidal 3–manifold which fibers over the circle is Gromov hyperbolic. In addition with further geometric analysis, the main result also implies that pseudo-Anosov flows without perfect fits are quasigeodesic flows and that the stable/unstable foliations of these flows are quasi-isometric foliations. Finally we apply these results to (nonsingular) foliations: if a foliation is \mathbf{R} –covered or with one sided branching in an aspherical, atoroidal three manifold then the results above imply that the leaves of the foliation in the universal cover extend continuously to the sphere at infinity.

[37C85](#), [37D20](#), [53C23](#), [57R30](#); [58D19](#), [37D50](#), [57M50](#)

1 Introduction

The main purpose of this article is to analyze what information can be obtained about the asymptotic structure or large scale geometry of the universal cover of a manifold using only the dynamics of a pseudo-Anosov flow in the manifold. We introduce a dynamical systems ideal boundary for a large class of such flows and a corresponding compactification of the universal cover. The fundamental group acts on the flow ideal boundary and compactification with excellent dynamical properties. These objects are

later shown to be strongly related to the large scale geometry of the manifolds and of the flows themselves. They also imply results about the geometry of foliations.

In three-manifold theory, the universal cover of the manifold plays a crucial role. Topologically one is invariably interested that the universal cover is \mathbf{R}^3 ; see Waldhausen [66] and Hempel [42]. In terms of geometry, for example, Thurston showed that a large class of manifolds are hyperbolic (see Thurston [58; 59; 62], Morgan [46] and Otal [53; 52]) and the asymptotic or large scale structure of the universal cover was very important for these results.

Our goal is to analyze what can a flow say about the asymptotic structure of the universal cover of the manifold. Here we consider pseudo-Anosov flows as they have rich dynamics and have been shown to be strongly connected to the geometry by Thurston [62] and Otal [53] and topology of 3-manifolds by Gabai and Oertel [36] and the author [26]. Gabai and Oertel proved for example that the universal cover of the underlying manifold is \mathbf{R}^3 [36]. We will prove that under certain hypothesis the dynamics of the flow creates a much richer asymptotic structure for the universal cover.

In this article all manifolds are connected.

We start by analysing the orbit space of the flow. Suppose that Φ is a general pseudo-Anosov flow in a closed 3-manifold M . Such flows are very common; see Thurston [60; 61], Casson and Bleiler [17], Mosher [48; 49; 50], Fenley [26] and Calegari [10; 11]. The flow has associated stable and unstable (possibly singular) 2-dimensional foliations Λ^s, Λ^u . When there are no singularities the flow is called an Anosov flow. Let $\tilde{\Phi}$ be the lifted flow to the universal cover \tilde{M} and let \mathcal{O} be the orbit space of $\tilde{\Phi}$. This orbit space is always homeomorphic to an open disk by work of the author alone [21] and with Mosher [29]. The fundamental group of M acting on \tilde{M} by covering translations, leaves invariant the foliation of \tilde{M} by flowlines of $\tilde{\Phi}$. Hence this induces an action of the fundamental group on \mathcal{O} . The stable and unstable foliations of Φ lifted to the universal cover also induce one-dimensional foliations in \mathcal{O} .

Theorem A *Let Φ be a pseudo-Anosov flow in a closed 3-manifold M . There is a natural construction of a compactification $\mathcal{D} = \mathcal{O} \cup \partial\mathcal{O}$, obtained solely from the stable and unstable foliations in \mathcal{O} . The boundary $\partial\mathcal{O}$ is homeomorphic to a circle and the compactification \mathcal{D} is homeomorphic to a disk, whose boundary circle is $\partial\mathcal{O}$. Since the fundamental group of M preserves the stable and unstable foliations in \mathcal{O} , it follows that $\pi_1(M)$ acts by homeomorphisms on the compactification \mathcal{D} and also along the boundary circle $\partial\mathcal{O}$.*

We stress that compactifications of \mathcal{O} are not unique, even compactifications to a closed disk. For example given a point p in the above mentioned ideal boundary $\partial\mathcal{O}$, one

can blow each point of the $\pi_1(M)$ orbit of p to a segment. By doing this carefully the ensuing compactification of \mathcal{O} is again a closed disk where one can define a (nonnatural) action of $\pi_1(M)$.

The stable/unstable foliations $\tilde{\Lambda}^s, \tilde{\Lambda}^u$ in the universal cover project to 1–dimensional foliations $\mathcal{O}^s, \mathcal{O}^u$ in \mathcal{O} . The possible singularities are only of p –prong type with $p \geq 3$ (the condition $p \geq 3$ is necessary for all the results in this article). The prototype here is a suspension pseudo-Anosov flow over a hyperbolic surface. In this case \mathcal{O} is identified with a lift of a fiber and it is possible to prove that the ideal circle boundary of \mathcal{O} constructed in [Theorem A](#) is identified with the circle at infinity of the lift of the fiber. In this example $\mathcal{O}^s, \mathcal{O}^u$ in \mathcal{O} correspond to the stable and unstable foliations of the monodromy of the fiber lifted to the universal cover of the fiber. We stress that in general there is no geometry (even coarse geometry) in the space \mathcal{O} .

For general pseudo-Anosov flows, an ideal point of \mathcal{O} will be defined as an equivalence class of nested sequences of polygonal paths. A *polygonal path* is a properly embedded, bi-infinite path in \mathcal{O} made up of a finite collection of segments alternatively in $\mathcal{O}^s, \mathcal{O}^u$ and 2 rays of \mathcal{O}^s or \mathcal{O}^u at the ends. In general one needs to use polygonal paths rather than just leaves of $\mathcal{O}^s, \mathcal{O}^u$ to define ideal points of \mathcal{O} because of an obstruction which is called a perfect fit, as explained below. Any ray of a leaf of $\mathcal{O}^s, \mathcal{O}^u$ is properly embedded in \mathcal{O} and defines an ideal point of \mathcal{O} , but there are many other points. There is a natural group invariant topology in $\mathcal{D} = \mathcal{O} \cup \partial\mathcal{O}$ – this is a fundamental point here: the ideal points ($\partial\mathcal{O}$) and the topology in \mathcal{D} are constructed using only the foliations $\mathcal{O}^s, \mathcal{O}^u$ in \mathcal{O} . Since these foliations are invariant under the action by the fundamental group of M , this group acts on \mathcal{D} by homeomorphisms. The proof that \mathcal{D} is homeomorphic to a closed disk is very involved and extremely long. We show that $\partial\mathcal{O}$ has a natural cyclic order and that $\partial\mathcal{O}$ is metrizable, connected and more importantly it is compact. The last property is very hard to prove. Point set topology theorems and additional work show that $\partial\mathcal{O}$ is homeomorphic to a circle and \mathcal{D} is homeomorphic to a closed disk. This works for any pseudo-Anosov flow.

We remark that Calegari and Dunfield [\[13\]](#) previously showed that if Φ is a pseudo-Anosov flow, then $\pi_1(M)$ acts nontrivially on a circle, with very important consequences for the existence question of pseudo-Anosov flows [\[13\]](#). Their construction is very different than ours. They show that the space of ends of the leaf space of say $\tilde{\Lambda}^s$ is circularly ordered and maps injectively to a circle. By collapsing complementary intervals one gets an action on \mathbf{S}^1 . It is not entirely clear how to use the space of ends in order to produce an actual compactification of \mathcal{O} , where the group acts naturally and with good properties. For example, consider sequences escaping compact sets in \mathcal{O} with all points in the same stable leaf. As seen in the leaf space the points do not go into any end, but they should have a convergent subsequence in a compactification

of \mathcal{O} . In this article we produce an actual compactification of the orbit space \mathcal{O} as a closed disk. In addition very specific properties of the compactification as related to the stable/unstable foliations $\mathcal{O}^s, \mathcal{O}^u$ will be used for the geometric results in the second part of this article.

One main goal in introducing an ideal boundary for \mathcal{O} is that it leads to an understanding of the asymptotic behavior of \tilde{M} . Our objective is to give a fairly explicit dynamical systems description of the asymptotic behavior of the universal cover. We do not know how to do this in general – in this article we can only deal with pseudo-Anosov flows without perfect fits.

We first discuss perfect fits and their importance. An unstable leaf G of $\tilde{\Lambda}^u$ makes a *perfect fit* with a stable leaf F of $\tilde{\Lambda}^s$ if G and F do not intersect but they “almost” intersect: any other unstable leaf sufficiently near G (and in the F side), will intersect F and vice versa. See detailed definition in [Section 2](#) and [Figure 1\(a\)](#). We also use the terminology “perfect fits” for their projections to the orbit space. In the orbit space one can think of a perfect fit as a proper embedding in \mathcal{O} of a rectangle minus a corner. Stable (unstable) leaves correspond to horizontal (vertical) segments. The 2 boundary leaves without an endpoint form a perfect fit – one stable leaf (horizontal) and one unstable leaf (vertical). Perfect fits are very important in the topological theory of pseudo-Anosov flows; see Barbot [[1](#); [2](#)] and Fenley [[21](#); [22](#); [24](#); [25](#)]. They occur for instance whenever there are closed orbits of Φ which are freely homotopic [[24](#); [25](#)] or when the leaf space of $\tilde{\Lambda}^s$ or $\tilde{\Lambda}^u$ is not Hausdorff [[24](#); [25](#)]. Examples of flows without perfect fits are suspensions (with or without singularities) and many other interesting examples as described later.

For the results in this article, perfect fits are one main obstruction to simple definitions and proofs: For example consider a point p of $\partial\mathcal{O}$ which is associated to the ideal point of (say) an unstable ray l of \mathcal{O}^u . Let $(z_n)_{n \in \mathbb{N}}$ be a nested sequence of stable leaves intersecting l and so that the intersection with l escapes compact sets in l . What one strongly expects and hopes is that the sequence $(z_n)_{n \in \mathbb{N}}$ defines the ideal point p associated to l . In particular one expects that the leaves z_n escape compact sets in \mathcal{O} as n grows. This occurs in the suspension case and in many other situations, but in fact it does not always happen. When it does not occur, then the sequence (z_n) limits to a stable leaf r' in \mathcal{O} and one can then show that there is a stable leaf r (possibly $r = r'$), so that r and l form a perfect fit in \mathcal{O} . In this case the sequence (z_n) will *not* define the ideal point p . Conversely any perfect fit generates a sequence (z_n) as above. Because of perfect fits then to define ideal points of \mathcal{O} , one needs to consider not only leaves of $\mathcal{O}^s, \mathcal{O}^u$, but rather sequences of polygonal paths in $\mathcal{O}^s, \mathcal{O}^u$. The definition of ideal points, implies that if r ray of \mathcal{O}^u and l ray of \mathcal{O}^s form a perfect fit, then these rays define the same ideal point of \mathcal{O} . Suspension Anosov flows (without

singular orbits) are special and have to be treated differently, because in that case a sequence of stable leaves in \mathcal{O}^s escaping compact sets approaches infinitely many ideal points of \mathcal{O} .

When there are no perfect fits we construct the flow ideal boundary and compactification of \widetilde{M} . The flow ideal boundary is a quotient of $\partial\mathcal{O}$. The assumption of no perfect fits is fundamental for this result:

Theorem B *Let Φ be a pseudo-Anosov flow without perfect fits, not topologically conjugate to a suspension Anosov flow. Let \mathcal{O} be its orbit space and $\partial\mathcal{O}$ be the ideal boundary of [Theorem A](#). Consider the equivalence relation in $\partial\mathcal{O}$ generated by: two points are in the same class if they are ideal points of the same stable or unstable leaf in \mathcal{O} . Let \mathcal{R} be the set of equivalence classes with the quotient topology. Then \mathcal{R} is homeomorphic to the 2–sphere. The fundamental group of M acts on \mathcal{R} by homeomorphisms. There is a natural topology in $\widetilde{M} \cup \mathcal{R}$ making it into a compactification of \widetilde{M} . The action of $\pi_1(M)$ on \widetilde{M} extends to an action on $\widetilde{M} \cup \mathcal{R}$. The quotient map from $\partial\mathcal{O} (\cong \mathbf{S}^1)$ to $\mathcal{R} (\cong \mathbf{S}^2)$ is a group invariant Peano curve associated to the flow Φ . All of this uses only the dynamics of the flow Φ .*

If x in $\partial\mathcal{O}$ is an ideal point of (say) a stable leaf in \mathcal{O}^s , then the condition of no perfect fits implies that no unstable leaf has ideal point x . Hence if k is the maximum number of prongs in singular leaves of \mathcal{O}^s (or \mathcal{O}^u), then any equivalence class has at most k points.

Our goal is to relate the flow ideal compactification with well known objects in three manifold topology. We have actions of $\pi_1(M)$ on a circle ($\partial\mathcal{O}$) and a sphere (\mathcal{R}). Motivated by a lot of previous work in 2– and 3–dimensional topology, one asks whether such actions are convergence group actions. For example a group that acts as a uniform convergence group on the circle is topologically conjugate to a Moebius group [\[63; 32; 18\]](#) with fundamental consequences for 3–manifold theory [\[32; 18\]](#). Also a fundamental question of Cannon [\[15\]](#) asks whether a uniform convergence group acting on a 2–sphere is conjugate to a cocompact Kleinian group. This is related to the geometrization of 3–manifolds.

A compactum is a compact Hausdorff space. A group Γ acts as a *convergence group* on a metrizable compactum Z if for any sequence $(\gamma_n)_{n \in \mathbf{N}}$ of distinct elements in Γ , there is a subsequence $(\gamma_{n_i})_{i \in \mathbf{N}}$ and a source/sink pair y, x so that $(\gamma_{n_i}(t))_{i \in \mathbf{N}}$ converges uniformly to the constant map with value x in compact sets of $Z - \{y\}$; see Gehring and Martin [\[37\]](#). Notice that x, y may be the same point. This is equivalent to Γ acting properly discontinuously on the set of distinct triples $\Theta_3(Z)$ of elements of Z ; see Tukia [\[64\]](#) and Bowditch [\[8\]](#). In addition the action is *uniform* if the quotient

of $\Theta_3(Z)$ by the action is compact. If Z is perfect (no isolated points) then the additional condition is equivalent to every point of Z being a conical limit point for the action. A point x in Z is a *conical limit point* if there is a sequence $(\gamma_n)_{n \in \mathbb{N}}$ in Γ and b, c distinct in Z , with $\gamma_n(x)$ converging to c but for every other point y in Z then $(\gamma_n(y))$ converges to b .

The action of $\pi_1(M)$ on $\partial\mathcal{O}$ is not a convergence action. Here is the proof: Let g nontrivial in $\pi_1(M)$ so that g fixes a point x in \mathcal{O} . Equivalently g is associated to a periodic orbit of Φ . Up to taking a power assume that g leaves invariant all prongs of $\mathcal{O}^s(x), \mathcal{O}^u(x)$. Hence it fixes the points in $\partial\mathcal{O}$ which are the ideal points of these prongs. We show in this article that all these ideal points are distinct points of the circle. In addition the fixed points alternate between contracting and expanding fixed points for g . Now consider the sequence (g^n) acting on $\partial\mathcal{O}$. The above facts imply that all elements in this sequence of distinct elements of $\pi_1(M)$ (or any subsequence) will share more than 2 fixed points and hence the sequence (g^n) does not have a single source/sink pair. Hence the action of $\pi_1(M)$ on $\partial\mathcal{O}$ is not a convergence group action.

Main Theorem *Let Φ be a pseudo-Anosov flow without perfect fits, not topologically conjugate to a suspension Anosov flow. Let \mathcal{R} be the associated flow ideal boundary with corresponding compactification $\tilde{M} \cup \mathcal{R}$ of the universal cover. Then the action of $\pi_1(M)$ on \mathcal{R} is a uniform convergence group. In addition the action of $\pi_1(M)$ on $\tilde{M} \cup \mathcal{R}$ is a convergence group.*

The main part of the proof is to prove uniform convergence action on \mathcal{R} . Here 1–dimensional dynamics (action on the circle $\partial\mathcal{O}$) completely encodes the 2–dimensional dynamics (action on \mathcal{R}). A lot of the proof can be done using only this interplay and the action on the 2–dimensional space \mathcal{O} , but as expected the 3–dimensional setting of the flow $\tilde{\Phi}$ in the universal cover of M needs to be used in some crucial steps.

To prove the convergence group property, we break into three cases up to subsequences: (1) every γ_n is associated to a singular orbit of Φ , (2) every γ_n is associated to a nonsingular closed orbit of Φ , (3) every γ_n acts freely on \mathcal{O} . For example consider case (2). Up to taking squares, the action of γ_n in $\partial\mathcal{O}$ immediately has 4 fixed points, associated to the two ideal points of the stable leaf of the periodic orbit and the two unstable ones. By dynamics of pseudo-Anosov flows, the stable points are locally attracting for the action of γ_n on $\partial\mathcal{O}$ and the unstable ones are locally repelling. When there are no perfect fits, this carries over to the whole of $\partial\mathcal{O}$. As the 2 ideal points of a stable leaf are identified in \mathcal{R} , this produces a source/sink behavior for (powers of) one γ_n . An extended analysis shows the source/sink behavior for sequences. The uniform property of the action is achieved by showing that every point of \mathcal{R} is a conical limit point. The proofs of these results are very involved.

To prove the fact about the action on $\tilde{M} \cup \mathcal{R}$, consider a sequence of distinct elements $(\gamma_n)_{n \in \mathbb{N}}$ of $\pi_1(M)$. At this point we will already know that up to subsequence it has a source/sink pair y, x for the action restricted to \mathcal{R} . We then show that y, x is a source sink pair for the action on $\tilde{M} \cup \mathcal{R}$. This depends on a careful analysis of neighborhoods in $\tilde{M} \cup \mathcal{R}$ of points in \mathcal{R} . The harder case is when such a point comes from an ideal point of a leaf of \mathcal{O}^s or \mathcal{O}^u . The [Main Theorem](#) implies in particular that the action of $\pi_1(M)$ on \mathcal{R} (or on $\partial\mathcal{O}$) is minimal.

We mention that when there are perfect fits it is not at all clear what the resulting structure of the quotient space \mathcal{R} is. For example consider Φ an \mathbf{R} -covered Anosov flow; see Fenley [21]. There are infinitely many examples where M is hyperbolic [21]. In this case the quotient \mathcal{R} (of the circle $\partial\mathcal{O}$) as defined in [Theorem B](#), is a union of a circle and two special points: each special point is nonseparated from every point in the circle [21; 61]. Hence \mathcal{R} is not even metrizable. Clearly in this case the quotient \mathcal{R} does not provide the expected ideal boundary of \tilde{M} (which is a sphere).

This finishes the topological/dynamical systems part of the article. In the remainder of the article we use the excellent properties of \mathcal{R} and $\tilde{M} \cup \mathcal{R}$ to relate them with the large scale geometry of the manifold. This has geometric consequences for the fundamental group of the manifold and also for flows and foliations. In particular we give an entirely new proof that the fundamental group of closed, atoroidal 3-manifolds that fiber over the circle is Gromov hyperbolic.

The key tool will be the following: Bowditch [7], following ideas of Gromov, proved the very interesting theorem that if Γ acts as a uniform convergence group on a perfect, metrizable compactum Z , then Γ is Gromov hyperbolic, Z is homeomorphic to the Gromov ideal boundary $\partial\Gamma$ and the action on Z is equivariantly topologically conjugate to the action of Γ on its Gromov ideal boundary. This is a true geometrization theorem (in the sense of groups): the hypothesis are entirely topological on the group action and there is a strong geometric conclusion. The [Main Theorem](#) then immediately implies the following:

Theorem D *Let Φ be a pseudo-Anosov flow without perfect fits, not topologically conjugate to a suspension Anosov flow. Let \mathcal{R} be the associated flow ideal boundary of \tilde{M} and $\tilde{M} \cup \mathcal{R}$ the flow ideal compactification. Then $\pi_1(M)$ is Gromov hyperbolic and the action of $\pi_1(M)$ on \mathcal{R} is topologically conjugate to the action on the Gromov ideal boundary S_∞^2 . In addition the actions on $\tilde{M} \cup \mathcal{R}$ and $\tilde{M} \cup S_\infty^2$ are also topologically conjugate by a homeomorphism which is the identity in \tilde{M} .*

It was known that the Gromov boundary of $\pi_1(M)$ is a sphere by Bestvina and Mess [5] because M is irreducible. To prove the last statement of [Theorem D](#): Let ξ be the

bijection between $\widetilde{M} \cup \mathcal{R}$ and $\widetilde{M} \cup S_\infty^2$, which is the identity in \widetilde{M} and the conjugacy of the actions in \mathcal{R} . Clearly this is group equivariant. We show that the bijection ξ is continuous. This follows from the convergence group action properties for the action on $\widetilde{M} \cup \mathcal{R}$ plus the conjugacy between the actions on \mathcal{R} and S_∞^2 . **Theorem D** means that the constructions of this article can be seen as a dynamical systems analogue to Gromov's geometric constructions in the case of this class of pseudo-Anosov flows.

A few remarks are in order here. In **Theorem D**, the result that $\pi_1(M)$ is Gromov hyperbolic is not new and also follows from a result of Gabai and Kazez [35] and additional work. The reason is: if M with a pseudo-Anosov flow is toroidal, then either there is a free homotopy between closed orbits of the flow or the flow is topologically conjugate to a suspension Anosov flow by Fenley [27]. The last option is disallowed by hypotheses of **Theorem D**. If there is a free homotopy between closed orbits then there are perfect fits, again by Fenley [24; 25]. Hence the hypothesis of **Theorem D** imply that M is atoroidal. With further analysis using the topological theory of pseudo-Anosov flows [24; 25] one can then show that Φ has singular orbits. Therefore the (singular) stable foliation blows up to an essential lamination which is genuine, so [35] implies that $\pi_1(M)$ is Gromov hyperbolic. Gabai and Kazez showed that least area disks in M satisfy a linear isoperimetric inequality. The proof of this last fact uses the ubiquity theorem for semi-Euclidean laminations of Gabai [34]. This is a deep but very mysterious result. In particular it provides no direct relationship with the Gromov ideal boundary.

The important new feature of **Theorem D** is that it relates the flow structure with the large scale geometric structure. Our construction gives a very explicit description of the Gromov ideal boundary of \widetilde{M} – first as a purely dynamical systems object and a posteriori implying that $\pi_1(M)$ is Gromov hyperbolic and totally relating the two ideal boundaries. In particular this is a new approach to obtain Gromov hyperbolicity. There are several important geometric consequences. First we obtain a new proof of a classical result:

Corollary E *Let Φ be a suspension pseudo-Anosov flow with at least a singular orbit in a closed 3-manifold M . Then $\pi_1(M)$ is Gromov hyperbolic.*

This theorem has two well known proofs: the original by Thurston [62] and a later proof by Bestvina and Feighn [4]. Thurston's original proof uses quasiconformal maps, Kleinian groups and the double limit theorem and obviously proves much more – it proves that M admits a hyperbolic metric. Bestvina and Feighn's proof is a geometric group theory proof and introduces the extremely useful condition of flaring annuli. Our proof is entirely new in the sense that it uses dynamical systems and convergence groups via Bowditch's theorem.

The proof of [Corollary E](#) is as follows: Let S be a cross section of Φ . Since there is a singularity of Φ , S is a hyperbolic surface. We already mentioned that the orbit space of $\tilde{\Phi}$ is identified with the universal cover \tilde{S} and the foliations $\mathcal{O}^s, \mathcal{O}^u$ in \mathcal{O} are identified with lifts \tilde{f}^s, \tilde{f}^u of the stable and unstable foliations of the monodromy of the fibration. According to [Theorem D](#) all that is needed is to prove that there are no perfect fits. Notice that this is a topological condition. We will check this for \tilde{f}^s, \tilde{f}^u . Consider S with a hyperbolic metric, hence \tilde{S} is the hyperbolic plane. If there is a perfect fit between \tilde{f}^s and \tilde{f}^u , then there is a ray l of (say) \tilde{f}^s so that if s_n is a sequence of unstable leaves (of \tilde{f}^u) intersecting l and with $l \cap s_n$ escaping to the appropriate end of l then s_n does not escape compact sets in \tilde{S} and converges to a leaf s of \tilde{f}^u . Now use the fundamental property that leaves of \tilde{f}^s, \tilde{f}^u are uniform quasigeodesics in \tilde{S} ; see Thurston [60] and Fathi, Laudenbach and Poenaru [20]. It follows that s is unique and that l, s have a common ideal point in $\partial\tilde{S}$. This is impossible [60; 20]. This finishes the proof of [Corollary E](#).

As a remark for future reference, the case of pseudo-Anosov flows without perfect fits shares many features with the suspension pseudo-Anosov situation: the property alluded above about ideal points of l and s has an analogue for general pseudo-Anosov flows without perfect fits. This is the content of the escape lemma ([Lemma 4.4](#)). The escape lemma is extremely useful for the analysis of pseudo-Anosov flows without perfect fits.

We should remark that if M is closed, irreducible, aspherical, atoroidal and with infinite fundamental group then Perelman's results [54; 55; 56] show that M is hyperbolic. We do not make use of Perelman's results here. We stress again that a fundamental goal of this article is to analyze which geometric information can be obtained solely from dynamical systems constructions.

We now describe other very important geometric consequences of [Theorem D](#). Flow objects (flowlines, stable/unstable leaves, foliations transverse to the flow) behave very well in the compactification $\tilde{M} \cup \mathcal{R}$. Since this is homeomorphic to the Gromov compactification, it is natural to expect that these objects also have good geometric properties. First we study metric properties of such flows and their stable/unstable foliations. In manifolds with Gromov hyperbolic fundamental group the relation between objects in \tilde{M} and their limit sets is extremely important (see Thurston [58; 59; 62], Gromov [40], Ghys and de la Harpe [38] and Coornaert, Delzant and Papadopoulos [19]) and is related to the large scale geometry in \tilde{M} . A flow in M is *quasigeodesic* if flow lines in \tilde{M} are uniformly efficient in measuring ambient distance up to a bounded multiplicative distortion [58; 40; 38; 19]. It implies that each flow line is a bounded distance from the corresponding geodesic which has the same ideal points. Quasigeodesic flows are very useful; see Cannon and Thurston [16], Mosher [47; 48]

and Fenley [22]. Usually it is very hard to show that a flow is quasigeodesic and there is no general construction of quasigeodesic flows in hyperbolic manifolds – the known class of examples is relatively small. **Theorem D** provides a powerful way to obtain quasigeodesic flows:

Theorem F *Let Φ be a pseudo-Anosov flow without perfect fits. Then Φ is a quasigeodesic flow in M . In addition Λ^s, Λ^u are quasi-isometric singular foliations in M .*

First assume that Φ is not topologically conjugate to a suspension Anosov flow. By **Theorem D**, $\pi_1(M)$ is Gromov hyperbolic. To prove **Theorem F** we first prove some properties in the flow compactification $\tilde{M} \cup \mathcal{R}$: (1) Each flow line γ of $\tilde{\Phi}$ has a unique forward ideal point γ_+ in \mathcal{R} and a backward ideal point γ_- . (2) For each γ the points γ_-, γ_+ are distinct. (3) The forward (backward) ideal point map is continuous. **Theorem D** conjugates the action in $\tilde{M} \cup \mathcal{R}$ to the action in $\tilde{M} \cup S_\infty^2$, hence the same properties are true in $\tilde{M} \cup S_\infty^2$. A previous result of the author and Mosher [29] then implies that Φ is quasigeodesic.

Quasi-isometric behavior for Λ^s, Λ^u means that leaves of $\tilde{\Lambda}^s$ (or $\tilde{\Lambda}^u$) are uniformly efficient in measuring distance in \tilde{M} [58; 40; 19]. This is the analogue of quasigeodesic behavior in the two-dimensional setting and again it is extremely useful [40; 58; 59; 62]. For example it implies that leaves of $\tilde{\Lambda}^s, \tilde{\Lambda}^u$ are quasiconvex [58; 40]. Quasi-isometric foliations are very useful [16; 61; 25; 28]. To prove the second part of **Theorem F**: the lack of perfect fits implies that the leaf spaces of $\tilde{\Lambda}^s, \tilde{\Lambda}^u$ are Hausdorff [24; 25]. Together with the fact that Φ is quasigeodesic this now implies that Λ^s, Λ^u are quasi-isometric foliations [25]. This provides a new way to obtain quasi-isometric singular foliations in such manifolds.

If now Φ is topologically conjugate to a suspension Anosov flow, then quasigeodesic behavior of Φ and quasi-isometric behavior of Λ^s, Λ^u are easy to prove.

Finally we apply these results to (nonsingular) foliations and their asymptotic properties and we show that pseudo-Anosov flows without perfect fits are very common. A foliation \mathcal{F} in a 3-manifold is **R**-covered if the leaf space \mathcal{H} of $\tilde{\mathcal{F}}$ is Hausdorff or equivalently homeomorphic to the real numbers. **R**-covered foliations are very common [42; 21; 61; 9]. On the other hand if \mathcal{H} is not Hausdorff then it is a simply connected, non-Hausdorff, 1-dimensional manifold with a countable basis [3]. Hence it is orientable. The nonseparated points in \mathcal{H} correspond to branching in the negative (positive) direction if they are separated on their positive (negative) sides. A foliation \mathcal{F} has one sided branching if the branching in $\tilde{\mathcal{F}}$ is only in one direction (positive or negative).

If \mathcal{F} is a Reebless foliation in M^3 aspherical with $\pi_1(M)$ Gromov hyperbolic then each leaf F of $\widetilde{\mathcal{F}}$ is uniformly Gromov hyperbolic in its path metric and has an ideal circle $\partial_\infty F$ compactifying it to a closed disk $F \cup \partial_\infty F$. The *continuous extension question* asks what is the asymptotic behavior of the leaves of $\widetilde{\mathcal{F}}$, that is, do they approach the ideal boundary S_∞^2 in a continuous way? This is formulated as follows: Does the inclusion $i: F \rightarrow \widetilde{M}$ extend continuously to $i: F \cup \partial_\infty F \rightarrow \widetilde{M} \cup S_\infty^2$? If so then i restricted to $\partial_\infty F$ is a continuous parametrization of the limit set of F , which will be locally connected. When this happens for all leaves of $\widetilde{\mathcal{F}}$, we say that \mathcal{F} has the continuous extension property [33; 16; 25]. This property is very hard to prove.

We use the geometric tools developed in this article to prove the following theorem. For any codimension one \mathbf{R} -covered foliation \mathcal{F} if it is not transversely orientable there is a transversely orientable lift \mathcal{F}_2 in a double cover M_2 of M . If \mathcal{F} is transversely orientable we abuse notation and let $M_2 = M$ and $\mathcal{F}_2 = \mathcal{F}$. If M is aspherical and atoroidal then the author [26] and Calegari [10] proved that there is a pseudo-Anosov flow Φ which is transverse to \mathcal{F}_2 in M_2 .

Theorem G *Let \mathcal{F} be an \mathbf{R} -covered foliation in an aspherical, atoroidal 3-manifold M . The pseudo-Anosov flow Φ transverse to the transversely oriented foliation \mathcal{F}_2 associated to \mathcal{F} does not have perfect fits and is not conjugate to a suspension Anosov flow. It follows that Φ is quasigeodesic by [Theorem F](#) and this in turn implies that \mathcal{F}_2 satisfies the continuous extension property. This trivially implies that \mathcal{F} satisfies the continuous extension property. In addition the stable/unstable foliations of Φ (in the cover M_2) are quasi-isometric.*

The aspherical property is used only to get rid of a manifold which is finitely covered by $\mathbf{S}^2 \times \mathbf{S}^1$. The problem is that the \mathbf{R} -covered property does not imply that the foliation is Reebless. For example consider the foliation \mathcal{F} of $\mathbf{S}^2 \times \mathbf{S}^1$ which is obtained by gluing two Reeb components appropriately. If one is careful, then \mathcal{F} is \mathbf{R} -covered. On the other hand the author previously proved that if \mathcal{F} is \mathbf{R} -covered, but not Reebless, then M is finitely covered by $\mathbf{S}^2 \times \mathbf{S}^1$ [28]. Apart from this special case, the universal cover is homeomorphic to \mathbf{R}^3 and the results of the author and Calegari can be applied.

The continuous extension property was previously proved for: (1) fibrations in the seminal work of Cannon and Thurston [16], (2) finite depth foliations and some other classes by the author [25; 28], (3) slitherings or uniform foliations by Thurston [61]. The methods of the proof were very different from those in this article – in all of the previous cases one always had a strong geometric property to start with. For example in the case of finite depth foliations (not fibrations), the compact leaf is quasi-isometrically embedded and therefore quasiconvex. After some work this implies that the almost

transverse pseudo-Anosov flow is quasigeodesic. After substantial more work this implies the continuous extension property for the foliation. The problem in general is that for instance in an arbitrary \mathbf{R} -covered foliation, the leaves have no good geometric property to start with, so these methods do not work. In this article we obtain geometric properties for the flow directly and solely from the dynamics of the pseudo-Anosov flow and this can then be applied to the foliations. **Theorem G** implies the previous results for fibrations and slitherings. **Theorem G** produces new examples of quasigeodesic flows and quasi-isometric foliations.

In order to prove **Theorem G** assume that \mathcal{F} is transversely oriented and start with a pseudo-Anosov flow Φ transverse to \mathcal{F} as constructed in [26; 10]. We show that Φ is not conjugate to a suspension Anosov flow and has no perfect fits. By **Theorem F**, the flow Φ is quasigeodesic and its stable/unstable foliations are quasi-isometric. By previous results [28], it follows that \mathcal{F} has the continuous extension property.

We also consider foliations with one sided branching and prove:

Theorem H *Let \mathcal{F} be a foliation with one sided branching in M^3 aspherical, atoroidal. Then \mathcal{F} is transverse to a pseudo-Anosov flow Φ without perfect fits and not conjugate to a suspension Anosov flow. It follows that Φ is quasigeodesic, its stable/unstable foliations are quasi-isometric and \mathcal{F} has the continuous extension property. If F is a leaf of $\widetilde{\mathcal{F}}$, then the limit set of F is not the whole sphere.*

Under the conditions of this theorem, Calegari [11] proved that \mathcal{F} is transverse to a pseudo-Anosov flow Φ . We show that such Φ does not have perfect fits nor is conjugate to a suspension Anosov flow. By **Theorem F**, the flow Φ is quasigeodesic. This implies that \mathcal{F} has the continuous extension property. The last statement follows from metric properties of leaves of $\widetilde{\Lambda}^s, \widetilde{\Lambda}^u$.

The geometric applications obtained here (Theorems **F**, **G** and **H** and **Corollary E**) were the main motivation for the construction of the flow ideal boundary of \widetilde{M} and the ideal circle of \mathcal{O} .

The open case for the continuous extension question is contained in the case when \mathcal{F} branches in both directions. The case of finite depth foliations was resolved very recently in [28] using work of Mosher and the author [49; 50; 29]. For general foliations with two sided branching, Calegari [12] constructed a very full lamination transverse to \mathcal{F} , like the stable/unstable foliation of a flow. It is possible that in certain situations there are 2 laminations, which perhaps are transverse to each other and these can be possibly blown down to produce a pseudo-Anosov flow transverse or almost transverse to \mathcal{F} [49; 50]. When the ideal dynamics of the case of a pseudo-Anosov flow with perfect fits is better understood, then Calegari's results could be very useful.

The geometric properties of flows and foliations (Theorems [F](#), [G](#) and [H](#)) are proved at the end of the article, in Sections [6](#) and [7](#). The proofs use the [Main Theorem](#), [Theorem D](#) and previous results. Theorems [G](#), [H](#) provide a large class of examples of pseudo-Anosov flows without perfect fits and also quasigeodesic flows and quasi-isometric foliations. The bulk of the article is proving [Theorem A](#) in [Section 3](#), [Theorem B](#) and the [Main Theorem](#) in [Section 4](#). Gromov hyperbolicity and conjugacy are proved in [Section 5](#).

How to read this article The body of the article has two main parts: (1) [Section 3](#) studies the ideal boundary of \mathcal{O} and (2) [Section 4](#) studies the flow ideal boundary for flows without perfect fits and uniform convergence group action. For those mainly interested in the geometric results (Sections [4–7](#)) we highlight in [Section 3](#) where the case without perfect fits has simplified proofs.

Acknowledgements We thank Lee Mosher who told us about Bowditch’s theorem. We also thank the reviewer who did an outstanding job of very carefully checking the whole article and who had innumerable useful comments, many detailed suggestions and corrections which were incorporated in this article.

2 Preliminaries: Pseudo-Anosov flows

Given M let $\tilde{M} \rightarrow M$ be a fixed universal cover.

Let Φ be a flow on a closed 3-manifold M . We say that Φ is a *pseudo-Anosov flow* if the following are satisfied:

- For each $x \in M$, the flow line $t \rightarrow \Phi(x, t)$ is C^1 , it is not a single point, and the tangent vector bundle $D_t\Phi$ is C^0 .
- There is a finite number of periodic orbits $\{\gamma_i\}$, called *singular orbits*, such that the flow is “topologically” smooth off of the singular orbits (see below).
- The flowlines of Φ are contained in two possibly singular 2-dimensional foliations Λ^s, Λ^u satisfying: Outside of the singular orbits, the foliations Λ^s, Λ^u are not singular, they are transverse to each other and their leaves intersect exactly along the orbits of Φ . A leaf containing a singularity is homeomorphic to $P \times I/f$ where P is a p -prong in the plane and f is a homeomorphism from $P \times \{1\}$ to $P \times \{0\}$. We restrict to p at least 2, that is, we do not allow 1-prongs.
- In a stable leaf all orbits are forward asymptotic, in an unstable leaf all orbits are backwards asymptotic.

Basic references for pseudo-Anosov flows are [\[47; 49; 50\]](#).

Notation/Definition The singular foliations lifted to \tilde{M} are denoted by $\tilde{\Lambda}^s, \tilde{\Lambda}^u$. If x is a point in M let $W^s(x)$ denote the leaf of Λ^s containing x . Similarly one defines $W^u(x)$ and in the universal cover $\tilde{W}^s(x), \tilde{W}^u(x)$. If α is an orbit of Φ , similarly define $W^s(\alpha), W^u(\alpha)$, etc.... Let also $\tilde{\Phi}$ be the lifted flow to \tilde{M} .

We review the results about the topology of $\tilde{\Lambda}^s, \tilde{\Lambda}^u$ that we will need. We refer to our previous work [24; 25] for detailed definitions, explanations and proofs. Proposition 4.2 of [29] shows that the orbit space of $\tilde{\Phi}$ in \tilde{M} is homeomorphic to the plane \mathbf{R}^2 . This orbit space is denoted by $\mathcal{O} \cong \tilde{M}/\tilde{\Phi}$. Let $\Theta: \tilde{M} \rightarrow \mathcal{O} \cong \mathbf{R}^2$ be the projection map. If L is a leaf of $\tilde{\Lambda}^s$ or $\tilde{\Lambda}^u$, then $\Theta(L) \subset \mathcal{O}$ is a tree which is either homeomorphic to \mathbf{R} if L is regular, or is a union of k rays all with the same starting point if L has a singular k -prong orbit. The foliations $\tilde{\Lambda}^s, \tilde{\Lambda}^u$ induce singular 1-dimensional foliations $\mathcal{O}^s, \mathcal{O}^u$ in \mathcal{O} . Its leaves are the $\Theta(L)$'s as above. If L is a leaf of $\tilde{\Lambda}^s$ or $\tilde{\Lambda}^u$, then a *sector* is a component of $\tilde{M} - L$. Similarly for $\mathcal{O}^s, \mathcal{O}^u$. If B is any subset of \mathcal{O} , we denote by $B \times \mathbf{R}$ the set $\Theta^{-1}(B)$. The same notation $B \times \mathbf{R}$ will be used for any subset B of \tilde{M} : it will just be the union of all flow lines through points of B . If x is a point of \mathcal{O} , then $\mathcal{O}^s(x)$ (resp. $\mathcal{O}^u(x)$) is the leaf of \mathcal{O}^s (resp. \mathcal{O}^u) containing x .

Definition 2.1 Let L be a leaf of $\tilde{\Lambda}^s$ or $\tilde{\Lambda}^u$. A *slice leaf* of L is $l \times \mathbf{R}$ where l is a properly embedded copy of the real line in $\Theta(L)$. For instance if L is regular then L is its only slice leaf. If a slice leaf is the boundary of a sector of L then it is called a *line leaf* of L . If a is a ray in $\Theta(L)$ then $A = a \times \mathbf{R}$ is called a *half leaf* of L . If ζ is an open segment in $\Theta(L)$ it defines a *flow band* L_1 of L by $L_1 = \zeta \times \mathbf{R}$.

Important convention In general a slice leaf is just a slice leaf of some L in $\tilde{\Lambda}^s$ or $\tilde{\Lambda}^u$ and so on. We also use the terms slice leaves, line leaves, perfect fits, lozenges and rectangles for the projections of these objects in \tilde{M} to the orbit space \mathcal{O} .

If $F \in \tilde{\Lambda}^s$ and $G \in \tilde{\Lambda}^u$ then F and G intersect in at most one orbit. Also suppose that a leaf $F \in \tilde{\Lambda}^s$ intersects two leaves $G, H \in \tilde{\Lambda}^u$ and so does $L \in \tilde{\Lambda}^s$. Then F, L, G, H form a *rectangle* in \tilde{M} and there is no singularity of $\tilde{\Phi}$ in the interior of the rectangle; see [24, pages 637–638]. There will be two generalizations of rectangles: (1) perfect fits, that is in the orbit space properly embedded rectangles with one corner removed and (2) lozenges, that is, rectangle with two opposite corners removed.

Definition 2.2 (Perfect fits [22; 24]) Two leaves $F \in \tilde{\Lambda}^s$ and $G \in \tilde{\Lambda}^u$, form a perfect fit if $F \cap G = \emptyset$ and there are half leaves F_1 of F and G_1 of G and also flow bands $L_1 \subset L \in \tilde{\Lambda}^s$ and $H_1 \subset H \in \tilde{\Lambda}^u$, so that the set

$$\bar{F}_1 \cup \bar{H}_1 \cup \bar{L}_1 \cup \bar{G}_1$$

separates M and the joint structure of $\tilde{\Lambda}^s, \tilde{\Lambda}^u$ in a complementary component R is that of a rectangle as above without one corner orbit. Specifically, a stable leaf intersects H_1 if and only if it intersects G_1 and similarly for unstable leaves intersecting F_1, L_1 .

Refer to Figure 1(a) for perfect fits. We also say that the leaves F, G *almost intersect*.

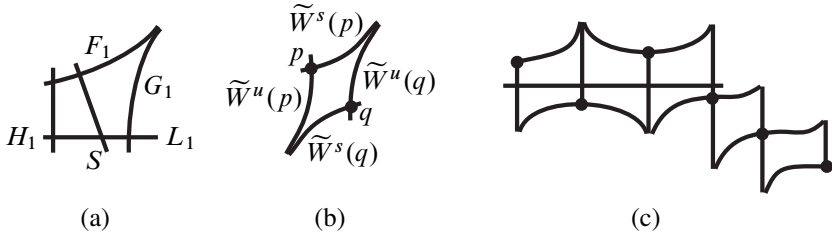

Figure 1. (a) Perfect fits in \tilde{M} (b) A lozenge (c) A chain of lozenges

Definition 2.3 [22; 24] A *lozenge* is an open region of \tilde{M} whose closure in \tilde{M} is homeomorphic to a rectangle with two corners removed. More specifically two orbits $\alpha = \tilde{\Phi}_R(p), \beta = \tilde{\Phi}_R(q)$ form the corners of a lozenge if there are half leaves A, B of $\tilde{W}^s(\alpha), \tilde{W}^u(\alpha)$ defined by α and C, D half leaves of $\tilde{W}^s(\beta), \tilde{W}^u(\beta)$ so that A and D form a perfect fit and so do B and C . The region in \tilde{M} bounded by A, B, C, D is the lozenge R and it does not have any singularities. See Figure 1(b).

This is Definition 4.4 of [25]. The sets A, B, C, D are the sides of the lozenge. There may be singular orbits on the sides of the lozenge and the corner orbits. Two lozenges are *adjacent* if they share a corner and there is a stable or unstable leaf intersecting both of the lozenges; see Figure 1(c). Therefore they share a side. A *chain of lozenges* is a collection $\{C_i\}, i \in I$, of lozenges where I is an interval (finite or not) in \mathbf{Z} , so that if $i, i + 1 \in I$, then C_i and C_{i+1} share a corner; see Figure 1(c). Consecutive lozenges may be adjacent or not. The chain is finite if I is finite.

Definition 2.4 Suppose A is a flow band in a leaf of $\tilde{\Lambda}^s$. Suppose that for each orbit γ of $\tilde{\Phi}$ in A there is a half leaf B_γ of $\tilde{W}^u(\gamma)$ defined by γ so that: for any two orbits γ, β in A then a stable leaf intersects B_β if and only if it intersects B_γ . This defines a stable product region S which is the union of the B_γ . Similarly define unstable product regions.

The main property of product regions is the following (see [25, page 641]): for any $F \in \tilde{\Lambda}^s, G \in \tilde{\Lambda}^u$ so that (i) $F \cap S \neq \emptyset$ and (ii) $G \cap S \neq \emptyset$, then $F \cap G \neq \emptyset$. There are no singular orbits of $\tilde{\Phi}$ in S .

We abuse convention and say that a leaf L of $\tilde{\Lambda}^s$ or $\tilde{\Lambda}^u$ is *periodic* if there is a nontrivial covering translation g of \tilde{M} with $g(L) = L$. This is equivalent to $\pi(L)$ containing a periodic orbit of Φ , which may or may not be singular. In the same way, an orbit γ of $\tilde{\Phi}$ is *periodic* if $\pi(\gamma)$ is a periodic orbit of Φ . Finally a leaf l of \mathcal{O}^s or \mathcal{O}^u is periodic if there is $g \neq \text{id}$ in $\pi_1(M)$ with $g(l) = l$.

We say that two orbits γ, α of $\tilde{\Phi}$ (or the leaves $\tilde{W}^s(\gamma), \tilde{W}^s(\alpha)$) are connected by a chain of lozenges $\{\mathcal{C}_i\}$, $1 \leq i \leq n$, if γ is a corner of \mathcal{C}_1 and α is a corner of \mathcal{C}_n . If a lozenge \mathcal{C} has corners β, γ and if g in $\pi_1(M) - \text{id}$ satisfies $g(\beta) = \beta$, $g(\gamma) = \gamma$ (and so $g(\mathcal{C}) = \mathcal{C}$), then $\pi(\beta), \pi(\gamma)$ are closed orbits of Φ which are freely homotopic to the inverse of each other.

Theorem 2.5 [25, Theorem 4.8] *Let Φ be a pseudo-Anosov flow in M closed and let $F_0 \neq F_1 \in \tilde{\Lambda}^s$. Suppose that there is a nontrivial covering translation g with $g(F_i) = F_i, i = 0, 1$. Let $\alpha_i, i = 0, 1$ be the periodic orbits of $\tilde{\Phi}$ in F_i so that $g(\alpha_i) = \alpha_i$. Then α_0 and α_1 are connected by a finite chain of lozenges $\{\mathcal{C}_i\}$, $1 \leq i \leq n$, and g leaves invariant each lozenge \mathcal{C}_i as well as their corners.*

The leaf space of $\tilde{\Lambda}^s$ (or $\tilde{\Lambda}^u$) is usually not a Hausdorff space. Two points of this space are nonseparated if they do not have disjoint neighborhoods in the respective leaf space. The main result concerning non-Hausdorff behavior in the leaf spaces of $\tilde{\Lambda}^s, \tilde{\Lambda}^u$ is the following:

Theorem 2.6 [25, Theorem 4.9] *Let Φ be a pseudo-Anosov flow in M^3 . Suppose that $F \neq L$ are not separated in the leaf space of $\tilde{\Lambda}^s$. Then F and L are periodic. Let F_0, L_0 be the line leaves of F, L which are not separated from each other. Let V_0 be the sector of F bounded by F_0 and containing L . Let α be the periodic orbit in F_0 and H_0 be the component of $(\tilde{W}^u(\alpha) - \alpha)$ contained in V_0 . Let g be a nontrivial covering translation with $g(F_0) = F_0, g(H_0) = H_0$ and g leaves invariant the components of $(F_0 - \alpha)$. Then $g(L_0) = L_0$. This produces closed orbits of Φ which are freely homotopic in M . Theorem 2.5 then implies that F_0 and L_0 are connected by a finite chain of lozenges $\{A_i\}$, $1 \leq i \leq n$, consecutive lozenges are adjacent. They all intersect a common stable leaf C . There is an even number of lozenges in the chain; see Figure 2. In addition let $\mathcal{B}_{F,L}$ be the set of leaves of $\tilde{\Lambda}^s$ nonseparated from F and L . Put an order in $\mathcal{B}_{F,L}$ as follows: The set of orbits of C contained in the union of the lozenges and their sides is an interval. Put an order in this interval. If $R_1, R_2 \in \mathcal{B}_{F,L}$ let α_1, α_2 be the respective periodic orbits in R_1, R_2 . Then $\tilde{W}^u(\alpha_i) \cap C \neq \emptyset$ and let $a_i = \tilde{W}^u(\alpha_i) \cap C$. We define $R_1 < R_2$ in $\mathcal{B}_{F,L}$ if a_1 precedes a_2 in the order of the set of orbits of C . Then $\mathcal{B}_{F,L}$ is either order isomorphic to $\{1, \dots, n\}$ for some $n \in \mathbf{N}$; or $\mathcal{B}_{F,L}$ is order isomorphic to the integers \mathbf{Z} . In addition if there are $Z, S \in \tilde{\Lambda}^s$ so*

that $\mathcal{B}_{Z,S}$ is infinite, then there is an incompressible torus in M transverse to Φ . In particular M cannot be atoroidal. Also if there are F, L as above, then there are closed orbits α, β of Φ which are freely homotopic to the inverse of each other. Finally up to covering translations, there are only finitely many non-Hausdorff points in the leaf space of $\tilde{\Lambda}^s$.

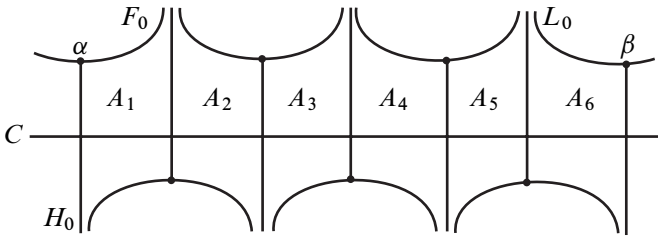

Figure 2. The correct picture between nonseparated leaves of $\tilde{\Lambda}^s$

Notice that $\mathcal{B}_{F,L}$ is a discrete set in this order. For detailed explanations and proofs, see [24; 25].

Scalloped regions Suppose that $\mathcal{E} = \{E_i \mid i \in \mathbf{Z}\}$ is a bi-infinite collection of leaves of $\tilde{\Lambda}^s$ or $\tilde{\Lambda}^u$ all of which are nonseparated from each other and ordered as in Theorem 2.6. There is an associated structure in \tilde{M} or \mathcal{O} , which is called a scalloped region, which we now describe. Let $\{A_i \mid i \in \mathbf{Z}\}$ be the bi-infinite collection of lozenges associated to \mathcal{E} – consecutive A_i ’s are adjacent. For simplicity assume that \mathcal{E} is a collection of stable leaves, so that every A_i intersects a fixed stable leaf ζ . The A_i are chosen so that each E_i has a half leaf in the boundary of A_{2i} and another half leaf in the boundary of A_{2i-1} . Each leaf E_i contains a periodic orbit γ_i . Let W_i be the half leaf of $\tilde{W}^u(\gamma_i)$ which is in the boundary of both A_{2i} and A_{2i-1} . In addition since A_{2i} and A_{2i+1} are also adjacent there is a stable leaf G_i which has half leaves in the closure of each of A_{2i} and A_{2i+1} . Hence $\{G_i \mid i \in \mathbf{Z}\}$ is another collection of leaves of $\tilde{\Lambda}^s$ nonseparated from each other. Each G_i contains a periodic orbit δ_i and $\tilde{W}^u(\delta_i)$ has a half leaf Y_i which is in the closure of both A_{2i} and A_{2i+1} . The scalloped region associated to \mathcal{E} is

$$\mathcal{S} = \bigcup_{i \in \mathbf{Z}} (A_i \cup W_i \cup Y_i)$$

(see Figure 3).

Scalloped regions were introduced for Anosov flows in [23, Section 5, Theorem 5.2], but the same analysis works for pseudo-Anosov flows, mainly because there can be no

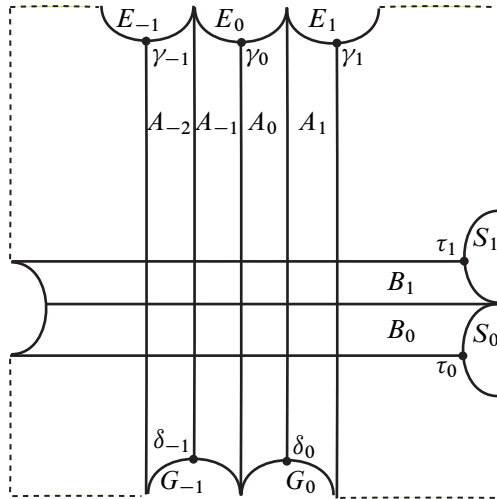

Figure 3. A scalloped region \mathcal{S} . The collections $\{E_i\}_{i \in \mathbf{Z}}$, $\{G_i\}_{i \in \mathbf{Z}}$ of stable leaves are part of the boundary of \mathcal{S} . In addition $\{S_i\}_{i \in \mathbf{Z}}$ are unstable leaves in the boundary of \mathcal{S} . For better viewing we indent a few of the nonseparated leaves in (say) $\{E_i\}_{i \in \mathbf{Z}}$ into the square. Similarly for $\{G_i\}$, $\{S_i\}$.

singularities in the lozenges [24]. It is proved in [23] that such a scalloped region \mathcal{S} (where the E_i are stable leaves) is also the union of another bi-infinite collection of lozenges $\{B_i \mid i \in \mathbf{Z}\}$ and stable half leaves in the boundary of pairs of consecutive lozenges. All of the lozenges B_i intersect a fixed *unstable* leaf. Therefore the foliations $\tilde{\Lambda}^s, \tilde{\Lambda}^u$ restricted to \mathcal{S} form a product structure in \mathcal{S} , they both have leaf space which is homeomorphic to \mathbf{R} . In this way the boundary $\partial\mathcal{S}$ also has two bi-infinite collections of leaves of \mathcal{O}^u . In each collection all leaves are nonseparated from each other. Let $\{S_j\}_{j \in \mathbf{Z}}$ be the collection which is in the limit of the sequence $\tilde{W}^u(\gamma_i)$ (or equivalently $\tilde{W}^u(\delta_i)$) when i converges to plus infinity. The other bi-infinite collection of unstable leaves is obtained as the limit of $(\tilde{W}^u(\gamma_i))$ as i converges to minus infinity. We may choose the indexing of the $\{S_j\}$ so that S_j has one half leaf in the closure of B_{2j} and another in the closure of B_{2j-1} . Let τ_j be the periodic orbit in S_j . We may also choose the indexing so $(\tilde{W}^s(\tau_j))$ converges to the collection $\{E_i\}_{i \in \mathbf{Z}}$ when $i \rightarrow \infty$ and $(\tilde{W}^s(\tau_j))$ converges to $\{G_i\}_{i \in \mathbf{Z}}$ when $i \rightarrow -\infty$. We also call a scalloped region the projection of \mathcal{S} to the orbit space \mathcal{O} .

Here is an actual model for a scalloped region in \mathcal{O} . Let I, J be two properly embedded, order preserving images of \mathbf{Z} into $(-1, 1)$ which are intercalated, for example $J = \{\pm(1 - 1/(2n)) \mid n \geq 1\}$ and $I = \{\pm(1 - 1/(2n - 1)) \mid n \geq 1\}$. The

closure of a scalloped region is a proper embedding of the set

$$V = ([-1, 1] \times [-1, 1]) - ((J \times \{1\}) \cup (\{1\} \times J) \cup (I \times \{-1\}) \cup (\{-1\} \times I) \cup (\{-1, 1\} \times \{-1, 1\}))$$

into \mathcal{O} satisfying the following conditions: The horizontal and vertical foliations of \mathbf{R}^2 restricted to V are mapped to the stable and unstable foliations in $\bar{\mathcal{S}}$. The interior of V maps to the scalloped region. It is crucial that I, J do not intersect. For example the stable leaf $(-1/2, 1/2) \times \{1\}$ is one of the E_i , we may assume that it is E_0 . Then $(0, 1)$ is the periodic orbit γ_0 and $\{0\} \times (-1, 1)$ is the half leaf of $\widetilde{W}^u(\gamma_0)$ which is in the boundary of the lozenges $A_{-1} = (-1/2, 0) \times (-1, 1)$ and $A_0 = (0, 1/2) \times (-1, 1)$. It is crucial in this particular example that $(0, -1)$ is *not* in V . We may assume that $S_0 = \{1\} \times (-1/2, 1/2)$.

In [Figure 3](#) we indent the region along the boundary stable and unstable leaves to highlight that they form collections of nonseparated leaves.

Theorem 2.7 [[25](#), Theorem 4.10] *Let Φ be a pseudo-Anosov flow. Suppose that there is a stable or unstable product region. Then Φ is topologically conjugate to a suspension Anosov flow. In particular Φ is nonsingular.*

3 Ideal boundaries of pseudo-Anosov flows

Let Φ be a pseudo-Anosov flow in M . The orbit space \mathcal{O} of $\widetilde{\Phi}$ (the lifted flow to \widetilde{M}) is homeomorphic to \mathbf{R}^2 [[29](#)]. In this section we construct a natural compactification of \mathcal{O} with an ideal circle $\partial\mathcal{O}$ called the ideal boundary of the pseudo-Anosov flow. We put a topology in $\mathcal{D} = \mathcal{O} \cup \partial\mathcal{O}$ making it homeomorphic to a closed disk. The induced action of $\pi_1(M)$ on \mathcal{O} extends to an action on $\mathcal{O} \cup \partial\mathcal{O}$. This works for any pseudo-Anosov flow in a 3-manifold – no metric, or topological assumptions (such as atoroidal) on M or on the flow Φ . In addition there are no assumptions about perfect fits for Φ or concerning topological conjugacy to suspension Anosov flows.

One key aspect here is that we want to use only the foliations $\mathcal{O}^s, \mathcal{O}^u$ to define $\partial\mathcal{O}$ and its topology.

Before formally defining ideal points of \mathcal{O} we analyze some examples. Given g in $\pi_1(M)$ it acts on \widetilde{M} and sends flow lines of $\widetilde{\Phi}$ to flow lines and hence acts on \mathcal{O} . This action preserves the foliations $\widetilde{\Lambda}^s, \widetilde{\Lambda}^u, \mathcal{O}^s, \mathcal{O}^u$. Recall that a 2-dimensional foliation \mathcal{F} in a 3-manifold N is called \mathbf{R} -covered if the leaf space of $\widetilde{\mathcal{F}}$ is homeomorphic to the real line [[21](#)]. An Anosov flow is \mathbf{R} -covered if Λ^s (or equivalently Λ^u [[11](#)]) is \mathbf{R} -covered.

(1) Ideal boundary for \mathbf{R} -covered Anosov flows: The product case A product Anosov flow is an Anosov flow for which both Λ^s, Λ^u are \mathbf{R} -covered and in addition every leaf of \mathcal{O}^s intersects every leaf of \mathcal{O}^u and vice versa [21; 1]. Barbot proved that this implies that Φ is topologically conjugate to a suspension [1]. Every ray in \mathcal{O}^s or \mathcal{O}^u generates a point of $\partial\mathcal{O}$ and they are all distinct. Furthermore there are 4 additional ideal points corresponding to escaping quadrants in \mathcal{O} ; see Figure 4(a). The quadrants are bounded by a ray in \mathcal{O}^u and a ray in \mathcal{O}^s which intersect only in their common starting point (or finite endpoints). In this case it is straightforward to put a topology in $\mathcal{D} = \mathcal{O} \cup \partial\mathcal{O}$ so that it is a closed disk and covering transformations act on the extended object. If Λ^s, Λ^u are both transversely orientable, then any covering translation g fixes the 4 distinguished points. It is associated to a periodic orbit if and only if it fixes 4 additional ideal points: if x in \mathcal{O} satisfies $g(x) = x$, then g fixes the “ideal points” of rays of $\mathcal{O}^s(x), \mathcal{O}^u(x)$. When Λ^s, Λ^u are not transversely orientable, there are other restricted possibilities.

We want to define a topology in \mathcal{D} using only the structure of $\mathcal{O}^s, \mathcal{O}^u$ in \mathcal{O} . A distinguished ideal point p has a neighborhood basis determined by (say nested) pairs of rays in $\mathcal{O}^s, \mathcal{O}^u$ intersecting at their common finite endpoint and so that the corresponding quadrants “shrink” to p . For an ordinary ideal point p , say a stable ideal point of a ray in $\mathcal{O}^s(x)$, we can use shrinking strips: the strips are bounded by 2 rays in \mathcal{O}^s and a segment in \mathcal{O}^u connecting the endpoints of the rays. The unstable segment intersects the original stable ray of $\mathcal{O}^s(x)$ and the intersections escape in that ray and also shrink in the transversal direction. Already in this case this leads to an important concept:

Definition 3.1 (Polygonal path) A polygonal path in \mathcal{O} is a properly embedded, bi-infinite path ζ in \mathcal{O} satisfying: either ζ is a leaf of \mathcal{O}^s or \mathcal{O}^u or ζ is the union of a finite collection l_1, \dots, l_n of segments and rays in leaves of \mathcal{O}^s or \mathcal{O}^u so that l_1 and l_n are rays in \mathcal{O}^s or \mathcal{O}^u and the other l_i are finite segments. We require that l_i intersects l_j if and only if $|i - j| \leq 1$. In addition the l_i are alternatively in \mathcal{O}^s and \mathcal{O}^u . The number n is the length of the polygonal path. The points $l_i \cap l_{i+1}$ are the vertices of the path. The edges of ζ are the $\{l_i\}$.

In the product \mathbf{R} -covered case, the exceptional ideal points need neighborhoods basis formed by polygonal paths of length 2 and all the others need polygonal paths of length 3.

(2) \mathbf{R} -covered Anosov flows: Skewed case This is an Anosov flow so that Λ^s, Λ^u are \mathbf{R} -covered and the following is satisfied: Topologically the orbit space \mathcal{O} is homeomorphic to $(0, 1) \times \mathbf{R}$, a subset of the plane, so that stable leaves are horizontal

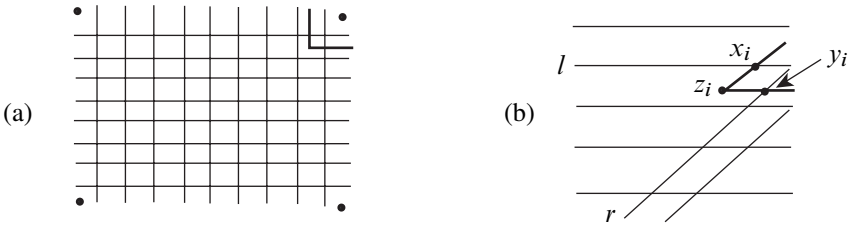

Figure 4. Ideal points for product \mathbf{R} -covered Anosov flow. The dots represent the 4 special points. (b) The picture in skewed case

segments and unstable leaves are segments making a constant angle $\neq \pi/2$ with the horizontal; see Figure 4(b). A leaf of \mathcal{O}^s does not intersect every leaf of \mathcal{O}^u and vice versa [21; 2]. Here again each ray of \mathcal{O}^s or \mathcal{O}^u defines an ideal point of \mathcal{O} . However as is intuitive from the picture, rays of $\mathcal{O}^s, \mathcal{O}^u$ which form a perfect fit in \mathcal{O} should define the same ideal point of \mathcal{O} . In addition to these ideal points of rays of leaves in \mathcal{O}^s or \mathcal{O}^u , there should be 2 distinguished ideal points – one from the “positive” direction of \mathbf{R} and one from the “negative” direction of \mathbf{R} . Hence \mathcal{D} is equal to $[0, 1] \times \mathbf{R}$ union two points: one for the positive end of \mathbf{R} and one for the negative end. Put a topology in \mathcal{D} so that $[0, 1] \times \mathbf{R}$ is homeomorphic to a disk minus two boundary points. Covering translations act as homeomorphisms of this disk. A transformation without fixed points in \mathcal{O} fixes only the 2 distinguished ideal points in $\partial\mathcal{O}$, one attracting and another repelling. If a transformation g has a fixed point p in \mathcal{O} , then it leaves invariant the leaf $l = \mathcal{O}^s(p)$ of \mathcal{O}^s . If g switches the components of $l - \{p\}$, then g does not fix any point in $\partial\mathcal{O}$. Otherwise there are infinitely many fixed points; see [21; 2].

A neighborhood basis of the distinguished ideal points can be obtained from leaves of \mathcal{O}^s or \mathcal{O}^u which escape in that direction (positive or negative). For nondistinguished ideal points, we get sequences of polygonal paths of length 2 escaping every compact set and “converging” to this ideal point; see Figure 4(b). More precisely if rays l, r of $\mathcal{O}^s, \mathcal{O}^u$ respectively form a perfect fit defining the ideal point p , then choose x_i in l and escaping in the direction of the perfect fit and similarly chose y_i in r . Consider the polygonal path of length two containing rays in the stable leaf through y_i and the unstable leaf through x_i intersecting in z_i ; see Figure 4(b).

(3) Suspension pseudo-Anosov flows: Singular case The fiber is a hyperbolic surface. The orbit space \mathcal{O} is identified with the universal cover of the fiber which is metrically the hyperbolic plane \mathbf{H}^2 . There is a natural ideal boundary S^1_∞ , the circle at infinity of \mathbf{H}^2 . One expects that $\partial\mathcal{O}$ and S^1_∞ should be equivalent. But the construction of S^1_∞ uses the *metric* structure on the surface – in general there is no metric structure

in \mathcal{O} , so again we want to define $\partial\mathcal{O}$ using only the structure of $\mathcal{O}^s, \mathcal{O}^u$. From a geometric point of view, there are some points of S_∞^1 which are ideal points of rays of leaves of \mathcal{O}^s or \mathcal{O}^u . But there are many other points in S_∞^1 . The foliations $\mathcal{O}^s, \mathcal{O}^u$ can be split into geodesic laminations (of \mathbf{H}^2) which have only complementary regions which are finite sided ideal polygons. This implies that given p in S_∞^1 there is always a sequence of leaves l_i (in \mathcal{O}^s or \mathcal{O}^u) which is nested, escapes to infinity and “shrinks” to the ideal point p . In this way one can characterize all points of S_∞^1 using only the foliations $\mathcal{O}^s, \mathcal{O}^u$ and hence $\partial\mathcal{O} = S_\infty^1$ in this case. Also $\mathcal{O}^s, \mathcal{O}^u$ define a topology in $\mathcal{O} \cup \partial\mathcal{O}$ compatible with the metric topology.

Now we analyze a potential difficulty. Let l be a nonsingular ray (say) in \mathcal{O}^s and let x_i in l , forming a nested sequence of points in l , escaping compact sets in l . For simplicity assume that the leaves g_i of \mathcal{O}^u through x_i are nonsingular. We would like to say that the sequence (g_i) “defines” an ideal point of \mathcal{O} . If the g_i escape compact sets in \mathcal{O} , then this will be the case. However it is not always true that (g_i) escapes in \mathcal{O} . If they do not escape in \mathcal{O} , then they limit on a collection of unstable leaves $\{h_j \mid j \in J\}$. But there is one of them, call it h which makes a perfect fit with l on that side of l . This nontrivial fact is proved in [24]. The perfect fit l, h is the obstruction to leaves g_i escaping in \mathcal{O} .

We need a couple of definitions. A *quarter* at z is a component of $\mathcal{O} - (\mathcal{O}^s(z) \cup \mathcal{O}^u(z))$. If z is nonsingular there are exactly 4 quarters, if z is a k -prong point there are $2k$ quarters.

Definition 3.2 (Convex polygonal paths) A polygonal path δ in \mathcal{O} is convex if there is a complementary region V of δ in \mathcal{O} so that at any given vertex z of δ the local region of V near z is not a quarter at z . Let $\tilde{\delta} = \mathcal{O} - (\delta \cup V)$. This region $\tilde{\delta}$ is the convex region of \mathcal{O} associated to the convex polygonal path δ .

The definition implies that if the region $\tilde{\delta}$ contains 2 endpoints of a segment in a leaf of \mathcal{O}^s or \mathcal{O}^u , then it contains the entire segment (proved later). This is why δ is called convex. If δ is a single nonsingular leaf of $\tilde{\Lambda}^s$ or $\tilde{\Lambda}^u$ or if all the vertices of δ are singularities, then it is possible that there are two regions $\tilde{\delta}$ which are convex. In the future the context will make clear which region we are considering. If δ is a polygonal path, V a complementary region and p a vertex for which V is a quarter at p , then p is called a nonconvex vertex of $\mathcal{O} - (\delta \cup V)$.

Definition 3.3 (Equivalent rays) Two rays l, r of $\mathcal{O}^s, \mathcal{O}^u$ are *equivalent* if there is a finite collection of distinct rays $l_i, 1 \leq i \leq n$, alternatively in $\mathcal{O}^s, \mathcal{O}^u$ so that $l = l_0, r = l_n$ and l_i forms a perfect fit with l_{i+1} for $1 \leq i < n$.

It is important to notice that this is strictly about rays in $\mathcal{O}^s, \mathcal{O}^u$ and not leaves of $\mathcal{O}^s, \mathcal{O}^u$. More specifically we want consecutive perfect fits to be in the same rays of the adjoining leaf. This implies for instance that if $n \geq 3$ then for all $1 \leq i \leq n - 2$ the leaves l_i and l_{i+2} are nonseparated from each other in the respective leaf space.

Definition 3.4 (Admissible sequences of paths) An admissible sequence of polygonal paths in \mathcal{O} is a sequence of convex polygonal paths $(v_i)_{i \in \mathbb{N}}$ so that the associated convex regions \tilde{v}_i form a nested sequence of subsets of \mathcal{O} , which escapes compact sets in \mathcal{O} and for any i , the two rays at the ends of v_i are not equivalent.

The fact that the \tilde{v}_i are nested and escape compact sets in \mathcal{O} implies that the \tilde{v}_i are uniquely defined given the v_i .

Structure of this section The construction of the ideal compactification of \mathcal{O} and the analysis of its properties is very involved and complex. This will take all of this very long section, so here is an outline of the section: Ideal points of \mathcal{O} will be defined by admissible sequences of polygonal paths, [Definition 3.10](#). But many admissible sequences generate the same ideal point, so we first define a relation in the set of admissible sequences, [Definition 3.5](#). We establish a technical result called the fundamental lemma ([Lemma 3.6](#)) which implies that the relation above is an equivalence relation, [Lemma 3.7](#). In [Definition 3.10](#) we define ideal points of \mathcal{O} producing $\partial\mathcal{O}$ and with union $\mathcal{D} = \mathcal{O} \cup \partial\mathcal{O}$. Some special ideal points are defined in [Definition 3.8](#) associated to ideal points of rays of \mathcal{O}^s or \mathcal{O}^u and in [Lemma 3.27](#) we deal with infinitely many leaves of \mathcal{O}^s or \mathcal{O}^u all nonseparated from each other. Not every admissible sequence is efficient to study ideal points of \mathcal{O} and we define master sequences in [Definition 3.11](#): roughly the rays in the polygonal paths of these sequences approach the ideal point of \mathcal{O} from “both” sides. In [Lemma 3.13](#) we prove that any ideal point admits a master sequence and they are used to distinguish points of $\partial\mathcal{O}$. In [Definition 3.15](#) we define a topology for $\mathcal{D} = \mathcal{O} \cup \partial\mathcal{O}$ and in [Lemma 3.16](#) we prove that this is indeed a topology in \mathcal{D} . We then progressively prove stronger properties of \mathcal{D} : [Lemma 3.19](#) shows that \mathcal{D} is Hausdorff, [Lemma 3.23](#) shows that \mathcal{D} is first countable and [Lemma 3.24](#) shows that \mathcal{D} is second countable – this last one is a bit more complicated than the other ones. These and the structure of \mathcal{D} quickly imply that \mathcal{D} is regular ([Lemma 3.25](#)) and hence metrizable. Then we study compactness properties: first we prove a technical and very tricky lemma about a special case ([Lemma 3.28](#)). This lemma considerably simplifies the proof of compactness of \mathcal{D} ([Proposition 3.29](#)). At this point we can quickly prove that the ideal boundary $\partial\mathcal{O}$ is homeomorphic to a circle ([Proposition 3.30](#)). We then prove a harder result ([Theorem 3.31](#)) that $\mathcal{D} = \mathcal{O} \cup \partial\mathcal{O}$ is homeomorphic to a closed disk. Finally in Lemmas

3.20, 3.22, 3.27 and Proposition 3.33 we prove additional properties of the ideal points of \mathcal{O} and which types of admissible sequences are associated to different types of ideal points.

An ideal point of \mathcal{O} will be determined by an admissible sequence of paths. Clearly this does not work for suspension Anosov flows because a sequence of escaping leaves of \mathcal{O}^s approaches infinitely many different ideal points. Hence such flows are special and are treated separately. We abuse notation and say that $(v_i)_{i \in \mathbb{N}}$ is nested. For notational simplicity many times we denote such a sequence by (v_i) .

Two different admissible sequences may define the same ideal point and we first need to decide when two such sequences are equivalent. At first it seems that any 2 sequences associated to the same ideal point of \mathcal{O} would have to be eventually nested with each other. However it is easy to see that such is not the case. For example consider a nested sequence of rays of a fixed leaf l . We will later see how to extend each ray on one side of l to form an admissible sequence. Extend them also to the other side to form another admissible sequence. Intuitively the two sequences should converge to the intrinsic ideal point of l , but clearly they are not eventually nested.

Definition 3.5 Given two admissible sequences of chains $C = (c_i)$, $D = (d_i)$, we say that C is smaller or equal than D , denoted by $C \leq D$, if: for any i there is $k_i > i$ so that $\tilde{c}_{k_i} \subset \tilde{d}_i$. Two admissible sequences of chains $C = (c_i)$, $D = (d_i)$ are equivalent and we then write $C \cong D$ if there is a third admissible sequence $E = (e_i)$ so that $C \leq E$ and $D \leq E$.

Ideal points of \mathcal{O} will be defined as equivalence classes of admissible sequences of polygonal paths. Hence we must prove that \cong is an equivalence class and along the way we derive several other properties. We should stress that the requirement that the chains are *convex* is fundamental for the whole discussion. It is easy to see in the skewed \mathbf{R} -covered Anosov case, that given any two distinct ideal points p, q on the “same side” of the distinguished ideal points, the following happens: Let l, r be stable rays defining p, q respectively. Then there is a sequence of polygonal paths in \mathcal{O} , that escapes compact sets in \mathcal{O} and so that each \tilde{c}_i contains subrays of both l and r . The polygonal paths can be chosen to satisfy all the properties, except that they are convex. On the other hand convexity does imply important properties as shown in the next lemma. This key lemma will be used throughout this section. After this lemma we show that \cong is an equivalence relation.

Singular foliations in surfaces with boundary and index formula Let \mathcal{F} be a singular foliation on a compact surface S with boundary, so that interior singularities

are all of k -prong type and $k \geq 3$. The foliation may be tangent to part of the boundary. There is an Euler–Poincaré index formula so that the sum of the indices of the singularities equals the Euler characteristic of the surface. An interior singularity with k prongs has index $1 - \frac{k}{2}$. A boundary singularity has index $\frac{1}{2} - \frac{k}{2} - \frac{t}{4}$, where k is the number of prongs going into the surface and t is the number of prongs which are part of the boundary. The possible values of t are 0, 1, 2. For example if $k = 0, t = 0$ the singularity is half of a center, which has index 1/2. This will be used for compact subsets of \mathcal{O} , which are foliated by \mathcal{O}^s or \mathcal{O}^u .

Lemma 3.6 (Fundamental lemma) *Assume that Φ is not topologically conjugate to a suspension Anosov flow. Let l, r be rays of \mathcal{O}^s or \mathcal{O}^u , which are not equivalent. Then there is no pair of admissible sequences of polygonal paths $E = (e_i), F = (f_i)$ so that $\tilde{e}_i \cap \tilde{f}_i \neq \emptyset$ (for all i) and $\tilde{e}_i \cap r \neq \emptyset, \tilde{f}_i \cap l \neq \emptyset$, for all i .*

Proof We assume that both l and r are rays of \mathcal{O}^s , other cases are treated similarly. By taking subrays if necessary, we may assume that l, r are disjoint, have no singularities and miss a compact set containing the base point in \mathcal{O} . Join the initial points of l, r by an arc α' missing this big compact set to produce a properly embedded bi-infinite curve $\alpha = l \cup \alpha' \cup r$; see Figure 5(b). Let V be the component of $\mathcal{O} - \alpha$ which misses the basepoint.

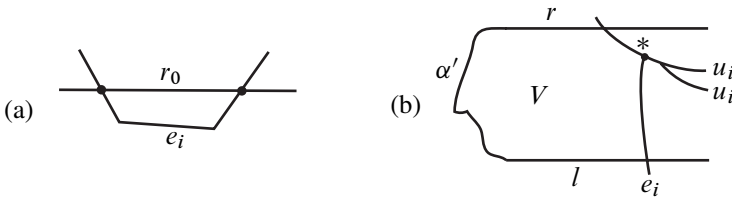

Figure 5. (a) Convexity implies connected intersection of r and B_i . (b) All rays of u_i stay in V forever. There is a nonconvex vertex at $*$.

Case 1 $E = F$.

Here we have to show that there is no admissible sequence of polygonal paths $E = (e_i)$ such that \tilde{e}_i always intersects l and r . This implies that the phenomenon described above (in the skewed Anosov flow case) for nonconvex polygonal paths cannot happen for convex polygonal paths. Suppose this is not true and let $E = (e_i)$ be one such sequence. Let $B_i = \tilde{e}_i \cup e_i$.

Claim 1 *If e_i is a convex polygonal path with region \tilde{e}_i and r is a leaf of \mathcal{O}^s (or of \mathcal{O}^u), then $(\tilde{e}_i \cup e_i) \cap r$ is connected.*

Otherwise there is a compact subarc r_0 of r with ∂r_0 in e_i and the rest of e_i contained in $\mathcal{O} - B_i$; see Figure 5(a). There is a compact arc τ in e_i joining the endpoints x, y of r_0 . Let D be the disc in \mathcal{O} bounded $r_0 \cup \tau$ and consider the foliation \mathcal{O}^s induced in D . The singularities in the interior are k prong type all with negative index. At x there is a boundary prong of \mathcal{O}^s (since r_0 is in the boundary of D) so the index is $\leq 1/4$ and similarly for y . If there are singularities in the interior of r_0 then they have negative index as r_0 is contained in a leaf of \mathcal{O}^s . Since the Euler characteristic of the disc is 1 and there are no half centers in τ , all singularities in τ have index $\leq 1/4$. It follows that there must be at least *two* boundary singularities in $\tau - \{x, y\}$ with index $1/4$. Each one of these has to be a point z so that there is a prong of \mathcal{O}^s and a prong of \mathcal{O}^u locally contained in $\tau \subset \partial D$ and no other prongs of $\mathcal{O}^s \cup \mathcal{O}^u$ entering D . The unstable prong is transverse to \mathcal{O}^s . This shows there is a quarter of D at z . But since $r_0 - \{x, y\} \subset (\mathcal{O} - B_i)$ this means that \tilde{e}_i has a nonconvex vertex at z , contradiction to e_i being convex. Therefore $B_i \cap r$ is connected and this proves Claim 1. This is the convexity property of \tilde{e}_i mentioned after Definition 3.2.

We continue the analysis of Case 1. Notice that $(B_j \cap r)_{j \in \mathbb{N}}$ is a nested family of nonempty sets in r . Since B_j escapes compact sets as $j \rightarrow \infty$ and $B_j \cap r$ is connected, it follows that $B_j \cap r$ is a subray of r for any j . If $e_j \cap r$ contains a nontrivial segment, then again by convexity and Euler characteristic it follows that $\tilde{e}_j \cap r = \emptyset$ contradiction. Hence e_i intersects r in a single point. Let $u'_i = \mathcal{O}^u(e_i \cap r)$ be the unstable leaf through the intersection. Up to subsequence, we may assume no two u'_i are the same.

Since r has no singularities there are two components of $u'_i - (u'_i \cap r)$. There is only one of them denoted by u_i which locally enters V at the intersection; see Figure 5(b). There are two subcases:

Case 1.a Some ray of u_i stays in V for all time.

Let this ray be s . Then s is properly embedded in V and together with a subray of r it bounds a subregion W of V . It follows that by taking a bigger i if necessary we may assume that all rays of u_i stay in V forever, because they are in the region W above. Take the ray s of u_i starting at $u'_i \cap r$ and farthest from r or equivalently closest to l . Even though r, l are rays and do not separate \mathcal{O} , this makes sense because V is an open disc with boundary α and l, r are disjoint subrays of α . All rays of u_i start in r and the collection of rays of u_i is (weakly) nested.

In that case, in order for e_i to reach l it leaves s at a point $*$ where e_i switches to travel along a segment t in \mathcal{O}^s . There cannot be any other prong of $\mathcal{O}^s(*) \cup \mathcal{O}^u(*)$ not in \tilde{e}_i : since s is an unstable prong and t is contained in a stable prong, there would have to be another unstable prong in \tilde{e}_i . But this unstable prong is contained in V by

construction and hence not contained in \tilde{e}_i . Hence this shows that $*$ is a nonconvex vertex in e_i ; see Figure 5(b). This is a contradiction to e_i convex.

Case 1.b For any i , all rays of u_i exit V .

We first want to show that the sequence u_i does not escape compact sets in \mathcal{O} . Then we show that a leaf u in the limit of (u_i) has a ray which makes a perfect fit with r and we restart the proof with u, l in place of the rays r, l .

Suppose first that all u_i intersect l . In that case let z_i be the part of u_i between l and r . If the z_i escapes compact sets in \mathcal{O} , then the region between l and r is an unstable product region as in Definition 2.4. Theorem 2.7 then implies that Φ is topologically conjugate to a suspension Anosov flow. This is disallowed by hypothesis (in fact the lemma fails for product \mathbf{R} -covered Anosov flows). Hence the u_i does not escape compact sets in \mathcal{O} . The other option is that the u_i does not intersect l , hence they intersect α' . Since α' is compact, then in all cases u_i does not escape compact sets in \mathcal{O} .

The intersection of \bar{u}_i with r escapes in r , and (u_i) is a nested collection (as subsets of V), so u_i converges to a collection of (line) leaves of \mathcal{O}^u . Let u be one of the limit leaves. Consider the set B of unstable leaves nonseparated from u and which are either contained in V or intersect α . By Theorem 2.6 there is an order in the set B and there are only finitely many unstable leaves between any given u and r , so we may assume that u is the leaf in B which is the closest one to r in terms of this order.

Claim 2 u makes a perfect fit with r .

Suppose that u does not make a perfect fit with r . We will produce a product region. Let z a point in u . The stable leaf through z intersects u_i for a fixed i big. For any other w in u then $\mathcal{O}^s(w)$ intersects u_j for some $j > i$. We say that w is closer to r than z if the intersections $\mathcal{O}^s(z) \cap u_j, \mathcal{O}^s(w) \cap u_j, \bar{u}_j \cap r$ are linearly ordered in u'_j . Hence $\mathcal{O}^s(w)$ also intersects the fixed u_i . It follows that as w escapes in u in the direction of r , the $\mathcal{O}^s(w)$ converge to a stable leaf r' which makes a perfect fit with u . Hence r, r' are distinct. The region between r, r' is a product region because all the u_j ($j \geq i$) intersect r, r' and there are no limit leaves of the (u_j) between r, r' . As seen above, this would imply Φ is topologically conjugate to a suspension Anosov flow, contradiction. This proves Claim 2.

The rest of Case 1 concerns only flows with perfect fits.

We now show that u is not contained in V . If u is contained in V , there are two cases: (i) $u \subset \tilde{e}_i$ for all i , but this contradicts that \tilde{e}_i escapes compact sets of \mathcal{O} ; (ii)

there is an i with u not contained in \tilde{e}_i . But then e_i has to cross u , and since u is contained in V , then e_i has to cross u again in order to intersect l . This produces two intersections of e_i with u , which is disallowed by [Claim 1](#).

It follows that there is a ray of u exiting V . We now restart the argument with u, l instead of r, l . The same arguments as above produce a line leaf v_1 of \mathcal{O}^s making a perfect fit with u and v_1 exiting V . In addition v_1 is nonseparated from r in the leaf space of \mathcal{O}^s , because of the perfect fits $r \rightarrow u \rightarrow v_1$. Now iterate to obtain v_2, v_3, \dots . This is a nested collection and the sequence v_j cannot accumulate anywhere in \mathcal{O} , since v_k, v_{k+2} are nonseparated from each other in the corresponding leaf space. In addition no two consecutive unstable leaves in the sequence can intersect l as they are nonseparated from each other. It follows that none of them intersect l and so they all intersect α' , which is compact. This contradicts the fact that they escape in \mathcal{O} . This proves that no escaping sequence of convex polygonal paths can always intersect both l and r . This finishes the analysis of Case 1.

Case 2 $E \neq F$.

Let r, l as in the statement of the lemma and suppose that $E = (e_i), F = (f_i)$ are admissible sequences with $\tilde{e}_i \cap \tilde{f}_i \neq \emptyset, r \cap \tilde{e}_i \neq \emptyset, l \cap \tilde{f}_i \neq \emptyset$, for all i . As before consider the region V bounded by l, r and an arc α' connecting them. By Case 1, \tilde{e}_i eventually stops intersecting l . Discarding the initial terms we can assume that $\tilde{e}_i \cap l = \emptyset$ and $\tilde{f}_i \cap r = \emptyset$ for all i .

We construct a polygonal path c_i as follows: first consider the part of e_i outside of V . Then add the edges (or pieces of edges) of e_i until it first meets f_i , then switch to f_i and follow along the rest of f_i in the direction that intersects l . There is only one such direction as f_i intersects l in a single point and notice that e_i does not intersect l . This path c_i separates \mathcal{O} and has a complementary component \tilde{c}_i which contains subrays of l, r . This component contains all of V except for a subset contained in a compact set of \mathcal{O} .

The vertices of c_i are all convex for \tilde{c}_i , except perhaps for the single vertex p_i where c_i changes from e_i to f_i . Once the nonconvex vertex appears, all subsequent vertices have to be convex.

As before consider the unstable leaf u_i through $e_i \cap r$. If some u_i has a ray which is entirely in V , then as seen in Case 1, for $j > i$ all rays of u_j which enter V must be entirely in V . This implies that the change from e_i to f_i has to be in u_i . Here is why: otherwise the next edge in c_i is w_i an edge still in e_i . But since c_i eventually has to cross l , and u_i is entirely contained in V , it follows that c_i has to intersect u_i twice. As seen in the proof of [Claim 1](#), this implies the existence of *two* nonconvex vertices in c_i . But c_i has only one nonconvex vertex, contradiction.

We conclude that all rays of u_i which enter V have to exit V . As seen in Case 1 they cannot escape compact sets in \mathcal{O} . They converge to a collection of (line) leaves in \mathcal{O}^u . As in Case 1, one of them, call it u makes a perfect fit with r . Since u, r make a perfect fit and \tilde{e}_i escapes compact sets, it follows that for i big e_i intersects u and the second edge of e_i is in leaves v_i of \mathcal{O}^s and v_i intersects u .

The first possibility here is that u is contained in V . Let W be the component of $\mathcal{O} - u$ contained in V . Since r, u make a perfect fit and $\tilde{f}_i \cap \tilde{e}_i \neq \emptyset$ it follows that \tilde{f}_i has to intersect W . Since $u \subset V$, then c_i has to intersect u twice – this is a contradiction as seen before. The second possibility is that u is not contained in V and intersects α . Notice that u is a ray equivalent to r . We can now restart the proof of Case 2 with u, l instead of r, l . The arguments above will produce a leaf v of \mathcal{O}^s making a perfect fit with u . Figure 6 illustrates the impossible situation that $v \subset V$. In that case some c_j

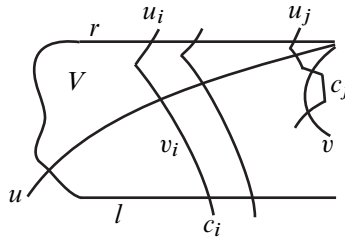

Figure 6. Two polygonal chains and perfect fits

is forced to have 2 nonconvex vertices. Hence v intersects α . As in Case 1, one can iterate this argument to arrive at a contradiction.

This finishes the proof of Lemma 3.6. □

Remarks If $A = (a_i)$ is an admissible sequence and $B = (a_{i_j})$ is a subsequence, then clearly B is also an admissible sequence and furthermore $A \leq B$ and $B \leq A$. It is also immediate from the nesting property that if $A = (a_i), C = (c_i)$ are admissible sequences, then the condition that $\tilde{a}_i \cap \tilde{c}_j \neq \emptyset$ for all i, j is equivalent to $\tilde{a}_i \cap \tilde{c}_i \neq \emptyset$ for all i .

Lemma 3.7 Suppose that Φ is not topologically conjugate to a suspension Anosov flow. Then the relation \cong is an equivalence relation for admissible sequences of polygonal paths.

Proof Clearly \cong is reflexive and symmetric. Suppose now that $A = (a_i), B = (b_i), C = (c_i)$ are admissible sequences of polygonal paths and $A \cong B, B \cong C$. Then there are $D = (d_i)$ with $A \leq D, B \leq D$ and $E = (e_i)$ with $B \leq E, C \leq E$. If for some i, j the \tilde{d}_i and \tilde{e}_j do not intersect this contradicts $B \leq D, B \leq E$.

Claim Let j be given. Then either there is $i > j$ with $\tilde{a}_i \subset \tilde{e}_j$ or there is $i > j$ with $\tilde{c}_i \subset \tilde{d}_j$.

Along the proof we may replace j by a bigger number – by the nesting property the result follows for the original j . The proof is by contradiction. So assume the claim fails. For each i , then $\tilde{a}_i \not\subset \tilde{e}_j$ and $\tilde{c}_i \not\subset \tilde{d}_j$. Clearly this implies that none of \tilde{d}_j, \tilde{e}_j is contained in the other. Define

$$Z' := \tilde{e}_j \cap \tilde{d}_j$$

This is an open subset of \mathcal{O} , which is noncompact as there is $m \geq j$ with $\tilde{b}_m \subset \tilde{e}_j \cap \tilde{d}_j$. It is conceivable that even though \tilde{d}_j, \tilde{e}_j are convex, Z' may not be connected. In any case let Z be the component of Z' containing \tilde{b}_m . Obviously Z is noncompact. Notice that ∂Z is made up of segments or rays in e_j or d_j . In addition ∂Z has at least two infinite rays because Z is noncompact. It is easy to prove that ∂Z is convex for Z because of this property for d_j, e_j .

We first deal with the following situation. Suppose that ∂Z has two bi-infinite components. Then e_j, d_j do not intersect and the region between d_j and e_j is equal to Z . Let α be an arc intersecting e_j, d_j only in its boundary. We can assume that α does not intersect \tilde{b}_m . Since (\tilde{d}_k) escapes compact sets in \mathcal{O} , then it eventually stops intersecting α , so choose $k > j$ with $\tilde{d}_k \cup d_k$ not intersecting α . If e_k does not intersect d_k , then either $\tilde{e}_k \subset \tilde{d}_k$ or $\tilde{d}_k \subset \tilde{e}_k$. This is because $\tilde{e}_k \subset \tilde{e}_j, \tilde{d}_k \subset \tilde{d}_j, \tilde{d}_k, \tilde{e}_k$ intersect and $d_k \cup \tilde{d}_k$ does not intersect α . Assume without loss of generality that $\tilde{e}_k \subset \tilde{d}_k$. Choose $i > k > j$ with $\tilde{c}_i \subset \tilde{e}_k$ which is a subset of \tilde{d}_k and hence of \tilde{d}_j . This proves the claim in this case.

Therefore by taking a bigger j if necessary we can assume that Z has only one bi-infinite boundary component. Let y_1, y_2 be the rays of d_j and z_1, z_2 be the rays of e_j . The bi-infinite component of ∂Z has two rays which are contained in $y_1 \cup y_2 \cup z_1 \cup z_2$. If there are subrays of both rays in this boundary ∂Z which are contained in $y_1 \cup y_2$, then it follows that $\tilde{d}_j \cup d_j - (\tilde{e}_j \cup e_j)$ is contained in a compact set in \mathcal{O} ; see Figure 7(a). Since the decreasing sequence $(\tilde{d}_k)_{k \in \mathbb{N}}$ of open sets in \mathcal{O} escapes compact sets in \mathcal{O} , then there would be k with $\tilde{d}_k \subset \tilde{e}_j$. But then there is i with $\tilde{a}_i \subset \tilde{d}_k \subset \tilde{e}_j$ and this would yield the claim in this case.

The remaining possibility to be analyzed is that one and only one boundary ray of ∂Z must be contained in $y_1 \cup y_2$ and one and only one boundary ray of ∂Z is in $z_1 \cup z_2$. This last fact also implies that if a boundary ray is contained in $y_1 \cup y_2$ then it cannot have a subray in $z_1 \cup z_2$. The argument here will be to produce two fixed rays r, l of \mathcal{O}^s or \mathcal{O}^u which always intersect \tilde{d}_i, \tilde{e}_i respectively and so that r, l are not equivalent. This will contradict the fundamental lemma.

Let l_j be the boundary ray of Z contained in $z_1 \cup z_2$. Then this ray is in $\tilde{d}_j \cup d_j$ and since it cannot have a subray contained in d_j it follows that it has a subray contained in \tilde{d}_j . It also follows that the other ray of e_j has to be eventually disjoint from \tilde{Z} . Similarly there is a ray r_j of d_j contained in \tilde{e}_j ; see Figure 7(b). Recall that $\tilde{b}_m \subset \tilde{d}_j \cap \tilde{e}_j$. Now consider $i \geq j$. If $\tilde{d}_i \subset \tilde{e}_j$ then we are done. Otherwise

$$\tilde{d}_i \cap \tilde{e}_j \neq \emptyset \quad \text{and} \quad \tilde{d}_i \not\subset \tilde{e}_j,$$

so the same analysis as above produces a ray of e_j contained in \tilde{d}_i . It can only be $l_j \cap \tilde{d}_i$ since the other ray of e_j is disjoint from $d_j \cup \tilde{d}_j$, so certainly disjoint from $d_i \cup \tilde{d}_i$. It now follows that for any $i \geq j$ there is a subray of the fixed ray l_j which is contained in \tilde{d}_i . Similarly for any $i \geq j$ there is a subray of the fixed r_j contained in \tilde{e}_i .

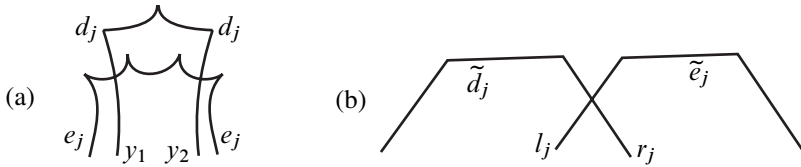

Figure 7. (a) The intersection of convex neighborhoods (b) Intersecting master sequences

The set $\tilde{d}_j \cap \tilde{e}_j$ has boundary which contains subrays of r_j, l_j . If r_j, l_j are equivalent rays then as there is i with $\tilde{b}_i \subset \tilde{e}_j \cap \tilde{d}_j$, the two rays of b_i would be equivalent, contradiction. Hence r_j, l_j are not equivalent. But for any $i \geq j$, then $\tilde{d}_i \cup \tilde{e}_i$ is a union of two convex regions containing subrays of l_j and r_j (j is fixed!). This is disallowed by the fundamental Lemma 3.6. This proves the claim.

Suppose then there are infinitely many j 's so that for each one of them, there is $i(j) > j$ with $\tilde{a}_{i(j)} \subset \tilde{e}_j$. Then for any k there is one such j with $j > k$ and so there is $i(j) > j$ with $\tilde{a}_{i(j)} \subset \tilde{e}_j \subset \tilde{e}_k$. This means that $A \leq E$ and so $A \cong C$. The claim shows that if this does not occur, then there are infinitely many j and for each such j there is $i(j) \geq j$ and $\tilde{c}_{i(j)} \subset \tilde{d}_j$. This now implies that $C \leq D$ and again $C \cong A$. This finishes the proof that \cong is an equivalence relation. \square

We first analyze admissible sequences associated to rays of \mathcal{O}^s or \mathcal{O}^u – each ray will define an ideal point of \mathcal{O} . Later we define general points of \mathcal{O} . We will be interested in the asymptotic behavior as points escape the ray to infinity. A ray does not separate \mathcal{O} , but still one can define sides of a ray as follows: let l be a ray of (say) \mathcal{O}^s . Fix a regular point p in l and consider the component W of $\mathcal{O} - \mathcal{O}^u(p)$

which contains a subray of l . Then $l \cap V$ separates V and we can talk about the sides of l in V . This depends only on the ray l and not on the point p .

Definition 3.8 (Standard sequences) Let l be a ray in \mathcal{O}^s or \mathcal{O}^u . For simplicity assume that it is in \mathcal{O}^s . Fix a side of l . Let d_i be a nested sequence of leaves of \mathcal{O}^u intersecting l with $d_i \cap l$ escaping l . If d_i escapes compact sets in \mathcal{O} then (d_i) is an admissible sequence which is called a standard sequence associated to l . If the d_i do not escape in \mathcal{O} , then they limit on a collection of unstable leaves. There is one of them, call it h which makes a perfect fit with l on the fixed side of l . Consider now e_i stable (nonsingular) leaves intersecting h and so that $h \cap e_i$ escapes compact sets in h and moves in the direction toward the perfect fit with l . Since l and h form a perfect fit, then for big enough i , the e_i and d_i intersect and form a polygonal path of length 2; see Figure 8.

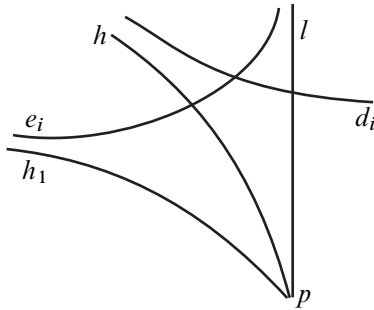

Figure 8. The process of creating standard sequences for rays of $\mathcal{O}^s, \mathcal{O}^u$. Here the sequence (d_i) of \mathcal{O}^u does not escape compact sets and limits to a leaf h of \mathcal{O}^u making a perfect fit with l . There is also the sequence (e_i) of leaves of \mathcal{O}^s whose intersection with h escapes in h and (e_i) limits to a leaf h_1 of \mathcal{O}^s making a perfect fit with h . The leaves l, h_1 are not separated from each other in the leaf space of \mathcal{O}^s .

We want to produce an escaping polygonal sequence in that side of l and we already achieved that with $d_i \cup e_i$ for the region between l and h . Therefore we want to analyze what happens beyond h , that is, the side of h opposite to l or not containing l . If the rays of $e_i - h$ in the side of h opposite to l escape in \mathcal{O} then the polygonal paths made up of a segment of d_i and a ray of e_i escape compact sets in \mathcal{O} . Otherwise the rays of $e_i - h$ on that side of h limit to a stable leaf h_1 making a perfect fit with h ; see Figure 8. Notice that h_1 and l are not separated from each other in the leaf space of \mathcal{O}^s , because the sequence (e_i) converges to both of these leaves. Now iterate this process. If this stops after finitely many steps then take a sequence of polygonal paths of fixed length. Otherwise there are infinitely many leaves $h_j, j \geq 2$, alternatively

in $\mathcal{O}^s, \mathcal{O}^u$, so that appropriate rays of h_j make a perfect fit with h_{j-1} and h_{j+1} . In this case use polygonal paths of increasing lengths, in order to cross over an increasing number of perfect fits emanating from l ; see Figure 9. Do the same for the other side

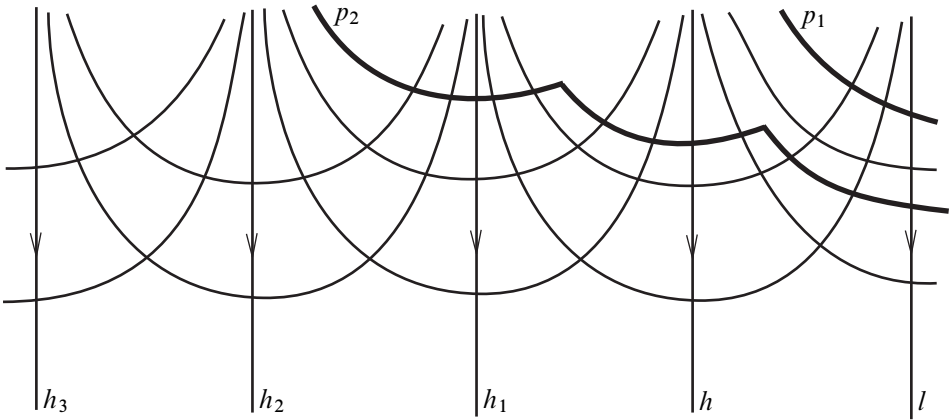

Figure 9. A picture of an infinite perfect fit or a perfect fit horoball. Here l, h_1, h_3 are rays of \mathcal{O}^s and h, h_2 are rays of \mathcal{O}^u . The arrows indicate the direction of the rays. l and h_1 are not separated from each other in the leaf space of \mathcal{O}^s and similarly for h_1, h_3 and also for h, h_2 (leaf space of \mathcal{O}^u for the last 2). The figure is intended to continue indefinitely in both horizontal directions. The bold paths p_1, p_2 are 2 steps in producing a standard sequence for the ray l . p_1 is a polygonal path of length 1 and p_2 is a polygonal path of length 3 (we are only describing what happens in one side of l).

of l . The ensuing sequence (a_i) is an admissible sequence associated to the ray l . It is called a standard sequence for the ray l of \mathcal{O}^s or \mathcal{O}^u .

Remark If there are no perfect fits then (d_i) as in Definition 3.8 is a standard sequence for the ray l .

There are several other important remarks here and they concern only the case with perfect fits. Along the way we will introduce the concepts of infinite perfect fits and perfect fit horoballs. First notice that standard sequences for a given ray l are not unique. By construction it is easy to see that the a_i are convex, the rays of each a_i are not equivalent to each other and the sequence (a_i) is nested. To check whether \tilde{a}_i is escaping: If the a_i have fixed length with i then it is easy to see this. Otherwise notice that the collection of rays equivalent to a given ray escapes compact sets in \mathcal{O} , in fact the whole leaves do. That is, if $h_1, h_2, h_3, h_4, \dots$ are the leaves produced by

the construction in the definition, then h_j, h_{j+2} are not separated from each other in the respective leaf space. Then the sequence (h_i) escapes compact sets in \mathcal{O} . So the sequence (a_i) again escapes compact sets. Hence (a_i) is admissible. In addition h_i separates h_k from h_j for any $k < i < j$.

Infinite perfect fits and perfect fit horoballs In the case that the process above does not stop we call the infinite collection of perfect fits an *infinite perfect fit*. Associated to this one can define a model for a *perfect fit horoball* in \mathcal{O} as follows: take the punctured square $[-1, 1] \times [-1, 1] - \{0, 0\}$ with its horizontal and vertical foliations and lift it to its universal cover U . A proper, foliation respecting (horizontal goes to stable, vertical goes to unstable) embedding of U into \mathcal{O} gives an intuitive “neighborhood” of an ideal point associated to an infinite perfect fit as above. Such points clearly seem to have a “parabolic” feel as one suspects there is a covering translation which preserves the perfect fit horoball and acts as a translation in the collection of the perfect fits. This is in analogy with Kleinian groups.

Two important questions arise: Is this possible for pseudo-Anosov flows? Also is there a nontrivial isotropy group of this infinite perfect fit structure and why does it not contradict that the action of $\pi_1(M)$ is cocompact? First of all this phenomenon does happen, in fact there are several examples, even for Anosov flows. The first one is the seminal example of Franks and Williams [30] of an intransitive Anosov flow in a closed 3-manifold. There is a simple picture of an infinite perfect fit in the figure on page 164 of [30]. A second, also famous example, is that of the Bonatti–Langevin [6] example of a transitive Anosov flow with a transverse torus and not conjugate to a suspension. The structure in the universal cover of this example is briefly described in [24].

Once existence of infinite perfect fits is established, one wants to understand its structure. Notice that infinite perfect fits have in particular infinitely many pairs of leaves nonseparated from each other. The author previously proved [24; 25] that up to covering translations there are only finitely leaves of \mathcal{O}^s or \mathcal{O}^u which are not separated from another leaf in the respective leaf space. Hence given the collection (h_j) produced above so that h_j forms a perfect fit with h_{j+1} , there are $j \neq k$ and g in $\pi_1(M)$ so that $g(h_j) = h_k$. This implies that the infinite sequence of perfect fits is in fact a bi-infinite sequence, that is, it extends indefinitely in the other direction as well. It also justifies the terminology parabolic used above. In addition if z in $\mathcal{O}^s, \mathcal{O}^u$ is nonseparated from another leaf, then the isotropy group of z is nontrivial [24; 25]. In particular this is true of every h_j . With a little more work this implies that associated to an infinite perfect fit there is a $\mathbf{Z}^2 \oplus \mathbf{Z}^2$ subgroup of $\pi_1(M)$ which leaves the whole structure invariant. Hence if M is atoroidal, there can be no infinite sequence of perfect fits.

Finally, given the association of parabolic behavior with noncompact manifolds, how does this interact with the fact that M is compact? In the case of a hyperbolic 3-manifold and a $\mathbf{Z} \oplus \mathbf{Z}$ cusp, then geodesics escaping to the cusp are asymptotic. In the case of pseudo-Anosov flows, suppose that leaves l, h of \mathcal{O}^s and \mathcal{O}^u make a perfect fit. We need to analyze the situation in \tilde{M} , not \mathcal{O} . Let then (say) L in $\tilde{\Lambda}^s$ which projects to l in \mathcal{O} and similarly H in $\tilde{\Lambda}^u$ projecting to h . Then L, H make a perfect fit. But they are not asymptotic as points escape in L or H . If they were, then in fact L and H would intersect because of the local product structure of Λ^s, Λ^u . In particular L, H would not form a perfect fit. At this point it is useful to stress once more that the orbit space \mathcal{O} is a topological and dynamical object, but it is *not* a metric object. Even though topologically it may seem that rays of $\mathcal{O}^s, \mathcal{O}^u$ making a perfect fit are getting close, this can only be checked in \tilde{M} , where in fact one sees that their lifts are not getting close.

Lemma 3.9 *Let l be a ray in \mathcal{O}^s or \mathcal{O}^u and let $C = (c_i)$ be a standard sequence associated to l . Let $A = (a_i)$ be an admissible sequence so that for any i , then $\tilde{a}_i \cup a_i$ contains a ray equivalent to l . Then $A \leq C$.*

Proof Suppose the lemma is not true and fix an i so that for any j , $\tilde{a}_j \not\subset \tilde{c}_i$. Notice first that by the definition of a standard sequence, then for any m (in particular for $m = i$) and for any ray s equivalent to l , then s has a subray s' contained in \tilde{c}_m . Since for any j , $\tilde{a}_j \cap a_j$ contains such a ray s then $\tilde{a}_j \cap \tilde{c}_i \neq \emptyset$. If in addition $\tilde{a}_j \not\subset \tilde{c}_i$, then as seen in the fundamental lemma, for j big enough, there is at least one ray of c_i which has a subray contained in \tilde{a}_j . By the fundamental lemma, after discarding finitely many terms in (a_j) there is a fixed ray r of (c_i) which for every j has a subray contained in \tilde{a}_j . Notice that r and l are not equivalent. We conclude that every \tilde{c}_j contains a subray of the fixed ray l and every \tilde{a}_j contains a subray of the fixed ray r . Since for any j, m , $\tilde{c}_j \cap \tilde{a}_m \neq \emptyset$ this is disallowed by the fundamental lemma. This finishes the proof of the lemma. \square

We now define ideal points of \mathcal{O} .

Definition 3.10 Suppose that Φ is not topologically conjugate to a suspension Anosov flow. A point in $\partial\mathcal{O}$ or an ideal point of \mathcal{O} is an equivalence class of admissible sequences of polygonal paths. Let $\mathcal{D} = \mathcal{O} \cup \partial\mathcal{O}$.

Given R , an admissible sequence of polygonal paths, let \bar{R} be its equivalence class under \cong . Notice that each ray l in $\mathcal{O}^s, \mathcal{O}^u$ has admissible sequences and these sequences are all equivalent. In this way l defines a single point in $\partial\mathcal{O}$ which is

denoted by ∂l . This is generalized in the following way: if l is a leaf of \mathcal{O}^s or \mathcal{O}^u , then we denote by ∂l the collection of ideal points of rays of l . If l is a ray of \mathcal{O}^s , \mathcal{O}^u associated to an infinite perfect fit then ∂l is called a parabolic ideal point in $\partial\mathcal{O}$. We will see later that in this case ∂l is the unique fixed point of the action of some g in $\pi_1(M)$ which acts in a “parabolic” way on $\partial\mathcal{O}$.

Definition 3.11 (Master sequences) Let R be an admissible sequence. An admissible sequence C defining \bar{R} is a master sequence for \bar{R} if for any $B \cong R$, then $B \leq C$.

Why master sequences? Ideal points are defined by admissible sequences of polygonal paths and not by sequences of points in \mathcal{O} . Given the admissible sequence (a_i) defining an ideal point p , one intuitively expects that a fixed \tilde{a}_i will at least limit on all points of $\partial\mathcal{O}$ near p (the topology in $\mathcal{O} \cup \partial\mathcal{O}$ will be defined formally later). However this is not the case. For example given l a ray in \mathcal{O}^s with no perfect fits associated to it, consider a sequence of regular leaves d_i in \mathcal{O}^u with $d_i \cap l$ escaping in l . Then (d_i) defines the ideal point ∂l . Now fix a side of l and consider the rays of $d_i - l$ in this side of l . For each i , this ray, together with an appropriate subray of l forms a convex polygonal path b_i and defines an admissible sequence (b_i) . Intuitively \tilde{b}_i is \tilde{d}_i cut in half by a ray of l . Clearly (d_i) and (b_i) are equivalent, so (b_i) also defines the same ideal point. But a fixed \tilde{b}_i only accumulates on one side of l . The master sequences are those (d_i) for which an individual \tilde{d}_i “limits on both sides” of the ideal point.

Remark Recall that a *cyclic order* on a set B is a partition of the set of pairwise distinct triples (p, q, r) into two sets, called the “positive and negative triples”, such that cyclic permutations in (p, q, r) preserve the sign, noncyclic permutations reverse the sign and if (p, q, r) and (r, s, p) are positive triples, then (q, r, s) is also a positive triple.

Definition 3.12 (Order of sets in \mathcal{O}) Let $\mathcal{C} = \{c_i\}, i \in I \subset \mathbf{Z}$ be a collection of properly embedded bi-infinite arcs in \mathcal{O} so that there are components \tilde{c}_i of $\mathcal{O} - c_i$ with $\{c_i \cup \tilde{c}_i\}$ pairwise disjoint. Suppose that \mathcal{C} is locally finite: any compact set in \mathcal{O} intersects only finitely many of the c_i . Fix $x \in \mathcal{O}$ not in any $c_i \cup d_i$ and choose paths γ_i from x to c_i which are pairwise disjoint except for x . This is all possible since $\mathcal{O} \cong \mathbf{R}^2$. Then the germs of the collection $\{\gamma_i\}$ at x put a cyclic order in the collection $\{\gamma_i\}$ and hence on \mathcal{C} . This order is independent of x or the paths γ_i . If all \tilde{c}_i miss a fixed properly embedded infinite arc γ starting at x , then there is a linear order in \mathcal{C} . The linear order depends on the path γ .

Lemma 3.13 Given an admissible sequence R , there is a master sequence for \bar{R} .

Proof Case 1 Suppose that for any $A = (a_i)$, $B = (b_i)$ in \bar{R} and for any i, j then $\tilde{a}_i \cap \tilde{b}_j \neq \emptyset$.

We claim that in this case any $A \cong R$ will serve as a master sequence. That is we do not have the situation described above were one slices through the admissible regions using a fixed ray of \mathcal{O}^s or \mathcal{O}^u . Choose $A \cong R$ and let $B \cong R$. We want to show that $B \leq A$. So by way of contradiction,

(*) assume that there is i so that for any j , $\tilde{b}_j \not\subset \tilde{a}_i$.

This also works for any $k \geq i$, but we will fix i from now on in Case 1. The contradiction will be obtained by first showing that (*) implies that A is associated to an ideal point of a ray of \mathcal{O}^s or \mathcal{O}^u and then producing two admissible sequences in \bar{R} which fail the hypothesis of Case 1.

In Case 1, $\tilde{b}_j \cap \tilde{a}_i$ is not empty for any j . Let u, v be the rays of a_i . Since \tilde{b}_j escapes compact sets in \mathcal{O} as $j \rightarrow \infty$, so does $\tilde{b}_j \cap \tilde{a}_i$. The arguments of Lemma 3.7, referring to Figure 7(a); show that $\tilde{a}_i \cup a_i$ cannot contain subrays of both rays in b_j and in fact for j big enough, then \tilde{b}_j contains at least one subray u or v and no singular point. This implies that a_i cuts \tilde{b}_j into at most 3 noncompact regions (all of which are convex): at most one region contained in \tilde{a}_i and at least one and at most 2 disjoint from \tilde{a}_i . The regions are convex because one can assume j is big enough so that the $b_j \cap a_i$ does not contain any singularity. Up to discarding finitely many terms we may assume that one region contains in its boundary a subray of (say) u . Call this region \tilde{c}_j with boundary c_j .

There are 2 possibilities: (i) For j big enough, the region \tilde{c}_j disappears, that is, there is no such region with a subray u in the boundary. In that case there is another region \tilde{d}_j of \tilde{b}_j cut along a_i disjoint from \tilde{a}_i and containing a subray of v in the boundary. If \tilde{d}_j also eventually disappears, then some \tilde{b}_k is contained in \tilde{a}_i , contrary to assumption in this argument. So at least one of (\tilde{c}_j) , (\tilde{d}_j) is always nonempty. This reduces to the following: (ii) (say) \tilde{c}_j is never empty for any j . Then \tilde{b}_j contains a subray of u for any j . Let $E = (e_k)$ be a standard sequence associated with the ray u . Eliminating finitely many initial terms of E if necessary we can assume that u cuts every \tilde{e}_k into two components \tilde{f}_k and \tilde{g}_k , which are convex, with boundaries f_k and g_k respectively and defining admissible sequences $F = (f_k)$ and $G = (g_k)$. Assume that $\tilde{f}_k \cap \tilde{a}_i = \emptyset$ for all k . Clearly $F \leq E, G \leq E$ and $f_k \cap \tilde{g}_k = \emptyset$.

Suppose that for some $m > i$, a_m does not have a ray equivalent to u . Fix this m . Notice that \tilde{b}_j contains a subray of a fixed ray of a_m and also a fixed subray of u (this is a ray of a_i with i fixed). This is now disallowed by the fundamental lemma.

The remaining possibility in this case is that a_m always has a ray equivalent to u for any m . By Lemma 3.9 it follows that $A \leq E$ and so $R \cong A \cong E \cong F \cong G$. Hence in \bar{R} there are $F = (f_k)$, $G = (g_k)$ with $\tilde{f}_k \cap \tilde{g}_k = \emptyset$ for some k . This contradicts the hypothesis in Case 1 and implies that A is a master sequence for \bar{R} .

Case 2 There are A, B in \bar{R} and i so that \tilde{a}_i, \tilde{b}_i are disjoint.

Fix this i . In particular \tilde{a}_k, \tilde{b}_k are disjoint for $k \geq i$. Let C be an admissible sequence with $A \leq C$, $B \leq C$. We claim that C is a master sequence for the class \bar{R} . Let $D \cong A$. Suppose that $D \not\leq C$. Hence there is m so that $\tilde{d}_j \not\leq \tilde{c}_m$ for any j . Fix this m . There are two options: (i) There is k with $\tilde{d}_k \cap \tilde{c}_k = \emptyset$. (ii) For any k , $\tilde{d}_k \cap \tilde{c}_k \neq \emptyset$, in which case $\tilde{d}_k \cap \tilde{c}_j \neq \emptyset$ for any k, j .

In Subcase (i) up to deleting a few initial terms we may assume that $\tilde{d}_1 \cap \tilde{c}_1 = \emptyset$. We have $A \cong B \cong D$ with $\tilde{a}_i, \tilde{b}_i, \tilde{d}_i$ disjoint. Choose $E = (e_j)$ with $C \leq E$, $D \leq E$. Assume for simplicity that i is big enough so that $\tilde{a}_i, \tilde{b}_i, \tilde{d}_i$ are contained in \tilde{e}_1 . This puts a linear order in a_i, b_i, d_i and we can assume without loss of generality that b_i is between a_i and d_i . Since b_i is between a_i and d_i then: for any j , \tilde{e}_j contains subrays of the rays of b_i (with i fixed!), which are not equivalent. The fundamental Lemma 3.6 implies this is impossible.

We now consider option (ii). Since $\tilde{a}_i \cup a_i$ and $\tilde{b}_i \cup b_i$ are disjoint and $A \leq C$, $B \leq C$, then there is a ray u of a_i and a ray v of b_i so that for any j , \tilde{c}_j contains subrays of u and v . A priori u, v can be equivalent. Since \tilde{d}_j is not contained in \tilde{c}_m but has to intersect \tilde{c}_m , we may assume up to eliminating a few initial terms that \tilde{d}_j always contains a subray of a fixed ray y of c_m . The rays y, u are not equivalent. Since $\tilde{d}_j \cap \tilde{c}_k \neq \emptyset$ for any k, j , this contradicts the fundamental lemma. So this cannot happen either.

We conclude that C is a master sequence for \bar{R} , finishing the proof of Lemma 3.13. \square

By definition for any 2 master sequences A, B in the class \bar{R} , it follows that both $A \leq B$ and $B \leq A$ hold.

Lemma 3.14 *Let p, q in $\partial\mathcal{O}$. Then p, q are distinct if and only if there are master sequences $A = (a_i)$, $B = (b_i)$ associated to p, q respectively with $(a_i \cup \tilde{a}_i) \cap (b_j \cup \tilde{b}_j) = \emptyset$ for some i, j .*

Proof We first show that p, q are distinct if and only if there are master sequences $A = (a_i)$, $B = (b_i)$, so that for some i, j , $\tilde{a}_i \cap \tilde{b}_j = \emptyset$. In the proof we show that the negations are equivalent. First suppose that $p = q$. Let A, B be any master sequences associated to $p = q$. Then since A, B are master sequences associated to the same

equivalence class then $A \leq B$ and $B \leq A$. Therefore we can never have $\tilde{a}_i \cap \tilde{b}_j = \emptyset$. This is the easy implication.

To prove the converse, suppose that for any master sequences $A = (a_i)$ and $B = (b_i)$ associated to p, q respectively and any i, j then $\tilde{a}_i \cap \tilde{b}_j \neq \emptyset$. Let A, B be such a pair. Suppose first that for all i , $\tilde{a}_i \cap \tilde{b}_i$ has 2 noncompact components. Then an argument similar to one in the proof of Lemma 3.13 shows that there are nonequivalent rays u, v with subrays contained in each $\tilde{a}_i \cap \tilde{b}_i$. This is disallowed by the fundamental lemma. Similarly if $\tilde{a}_i \cap \tilde{b}_i$ has a component with 4 boundary rays for infinitely many i . On the other hand, $\tilde{b}_i \cap \tilde{a}_j$ can never be contained in a compact set or else for some $i' > i$ then $\tilde{a}_j \cap \tilde{b}_{i'} = \emptyset$. One concludes that $\tilde{a}_i \cap \tilde{b}_i$ eventually has a single noncompact component. Let \tilde{c}_i be this component of $\tilde{a}_i \cap \tilde{b}_i$ and let $c_i = \partial\tilde{c}_i$. Let $C = (c_i)$. Clearly c_i is convex and (c_i) is nested. But a priori, C may not be admissible, that is, the boundary rays may be equivalent. Notice that the rays in c_i are subrays of rays of a_i or b_i .

The first case is that the rays of c_i are not equivalent for any i . Then c_i is a convex polygonal path, nonempty and C is an admissible sequence. Also $C \leq A$, $C \leq B$, which implies that $A \cong C \cong B$ and hence $p = q$.

The second case is that there is i so that the rays u, v of c_i are equivalent. Notice this can only happen if there are perfect fits. There is a collection $\mathcal{Y} = \{u_0 = u, u_1, \dots, u_n = v\}$ of rays of $\mathcal{O}^u, \mathcal{O}^s$ so that u_k, u_{k+1} make a perfect fit for every k . Since the sequence (\tilde{c}_j) is nested with j , the rays of c_j for $j > j_0$ have to be in the collection \mathcal{Y} . Up to subsequence we can assume they are all subrays of fixed rays r, l . Notice that $r \neq l$, or else $\tilde{b}_j \cap \tilde{a}_j = \emptyset$ for some $j > i$. Since r, l are equivalent they cannot both be rays of a_j (or both of b_j either). Hence up to renaming objects, a_j has a subray in r and b_j has a subray in l , for all $j > i$; see Figure 10.

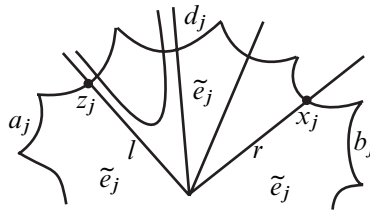

Figure 10. Interpolating chains that intersect to produce a new convex chain

Let $z_j = a_j \cap l$, $x_j = r \cap b_j$. As in the proof of the fundamental lemma notice that \tilde{b}_j contains a subray of r and \tilde{a}_j contains a subray of l . Then z_j escapes in l and x_j escapes in r . Let a'_j be the component of $a_j - z_j$ not containing a subray of r

and b'_j the component of $b_j - x_j$ not containing a subray of l . The above implies that we can connect z_j, x_j by a finite convex polygonal path d_j which extends $a'_j \cup b'_j$ to a convex polygonal path e_j . see [Figure 10](#). This is because l, r are connected by finitely many perfect fits. If z_j, x_j are very deep in the rays l, r then we can always connect z_j and x_j by a convex polygonal path. Notice that a_j has a subray of r so it goes to r , but a_j may reach r in a point different than x_j . If we just connect this to x_j and then follow along b_j this will produce a nonconvex switch in r . That is why we use the interpolating polygonal path d_j . Then the polygonal paths e_j are convex and one can construct the interpolating polygonal path d_j so that e_j escapes compact sets as $j \rightarrow \infty$. Then $E = (e_j)$ defines an admissible sequence of chains. Clearly $A \leq E$ and $B \leq E$ so that $A \cong B$ and again $p = q$.

This finishes the equivalence with the intersection condition on open sets. Finally suppose that $\tilde{a}_i \cap \tilde{b}_i = \emptyset$ for all sufficiently big i , but $(a_i \cup \tilde{a}_i) \cap (b_i \cup \tilde{b}_i) \neq \emptyset$ for any i . This can only happen if there is a ray l of \mathcal{O}^s or \mathcal{O}^u so that both a_i and b_i have a subray of l . Let $C = (c_i)$ be a standard sequence for l . By [Lemma 3.9](#), $A \leq C$ and $B \leq C$, so $A \cong B$ and $p = q$. This proves the lemma. \square

We now define the topology in $\mathcal{D} = \mathcal{O} \cup \partial\mathcal{O}$.

Definition 3.15 (Topology in $\mathcal{D} = \mathcal{O} \cup \partial\mathcal{O}$) Let \mathcal{T} be the set of subsets U of $\mathcal{D} = \mathcal{O} \cup \partial\mathcal{O}$ satisfying the following two conditions:

- (a) $U \cap \mathcal{O}$ is open in \mathcal{O} .
- (b) If p is in $U \cap \partial\mathcal{O}$ and $A = (a_i)$ is any master sequence associated to p , then there is i_0 satisfying two conditions: (1) $\tilde{a}_{i_0} \subset U \cap \mathcal{O}$ and (2) For any z in $\partial\mathcal{O}$, if it admits a master sequence $B = (b_i)$ so that for some j_0 , one has $\tilde{b}_{j_0} \subset \tilde{a}_{i_0}$ then z is in U .

First notice that if the second requirement works for a master sequence $A = (a_i)$ with index i_0 , then for any other master sequence $C = (c_k)$ defining p , we can choose k_0 with $\tilde{c}_{k_0} \subset \tilde{a}_{i_0}$. Then $\tilde{c}_{k_0} \subset U$. A point q of $\partial\mathcal{O}$ which has a master sequence $B = (b_j)$ and j_0 so that

$$\tilde{b}_{j_0} \subset \tilde{c}_{k_0}; \quad \text{then } \tilde{b}_{j_0} \subset \tilde{a}_{i_0}$$

so q is in U . Therefore (b) works for C instead of A with k_0 instead of i_0 . So we only need to check the requirements for a single master sequence.

Lemma 3.16 \mathcal{T} is a topology in $\mathcal{D} = \mathcal{O} \cup \partial\mathcal{O}$.

Proof Clearly \mathcal{D}, \emptyset are in \mathcal{T} . Unions: If $\{V_\alpha \mid \alpha \in \mathcal{A}\}$ is a family of sets in \mathcal{T} , then let V be their union. If x is in V and x is in \mathcal{O} , there is open set O in \mathcal{O} with $x \in O \subset V_\alpha \subset V$ for some index α , hence satisfying condition (a). Let now p in $V \cap \partial\mathcal{O}$. There is $\beta \in \mathcal{A}$ with $p \in V_\beta$. Let $A = (a_i)$ be a master sequence associated to p . There is i_0 with

$$\tilde{a}_{i_0} \subset V_\beta \cap \mathcal{O} \subset V \cap \mathcal{O} \subset \mathcal{O}.$$

In addition if $q \in \partial\mathcal{O}$ and q has a master sequence $B = \{b_j\}$ and j_0 with $\tilde{b}_{j_0} \subset \tilde{a}_{i_0}$ then q is in $V_\beta \subset V$. Hence this i_0 works for V as well. This proves that V is in \mathcal{T} .

Intersections: Let V_1, V_2 be in \mathcal{T} and $V = V_1 \cap V_2$. Clearly $V_1 \cap V_2 \cap \mathcal{O}$ is open in \mathcal{O} . Let $u \in V_1 \cap V_2 \cap \partial\mathcal{O}$. Given a master sequence $A = (a_i)$ associated to u there is i_1 with $\tilde{a}_{i_1} \subset V_1$ and if q has master sequence $B = (b_j)$ with $\tilde{b}_{j_0} \subset \tilde{a}_{i_1}$ then q is in V_1 . Similarly considering $u \in V_2$, there is index i_2 satisfying the conditions for V_2 . Let $i_0 = \max(i_1, i_2)$. Then \tilde{a}_{i_0} is contained in V_1 and V_2 (since \tilde{a}_i are nested). If now q in $\partial\mathcal{O}$ has a master sequence $B = (b_j)$ with $\tilde{b}_{j_0} \subset \tilde{a}_{i_0}$ for some j_0 then q is in V_1 and is in V_2 by choice of i_1, i_2 . Therefore q is in V . Hence V is in \mathcal{T} . This shows \mathcal{T} is a topology in $\mathcal{O} \cup \partial\mathcal{O}$. □

Action of $\pi_1(M)$ on $\mathcal{D} = \mathcal{O} \cup \partial\mathcal{O}$ One key remark is that the action of $\pi_1(M)$ on \mathcal{O} preserves the foliations $\mathcal{O}^s, \mathcal{O}^u$ and sends convex polygonal paths to convex polygonal paths. It follows that $\pi_1(M)$ acts by homeomorphisms on \mathcal{D} .

Lemma 3.17 *Suppose $\pi_1(M)$ preserves orientation in \mathcal{O} . Then $\partial\mathcal{O}$ has a natural cyclic order.*

Proof Let p, q, r in $\partial\mathcal{O}$ pairwise distinct points. By Lemma 3.14, there are master sequences $A = (a_i), B = (b_i), C = (c_i)$ associated to p, q, r respectively with $a_1 \cup \tilde{a}_1, b_1 \cup \tilde{b}_1, c_1 \cup \tilde{c}_1$ pairwise disjoint. By Definition 3.12 there is a cyclic order on a_1, b_1, c_1 . This defines a cyclic order on p, q, r . This is independent of the choice of master sequences (since they are all equivalent). This order is also invariant under the action of $\pi_1(M)$ on \mathcal{O} , since $\pi_1(M)$ preserves orientation in \mathcal{O} . This defines a natural cyclic order in $\partial\mathcal{O}$. □

In general let \mathcal{E} be the index 2 subgroup of $\pi_1(M)$ preserving orientation of \mathcal{O} . Then \mathcal{E} preserves a cyclic order in $\partial\mathcal{O}$ and the elements in $\pi_1(M) - \mathcal{E}$ reverse this cyclic order.

In any case pick one orientation in \mathcal{O} that defines a cyclic order in $\partial\mathcal{O}$ (invariant only under \mathcal{E}).

Definition 3.18 (The set U_c) For any convex polygonal path c there is an associated open set U_c of \mathcal{D} : let \tilde{c} be the corresponding convex set of \mathcal{O} (if c has length 1 there are two possibilities). Let

$$U_c = \tilde{c} \cup \{x \in \partial\mathcal{O} \mid \text{there is a master sequence } A = (a_i) \text{ with } \tilde{a}_1 \subset \tilde{c}\}.$$

It is easy to verify that U_c is always an open set in \mathcal{D} . In particular it is an open neighborhood of any point in $U_c \cap \partial\mathcal{O}$. The rays of c are equivalent if and only if U_c is contained in \mathcal{O} . The notation U_c will be used from now on.

Given a cyclic order in \mathcal{O} and p, q distinct in $\partial\mathcal{O}$, let

$$(p, q) := \{x \in \partial\mathcal{O} \mid (p, x, q) \text{ is positive in the cyclic order of } \mathcal{O}\}.$$

This is the interval from p to q in the cyclic order. Notice that if one changes the cyclic ordering then (p, q) of the new cyclic order is (q, p) of the old cyclic order. So the collection of intervals is independent of the order. Let \mathcal{Z} be the topology in $\partial\mathcal{O}$ generated by the intervals. Given t in (p, q) there is a master sequence $A = (a_i)$ for t with $U_{a_1} \cap \partial\mathcal{O} \subset (p, q)$. Hence (p, q) is open in the topology of $\partial\mathcal{O}$. Conversely if T is open in $\partial\mathcal{O}$ and $t \in T$, there is a master sequence $A = (a_i)$ satisfying property (b) of definition of the topology in $\partial\mathcal{O}$, so that $U_{a_1} \cap \partial\mathcal{O} \subset T$. The endpoints of the rays of a_1 are p, q and then $t \in (p, q) \subset T$. So the interval topology is exactly the induced topology in $\partial\mathcal{O}$.

Lemma 3.19 \mathcal{D} is Hausdorff.

Proof Any two points in \mathcal{O} are separated from each other. If p, q are distinct in $\partial\mathcal{O}$ choose master sequences $A = (a_i)$ and $B = (b_i)$, where $\tilde{a}_1 \cap \tilde{b}_1 = \emptyset$. Let U_{a_1} be the open set of \mathcal{D} associated to a_1 and U_{b_1} associated to b_1 . By definition U_{a_1} is an open neighborhood of p and likewise U_{b_1} for q . They are disjoint open sets of \mathcal{D} .

Finally if p is in \mathcal{O} and q is in $\partial\mathcal{O}$, choose U a neighborhood of q coming from a master sequence as above so that $U \cap \mathcal{O}$ does not have p in its closure – always possible because master sequences are escaping sets. Hence there are disjoint neighborhoods of p, q . \square

Our goal is to show that $\partial\mathcal{O}$ is homeomorphic to \mathbf{S}^1 and that \mathcal{D} is homeomorphic to a closed disk. We need a few simple results:

Lemma 3.20 For any ray l of \mathcal{O}^s or \mathcal{O}^u , there is an associated point in $\partial\mathcal{O}$. Two rays generate the same point of \mathcal{O} if and only if the rays are equivalent (as rays!).

Proof Given a ray l any standard sequence (c_i) associated to it defines a point in $\partial\mathcal{O}$. Let r, l be rays of $\mathcal{O}^s, \mathcal{O}^u$. If they define the same point of $\partial\mathcal{O}$, then there is a master sequence $C = (c_i)$ for this point. Since both standard sequences associated to r, l are $\leq C$, it follows that every \tilde{c}_i contains subrays of both l, r . By the fundamental lemma (where we use $E = F = C$ in that lemma), this occurs if and only if the rays r, l are equivalent. \square

Lemma 3.21 *Suppose that $A = (a_i)$ is an admissible sequence of polygonal paths and that every a_i contains a subray of a fixed ray l of \mathcal{O}^s or \mathcal{O}^u . Then A is associated to the ideal point ∂l of l and A is not a master sequence for the point ∂l of $\partial\mathcal{O}$.*

Proof The point ∂l was defined just before Definition 3.11. The first statement was proved in Lemma 3.9. For the second statement, notice that each \tilde{a}_i is contained in a fixed side of $\mathcal{O} - l$. Choose a standard sequence B associated to l and cut it along l . Let C be the admissible sequence produced so that $\tilde{c}_1 \cap \tilde{a}_1 = \emptyset$. This shows that A is not a master sequence for ∂l . \square

Lemma 3.22 *Let $A = (a_i)$ be an admissible sequence defining a point p in $\partial\mathcal{O}$. Then one of the following mutually exclusive possibilities occurs:*

- (i) *There are infinitely many i in \mathbf{N} and for each such i there is a ray l_i of a_i which is equivalent to a fixed ray l of \mathcal{O}^s or \mathcal{O}^u . Then p is the ideal point of any of the l_i and A is not a master sequence for p . In fact in this case the hypothesis is true for any i sufficiently big.*
- (ii) *There are only finitely many rays of paths in the collection $\{a_i\}$ which are equivalent to any given ray of \mathcal{O}^s or \mathcal{O}^u . In this case A is a master sequence for p .*

Proof Most of part (i) was proved in Lemma 3.9. The \tilde{a}_i are nested and hence the rays of a_i are split into two sequences $(r_i), (l_i)$ each of which is also “nested”. It is easy to check that only elements of one of the sequences can be equivalent to l . But if (say) r_i and r_j (with $j > i$) are both equivalent to l , then r_k is equivalent to l for any $i < k < j$. Hence the r_i are equivalent to p for any sufficiently big i . It does not follow however that for any big i, j , r_i and r_j share a subray. This is because there may be an infinite perfect fit, so the rays r_i can change with i escaping in the horoball model of an infinite perfect fit. Finally a standard sequence for the ray l and cutting shows that A is not a master sequence for ∂l . This proves (i).

To prove part (ii), let $A = (a_i)$ be an admissible sequence so that there are only finitely many rays of (a_i) which are equivalent to any given ray of \mathcal{O}^s or \mathcal{O}^u . Suppose by

way of contradiction that A is not a master sequence for p , so there is $B \cong A$ and $B \not\leq A$. Fix some n so that for no j , $\tilde{b}_j \subset \tilde{a}_n$. Hence this is true for any $n' > n$.

The first possibility is there are i, j , with $\tilde{b}_j \cap \tilde{a}_i = \emptyset$. let $E = (e_k)$ be an admissible sequence with $A \leq E, B \leq E$. Choose $k > i, j$, hence $\tilde{b}_k \cap \tilde{a}_k = \emptyset$ and so that a_k does not have any rays equivalent to any rays of a_i . Then any $\tilde{e}_m, m \geq k$ contains a fixed subray of b_k and a fixed subray of a_k and they are not equivalent by choice of k . This is disallowed by the fundamental lemma.

The second possibility is that $\tilde{b}_j \cap \tilde{a}_i \neq \emptyset$ for any i, j . Fix $k > n$ so that a_k does not have any ray equivalent to a ray of a_n . If the 2 rays of b_j have subrays contained in $\tilde{a}_n \cup a_n$ then $\tilde{b}_j - (\tilde{a}_j \cup a_j)$ is contained in a compact set of \mathcal{O} and as seen before this implies that for some $t > j$, then $\tilde{b}_t \subset \tilde{a}_n$, contrary to choice of n in part (ii). We conclude that for any sufficiently big m , $\tilde{b}_m \cup b_m$ is not contained in $\tilde{a}_n \cup a_n$ but has to intersect \tilde{a}_k . This implies that for big m , \tilde{b}_m has to contain a subray of a ray of a_n and a subray of a ray of a_k . Again this is disallowed by the fundamental lemma. This finishes the proof of the lemma. □

Lemma 3.23 *The space \mathcal{D} is first countable.*

Proof Let p be a point in \mathcal{D} . The result is clear if p is in \mathcal{O} so suppose that p is in $\partial\mathcal{O}$. Let $A = \{a_i\}$ be a master sequence associated to p . We claim that $\{U_{a_i}, i \in \mathbf{N}\}$ is a neighborhood basis at p . Let U be an open set containing p . By [Definition 3.15](#) there is i_0 with $\tilde{a}_{i_0} \subset U$ and if z in $\partial\mathcal{O}$ admits a master sequence $B = (b_i)$ so that for some j_0 then $\tilde{b}_{j_0} \subset \tilde{a}_{i_0}$, then z is in U . By the definition of $U_{a_{i_0}}$, it follows that $U_{a_{i_0}} \subset U$. Hence the collection $\{U_{a_i}, i \in \mathbf{N}\}$ forms a neighborhood basis at p . □

More importantly we have the following:

Lemma 3.24 *The space $\mathcal{D} = \mathcal{O} \cup \partial\mathcal{O}$ is second countable.*

Proof We first construct a candidate for a countable basis. Since \mathcal{O} is homeomorphic to \mathbf{R}^2 it has a countable basis \mathcal{B}_1 . Let $\mathcal{Z} = \{l \mid l \text{ is a periodic leaf of } \mathcal{O}^s \cup \mathcal{O}^u\}$. Let $\mathcal{B}_2 = \{U_{b_i} \mid b_i \in B = (b_i), B \text{ admissible, } b_i \text{ has all sides contained in leaves in } \mathcal{Z}\}$.

There are countably many leaves in \mathcal{Z} and so countably many intersections of these leaves. Since any polygonal path is a union of a finite number of sides, it now follows that \mathcal{B}_2 is a countable collection of open sets in \mathcal{D} . We want to show that $\mathcal{B} = \mathcal{B}_1 \cup \mathcal{B}_2$ is a basis for the topology in \mathcal{D} .

Let p in \mathcal{D} and V open set in \mathcal{D} containing p . If p is in \mathcal{O} there is U in \mathcal{B}_1 with $p \in U \subset V$. Suppose then that p is in $\partial\mathcal{O}$. Choose $A = (a_i)$ a master sequence for p . According to [Definition 3.15](#) there is j with $U_{a_j} \subset V$.

We now modify the sides of the a_j to a convex polygonal path with sides in \mathcal{Z} . The sides of a_j in periodic leaves are left unchanged. A side in a nonperiodic leaf is pushed slightly in the direction of \tilde{a}_j to a periodic leaf. Notice that the union of periodic leaves of \mathcal{O}^s (or \mathcal{O}^u) is dense in \mathcal{O} . The proof is done in 2 steps. First we do this for the finite sides. The obstruction to pushing in a side of a_j , still intersecting the same adjacent sides is that there is a singularity in this side. But then this segment is already in a periodic leaf and we leave it unchanged. Do this for all finite sides of a_j to produce a new polygonal path b_i . Do this for all i . Given i , then since a_j escapes in \mathcal{O} with increasing j , then the finite segments of a_j are eventually contained in \tilde{b}_i . Hence the finite segments of b_j are contained in \tilde{b}_i . One can then take a subsequence of the (b_i) so that $B = (b_i)$ is nested. The b_i are convex and also (b_i) is eventually nested with the (a_i) . This implies that $B = (b_i)$ is also a master sequence for p .

The second step is to modify the rays of $B = (b_i)$ to be in periodic leaves. Given i , consider one ray l of b_i and l_t , $t \geq 0$ leaves of the same foliation as l , with l_t converging to l as $t \rightarrow 0$. In addition the l_t intersect the side of b_i adjacent to l . Note that this intersection of l and the adjacent side is not a singular point, otherwise l is periodic and we do not need to change it. If the l_t converges to another leaf (in \tilde{b}_i or not) besides l , then l is in a non-Hausdorff leaf and [Theorem 2.6](#) implies that l is in a periodic leaf and again we leave l as is. So we may assume that as $t \rightarrow 0$ then l_t converges only to the leaf of \mathcal{O}^s or \mathcal{O}^u containing l . There is $j_i > i$ so that l does not have a subray which is a side of b_{j_i} , otherwise $B = (b_j)$ would not be a master sequence, by [Lemma 3.22](#). Then there is t sufficiently small so that l_t separates l from b_{j_i} . This is true because l_t does not converge to any other leaf besides l . Choose also one t for which l_t is a periodic leaf and replace the ray l of b_i by this ray of l_t . After doing this to both rays of b_i this produces a convex polygonal path (c_i) . For each i then $\tilde{b}_{j_i} \subset \tilde{c}_i$, so $\tilde{c}_{j_i} \subset \tilde{c}_i$. So after taking a subsequence $C = (c_n)$ is nested. By the above, $C \cong B$ and C is a master sequence for p .

Hence we can find n with $U_{c_n} \subset V$. But all the sides of c_n are periodic. This shows that \mathcal{B} is a basis for the topology of \mathcal{D} and finishes the proof of the lemma. \square

Next we show that \mathcal{D} is a regular space, which will imply that \mathcal{D} is metrizable.

Lemma 3.25 *The space \mathcal{D} is a regular space.*

Proof Let p be a point in \mathcal{D} and V be a closed set not containing p . Suppose first that p is in \mathcal{O} . Here V^c is an open set with p in V^c , so there are open disks D_1, D_2 in \mathcal{O} , so that $p \in D_1 \subset \bar{D}_1 \subset D_2 \subset V^c$, producing disjoint neighborhoods D_1 of p and $(D_2)^c$ of V .

Suppose now that p is in $\partial\mathcal{O}$. Since p is not in the closed set V , there is an open set O of \mathcal{D} containing p and disjoint from V . Let $A = (a_i)$ be a master sequence associated to p . Then there is i_0 so that $U_{a_{i_0}}$ defined above is contained in O . We claim that the closure of \tilde{a}_{i_0} in \mathcal{D} is U_{i_0} union a_{i_0} plus the two ideal points of the rays in a_{i_0} . Clearly the closure of \tilde{a}_{i_0} in \mathcal{D} intersected with \mathcal{O} is obtained by just adjoining a_{i_0} . An ideal points of a ray l of a_i is clearly in the closure as any neighborhood of it contains a subray of l . Any other point p in $\partial\mathcal{O}$, if it is in $U_{a_{i_0}}$, then it is in the closure of \tilde{a}_{i_0} . If p is not in U_{i_0} and is not an ideal point of a_{i_0} then find a master sequence for p disjoint from master sequences of both ideal points of a_{i_0} and hence disjoint from U_{i_0} . Hence p is not in the closure of \tilde{a}_{i_0} . This proves the claim.

Choose j big enough so that the rays of a_j are not equivalent to any ray of a_{i_0} , again possible by [Lemma 3.22](#). By the above it follows that the closure of \tilde{a}_j is contained in $U_{a_{i_0}}$, hence

$$p \in U_{a_j} \subset \text{closure}(\tilde{a}_j) \subset U_{a_{i_0}} \subset O \subset V^c.$$

This proves that \mathcal{D} is regular. □

Corollary 3.26 *The space \mathcal{D} is metrizable.*

Proof Since \mathcal{D} is second countable and regular, the Urysohn metrization theorem (see [\[51, page 215\]](#)) implies that \mathcal{D} is metrizable. □

Therefore in order to prove that \mathcal{D} is compact it suffices to show that any sequence in \mathcal{D} has a convergent subsequence. But it is quite tricky to get a handle on an arbitrary sequence of points in \mathcal{O} or in $\partial\mathcal{O}$ and the proof that \mathcal{D} is compact is hard. This is the key property of \mathcal{D} . We first analyze one case which seems very special, but which in fact implies the general case without much additional work. Its proof is very involved because there are many cases to consider. First a preliminary result involving nonseparated leaves. By [Theorem 2.6](#) this does not occur in the case without perfect fits.

Lemma 3.27 *Let $\{E_i\}_{i \in \mathbb{Z}}$ be leaves of (say) \mathcal{O}^s which are all nonseparated from each other and ordered as in [Theorem 2.6](#). Associated to this collection there are two ideal points of \mathcal{O} , one for (E_i) with i converging to infinity and another one for (E_i) with i converging to minus infinity. A master sequence for any one of them is obtained with polygonal paths with length 2.*

Proof As explained in the end of Section 2, the collection $\{E_i\}$ is part of the boundary of a scalloped region \mathcal{S} . We will follow the notation from that section. The region \mathcal{S} is the union of infinitely many lozenges A_i and parts of their boundaries so that a half leaf of E_i is contained in the boundary of A_{2i} and another half leaf of E_i is contained in the boundary of A_{2i-1} . The lozenges A_i and A_{i+1} are adjacent for any $i \in \mathbf{Z}$ and they all intersect a single stable leaf C . This is depicted in Figure 3. Let γ_i be the periodic orbits in E_i . The collection of lozenges $\{A_i\}$ also creates another bi-infinite collection $\{G_i\}, i \in \mathbf{Z}$ of leaves of \mathcal{O}^s , all of which are nonseparated from each other and G_i has a half leaf in the boundary of A_{2i} and another half leaf in the boundary of A_{2i+1} . Let δ_i be the periodic orbit in G_i . The boundary of \mathcal{S} also has two bi-infinite collections of nonseparated leaves from \mathcal{O}^u : $\{S_j\}_{j \in \mathbf{Z}}$ and $\{T_j\}_{j \in \mathbf{Z}}$. These are chosen so that $\widetilde{W}^u(\gamma_i)$ converges to $\{S_j\}$ when $i \rightarrow \infty$ and $\widetilde{W}^u(\gamma_i)$ converges to $\{T_j\}$ when $i \rightarrow -\infty$. In addition S_j has a periodic orbit τ_j and we choose the indexing so that $\widetilde{W}^s(\tau_j)$ converges to $\{E_i\}$ when $i \rightarrow \infty$ and $\widetilde{W}^s(\tau_j)$ converges to $\{G_i\}$ when $i \rightarrow -\infty$. The collections $\{G_i\}, \{S_j\}$ are ordered with increasing i, j ; see also Theorem 2.6.

Now we define the ideal point associated to $\{E_i\}_{i \in \mathbf{Z}}$ when i converges to ∞ . For each positive i choose rays a_i in \mathcal{O}^u , b_i in \mathcal{O}^s which intersect only in their starting point u_i which is a point in \mathcal{S} and a_i intersects E_i and b_i intersects S_i ; see Figure 11(a). Let $d_i = a_i \cup b_i$, let \tilde{d}_i be the component of $\mathcal{O} - d_i$ which contains E_k for $k > i$

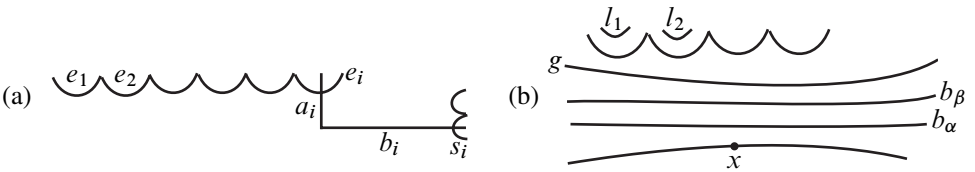

Figure 11. (a) Infinitely many nonseparated leaves converge to a single ideal point. (b) A more interesting situation

and S_k for $k > i$. The d_i are polygonal paths of length 2. It follows that d_i is convex for \tilde{d}_i . This uses the particular ordering in $\{E_i\}, \{S_j\}$ described above and it also follows that (d_i) is a nested sequence of polygonal paths.

In the explicit model (V) for a scalloped region given in the end of Section 2 we can choose

$$u_i = \left(1 - \frac{1}{2i-1}, 1 - \frac{1}{2i-1}\right), \quad a_i \cap \bar{\mathcal{S}} = \left\{1 - \frac{1}{2i-1}\right\} \times \left[1 - \frac{1}{2i-1}, 1\right],$$

$$b_i \cap \bar{\mathcal{S}} = \left[1 - \frac{1}{2i-1}, 1\right] \times \left\{1 - \frac{1}{2i-1}\right\}.$$

Notice that the ray a_i of \mathcal{O}^u is clearly not contained in \bar{S} , only the part contained in \bar{S} has a description in the explicit model. Similarly the ray b_i of \mathcal{O}^s is not contained in \bar{S} . It remains to check that the sequence (d_i) escapes compact sets in \mathcal{O} as $i \rightarrow \infty$. In the explicit model the a_i are subsets of the leaves $\widetilde{W}^u(\gamma_i)$. Any point in the limit of the sequence $(\widetilde{W}^u(\gamma_i))$ is nonseparated from the $\{S_j\}_{j \in \mathbb{Z}}$ and hence has to be in one of the S_j . It follows that the part of a_i outside \bar{S} escapes compact sets in \mathcal{O} . By construction the sequence made up of the parts of a_i in \bar{S} also does not limit in \mathcal{O} , hence (a_i) escapes compact sets in \mathcal{O} . The same is true for (b_i) so (d_i) escapes compact sets in \mathcal{O} and so $D = (d_i)$ is admissible and defines an ideal point p of \mathcal{O} . This p is associated to the positive infinite direction of the $\{E_i\}_{i \in \mathbb{Z}}$. By Lemma 3.22, D is a master sequence. Similarly associated to the negative direction of the $\{E_i\}$ there is another ideal point q of \mathcal{O} . \square

An ideal point p associated to infinitely many nonseparated leaves or equivalently to a scalloped region is called a *corner* of the scalloped region.

The technical lemma in the special case is the following:

Lemma 3.28 *Let $(l_i), i \in \mathbb{N}$ be a sequence of line leaves of \mathcal{O}^s (or \mathcal{O}^u) and let z_i in l_i . Suppose that for each i the set $\mathcal{O} - l_i$ has a component C_i so that each $C_i \cup l_i$ contains $\mathcal{O}^s(z_i)$ and also that the collection $\{C_i \cup l_i\}$ is pairwise disjoint. Suppose that the ordering of l_i (see Definition 3.12) is chosen so that the l_i are linearly ordered with i . Then in \mathcal{D} , the sequence $(C_i \cup l_i)$ converges to a point p in $\partial\mathcal{O}$.*

Proof The proof of this lemma is very involved because there are many possibilities and many places where the leaves l_i can slip through.

Suppose that l_i is always in \mathcal{O}^s as other cases are similar. If the l_i does not escape compact sets in \mathcal{O} when $i \rightarrow \infty$ then there are i_k and z_{i_k} in l_{i_k} with z_{i_k} converging to a point z . But then the C_{i_k} cannot all be disjoint, contradiction. Hence the (l_i) escapes in \mathcal{O} .

First notice that because the collection $\{l_i\}$ is linearly ordered with i , then if a subsequence $(l_{i_k} \cup C_{i_k})$ converges to p in \mathcal{D} , then the full sequence $(l_i \cup C_i)$ also converges to p in \mathcal{D} . Choose z_i in l_i .

Case 1 There is an infinite subsequence of the (l_j) , which we may assume is the original sequence so that l_j are all nonseparated from l_1 (in particular there are perfect fits).

Then the $\{l_j, j \in \mathbb{N}\}$ forms a subcollection of a collection $\{z_i\}_{i \in \mathbb{Z}}$ of nonseparated leaves of \mathcal{O}^s as in Lemma 3.27. Hence we can find a_j, b_j as in the previous lemma and for any i , l_i intersects a_{j_i} where j_i goes to infinity with i . As in the lemma let $d_j = a_j \cup b_j$

and $D = (d_j)$. Then D is a master sequence defining a point p in $\partial\mathcal{O}$. In addition given any j then for i big enough l_i is contained in \tilde{d}_j . Hence $l_i \cup C_i$ converges to p in \mathcal{D} .

Case 2 Up to subsequence, for any distinct i, j , the l_i is separated from l_j .

Let $V = \mathcal{O} - \bigcup_{i \in \mathbb{N}} (C_i \cup l_i)$, an open set in \mathcal{O} . The procedure will be to inductively construct leaves g_n so that either the sequence $(g_n), n \in \mathbb{N}$ is nested with n and escapes compact sets in \mathcal{O} or is a sequence of nonseparated leaves. There are various possibilities for the limiting behavior of (g_j) which will eventually lead to a proof that $(l_i \cup C_i)$ converges in \mathcal{D} .

Given x in \mathcal{O} consider the line leaves b of \mathcal{O}^s which separate x from ALL of the l_i . For example given y not in the union of $l_i \cup C_i$, then $\mathcal{O}^s(y)$ is disjoint from this union – this is because no prong of $\mathcal{O}^s(z_i)$ is contained in V . For any x in a complementary region of $\mathcal{O}^s(y)$ not intersecting this union will have such line leaves b . A singular leaf has at most two line leaves with this property. The collection of line leaves b as above is clearly ordered by separation properties so we can index then as $\{b_\alpha \mid \alpha \in J\}$ where J is an index set. Put an order in J so that $\alpha < \beta$ if and only if b_α separates some point in b_β from x . Equivalently b_β separates some point in b_α from x . Two such line leaves in the same stable leaf may share the singular point or a half leaf. Since the b_α cannot escape \mathcal{O} as α increases (they are bounded by all the l_i) then the $\{b_\alpha\}$ limits to a collection of leaves of \mathcal{O}^s as α grows without bound.

There are 2 options: (1) There are infinitely many line leaves s_n of \mathcal{O}^s in the limit of the b_α so that for each n there is i_n with s_n either equal to l_{i_n} or separating l_{i_n} from every b_α . (2) There is one line leaf s of \mathcal{O}^s in the limit of the b_α so that this single s separates infinitely many of the l_i from all of the g_α . Notice that only option (2) can happen when there are no perfect fits.

Consider first option (1). The collection of leaves nonseparated from the s_n is infinite. Because the l_i are ordered it now follows that each s_n can separate only finitely many of the l_i from all of the b_α . Let p be the ideal point given by [Lemma 3.27](#) associated to the direction of the s_n with n increasing. The proof of [Lemma 3.27](#) implies that $(l_i \cup C_i)$ converges to p .

Now consider option (2). Let $g_0 = s$. The leaf t of \mathcal{O}^s containing s may have singularities. By the condition of pairwise disjointness of the $l_i \cup C_i$, there is a single line leaf g_1 of t with a complementary component o_1 in \mathcal{O} which contains l_i for all $i \geq i_0$. We will restart the process with the $\{l_i\}, i \geq i_0$, instead of the original sequence. We will remember g_0 and the leaf g_1 which separates x from all $l_i \cup C_i, i \geq i_0$.

Restart the process as follows. Throw out all the leaves until l_{i_0} and redo the process. This iterative process produces $(g_j), j \in \mathbb{N}$ which is a weakly nested sequence of line

leaves. We explain the weak behavior. For instance in the first case, after throwing out l_1 (or whatever first leaf was still present), it may be that only g_1 is a slice which separates x from all other l_i ; see Figure 12(b). In that case $g_2 = g_1$. So the g_j may be equal, but they are weakly monotone with j .

If the (g_j) escapes in \mathcal{O} with j then it defines a point p in $\partial\mathcal{O}$. Since each g_j separates infinitely many l_i from x we quickly obtain as before that the l_i converge to the point p in $\partial\mathcal{O}$.

Suppose then that the (g_j) does not escape in \mathcal{O} . The first option is that there are infinitely many distinct g_j . Up to taking a subsequence assume all g_j are distinct and let g_j converge to $H = \cup h_k$, a collection of line leaves of \mathcal{O}^s . By construction, for each j_0 , the g_{j_0} separates some l_i from x but for a bigger j , the g_j does not separate l_i from x ; see Figure 12(a). Also, for each i there is some j so that g_j separates l_i from x . In particular there is a component of $\mathcal{O} - H$ which contains all the l_i .

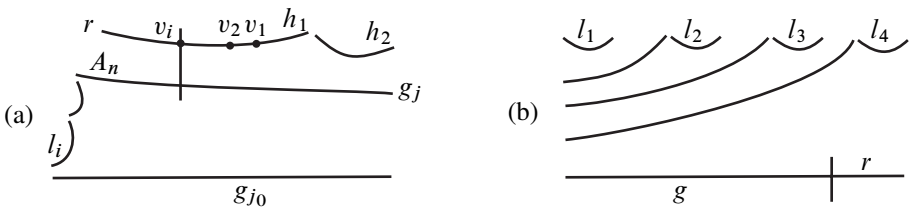

Figure 12. (a) Forcing convergence on one side (b) The case that all g_j are equal.

We analyze the case there are finitely many line leaves of \mathcal{O}^s in H , the other case being similar. As seen in Theorem 2.6 the set of leaves in H is ordered and we choose h_1 to be the leaf closest to the l_i . Also there is a ray r of l which points in the direction of the l_i ; see Figure 12(a). Let p be the ideal point of r in $\partial\mathcal{O}$. We want to show that $l_i \cup C_i$ converges to p .

Choose points v_n in r converging to p . For each n then $\mathcal{O}^u(v_n)$ intersects g_j for j big enough, since the sequence g_j converges to H . Choose one such $g_{j(n)}$ with $j(n)$ converging to infinity with n . We consider a convex set A_n of \mathcal{O} bounded by a subray of r starting at v_n , a segment in $\mathcal{O}^u(v_n)$ between h_1 and $g_{j(n)}$ and a ray in $g_{j(n)}$ starting in $g_{j(n)} \cap \mathcal{O}^u(v_n)$ and going in the direction of the l_i ; see Figure 12(a). We can choose $j(n)$ so that the $(A_n), n \in \mathbb{N}$ forms a nested sequence. Let $a_n = \partial A_n$. Since h_1 is the first element of H it follows that (a_n) escapes compact sets in \mathcal{O} and clearly it converges to p in $\mathcal{O} \cup \partial\mathcal{O}$. For each n and associated j , there is i_0 so that for $i > i_0$ then g_j separates l_i from x . It follows that $l_i \cup C_i$ is contained in A_n and therefore $(l_i \cup C_i)$ converges to p in \mathcal{D} . This finishes the proof in this case.

If H is infinite let $H = \{h_k, k \in \mathbf{Z}\}$ with k increasing as h_k moves in the direction of the l_i . Then h_i converges to a point $p \in \mathcal{O}$. A similar analysis as in the case that H is finite shows that $(l_i \cup C_i)$ converges to p in \mathcal{D} . Use the convex chains $a_j \cup b_j$ as described in Lemma 3.27.

The final case to be considered is that up to subsequence all g_i are equal and let g be this leaf. In particular no l_i is equal to g . This can certainly occur as shown in Figure 12(b). If we remove finitely many of the l_i , then g is still the farthest leaf separating x from all the remaining l_i . Notice also that g is a line leaf on the side containing all the l_i .

Consider the collection of leaves \mathcal{B} of \mathcal{O}^s nonseparated from g in the side of g containing the l_i . Let W be the component of $\mathcal{O} - \mathcal{B}$ which accumulates on all of \mathcal{B} if $\mathcal{B} \neq \{g\}$ and otherwise let W be the component of $\mathcal{O} - \{g\}$ not containing x .

One possibility is that there are infinitely many i so that l_i is separated from g by an element in \mathcal{B} . Here we have 2 options. The first option is that there are infinitely many distinct elements e in \mathcal{B} for which there is some l_i with e separating l_i from g ; see Figure 13(a). Since the l_i are nested then as seen before this implies that the $l_i \cup C_i$ converge to some p in $\partial\mathcal{O}$. The second option here is that there is some fixed h' in \mathcal{B} which separates infinitely many l_i from g . As the sequence (l_i) is nested, this is true for all $i \geq i_0$ for some i_0 . But then h' would eventually take the place of g in the iterative process, that is, some $g_k = h'$ instead of $g_k = g$. Then g_k is not eventually constant and this was dealt with previously.

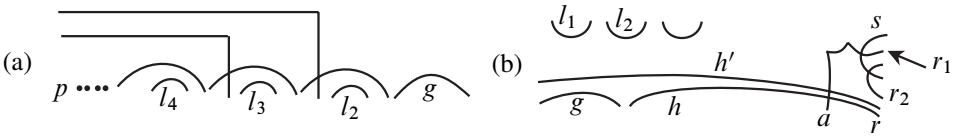

Figure 13. (a) The l_i flip to the other side of a leaf nonseparated from g (b) Convex neighborhood disjoint from all

The remaining case is that after throwing out a few initial terms we may assume that all l_i are contained W ; see Figure 13(b). Fix an embedded arc γ from g to l_1 intersecting them only in boundary points and not intersecting any other l_i . Let T be the component of $\mathcal{O} - (g \cup \gamma \cup l_1)$ containing all other l_i . Put an order in \mathcal{B} so that elements of \mathcal{B} contained in T are bigger than g in this order. For simplicity assume that \mathcal{B} is finite. The case where there are infinitely many leaves nonseparated from g on that side is very similar with proof left to the reader. Let h be the biggest element of \mathcal{B} , which could be g itself. Let r be the ray of h associated to the increasing direction of the l_i and let p in $\partial\mathcal{O}$ be the ideal point of r . We want to show that $(l_i \cup C_i)$ converges to p .

Let A be an arbitrary convex neighborhood of p in \mathcal{D} bounded by a convex chain a ; see Figure 13(b). If A is small enough then a has a ray r_1 contained in T . The

rays r, r_1 are not equivalent. Let h' be a leaf of \mathcal{O}^s in W sufficiently close to g . Because h is the biggest element in the ordered set \mathcal{B} then h' has to have a ray contained in A . For h' close enough to g , since the l_i are in T , then for some i_0 the leaf h' separates $l_i, 1 \leq i \leq i_0$, from g and hence from x . By the maximality property of g , then for some j the leaf h' does not separate l_j from g . Since l_j is in T this forces l_j to be contained in A . As the $\{l_i, i \in \mathbf{N}\}$ forms an ordered collection this forces l_i to be contained in A for all $i \geq j$. Since A was an arbitrary neighborhood of p this shows that $(l_i \cup C_i)$ converges to p in \mathcal{D} .

This finishes the proof of [Lemma 3.28](#). □

Proposition 3.29 *The space \mathcal{D} is compact.*

Proof Since \mathcal{D} is metrizable, it suffices to consider the behavior of an arbitrary sequence z_i in \mathcal{D} . We analyze all possibilities and in each case show there is a convergent subsequence.

Up to taking subsequences there are 2 cases:

Case 1 Assume the z_i are all in \mathcal{O} .

If there is a subsequence of z_i in a compact set of \mathcal{O} , then there is a convergent subsequence as $\mathcal{O} \cong \mathbf{R}^2$. So assume from now on that z_i escapes compact sets in \mathcal{O} . Let $b_i = \mathcal{O}^s(z_i)$. Suppose first there is a subsequence (b_{i_k}) converging to b and assume that all b_{i_k} are in one sector of b or in b itself. If a subsequence of (b_{i_k}) is constant and hence equal to b then up to another subsequence the z_i converges in \mathcal{D} to one of the ideal points of b , done. Otherwise a small transversal to b in a regular unstable leaf intersects b_{i_k} for k big enough and up to subsequence assume all z_{i_k} are in one side of that unstable leaf. Suppose for simplicity there are only finitely many leaves nonseparated from b in the side containing the b_i . Let b' be the last one nonseparated from b in the side the b_{i_k} are in and let p be the ideal point of b' in that direction. The argument is similar to one in [Case 2 of Lemma 3.28](#): let v_n in b' converging to p in $\partial\mathcal{O}$ with $\mathcal{O}^u(v_n)$ regular. Choose a convex polygonal path a_n made up of the ray in b' starting in v_n and converging to p , then the segment in $\mathcal{O}^u(v_n)$ from v_n to $\mathcal{O}^u(v_n) \cap b_{i_k}$ for appropriately big k and then a ray in b_{i_k} starting in this point. As before we can choose the \tilde{a}_n nested with n and so that $(\tilde{a}_n \cup a_n)$ escapes compact sets in \mathcal{O} , so converges to p in \mathcal{D} . It follows that z_{i_k} converges to p and we are done in this case. The case of infinitely many leaves nonseparated from l is treated similarly to what is done in the proof of [Lemma 3.28](#).

Suppose now that the sequence $(b_i), i \in \mathbf{N}$, escapes compact sets in \mathcal{O} . The goal is to reduce this case to a situation where we can apply [Lemma 3.28](#). Fix a base point x

in \mathcal{O} and assume that x is not in any b_i . Let l_i be the line leaf of b_i (so l_i is a line leaf of \mathcal{O}^s) which is the boundary of the component of $\mathcal{O} - b_i$ containing x . Let C_i be the component of $\mathcal{O} - l_i$ not containing x . If b_i is regular then C_i is a component of $\mathcal{O} - b_i$. If b_i is singular then $C_i \cup l_i$ contains all the prongs of b_i . In this case it follows that C_i escapes compact sets in \mathcal{O} . If there is a subsequence (l_{i_k}) so that (l_{i_k}) is nested then this defines an admissible sequence of convex polygonal paths (of length one) converging to an ideal point p .

Otherwise there has to be i_1 so that there are only finitely many i with $C_i \subset C_{i_1}$. Choose $i_2 > i_1$ with $C_{i_2} \not\subset C_{i_1}$ and hence $C_{i_2} \cap C_{i_1} = \emptyset$ and also so that there are finitely many i with $C_i \subset C_{i_2}$. In this way we construct a subsequence $i_k, k \in \mathbf{N}$ with C_{i_k} disjoint from each other. The collection of line leaves

$$\{l_{i_k} \mid k \in \mathbf{N}\}$$

is circularly ordered and if we remove one element of the sequence (say the first one) then it is linearly ordered. As such it can be mapped injectively into the set of rational numbers \mathbf{Q} in an order preserving way. Therefore there is another subsequence (call it still (l_{i_k})) for which the set $\{l_{i_k}\}$ is now linearly ordered with k , either increasing or decreasing. We can now apply Lemma 3.28 to the sequence l_{i_k} and obtain that (l_{i_k}) converges to a point p in $\partial\mathcal{O}$ and hence so does z_{i_k} . It was crucial here that $C_i \cup l_i$ contains all the prongs of b_i in order to apply Lemma 3.28.

This finishes the analysis of Case 1.

Case 2 Suppose the z_i are in $\partial\mathcal{O}$.

We use the analysis of Case 1. We may assume that the points z_i are pairwise distinct. To start we can find a convex polygonal path a_1 so that \bar{U}_{a_1} contains a neighborhood of z_1 in \mathcal{D} and also it does not contain any other z_i . Otherwise there is a subsequence of (z_i) which converges to z_1 . Inductively construct a_i convex polygonal paths with \bar{U}_{a_i} a neighborhood of z_i in \mathcal{D} and the $\{\bar{U}_{a_j}\}, 1 \leq j \leq i$ pairwise disjoint. By taking smaller convex neighborhoods we can assume that the (U_{a_i}) escapes compact sets in \mathcal{O} as $i \rightarrow \infty$. As in Case 1 we may assume up to subsequence that the $\{a_i \mid i \in \mathbf{N}\}$ forms an ordered set of \mathcal{O} with the order given by i . Let w_i be a point in a_i . Since a_i escapes compact sets in \mathcal{O} , Case 1 implies that there is a subsequence w_{i_k} converging to a point p in $\partial\mathcal{O}$. Consider a master sequence $B = (b_j)$ associated to p . Let j be an integer. If for all k we have that $\tilde{a}_{i_k} \not\subset \tilde{b}_j$, then \tilde{a}_{i_k} has a point w_{i_k} converging to p and also has points outside \tilde{b}_j . This contradicts the \tilde{a}_{i_k} being all disjoint since they are convex. Therefore $\tilde{a}_{i_k} \subset \tilde{b}_j$ for k big enough – this follows because the sequence (a_{i_k}) is ordered as a subset of \mathcal{O} . In fact by increasing the index if necessary then $U_{a_{i_k}} \subset \text{closure}(\tilde{b}_j)$ in \mathcal{D} . Since z_{i_k} is in $U_{a_{i_k}}$ this shows that $z_{i_k} \rightarrow p$. Therefore

there is always a subsequence of the original sequence which converges to a point in $\partial\mathcal{O}$.

This finishes the proof of [Proposition 3.29](#), compactness of \mathcal{D} . \square

We now prove a couple of additional properties of \mathcal{D} .

Proposition 3.30 *The space $\partial\mathcal{O}$ is homeomorphic to a circle.*

Proof The space $\partial\mathcal{O}$ is metrizable and circularly ordered. Also $\partial\mathcal{O}$ is compact, being a closed subset of a compact space, since \mathcal{O} is open in \mathcal{D} . We now show that $\partial\mathcal{O}$ is connected, no points disconnect the space and any two points disconnect the space.

Let p, q be distinct points in $\partial\mathcal{O}$. Choose disjoint convex neighborhoods $\overline{U}_a, \overline{U}_b$ of p, q defined by convex polygonal paths a, b . There are ideal points of \mathcal{O} in \overline{U}_a distinct from p , hence there is a point in $\partial\mathcal{O}$ between p, q . Hence any “interval” in \mathcal{O} is a linear continuum, being compact and satisfying the property that between any two points there is another point. This shows that $\partial\mathcal{O}$ is connected and also that no point in $\partial\mathcal{O}$ disconnects it. In addition as $\partial\mathcal{O}$ is circularly ordered, then any two points disconnect $\partial\mathcal{O}$. By Theorem I.11.21 of Wilder [67, page 32], the space $\partial\mathcal{O}$ is homeomorphic to a circle. \square

We are now ready to prove that \mathcal{D} is homeomorphic to a disk.

Theorem 3.31 *The space $\mathcal{D} = \mathcal{O} \cup \partial\mathcal{O}$ is homeomorphic to the closed disk D^2 .*

Proof The proof will use classical results of general topology, namely a theorem of Zippin characterizing the closed disk D^2 ; see Wilder [67, Theorem III.5.1, page 92].

First we need to show that \mathcal{D} is a Peano continuum; see Wilder [67, page 76]. A Hausdorff topological space C is a *Peano space* if it is not a single point, it is second countable, normal, locally compact, connected and locally connected. Notice that Wilder uses the term perfectly separable [67, definition on page 70] instead of second countable. If in addition C is compact then C is a *Peano continuum*.

By [Proposition 3.29](#) our space \mathcal{D} is compact, hence locally compact. It is also Hausdorff ([Lemma 3.19](#)), hence normal. By [Lemma 3.24](#) it is second countable and it is clearly not a single point. What is left to show is that \mathcal{D} is connected and locally connected.

We first show that \mathcal{D} is connected. Suppose not and let A, B be a separation of \mathcal{D} . Since $\partial\mathcal{O}$ is connected (this is done in the proof of [Proposition 3.30](#)), then $\partial\mathcal{O}$ is contained in either A or B , say it is contained in A . Then B is contained in \mathcal{O} . If

$B \neq \mathcal{O}$, then $B, A \cap \mathcal{O}$ disconnect \mathcal{O} , contrary to $\mathcal{O} \sim \mathbf{R}^2$. If $B = \mathcal{O}$, then $A = \partial\mathcal{O}$ and so \mathcal{O} is closed in $\mathcal{O} \cup \partial\mathcal{O}$, which is not true. It follows that \mathcal{D} is connected.

Next we show that \mathcal{D} is locally connected. Since $\mathcal{O} \cong \mathbf{R}^2$, then \mathcal{D} is locally connected at every point of \mathcal{O} . Let p in $\partial\mathcal{O}$ and let W be a neighborhood of p in \mathcal{D} . If $A = (a_i)$ is a master sequence associated to p , there is i with $\overline{U_{a_i}}$ contained in W and U_{a_i} is a neighborhood of p in \mathcal{D} . Now $U_{a_i} \cap \mathcal{O} = \tilde{a}_i$ is homeomorphic to \mathbf{R}^2 also and hence connected. The closure of \tilde{a}_i in \mathcal{D} is $\overline{U_{a_i}}$. Since

$$\tilde{a}_i \subset U_{a_i} \subset \overline{U_{a_i}}$$

we have that U_{a_i} is connected. This shows that \mathcal{D} is locally connected and hence that \mathcal{D} is a Peano continuum.

To use [67, Theorem III.5.1] we need the idea of spanning arcs. An arc in a topological space X is a subspace homeomorphic to a closed interval in \mathbf{R} . Let ab denote an arc with endpoints a, b . If K is a point set, we say that ab spans K if $K \cap ab = \{a, b\}$. We now state [67, Theorem III.5.1].

Theorem 3.32 (Zippin) *A Peano continuum C containing a 1–sphere J and satisfying the following conditions below is a closed 2–disk with boundary J :*

- (i) C contains an arc that spans J .
- (ii) Every arc that spans J separates C .
- (iii) No closed proper subset of an arc spanning J separates C .

Here E separates C mean that $C - E$ is not connected.

In our case J is $\partial\mathcal{O}$. For condition (i) let l be a nonsingular leaf in \mathcal{O}^s or \mathcal{O}^u . Then l has 2 ideal points in $\partial\mathcal{O}$ which are distinct. The closure \bar{l} is an arc that spans $\partial\mathcal{O}$. This proves (i).

We prove (ii). Let ζ be an arc in \mathcal{D} spanning $\partial\mathcal{O}$. Then $\zeta \cap \mathcal{O}$ is a properly embedded copy of \mathbf{R} in \mathcal{O} . Hence $\mathcal{O} - (\zeta \cap \mathcal{O})$ has exactly two components A_1, B_1 . In addition $\partial\mathcal{O} - (\zeta \cap \partial\mathcal{O})$ has exactly two components A_2, B_2 and they are connected, since $\partial\mathcal{O}$ is homeomorphic to a circle by Proposition 3.30. If p is in A_2 and $A = (a_i)$ is a master sequence for p , then by definition of the topology in \mathcal{D} there is i so that $U = U_{a_i}$ is disjoint from ζ as ζ is closed in \mathcal{D} and $p \notin \zeta$. Then $U \cap \mathcal{O} = U_{a_i} \cap \mathcal{O} = \tilde{a}_i$ is connected. Hence $U \cap \mathcal{O}$ is contained in either A_1 or B_1 . This also shows that a small neighborhood of p in $\partial\mathcal{O}$ will be contained in either A_2 or B_2 . By connectedness of A_2, B_2 , then after switching A_1 with B_1 if necessary it follows that: for any $p \in A_2$ there is a neighborhood U of p in \mathcal{D} with $U \cap \zeta = \emptyset$ and $U \cap \mathcal{O} \subset A_1$. Similarly

B_2 is paired with B_1 . Let $A = A_1 \cup A_2$ and $B = B_1 \cup B_2$. The arguments above show that A, B are open in \mathcal{D} and therefore they form a separation of $\mathcal{D} - \zeta$. This proves (ii).

Since $\mathcal{O} - (\zeta \cap \mathcal{O})$ has exactly two components A_1, B_1 then $\zeta \cap \mathcal{O}$ is contained in $\bar{A}_1 \cap \bar{B}_1$ and so $\zeta \subset \bar{A} \cap \bar{B}$. It follows that no proper subset of ζ separates \mathcal{D} . This proves property (iii).

Now Zippin's theorem implies that \mathcal{D} is homeomorphic to a closed disk. This finishes the proof of [Theorem 3.31](#). \square

Notice that $\pi_1(M)$ acts on \mathcal{O} by homeomorphisms. The action preserves the foliations $\mathcal{O}^s, \mathcal{O}^u$ and also preserves convex polygonal paths, admissible sequences, master sequences and so on. Hence $\pi_1(M)$ also acts by homeomorphisms on \mathcal{D} . The next result will be very useful in the following section.

Proposition 3.33 *Let Φ be a pseudo-Anosov flow in M^3 closed. Let p be an ideal point of \mathcal{O} . Then one of the 3 mutually exclusive options occurs:*

- (1) *There is a master sequence $L = (l_i)$ for p where l_i are slices in leaves of \mathcal{O}^s or \mathcal{O}^u .*
- (2) *p is an ideal point of a ray l of \mathcal{O}^s or \mathcal{O}^u so that l makes a perfect fit with another ray of \mathcal{O}^s or \mathcal{O}^u . There are master sequences which are standard sequences associated to the ray l in \mathcal{O}^s or \mathcal{O}^u as described in [Definition 3.8](#).*
- (3) *p is a corner of a scalloped region as described in [Section 2](#). Then a master sequence for p is obtained as described in [Lemma 3.27](#).*

In addition the only conclusion that applies if there are no perfect fits is conclusion (1).

Proof The point $p \in \mathcal{O}$ is fixed in this proof. We first show that Cases (1)–(3) are mutually exclusive. Case (2) it is disjoint from Case (1). This is because any master sequence $E = (e_i)$ in Case (2) has to have \tilde{e}_i containing part of a fixed perfect fit for i big enough. In particular the polygonal paths e_i have to have at least 2 sides for i big enough, so this cannot be Case (1). Suppose now that p is a point of type (3). Consider a master sequence $D = (d_i)$ where $d_i = a_i \cup b_i$, a_i a ray in \mathcal{O}^u and b_i a ray in \mathcal{O}^s as described in [Lemma 3.27](#). Notice that all a_i intersect a common unstable leaf. If there is a master sequence $L = (l_j)$ as in (1) then the l_j have to weakly intercalate with the d_i . But then they have to separate leaves of \mathcal{O}^u intersecting a common leaf of \mathcal{O}^s and vice versa. This is impossible. The same argument can be used to rule out Case (2): consider a master sequence $E = (e_j)$ as in Case (2). The weak intercalation property

of d_i with this sequence implies that the polygonal paths e_j have to be eventually of length 2 and both leaves have to be leaves intersecting the scalloped region. Hence E is an admissible sequence as in Case (3) and does not converge to an ideal point of a ray l associated to a perfect fit.

Now we prove that one of options (1)–(3) has to occur. Fix a basepoint x in \mathcal{O} . Let $A = (a_i)$ be a master sequence defining p . Since $(a_i \cup \tilde{a}_i)$ escapes compact sets in \mathcal{O} , we may throw out a few initial terms if necessary and assume that x is not in the closure of any \tilde{a}_i . Each a_i is a convex polygonal path, $a_i = b_1 \cup \dots \cup b_n$ where b_j is either a segment or a ray in \mathcal{O}^s or \mathcal{O}^u . For simplicity we omit the dependence of the b_j 's on the index i .

Claim For each i there is some b_j as above, with b_j contained in a slice z of a leaf of \mathcal{O}^s or \mathcal{O}^u , so that z separates x from \tilde{a}_i .

In this claim i is fixed. Given j let y be an endpoint of b_j . Without loss of generality assume b_j is in a leaf of \mathcal{O}^s and y is in b_{j+1} also. Since a_i is a convex polygonal path, we can extend b_j along $\mathcal{O}^s(y)$ beyond y and entirely outside \tilde{a}_i . The hypothesis that \tilde{a}_i is convex is necessary, for otherwise at a nonconvex switch any continuation of b_j along $\mathcal{O}^s(y)$ would have to enter \tilde{a}_i . If one encounters a singular point in $\mathcal{O}^s(y)$ (which could be y itself), then continue along the prong closest to b_{j+1} . This produces a slice c_j of $\mathcal{O}^s(y)$ with $b_j \subset c_j$. There is a component V_j of $\mathcal{O} - c_j$ containing \tilde{a}_i . Since we choose the prong closest to b_{j+1} then

$$\bigcap_{j=1}^n V_j = \tilde{a}_i.$$

Since x is not in \tilde{a}_i , then there is at least one j with x not in V_j and so c_j separates x from \tilde{a}_i . Let z be this slice c_j . This proves the claim.

Using the claim then for each i produce such a slice and denote it by l_i . Let \tilde{l}_i be the component of $\mathcal{O} - l_i$ containing \tilde{a}_i . Up to subsequence assume all the l_i are in (say) \mathcal{O}^s . Since A is a master sequence for p , we may also assume, by Lemma 3.22, that all the l_i are disjoint from each other.

We now analyze what happens to the l_i . The first possibility is that the sequence (l_i) escapes compact sets in \mathcal{O} . Then this sequence defines an ideal point of \mathcal{O} . As $\tilde{a}_i \subset \tilde{l}_i$, it follows that $L = (l_i)$ is an admissible sequence for p and $A \leq L$. Since $A = (a_i)$ is a master sequence for p , then given \tilde{a}_i , there is $j > i$ with $l_j \cup \tilde{l}_j \subset \tilde{a}_i$ and so $L \leq A$. It follows that $L = (l_i)$ is also a master sequence for p . This is Case (1).

Suppose from now on that for *any* master sequence $A = (a_i)$ for p and *any* (l_i) as constructed above, then (l_i) does not escape compact sets of \mathcal{O} . Then (l_i) converges to a family of nonseparated line leaves in \mathcal{O}^s : $\mathcal{C} = \{c_k, k \in I \subset \mathbf{Z}\}$. If there are no perfect fits then \mathcal{C} is a singleton by [Theorem 2.6](#). Assume \mathcal{C} is ordered as described in [Theorem 2.6](#). Here I is either $\{1, \dots, k_0\}$ or is \mathbf{Z} .

Choose $x_i \in b_i = a_i \cap l_i$. These points will be used for the remainder of the proof. Since x_i is in a_i and (a_i) is a master sequence for p , the definition of the topology in \mathcal{D} ([Definition 3.15](#)) implies that (x_i) converges to the fixed point p in \mathcal{D} . Here we need to differentiate between the set \mathcal{C} of leaves and the set $\bigcup \mathcal{C}$ of points in the leaves in \mathcal{C} . For any y in $\bigcup \mathcal{C}$, then $y \in c_k$ for some k and $\mathcal{O}^u(y)$ intersects l_i for i big enough in a point denoted by y_i . Similarly for z in $\bigcup \mathcal{C}$ define $z_i = \mathcal{O}^u(z) \cap l_i$. This notation will be used for the remainder of the proof.

Situation 1 Suppose there are $y, z \in \bigcup \mathcal{C}$ so that for big enough i , x_i is between y_i and z_i in l_i .

We refer to [Figure 14\(a\)](#). Suppose that z is in c_{j_0} , y in c_{j_1} , with $j_0 \leq j_1$ in the given order of \mathcal{C} . If $j_0 = j_1$ then the segment u_i of l_i between z_i, y_i converges to the segment in $\mathcal{O}^s(z)$ between z and y . Then x_i does not escape compact sets, contradiction to $A = (a_i)$ being an admissible sequence.

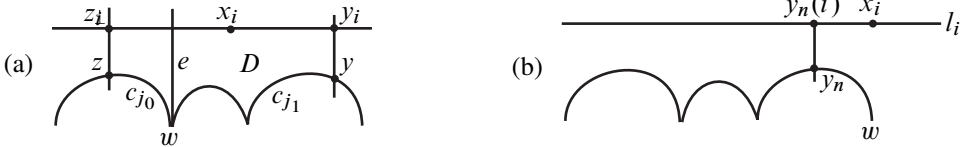

Figure 14. (a) The case that x_i is between some unstable leaves (b) The case that x_i escapes to one side

For any k the leaves c_k, c_{k+1} are nonseparated from each other and there is a leaf e of \mathcal{O}^u making perfect fits with both c_k and c_{k+1} . This defines an ideal point w of $\partial\mathcal{O}$ which is an ideal point of equivalent rays of c_k, c_{k+1} and e ; see [Figure 14\(a\)](#) ($k = j_0$ in the figure). Consider the open region D of \mathcal{O} bounded by the ray of c_{j_0} defined by z and going in the y direction, the segment in $\mathcal{O}^u(z)$ from z to z_i , the segment u_i in l_i from z_i to y_i , the segment in $\mathcal{O}^u(y)$ from y_i to y , the ray in $\mathcal{O}^s(y)$ defined by y and going towards the z direction and the leaves c_k with $j_0 < k < j_1$ (this last set is empty if and only if $j_1 = j_0 + 1$). By the remark above, the only ideal points of D in $\partial\mathcal{O}$, that is the set $\overline{D} \cap \partial\mathcal{O}$ (closure in \mathcal{D}), are those associated to the appropriate rays of c_k with $j_0 \leq k \leq j_1$. Since (x_i) converges to p which is in $\partial\mathcal{O}$, then p is one of these points. So p is an ideal point of a ray of \mathcal{O}^s or \mathcal{O}^u which makes a perfect fit with another leaf. There is a master sequence which is a standard sequence associated to p . This is Case (2) of the proposition.

Situation 2 For any y, z in $\bigcup \mathcal{C}$ the x_i is eventually not between the corresponding y_i, z_i .

Let $y \in \bigcup \mathcal{C}$. Then up to subsequence the x_i are in one side of y_i in l_i , say in the side corresponding to increasing k in the order of \mathcal{C} (this is in fact true for any big i as x_i converges in \mathcal{D}).

Suppose first that \mathcal{C} is an infinite collection of nonseparated leaves. Let w be the ideal point associated to the infinite collection \mathcal{C} and in the increasing direction of \mathcal{C} as in Lemma 3.27. We follow the notation of Lemma 3.27: let $d_m = a_m \cup b_m$ and let $D = (d_m)$ be a master sequence associated to w as described in Lemma 3.27. Fix m . Then x_i is eventually in \tilde{d}_m . Therefore x_i converges to w and it follows that $w = p$. Here we are in Case (3).

Finally suppose that \mathcal{C} is finite. Let w be the ideal point of the ray of c_{k_0} corresponding to the increasing direction in \mathcal{C} . Let y_n in c_{k_0} converging to w ; see Figure 14(b). Let

$$y_n(i) = \mathcal{O}^u(y_n) \cap l_i.$$

Fix n . Then eventually in i , the x_i is in the component of $l_i - y_n(i)$ in the w side; see Figure 14(b). Consider a standard sequence defining w so that: it is arbitrary in the side of $\mathcal{O} - c_{k_0}$ not containing x_i and in the other side we have an arc in $\mathcal{O}^u(y_n)$ from y_n to $y_n(i)$ and then a ray in l_i , which contains x_i for i big. Since c_{k_0} is the biggest element in \mathcal{C} , there is no leaf of \mathcal{O}^s nonseparated from c_{k_0} in that side of \mathcal{C}_{k_0} . Hence the l_i cannot converge (in \mathcal{O}) to anything on that side and those parts of l_i escape in \mathcal{O} . As the x_i are in these subarcs of l_i then $x_i \rightarrow w$ in \mathcal{D} and so $p = w$.

Let $r_n = \mathcal{O}^u(y_n)$. If r_n escapes compact sets in \mathcal{O} as $n \rightarrow \infty$, then it defines a master sequence for p and we are in Case (1). Otherwise r_n converges to some r making a perfect fit with c_{k_0} and we are in Case (2). This finishes the proof of Proposition 3.33. \square

4 Flow ideal boundary and compactification of the universal cover

For the remainder of the article, unless otherwise stated, we will only consider pseudo-Anosov flows without perfect fits, not conjugate to suspension Anosov flows. In this section we compactify the universal cover \tilde{M} with a sphere at infinity using only dynamical systems tools.

Lemma 4.1 (Model precompactification) *Let M be a closed 3-manifold with a pseudo-Anosov flow without perfect fits, not conjugate to suspension Anosov. There is a compactification $\mathcal{D} \times [-1, 1]$ of \tilde{M} which is a topological product.*

Proof Recall that \mathcal{D} is a compactification of the orbit space \mathcal{O} of $\tilde{\Phi}$ and \mathcal{D} is homeomorphic to a closed disk. Consider $\mathcal{D} \times [-1, 1]$ with the product topology. This is compact and homeomorphic to a closed 3-ball. The set \tilde{M} is homeomorphic to the interior of $\mathcal{D} \times [-1, 1]$ which is $\mathcal{O} \times (-1, 1)$. In fact choose a cross section $f_1: \mathcal{O} \rightarrow \tilde{M}$ and a homeomorphism $f_2: (-1, 1) \rightarrow \mathbf{R}$. This produces a homeomorphism

$$f: \mathcal{O} \times (-1, 1) \rightarrow \tilde{M}, \quad f(x, t) = \tilde{\Phi}_{f_2(t)}(f_1(x)).$$

Clearly the topology in \tilde{M} is the same as the induced topology from $\mathcal{O} \times (-1, 1)$. In this way \tilde{M} can be seen as an open dense subset of $\mathcal{D} \times [-1, 1]$ and $\mathcal{D} \times [-1, 1]$ is a compactification of \tilde{M} . \square

This construction is reminiscent of the one done by Cannon and Thurston [16] for fibrations. Notice that this construction works for any pseudo-Anosov flow, even with perfect fits.

Important remark We should stress that this precompactification $\mathcal{D} \times [-1, 1]$ is *far from natural*, because in general it is very hard to put a topology in $\partial\mathcal{O} \times (-1, 1)$ which is group equivariant. In other words the section $f_1: \mathcal{O} \rightarrow \tilde{M}$ is not natural at all. The interior of $\mathcal{D} \times [-1, 1]$ is homeomorphic to \tilde{M} and clearly $\pi_1(M)$ acts on this open set. The topology in $\mathcal{D} \times \{-1, 1\}$ is what you would expect, since it is homeomorphic to the topology of \mathcal{D} , which is group equivariant. But the topology in $\partial\mathcal{O} \times [-1, 1]$ is really not well defined. Using the section f_1 we can define a trivialization of $\partial\mathcal{O} \times [-1, 1]$, connecting it to $\tilde{M} \cong \mathcal{O} \times (-1, 1)$. The problem here is that given a covering translation h of \tilde{M} , there is no guarantee that it will extend continuously to $\partial\mathcal{O} \times (-1, 1)$ (but it does extend naturally and continuously to $\mathcal{D} \times \{-1, 1\}$). This problem is easily seen even in the case of suspension pseudo-Anosov flows. Instead of using the lift of a fiber as a section $\mathcal{O} \rightarrow \tilde{M}$, use a section which goes one step lower (with respect to the fiber) in certain directions. From the point of view of the new trivialization of $\mathcal{D} \times [-1, 1]$ certain covering translations will not extend to $\mathcal{D} \times [-1, 1]$.

But this will not be a problem for us, because we will collapse $\partial\mathcal{D} \times [-1, 1]$, identifying each vertical interval $\{z\} \times [-1, 1]$ (z in $\partial\mathcal{O}$) to a point. In fact one could have adjoined to \tilde{M} just the top and bottom $\mathcal{D} \times \{-1, 1\}$. However it is much easier to describe sets and neighborhoods in the $\mathcal{D} \times [-1, 1]$ model as above, making many arguments simpler. The topology of the quotient space will be completely independent of the chosen section/trivialization and will depend only on the pseudo-Anosov flow.

The compactification of \tilde{M} we desire will be a quotient of $\mathcal{D} \times [-1, 1]$, where the identifications occur only in the boundary sphere. First we work only in the boundary of $\mathcal{D} \times [-1, 1]$ and later incorporate \tilde{M} .

We will use a theorem of Moore concerning cellular decompositions. A decomposition G of a space X is a collection of disjoint nonempty closed sets whose union is X . There is a quotient space X/G and a map $\nu: X \rightarrow X/G$. The points of X/G are just the elements of G . The point $\nu(x)$ is the unique element of G containing x . The topology in X/G is the quotient topology: a subset U of X/G is open if and only if $\nu^{-1}(U)$ is open in X .

A decomposition G of X satisfies the *upper semicontinuity property* provided that, given g in G and V open in X containing g , the union of those g' of G contained in V is an open set in X . Equivalently ν is a closed map.

A decomposition G of a closed 2-manifold B is *cellular*, provided that G is upper semicontinuous and provided each g in G is compact and has a nonseparating embedding in the Euclidean plane E^2 . The following result was proved by R L Moore for the case of a sphere:

Theorem 4.2 (Approximating cellular maps, Moore’s theorem) *Let G denote a cellular decomposition of a 2-manifold B homeomorphic to a sphere. Then the identification map $\nu: X \rightarrow X/G$ can be approximated by homeomorphisms. In particular X and X/G are homeomorphic.*

Theorem 4.3 (Flow ideal boundary) *Let Φ be a pseudo-Anosov flow in M^3 closed which is not topologically conjugate to a suspension Anosov flow and there are no perfect fits between leaves of $\tilde{\Lambda}^s, \tilde{\Lambda}^u$. Let $\mathcal{D} \times [-1, 1]$ be the model precompactification of \tilde{M} . Then $\partial(\mathcal{D} \times [-1, 1])$ has a quotient \mathcal{R} which is a 2-sphere where the group $\pi_1(M)$ acts by homeomorphisms. The space \mathcal{R} and its topology are completely independent of the model precompactification $\mathcal{D} \times [-1, 1]$ and depend only on the flow Φ .*

Proof The topology in $\mathcal{D} \times \{-1, 1\}$ is well defined by the obvious bijections $\mathcal{D} \rightarrow \mathcal{D} \times \{1\}, \mathcal{D} \rightarrow \mathcal{D} \times \{-1\}$. The structure of $\mathcal{O}^s \times \{1\}$ in $\mathcal{D} \times \{1\}$ is then equivalent to that of \mathcal{O}^s in \mathcal{D} , etc. . . . We will stress where needed that arguments are independent of parametrization/trivialization of $\partial\mathcal{O} \times (-1, 1)$.

We construct a cellular decomposition \mathcal{R} of $\partial\mathcal{D} \times [-1, 1]$ as follows. The cells are one of the following types:

(1) Let l be a leaf of \mathcal{O}^s with ideal points a_1, \dots, a_n in $\partial\mathcal{O}$. Consider the cell element

$$g_l = l \times \{1\} \cup \bigcup_{1 \leq i \leq n} a_i \times [-1, 1].$$

(2) Let l be a leaf of \mathcal{O}^u with ideal points b_1, \dots, b_m in $\partial\mathcal{O}$. Consider the cell element

$$g_l = l \times \{-1\} \cup \bigcup_{1 \leq i \leq n} b_i \times [-1, 1].$$

(3) Let z be a point of $\partial\mathcal{O}$ which is not an ideal point of a ray of \mathcal{O}^s or \mathcal{O}^u . Consider the cell element $g_z = z \times [-1, 1]$.

Later on we will think of \mathcal{R} as a set of points with the quotient topology induced by the map from $\partial(\mathcal{D} \times [-1, 1])$ to \mathcal{R} .

Since every point in \mathcal{O} is in a leaf of \mathcal{O}^s , then elements of type (1) cover $\mathcal{O} \times \{1\}$. Similarly elements of type (2) cover $\mathcal{O} \times \{-1\}$. Finally elements of type (3) cover the rest of $\partial\mathcal{O} \times [-1, 1]$. Cover here means the union contains the set in question. Under the hypothesis of no perfect fits, no two rays of \mathcal{O}^s or \mathcal{O}^u have the same ideal point. This implies that distinct elements of type (1), (2) or (3) are disjoint from each other. This defines the decomposition \mathcal{R} of $\partial(\mathcal{D} \times [-1, 1])$.

We now show that \mathcal{R} is a cellular decomposition of $\partial(\mathcal{D} \times [-1, 1])$. Any element of type (3) is homeomorphic to a closed interval, hence compact. An element g of type (1) is the union of finitely many closed intervals in $\partial\mathcal{O} \times [-1, 1]$ and a set $(l \cup \partial_\infty l) \times \{1\}$ in $\mathcal{D} \times \{1\}$. The set $l \cup \partial_\infty l$ (contained in \mathcal{D}) is homeomorphic to a compact k -prong in the plane. Therefore g is compact and homeomorphic to $l \cup \partial_\infty l$. In addition, any g in \mathcal{R} has a nonseparating embedding in the Euclidean plane.

Next we prove that \mathcal{R} is upper semicontinuous. Let g in \mathcal{R} and V an open set in $\partial(\mathcal{D} \times [-1, 1])$ containing g . Let V' be the union of the g' in \mathcal{R} with $g' \subset V$. We need to show that V' is open in $\partial(\mathcal{D} \times [-1, 1])$. Since g is arbitrary it suffices to show that V' contains an open neighborhood of g in $\partial(\mathcal{D} \times [-1, 1])$. We do the proof for elements of type (1) (see [Figure 15](#)), the other cases being very similar.

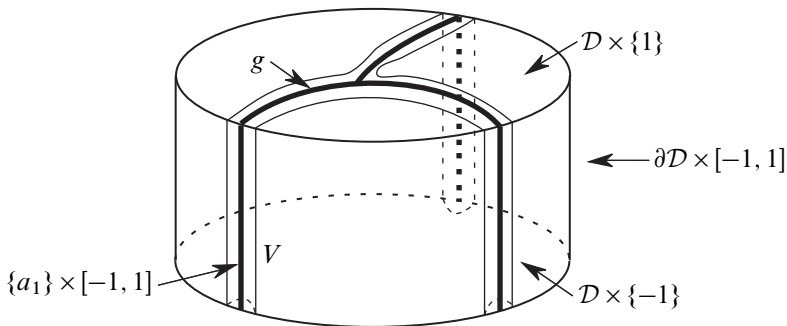

Figure 15. An element of g type (1) in $\partial\mathcal{D} \times [-1, 1]$ and a neighborhood of it

Let g be generated by the leaf l of \mathcal{O}^s , let a_1, \dots, a_n be the ideal points of l in $\partial\mathcal{O}$. For each i there is a neighborhood J_i of a_i in $\partial\mathcal{O}$ with $J_i \times [-1, 1]$ contained in V . This is because $\partial\mathcal{O} \times [-1, 1]$ is homeomorphic to a closed annulus. This conclusion is independent of the parametrization we choose for $\partial\mathcal{O} \times [-1, 1]$.

Let $(p_k)_{k \in \mathbb{N}}$ be a sequence of points in $\partial(\mathcal{D} \times [-1, 1])$ converging to some point p in g . Let g_k be the element of \mathcal{R} containing p_k . We show that for k big enough, then g_k is contained in V and therefore p_k has to be contained in V' . Hence V' contains an open neighborhood of g in $\partial\mathcal{D} \times [-1, 1]$. This will prove the upper semicontinuity property of the cellular decomposition.

Up to a subsequence we may assume that all p_k are either in (I) $\mathcal{O} \times \{1\}$, (II) $\mathcal{O} \times \{-1\}$ or (III) $\partial\mathcal{O} \times [-1, 1]$. We analyze each case separately:

Case I Suppose first that p_k is in $\mathcal{O} \times \{1\}$.

Hence $p_k \in \mathcal{D} \times \{1\}$. Up to subsequence and reordering $\{a_i\}$, assume that p_k are in a sector of $l \times \{1\}$ defined by $b \times \{1\}$ where b is a line leaf of l with ideal points a_1, a_2 . Then g_k is an element of type (1) and is the union

$$g_k = l_k \times \{1\} \cup \bigcup_j (\{w_{kj}\} \times [-1, 1]),$$

where $w_{kj}, 1 \leq j \leq j_0$ are the ideal points of l_k , a leaf of \mathcal{O}^s . Notice that g_k is contained in the set $(\mathcal{D} \times \{1\}) \cup (\partial\mathcal{O} \times [-1, 1])$.

We need the following result which is also useful later. It shows the strength of the no perfect fits hypothesis.

Lemma 4.4 (The escape lemma) *Let Φ be a pseudo-Anosov without perfect fits, not conjugate to a suspension Anosov flow.*

- (i) *Let $(l_n)_{n \in \mathbb{N}}$ be a sequence of leaves or slices of leaves of (say) \mathcal{O}^s . Suppose that (l_n) converges to a line leaf l of (say) \mathcal{O}^s . It follows that the ideal points of l_n converge to the ideal points of l .*
- (ii) *Under the hypothesis of (i), if $x_{n_k} \in l_{n_k}$ converges to x in \mathcal{D} , then x is in $l \cup \partial l$.*
- (iii) *Let l_n in \mathcal{O}^s or \mathcal{O}^u . Suppose there are x_n, y_n in $l_n \cup \partial l_n$ so that x_n, y_n converge to distinct points of $\partial\mathcal{O}$. Then l_n converges to a leaf l . In particular l_n does not escape compact sets in \mathcal{O} .*

Proof Suppose (i) is not true. Let p in l . Hence there is an ideal point a_1 of l in $\partial\mathcal{O}$ and there are r_n rays of l_n starting at p_n and in the direction of the ray in l with ideal point a_1 so that: $b_n = \partial r_n$ does not converge to a_1 . This also works up to subsequences. We may assume that (l_n) is nested. By separation properties b_n is

weakly monotone in $\partial\mathcal{O}$ and converges to a point $c \neq a_1$. Consider the interval (c, a_1) of $\partial\mathcal{O}$ not containing a_2 . Suppose first that this interval has an ideal point of a leaf e of \mathcal{O}^s or \mathcal{O}^u . The leaf e is a barrier for the leaves l_n , so this implies that l_n also converges to another leaf besides l . Since there are no perfect fits, this is impossible by [Theorem 2.6](#). We are left with the possibility that (c, a_1) does not have an ideal point of a leaf of \mathcal{O}^s or \mathcal{O}^u . But this is also impossible: let z in (c, a_1) . If z is ideal point of leaf of \mathcal{O}^s or \mathcal{O}^u we are done. Since there are no perfect fits, option (1) of [Proposition 3.33](#) has to occur and there is a neighborhood system of z defined by a sequence of stable leaves. This shows that any neighborhood of z in $\partial\mathcal{O}$ has points which are ideal points of leaves of \mathcal{O}^s . These arguments show that these ideal points of l_n converge to a_1 . This proves (i).

To prove (ii), up to taking a subsequence we assume the statement is for x_n in l_n . Since the leaf space of \mathcal{O}^s is Hausdorff, if x is in \mathcal{O} then x is in l . Suppose that x is in $\partial\mathcal{O}$. Using the notation from part (i) suppose that x_n are in the rays r_n as in part (i). Suppose that x_n does not converge to a_1 and instead converges to $c \neq a_1$. Let U, V small disjoint neighborhoods of a_1, c . By conclusion (i) already proved, for n big r_n has ideal point in U . Fix one such n and so r_n is entirely in U except for an initial compact segment t . For any $m > n$ the r_m is constricted to be in the union of two sets S_1 and S_2 : (1) S_1 the compact region of \mathcal{O} which is bounded by a polygon made of 4 arcs: (A) t , (B) a compact arc l' in l from p to a point in U , (C) a compact arc in U from the end of l' to the end of t and (D) a very small arc from the beginning of t to the beginning of l ; (2) the second set $S_2 = U$. Since (x_m) escapes compact sets in \mathcal{O} , then for big m , x_m cannot be in S_1 so it has to be in $S_2 = U$, contradiction to $x_m \in V$. This shows that x_i converges to a_1 .

To prove (iii), without loss of generality, assume that l_n are leaves of \mathcal{O}^s . Let x_n, y_n converging to distinct points x, y of $\partial\mathcal{O}$. If x_n is in $\partial\mathcal{O}$ one can choose a point in l_n arbitrarily near x_n , so we may assume that all x_n, y_n are in \mathcal{O} . Let r_n be the arc in l_n from x_n to y_n . If the sequence (r_n) escapes compact sets in \mathcal{O} , then it limits on at least one of the intervals (x, y) or (y, x) both of which are nondegenerate. But that would imply that this interval does not contain an ideal point of a ray of \mathcal{O}^s or \mathcal{O}^u – this was proved to be impossible in the proof of part (i). Since l_n does not escape compact sets in \mathcal{O} , there is a subsequence (l_{n_k}) and p_{n_k} in l_{n_k} with p_{n_k} converging to a point p in \mathcal{O} . Let l be the leaf of \mathcal{O}^s , with $p \in l$. Hence the sequence (l_{n_k}) converges to l (and to no other leaf when there are no perfect fits). Since x_{n_k} is in l_{n_k} and converges to x , part (ii) shows that x is an ideal point of l and so is y . Notice in addition that in the case of no perfect fits there is only one leaf of \mathcal{O}^s with ideal point x . But these arguments can be applied to *any* subsequence of (l_n) to show that such a subsequence has another subsequence converging to a leaf l' which has an ideal

point x . But as remarked before this implies that $l = l'$. It follows that the original sequence (l_n) has to converge to l . This finishes the proof of (iii). \square

Notice that conclusion (iii) is false for suspension Anosov flows.

Continuation of the proof of Theorem 4.3 Recall the setup in Case I: $p_k \in \mathcal{O} \times \{1\}$ converge to p in $g = g_l$. The p_k are in $l_k \times \{1\}$ with l_k all in a sector of b line leaf of l with ideal points a_1, a_2 ; V is a neighborhood of g in $\partial(\mathcal{D} \times [-1, 1])$. Let $p_k = y_k \times \{1\}$.

Case I.1 Suppose $p \in \mathcal{O} \times \{1\}$.

Then p_k converges to $p = y \times \{1\}$. By Lemma 4.4(ii) any limit point of x_{n_k} with x_{n_k} in l_{n_k} is in $b \cup \{a_1, a_2\}$. Hence $l_n \times \{1\} \subset V$ for n big. By Lemma 4.4(i), the ideal points of rays in l_k also converge to a_1 or a_2 and so $w_{k_j} \times [-1, 1] \subset V$ for k big. It follows that $g_k \subset V$ for k big in this case.

Case I.2 Suppose $p \in \partial\mathcal{O} \times \{1\}$.

Without loss of generality assume that p is $a_1 \times \{1\}$. In this case suppose first that (l_k) does not escape compact sets in \mathcal{O} . Assume up to subsequence that (l_k) converges to a line leaf s of \mathcal{O}^s . Then we may assume that l_k is nested. Since there are no perfect fits, there is only one such leaf s in the limit. As $p_k \in l_k \times \{1\}$, Lemma 4.4(ii) shows that the limit of y_k is an ideal point of a ray of s . This limit is a_1 so a_1 is an ideal point of s . This shows that s, l have rays with same ideal points. By definition the rays are equivalent. But since there are no perfect fits, then $s = l$. This reduces the proof to Case I.1.

Finally we suppose that (l_k) escapes compact sets in \mathcal{O} . Since there are p_k in $l_k \times \{1\}$ converging to $a_1 \times \{1\}$ we claim that $g_k \cap (\mathcal{D} \times \{1\})$ converges to $a_1 \times \{1\}$. Otherwise up to subsequence there are z_k in l_k with z_k converging to $v \neq a_1$. Hence l_k has arcs with endpoints in $y_k \rightarrow a_1$ and $z_k \rightarrow v$. The escape lemma (Lemma 4.4(i)) implies that l_k does not escape compact sets in \mathcal{O} , contradiction. This finishes the analysis of Case I.

The next case in the proof of Theorem 4.3 is:

Case II Suppose that p_k is in $\mathcal{O} \times \{-1\}$.

There is an asymmetry here because in Case I, g and g_k are cells to type (1), whereas in Case II, g is of type (1) and g_k is of type (2). So we cannot just revert the direction of the flow and use the proof of Case I to prove Case II.

In this case it follows that g_k is contained in $(\mathcal{D} \times \{-1\}) \cup (\partial\mathcal{O} \times [-1, 1])$. Since p_k converges to p in g and g is contained in $(\mathcal{D} \times \{1\}) \cup (\partial\mathcal{O} \times [-1, 1])$, it follows that p is in $\partial\mathcal{O} \times \{-1\}$ and p is say $(a_1, -1)$, where a_1 is one of the ideal points of l .

Here a_1 is an ideal point of a ray in \mathcal{O}^s and there are no perfect fits and no non-separated leaves of \mathcal{O}^s or \mathcal{O}^u . Therefore Proposition 3.33 shows that there is a neighborhood system of a_1 in \mathcal{D} defined by a sequence $(r_n)_{n \in \mathbb{N}}$ of unstable leaves (this is Proposition 3.33(1)). Since V is open in $\partial(\mathcal{D} \times [-1, 1])$, then for n big enough $r_n \times \{-1\}$ is contained in V . The element g_k is of the form

$$(s_k \times \{-1\}) \cup \bigcup_j (\{b_{kj}\} \times [-1, 1])$$

where the s_k are leaves of \mathcal{O}^u with points converging to a_1 . Since both r_n and s_k are unstable leaves, they cannot intersect transversely. It now follows that for k big enough $s_k \times \{-1\}$ is contained in V . There is an interval J in $\partial\mathcal{O}$ with a_1 in the interior of J and with $J \times [-1, 1] \subset V$ – this is because V is open and $a_1 \times [-1, 1]$ is contained in V . Hence the endpoints b_{jk} have to be in J for k big enough. It follows that g_k is entirely contained in V . This finishes the analysis of Case II.

Case III Suppose that p_k is in $\partial\mathcal{O} \times [-1, 1]$.

Then p_k converges to $p = (c, t)$ where c is in $\partial\mathcal{O}$. Hence V contains $J \times [-1, 1]$ for some interval J in $\partial\mathcal{O}$, so that J contains c in its interior. Here g_k can be type (1), (2) or (3). If g_k is of type (3) then for k big enough the g_k is contained in $J \times [-1, 1]$ and hence in V .

If g_k is of type (2), then it has vertical stalks $b_{kj} \times [-1, 1]$ which are eventually contained in $J \times [-1, 1]$. Hence b_{kj} is an ideal point of a leaf s_k in \mathcal{O}^u . As k varies, one of the ideal points of s_k (namely b_{kj}) converges to a_1 , which is an ideal point of l . The proof then proceeds as in Case II to show that eventually g_k is entirely contained in V .

Finally if g_k is of type (1), then as seen in Case I, g_k is contained in V for k big enough.

This proves that V' is open. We conclude that the decomposition satisfies the upper semicontinuity property. By Moore’s theorem it follows that \mathcal{R} is a sphere.

So far we have not really used the topology in $\partial\mathcal{O} \times [-1, 1]$. We still need to show that the topology of \mathcal{R} is independent of the choice of the trivialization $\partial\mathcal{O} \times [-1, 1]$ and that the fundamental group acts naturally by homeomorphisms on \mathcal{R} .

To see the first statement, notice that the quotient map $\partial(\mathcal{D} \times [-1, 1]) \rightarrow \mathcal{R}$ can be done in two steps: first collapse each vertical stalk $\{z\} \times [-1, 1]$ to a point where z is in $\partial\mathcal{O}$

and then do the remaining collapsing of leaves of \mathcal{O}^u in $\mathcal{D} \times \{-1\}$ and leaves of \mathcal{O}^s in $\mathcal{D} \times \{1\}$. After the first collapsing we have $\mathcal{D} \times \{1\}$ union $\mathcal{D} \times \{-1\}$ glued along the points $\{w\} \times \{-1, 1\}$. The topology now is completely determined since the topology on the top $\mathcal{D} \times \{1\}$ and the bottom $\mathcal{D} \times \{-1\}$ is completely determined by the topology in \mathcal{D} . The fundamental group acts by homeomorphisms in this object and preserves the foliations stable on the top and unstable on the bottom. Therefore the second collapse produces a sphere $\mathcal{R} = \partial(\mathcal{D} \times [-1, 1])/\mathcal{R}$. The topology in \mathcal{R} is independent of any choices. The fundamental group acts by homeomorphisms on the quotient space \mathcal{R} , since after the first collapse it acts by homeomorphisms and preserves the elements of the decomposition. This finishes the proof of the [Theorem 4.3](#). \square

We now show that the action of $\pi_1(M)$ in \mathcal{R} has excellent properties, that is, it is a uniform convergence group action. A topological space X is a *compactum* if it is a compact Hausdorff topological space. Let X be a compactum and Γ a group acting by homeomorphisms on X . Let $\Theta_3(X)$ be the space of distinct triples of X with the subspace topology induced from the product space $X \times X \times X$. Then $\Theta_3(X)$ is locally compact and there is an induced action of Γ on $\Theta_3(X)$. Here *local uniform convergence* means uniform convergence in compact sets. For simplicity we state results for X metrizable (in the general case one uses nets instead of sequences [\[8\]](#)). Notice we identify the group with the action.

Definition 4.5 [\[37\]](#) Γ is a convergence group if the following holds: If $(\gamma_i)_{i \in \mathbb{N}}$ is an infinite sequence of distinct elements of Γ , then one can find points a, b in X and a subsequence $(\gamma_{i_k})_{k \in \mathbb{N}}$ of (γ_i) , such that the maps $\gamma_{i_k}|_{X - \{a\}}$ converge locally uniformly to the constant map with value b .

Notice that it is not necessary that a, b are distinct, which in fact does not happen always. It is simple to see that this is equivalent to the following property: the action of Γ on $\Theta_3(X)$ is *properly discontinuous* [\[64; 8\]](#). This means that for any compact subset K of $\Theta_3(X)$, the set $\{\gamma \in \Gamma \mid \gamma K \cap K \neq \emptyset\}$ is finite [\[64; 8\]](#). The action of Γ is *cocompact* if $\Theta_3(X)/\Gamma$ is a compact space. If the action is a convergence group and cocompact it is called an *uniform convergence group action*.

Definition 4.6 (Conical limit points) Let Γ be a group action on a metrizable compactum X . A point z in X is a conical limit point for the action of Γ if there are distinct points a, b of X and a sequence $(\gamma_i)_{i \in \mathbb{N}}$ in Γ such that $\gamma_i z \rightarrow a$ and $\gamma_i y \rightarrow b$ for all y in $X - \{z\}$.

Here it is crucial that a, b are *distinct* for otherwise the convergence group property would yield the result for many points. Basic references for conical limit points are

Tukia [65] and Bowditch [8]. It is a simple result that if Γ is a uniform convergence group action then every point of X is a conical limit point [65; 8]. The opposite implication is highly nontrivial and was proved independently by Tukia [65] and Bowditch [7]. Recall that X is perfect if it has no isolated points.

Theorem 4.7 [65; 7] *Suppose that X is a perfect, metrizable compactum and that Γ is a convergence group action on X . If every point of X is a conical limit point for the action, then Γ is a cocompact action. Consequently Γ is a uniform convergence group action.*

Hence both properties of uniform convergence group action can be checked by analysing sequences of elements of Γ . Our main technical result is the following:

Theorem 4.8 *Let Φ be a pseudo-Anosov flow in M^3 closed so that Φ does not have perfect fits and is not topologically conjugate to a suspension Anosov flow. Consider the induced quotient \mathcal{R} of $\partial(\mathcal{D} \times [-1, 1])$ and the induced action of $\Gamma = \pi_1(M)$ on \mathcal{R} . Then Γ is a uniform convergence group.*

We first prove that $\pi_1(M)$ acts as a convergence group on \mathcal{R} using the sequences formulation and then we show that every point of \mathcal{R} is a conical limit point for the action of Γ on \mathcal{R} . The space \mathcal{R} is homeomorphic to a sphere, hence it is a perfect, metrizable compact space and [Theorem 4.7](#) can be used.

First we define an important map which will be used throughout the proofs in this section. Recall there is a continuous quotient map $v: \partial(\mathcal{D} \times [-1, 1]) \rightarrow \mathcal{R}$. Identify $\partial\mathcal{O}$ with $\partial\mathcal{O} \times \{1\}$ by $z \rightarrow (z, 1)$ in $\partial(\mathcal{D} \times [-1, 1])$. Then there is an induced map

$$(*) \quad \varphi: \partial\mathcal{O} \rightarrow \mathcal{R}, \quad \varphi(z) = v((z, 1)).$$

The map φ is continuous. Every g of \mathcal{R} contains intervals of the form $\{y\} \times [-1, 1]$ where $y \in \partial\mathcal{O}$, so φ is surjective. Hence φ encodes all of the information of the map v . In addition $\pi_1(M)$ acts on $\partial\mathcal{O}$. The proof will use deep knowledge about the action of $\Gamma = \pi_1(M)$ on the circle $\mathbf{S}^1 = \partial\mathcal{O}$ in order to obtain information about the action of Γ on \mathcal{R} .

Notice that the map φ is group equivariant producing examples of group invariant sphere filling curves.

Remarks (1) A very important fact is the following. Suppose that x, y distinct in $\partial\mathcal{O}$ are identified under φ , that is $\varphi(x) = \varphi(y)$. Because of the no perfect fits condition, there are no distinct leaves of $\mathcal{O}^s, \mathcal{O}^u$ sharing an ideal point in $\partial\mathcal{O}$. This

implies there is a leaf l of \mathcal{O}^s or \mathcal{O}^u so that x, y are ideal points of l . In particular there are at most k preimages under φ of any point, where k is the maximum number of prongs at a singular point of \mathcal{O}^s or \mathcal{O}^u .

(2) (Important convention) Recall that $\mathcal{H}^s, \mathcal{H}^u$ are the leaf spaces of $\tilde{\Lambda}^s, \tilde{\Lambda}^u$ respectively. If γ is an element of $\pi_1(M)$ then γ acts as a homeomorphism in all of the spaces $\tilde{M}, \mathcal{O}, \partial\mathcal{O}, \mathcal{R}, \mathcal{H}^s$ and \mathcal{H}^u . For simplicity, the same notation γ will be used for all of these homeomorphisms. The context will make it clear which case is in question. With this understanding, the fact that φ is group equivariant means that for any γ in $\pi_1(M)$ then

$$\gamma \circ \varphi = \varphi \circ \gamma$$

where the first γ acts on \mathcal{R} and the second acts on $\partial\mathcal{O}$. The reader should be aware that this convention will be used throughout this section.

Recall that if l is a ray or leaf of \mathcal{O}^s or \mathcal{O}^u , then ∂l denotes the ideal point(s) of l in $\partial\mathcal{O}$. Before proving [Theorem 4.8](#), we first show in the next 2 lemmas that for any γ in $\pi_1(M)$, the action of γ on $\partial\mathcal{O}$ and \mathcal{R} is as expected. In the first lemma we do not assume that there are no perfect fits.

Lemma 4.9 *Suppose that Φ is pseudo-Anosov flow not conjugate to suspension Anosov. Suppose there is no infinite collection of leaves of $\tilde{\Lambda}^s$ or $\tilde{\Lambda}^u$ which are all nonseparated from each other. Let γ in $\pi_1(M)$ with no fixed points in \mathcal{O} . Then the action of γ on $\partial\mathcal{O}$ either (1) has only 2 fixed points one attracting and one repelling and is of hyperbolic type or (2) it has a single fixed point in $\partial\mathcal{O}$, which is of parabolic type. In the second case, the fixed point of γ is a parabolic point in $\partial\mathcal{O}$ associated to a perfect fit horoball. Finally if there are no perfect fits only option (1) can occur.*

Proof If γ leaves invariant a leaf F in \mathcal{H}^s , then there is an orbit $\tilde{\alpha}$ in F with $\gamma(\tilde{\alpha}) = \tilde{\alpha}$. Then γ does not act freely on \mathcal{O} , contradiction.

The space \mathcal{H}^s is what is called a non-Hausdorff tree [26; 57]. Very roughly a non-Hausdorff tree is a “one-dimensional” space with a tree like behavior, except that one allows non-Hausdorff behavior. It is simply connected and is the union of countably many “segments”. Since γ acts freely on \mathcal{H}^s then [26, Theorem A] implies that γ has a translation axis for its action in \mathcal{H}^s . The transformation g leaves invariant this axis and acts as a translation on it. The points in the axis are exactly those leaves L of $\tilde{\Lambda}^s$ so that $\gamma(L)$ separates L from $\gamma^2(L)$. This implies that the $\{\gamma^n(L), n \in \mathbf{Z}\}$ form a nested collection of leaves.

As explained in [26], the axis does not have to be properly embedded in \mathcal{H}^s , that is, there may be a_n in the axis, escaping in the axis, but not escaping compact sets in the

leaf space \mathcal{H}^s . Let L be in the axis. If $(\gamma^n(L))_{n \in \mathbf{N}}$ does not escape compact sets in \mathcal{O} , then by the nested property, the $\gamma^n(L)$ converges to some F in $\tilde{\Lambda}^s$ as n converges to infinity. If $\gamma(F) = F$ we have an invariant leaf in $\tilde{\Lambda}^s$, contradiction. If $\gamma(F), F$ are distinct let \mathcal{B} be the set of leaves of $\tilde{\Lambda}^s$ nonseparated from F in the side the $\gamma^n(L)$ are limiting to. By [Theorem 2.6](#), the set \mathcal{B} is order isomorphic to either \mathbf{Z} or $\{1, \dots, j\}$ for some j . The first option is disallowed by hypothesis. Consider the second option. The transformation γ leaves \mathcal{B} invariant. If γ preserves the order in \mathcal{B} then as \mathcal{B} is finite, γ will have invariant leaves in $\tilde{\Lambda}^s$, contradiction. If γ reverses order in \mathcal{B} , then there are consecutive elements F_0, F_1 in \mathcal{B} which are swapped by γ . There is a unique unstable leaf E which separates F_0 from F_1 . This E makes a perfect fit with both F_0 and F_1 ; see [Theorem 2.6](#). By the above this leaf E is invariant under γ again leading to a contradiction. This argument shows that the axis of γ is properly embedded in \mathcal{H}^s .

Let L_0 be in the axis of γ acting on \mathcal{H}^s . As $\gamma(L_0)$ separates L_0 from $\gamma^2(L_0)$, there is a unique line leaf L of L_0 so that the sector defined by L contains $\gamma(L_0)$ (if L_0 is nonsingular then $L = L_0$). Recall that $\Theta: \tilde{M} \rightarrow \mathcal{O}$ is the projection map: it sends a point x in \tilde{M} to the orbit of $\tilde{\Phi}$ containing x . Then $(\gamma^n(\Theta(L)))_{n \in \mathbf{N}}$ is a nested sequence of convex polygonal paths, which escapes in \mathcal{O} . Hence this sequence defines a unique ideal point b in $\partial\mathcal{O}$. Similarly $(\gamma^{-n}(\Theta(L)))_{n \in \mathbf{N}}$ defines an ideal point a in $\partial\mathcal{O}$. Notice that

$$(**) \quad \gamma^n(\partial\Theta(L)) \rightarrow b \text{ as } n \rightarrow \infty \quad \text{and} \quad \gamma^n(\partial\Theta(L)) \rightarrow a \text{ as } n \rightarrow -\infty.$$

Clearly $\gamma(a) = a$, $\gamma(b) = b$. For any other z in $\partial\mathcal{O}$, then either z is an ideal point of some $\gamma^n(\theta(L))$ or z is in an interval of $\partial\mathcal{O}$ defined by ideal points of $\gamma^n(\Theta(L))$ and $\gamma^{n+1}(\Theta(L))$ for some n in \mathbf{Z} . It follows that property [\(**\)](#) above also holds for z .

If a, b are distinct then the above shows that a, b form a source/sink pair for γ and γ has hyperbolic dynamics in the circle $\partial\mathcal{O}$.

If $a = b$ then γ has parabolic dynamics in $\partial\mathcal{O}$ with a its unique fixed point. In addition $\Theta(L)$ has a ray l with ideal point a . The collection $\{\gamma^n(l)\}_{n \in \mathbf{Z}}$ of pairwise distinct rays all have ideal point a . By [Lemma 3.20](#) any two elements in this collection are connected by a chain of perfect fits. Then $\{\gamma^n(l)\}_{n \in \mathbf{Z}}$ is an infinite perfect fit and is associated to a perfect fit horoball. The perfect fit horoball is invariant under γ . This finishes the proof of the lemma. \square

Notice that if there are infinitely many leaves of $\tilde{\Lambda}^s$ or $\tilde{\Lambda}^u$ not separated from each other, then there are covering translations acting freely on \mathcal{O} and leaving invariant a scalloped region \mathcal{S} ; see [\[24\]](#). If γ is of this type then γ will fix the 4 ideal points in $\partial\mathcal{O}$ associated to the scalloped region \mathcal{S} . Hence the hypothesis in [Lemma 4.9](#) is needed

and this is the only additional possibility that can occur in general: if the $\gamma^n(L)$ does not escape compact sets for either $n \rightarrow \infty$ or $n \rightarrow -\infty$, then the proof in the lemma shows that $\gamma^n(L)$ converges to a bi-infinite collection of leaves nonseparated from each other. Let \mathcal{S} be the associated scalloped region. Here γ acts a translation in each collection of nonseparated leaves in $\partial\mathcal{S}$. It follows that γ has exactly 4 fixed points in $\partial\mathcal{O}$. Finally if γ has a fixed point in \mathcal{O} , then there are many more possibilities for the set of fixed points in $\partial\mathcal{O}$, in particular it can be infinite.

Lemma 4.10 *Suppose that Φ does not have perfect fits and is not conjugate to suspension Anosov. For each $\gamma \neq \text{id}$ in $\pi_1(M)$, there are distinct y, x in \mathcal{R} which are the only fixed points of γ in \mathcal{R} and x, y form a source/sink pair (y is repelling, x is attracting).*

Proof As with almost all the proofs in this section, the proof will be a strong interplay between the pseudo-Anosov dynamics action on $\partial\mathcal{O}$ and the induced action on \mathcal{R} . By Remark (1) on page 68 the only identifications of the map φ come from the ideal points of leaves of \mathcal{O}^s or \mathcal{O}^u .

Any γ in $\pi_1(M)$ has at most one fixed point in \mathcal{O} : if γ fixes 2 points in \mathcal{O} , then it produces 2 closed orbits of Φ which are freely homotopic to each other (or maybe freely homotopic to the inverse of each other or certain powers). By Theorem 2.5, the lifts of the closed orbits are connected by a chain of lozenges and this produces perfect fits in the universal cover, disallowed by hypothesis.

Suppose first that γ is associated to a periodic orbit of Φ – singular or not. Also γ need not correspond to an indivisible closed orbit. Let β be the orbit of $\tilde{\Phi}$ with $\gamma(\beta) = \beta$ and $b = \Theta(\beta)$ be the single fixed point of γ in \mathcal{O} . Suppose without loss of generality that γ is associated to an orbit of Φ being traversed in the forward direction. We will show that the set of fixed points of γ (or a power of γ) in $\partial\mathcal{O}$ is the union $\partial\mathcal{O}^s(b) \cup \partial\mathcal{O}^u(b)$ and also that $\partial\mathcal{O}^s(b)$ is the set of attracting fixed points for γ and $\mathcal{O}^u(b)$ is the set of repelling fixed points of γ .

Assume first that γ leaves invariant the prongs of $\mathcal{O}^u(b)$ and $\mathcal{O}^s(b)$ and that γ is nonsingular. Let c_1, c_2 in $\partial\mathcal{O}$ be the ideal points of $\mathcal{O}^s(b)$ and d_1, d_2 the ideal points of $\mathcal{O}^u(b)$; see Figure 16(a).

Notice that $\varphi(c_1) = \varphi(c_2)$ and similarly $\varphi(d_1) = \varphi(d_2)$. Let $x = \varphi(c_1), y = \varphi(d_1)$.

Clearly γ fixes c_1, c_2, d_1, d_2 . Let I be the interval of $\partial\mathcal{O}$ with endpoints c_1, d_1 and not containing d_2 . Since there are no perfect fits, then option (1) of Proposition 3.33 has to occur. As d_1 is an ideal point of an unstable leaf, then d_1 has a neighborhood

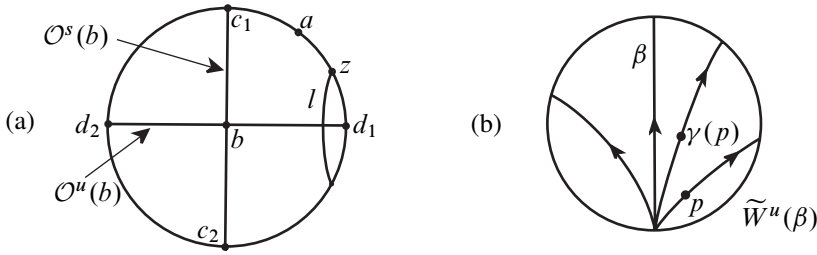

Figure 16. (a) The action of γ in \mathcal{D} and $\partial\mathcal{O}$. (b) Action of γ in $\tilde{W}^u(\beta)$

system in \mathcal{D} formed by stable leaves, all of which have to intersect $\mathcal{O}^u(b)$. Let l be one such leaf with ideal point z in I .

The action of γ in the set of orbits of $\tilde{W}^u(\beta)$ is contracting; see Figure 16(b). This is because γ is associated with the forward flow direction. Therefore $\gamma^n(l)$ converges to $\mathcal{O}^s(b)$ as n converges to infinity. It follows that $\gamma^n(z)$ converges to c_1 and so $\gamma^n(a)$ converges to c_1 . This shows that γ has only 2 fixed points in I and d_1 is repelling, c_1 is attracting. The other intervals of $\partial\mathcal{O}$ defined by $\partial\mathcal{O}^s(b) \cup \partial\mathcal{O}^u(b)$ are treated in the same fashion.

We claim that y, x form the source/sink pair for the action of γ in \mathcal{R} . Here

$$\gamma(x) = \gamma(\varphi(c_1)) = \varphi(\gamma(c_1)) = \varphi(c_1) = x,$$

and similarly γ fixes y . For any other w in \mathcal{R} there is z in $\mathcal{O} - \{c_1, c_2, d_1, d_2\}$ with $w = \varphi(z)$. Without loss of generality assume that z is in I . Then $\gamma^n(z)$ converges to c_1 and

$$\gamma^n(w) = \gamma^n(\varphi(z)) = \varphi(\gamma^n(z)) \rightarrow \varphi(c_1) = x.$$

Similarly $\gamma^n(w) \rightarrow y$ when $n \rightarrow -\infty$. So if γ leaves invariant the components of $\partial\mathcal{O} - \{c_1, c_2, d_1, d_2\}$ then y, x form a source/sink pair for the action of γ in \mathcal{R} .

In the general case take a power of γ so that in $\partial\mathcal{O}$ it fixes all points in $\partial\mathcal{O}^s(b), \partial\mathcal{O}^u(b)$ and preserves orientation in $\partial\mathcal{O}$. Then apply the above arguments. The arguments show that, as a set, $\partial\mathcal{O}^s(b)$ is invariant and attracting for the action of γ in $\partial\mathcal{O}$ and $\partial\mathcal{O}^u(b)$ is invariant and repelling for the action. All the points in $\partial\mathcal{O}^s(b)$ are mapped to x by φ and all points in $\partial\mathcal{O}^u(b)$ are mapped to y . Hence y, x is the source/sink pair for the action of γ in \mathcal{R} . This finishes the analysis of the case when γ does not act freely in \mathcal{O} .

We now analyze the case that γ acts freely in \mathcal{O} . The previous lemma produces a, b which are a source/sink pair for the action of γ on $\partial\mathcal{O}$. Since there are no perfect fits, the previous lemma shows that $a \neq b$. In fact the arguments of the previous lemma

show that none of a, b can be the ideal point of a ray of a leaf of \mathcal{O}^s or \mathcal{O}^u . Therefore $\varphi(a), \varphi(b)$ are also distinct.

Given L in the axis of γ in \mathcal{H}^s , let $l = \Theta(L)$. The ideal points of $\mathcal{O}^s(l)$ separate a from b in $\partial\mathcal{O}$. Then the source/sink property for the action of γ on $\partial\mathcal{O}$ immediately translates into a source/sink property for the action of γ on \mathcal{R} with source $\varphi(a)$ and sink $\varphi(b)$. This finishes the proof of [Lemma 4.10](#). \square

We now prove the first part of [Theorem 4.8](#).

Theorem 4.11 *Suppose that Φ does not have perfect fits and is not conjugate to a suspension Anosov flow. Then $\pi_1(M)$ acts on \mathcal{R} as a convergence group.*

Proof Let γ_i be a sequence of distinct elements of Γ . Up to subsequence we can assume that either

- (1) each γ_i is associated to a singular closed orbit of Φ ;
- (2) each γ_i is associated to a nonsingular closed orbit of Φ ;
- (3) each γ_i is not associated to a closed orbit of Φ .

Notice that (3) is equivalent to γ_i having no fixed points in the orbit space \mathcal{O} . There is some similarity between Cases (1) and (2) which will be explored as we go along the proof.

Case 1 Suppose the γ_i are all associated to singular orbits of the flow Φ .

Let α_i be orbits of $\tilde{\Phi}$ with $\gamma_i(\alpha_i) = \alpha_i$. There are only finitely many singular orbits of Φ , so we may assume up to subsequence that all $\pi(\alpha_i)$ are the same. We may also assume that γ_i are associated to (say) the positive flow direction of α_i , that is, if p_i is in α_i then $\gamma_i(p_i) = \tilde{\Phi}_{t_i}(p_i)$ with t_i bigger than zero. Let $x_i = \Theta(\alpha_i)$ and $l_i = \mathcal{O}^s(x_i)$.

Case 1.a (l_i) does not escape compact sets in \mathcal{O} .

It could be that, up to subsequence, l_i is constant. This means that there is γ in $\pi_1(M)$ so that $\gamma_i = \gamma^{n_i}$ and $|n_i|$ converging to ∞ . By the previous lemma there is a source/sink pair for the sequence (γ_i) .

Hence we may assume that up to subsequence all l_i are distinct and converge to a line leaf l of \mathcal{O}^s . Up to subsequence assume the l_i are nested and all in a fixed sector of l . Let u, v be the ideal points of l .

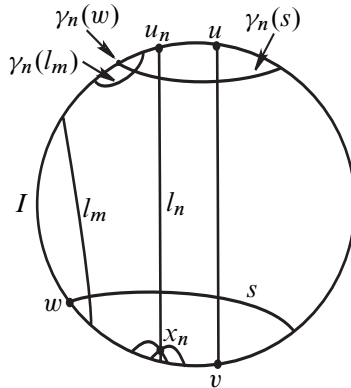

Figure 17. The case of line leaves converging to a limit

Claim 1 *There is an ideal point (say) v of l so that all ideal points of l_i except for one converge to v . The remaining ideal point of l_i converges to u .*

Otherwise up to subsequence there are at least 2 ideal points u_i^1, u_i^2 of l_i converging to u and likewise to v . Let x_i be the singular point of l_i . There is at least one *unstable* prong of $\mathcal{O}^u(x_i)$ with an ideal point in $\partial\mathcal{O}$ between u_i^1, u_i^2 very near u and similarly an unstable prong of $\mathcal{O}^u(x_i)$ with ideal point very near v . Their union is a slice s_i of $\mathcal{O}^u(x_i)$ with one ideal point near u and one ideal point near v . This slice is *not* a line leaf of $\mathcal{O}^u(x_i)$ since there are 2 prongs of $\mathcal{O}^s(x_i)$ on both sides of this slice. The sequence $(s_i)_{i \in \mathbb{N}}$ is nested and is bounded by l . Hence it converges to a leaf s of \mathcal{O}^u . By Lemma 4.4 the ideal points of s_i converge to the ideal points of s and hence s has ideal points u, v . But u is also an ideal point of the line leaf l of \mathcal{O}^s . Since there are no perfect fits, no leaves of $\mathcal{O}^s, \mathcal{O}^u$ share an ideal point. This proves Claim 1.

Since at least 2 ideal points of $\mathcal{O}^s(x_i)$ converge to v (as $i \rightarrow \infty$) and ideal points of $\mathcal{O}^s(x_i), \mathcal{O}^u(x_i)$ alternate in $\partial\mathcal{O}$, then at least one ideal point of $\mathcal{O}^u(x_i)$ converges to v as $i \rightarrow \infty$. Suppose for a moment that not all endpoints of $\mathcal{O}^u(x_i)$ converge to v . Then up to subsequence assume one of the endpoints converges to w distinct from v . By the escape lemma (Lemma 4.4) up to subsequence $(\mathcal{O}^u(x_i))$ converges to a leaf δ of \mathcal{O}^u which has an ideal point v . But v is also an ideal point of line leaf l of \mathcal{O}^s , contradiction to no perfect fits by Lemma 3.20. We conclude that all ideal points of $\mathcal{O}^u(x_i)$ converge to v .

In order to finish the analysis of Case 1.a it is enough to analyze the following situation, which we state as a separate case as it will be useful later on:

Case 1.b Suppose that $\mathcal{O}^u(x_i)$ escapes compact sets in \mathcal{O} , but $\mathcal{O}^s(x_i)$ does not escape compact sets in \mathcal{O} .

Up to subsequence suppose that $\mathcal{O}^s(x_i)$ converges to a line leaf l of \mathcal{O}^s . Since $\mathcal{O}^u(x_i)$ escapes compact sets it converges to an ideal point of l , which we denote by v (again this follows from Lemma 4.4). Let u be the other ideal point of l .

Let Z_i be the component of $\partial\mathcal{O} - \partial\mathcal{O}^u(x_i)$ which contains u . In this case (Z_i) converges to the set $\partial\mathcal{O} - \{v\}$. Let u_i be the ideal point of $\mathcal{O}^s(x_i)$ very close to u . Suppose first up to subsequence that $\gamma_i(Z_i)$ is not equal to Z_i for all i . Then $\gamma_i(Z_i)$ is an arbitrary small interval very close to v . This shows that $\gamma_i|(\partial\mathcal{O} - v)$ converges locally uniformly to v and so in \mathcal{R} it follows that $\gamma_i|(\mathcal{R} - \varphi(v))$ converges locally uniformly to $\varphi(v)$. So we assume from now on that $\gamma_i(Z_i) = Z_i$ for all i and hence $\gamma_i(u_i) = u_i$. As the γ_i are associated to positive direction of the flow then the ideal points of $l_i = \mathcal{O}^s(x_i)$ are attracting for the action of γ_i in $\partial\mathcal{O}$ (Lemma 4.10).

Claim 2 $\gamma_i|(\partial\mathcal{O} - v)$ converges locally uniformly to u .

We already know that $\gamma_i(Z_i) = Z_i$ for all i . As v is an ideal point of a leaf of \mathcal{O}^s and Φ has no perfect fits then v has a neighborhood basis defined by unstable leaves. So it suffices to show that for a fixed unstable leaf s intersecting l , the endpoints of $\gamma_i(s)$ converge to u . Assume for simplicity that s is nonsingular.

Notice first that it may be that the sectors of l_i are not invariant under γ_i . A priori it may seem that this cannot happen because $\gamma_i(Z_i) = Z_i$. But in fact this occurs when γ_i acts in an orientation reversing way on \mathcal{O} or equivalently on $\partial\mathcal{O}$. Then the other components of $\partial\mathcal{O} - \partial\mathcal{O}^u(x_i)$ are not γ_i invariant (there are ≥ 2 such other components as x_i is singular), and the components of $\partial\mathcal{O} - \mathcal{O}^s(x_i)$ are also not invariant.

To analyze Claim 2, notice that $\gamma_i(s)$ intersects l_i . If one endpoint of $\gamma_i(s)$ converges to u (as $i \rightarrow \infty$), then as seen above (using the escape lemma) the other endpoint of $\gamma_i(s)$ also converges to u and so $\gamma_i|(\partial\mathcal{O} - \{v\})$ converges locally uniformly to u as desired.

The remaining case is up to subsequence $\gamma_i(s)$ converges to a leaf r of \mathcal{O}^u . See Figure 18. Here u cannot be in ∂r and so r intersects l . Let τ be the segment of l between s and r and D_0 a neighborhood of it in \mathcal{O} . Let D be the image of a smooth section $c_1: D_0 \rightarrow \widetilde{M}$ of Θ restricted to D_0 . Recall the orbits α_i of $\widetilde{\Phi}$ with $\gamma_i(\alpha_i) = \alpha_i$. Let $\beta_i = \pi(\alpha_i)$, closed orbits of Φ . Then $\widetilde{W}^s(\alpha_i) \cap D$ are segments of bounded length. Let

$$p_i = \widetilde{W}^s(\alpha_i) \cap D \cap (s \times \mathbf{R}), \quad a_i = \Theta(p_i), \quad b_i = \Theta(\gamma_i(p_i)).$$

In D we have a segment r_i of bounded length from $\widetilde{\Phi}_{\mathbf{R}}(p_i)$ to a point in $\gamma_i(\widetilde{\Phi}_{\mathbf{R}}(p_i))$. This is a segment in a *stable* leaf which contracts in positive flow direction. Flow

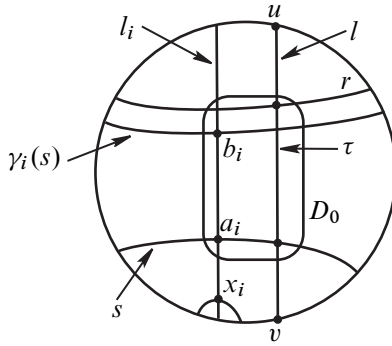

Figure 18. The case when $\gamma_i(s)$ converges to a leaf r

forward p_i by time t_i until it is distance 1 from α_i along $\widetilde{W}^s(\alpha_i)$. Notice that p_i is far from α_i for i big since x_i escapes compact sets in \mathcal{O} , hence $t_i \gg 1$. The segment r_i flows to a segment of arbitrary small length under $\widetilde{\Phi}_{t_i}$ since r_i has bounded length and t_i is very big. This is a contradiction: the endpoints of $\widetilde{\Phi}_{t_i}(r_i)$ both project in M to the same orbit in $W^s(\beta_i)$ and the same local sheet of the foliation Λ^s , but not the same local flowline of Φ . Hence these endpoints cannot be too close since the endpoint $\pi(\widetilde{\Phi}_{t_i}(p_i))$ is distance 1 from β_i in $W^s(\beta_i)$. We conclude that this cannot happen.

It follows that $\gamma_i(s)$ cannot converge to a leaf intersecting l and so as seen before, $\gamma_i(s)$ converges to u in \mathcal{D} and the endpoints of $\gamma_i(s)$ also do. This proves [Claim 2](#).

This completes the analysis of Case 1.b, and hence also of Case 1.a that is, when the $l_i = \mathcal{O}^s(x_i)$ do not escape compact sets in \mathcal{O} . The same proof applies when $\mathcal{O}^u(x_i)$ do not escape compact sets.

Case 1.c The sequences $\mathcal{O}^s(x_i), \mathcal{O}^u(x_i)$ escape compact sets in \mathcal{O} and up to subsequence all ideal points of $\mathcal{O}^s(x_i), \mathcal{O}^u(x_i)$ converge to the point v of $\partial\mathcal{O}$.

We can assume that v has a neighborhood basis defined by (say) stable leaves. Given a compact set C in $\partial\mathcal{O} - v$ let s be a nonsingular stable leaf with ideal points very close to v and separating v from C in \mathcal{D} . For i big enough all the ideal points of $\mathcal{O}^s(x_i), \mathcal{O}^u(x_i)$ are separated from C by ∂s . Then s is contained in a single interval of $\partial\mathcal{O} - (\partial\mathcal{O}^s(x_i) \cup \partial\mathcal{O}^u(x_i))$ where γ_i does not have fixed points. If γ_i leaves this interval invariant then since $\gamma_i(s)$ does not intersect s transversely, then $\gamma_i(s)$ has both ideal points closer to v than those of s and so $\gamma_i(C)$ is very close to v in \mathcal{D} . If γ_i does not leave that interval invariant then as seen above $\gamma_i(C)$ is also very close to v . As s is arbitrary this shows $\gamma_i(C) \rightarrow v$ uniformly. Therefore in \mathcal{R} it follows that $\gamma_i|(\mathcal{R} - \varphi(v))$ converges locally uniformly to $\varphi(v)$.

This finishes the analysis of Case 1: the γ_i are associated to singular orbits.

Case 2 γ_i is associated to nonsingular periodic orbits.

This is very similar to Case 1 and we can use a lot of the previous analysis. We also use the following fact, which is a uniform statement that orbits in leaves of Λ^u are backwards asymptotic:

Fact Let Φ be a pseudo-Anosov flow in M^3 . For each $a_0 > 0$ and $\epsilon > 0$ there is time $t_0 > 0$ so that if p, z are in the same leaf of $\tilde{\Lambda}^u$ and there is a path δ in $\tilde{W}^u(p)$ from p to z with length bounded above by a_0 , then there is a path from $\tilde{\Phi}_t(p)$ to $\tilde{\Phi}_R(z)$ in $\tilde{W}^u(p)$ of length less than ϵ for all $t \leq -t_0$.

Equivalently the orbits $\tilde{\Phi}_R(p), \tilde{\Phi}_R(z)$ are ϵ close to each other backwards of $\tilde{\Phi}_{-t_0}(p)$. This is proved in [26, pages 486–487]. Notice it is not at all implied that $\tilde{\Phi}_{-t_0}(p)$ and $\tilde{\Phi}_{-t_0}(z)$ are ϵ -close, which may not be true since p, z may be out of phase.

Case 2.a Suppose that both $\mathcal{O}^s(x_i)$ and $\mathcal{O}^u(x_i)$ escape compact sets in \mathcal{O} .

This is very similar to the singular situation. A proof exactly as in Case 1.c yields the result.

Case 2.b Suppose that exactly one of $\mathcal{O}^s(x_i)$ or $\mathcal{O}^u(x_i)$ escapes compact sets.

Without loss of generality assume that $\mathcal{O}^u(x_i)$ escapes compact sets and $\mathcal{O}^s(x_i)$ converges to a line leaf l of \mathcal{O}^s . Then a proof exactly as in Case 1.b yields the result.

Case 2.c Assume up to subsequence that x_i converges to x in \mathcal{O} .

If $x_i = x$ for infinitely many i then Lemma 4.10 finishes the proof. So we may assume up to subsequence that x_i are all nonsingular, distinct from each other and all in the same sectors of $\mathcal{O}^s(x)$ and $\mathcal{O}^u(x)$. This did not occur in the previous case because the set of singular points in \mathcal{O} is a discrete subset of \mathcal{O} . Let e be the boundary of this sector of $\mathcal{O}^u(x)$, a line leaf of $\mathcal{O}^u(x)$. Assume without loss of generality that up to subsequence γ_i is associated to positive flow direction in α_i . Hence $\partial\mathcal{O}^s(x_i)$ is the attracting fixed point set for γ_i and $\partial\mathcal{O}^u(x_i)$ is the repelling fixed point set for the action of γ_i on $\partial\mathcal{O}$.

We will show that $\partial\mathcal{O}^u(x), \partial\mathcal{O}^s(x)$ forms a source/sink set for the sequence γ_i acting on $\partial\mathcal{O}$. Then $a = \varphi(\partial\mathcal{O}^u(x)), b = \varphi(\partial\mathcal{O}^s(x))$ forms a source/sink pair for the sequence γ_i acting on \mathcal{R} . For simplicity assume that γ_i preserves the components of $\mathcal{O}^s(x_i) - x_i, \mathcal{O}^u(x_i) - x_i$. A similar proof works in the general case.

Let $\alpha_i = \{x_i\} \times \mathbf{R}$ and $\pi(\alpha_i)$ closed orbits of Φ . Assume all $\pi(\alpha_i)$ are distinct. Let v be a point in ∂e (which is a subset of $\partial\mathcal{O}^u(x)$). For any small neighborhood A of v in \mathcal{D} let l nonsingular stable leaf intersecting $\mathcal{O}^u(x)$ and contained in A . As $\mathcal{O}^u(x_i)$

converges to e (a line leaf in $\mathcal{O}^u(x)$) then for i big enough $\mathcal{O}^u(x_i)$ intersects l and has an ideal point v_i near v . Since v_i is a repelling fixed point for γ_i then $\gamma_i(l)$ is closer to $\mathcal{O}^s(x_i)$ than l is. Here $\mathcal{O}^s(x_i)$ is close to $\mathcal{O}^s(x)$ as well. Let $L_i = \gamma_i(l) \times \mathbf{R}$, a leaf of $\tilde{\Lambda}^s$.

The fact that is going to be used here is that the lengths of the periodic orbits $\pi(\alpha_i)$ converge to infinity, which occurs because they are all distinct orbits. Draw a disk D transverse to $\tilde{\Phi}$ containing segments r_i in $\tilde{W}^u(\alpha_i)$ from p_i in α_i to

$$z_i = (l \times \mathbf{R}) \cap \tilde{W}^u(\alpha_i) \cap D$$

and r_i transverse to $\tilde{\Phi}$ in $\tilde{W}^u(\alpha_i)$. We can assume the r_i converges to r , which is a segment in $\tilde{W}^u(p)$ (here $p = \{x\} \times \mathbf{R}$) and so the r_i have diameter uniformly bounded above. Consider $\gamma_i(r_i)$ which are segments of diameter bounded above, connecting $\gamma_i(p_i)$ to $\gamma_i(z_i)$. Notice that $\gamma_i(z_i)$ is in L_i . Choose

$$t_i \in \mathbf{R} \quad \text{with} \quad \gamma_i(p_i) = \tilde{\Phi}_{t_i}(p_i).$$

Then $t_i \rightarrow \infty$ and $p_i = \tilde{\Phi}_{-t_i}(\gamma_i(p_i))$.

By the fact above there are segments from p_i to $\tilde{\Phi}_{\mathbf{R}}(\gamma_i(z_i))$ in $\tilde{W}^u(\alpha_i)$ with diameter converging to 0 as $i \rightarrow \infty$. As the p_i are converging to the point p in $\{x\} \times \mathbf{R}$, this shows that $\gamma_i(l)$ is converging to (a line leaf of) $\mathcal{O}^s(x)$.

This shows that $\partial\mathcal{O}^u(x)$ is the repelling fixed point set for γ_i and $\partial\mathcal{O}^s(x)$ is the attracting set. This finishes the analysis of Case 2.

Case 3 All the γ_i act freely on \mathcal{O} .

This case is extremely long.

By [Lemma 4.9](#) and [Lemma 4.10](#) each γ_i acts on $\partial\mathcal{O}$ with only two distinct fixed points v_i, u_i forming a source/sink pair, that is, hyperbolic dynamics in $\partial\mathcal{O}$. Assume up to subsequence that u_i converges to u and v_i converges to v in $\partial\mathcal{O}$. It may be that u is equal to v . Ideally we would like to show that $\gamma_i|(\partial\mathcal{O} - v)$ converges locally uniformly to u . Very surprisingly this is not true in general; see the counterexample after the end of the proof.

We first consider the situation that $u = v$. This is dealt with exactly as in Case 1.c.

Hence from now on suppose that $u \neq v$. Assume without loss of generality that v is not an ideal point of a leaf of \mathcal{O}^s and hence by [Proposition 3.33](#), v has a neighborhood system defined by stable leaves. Let l be a nonsingular stable leaf with ideal points near v , separating it from u . This uses the fact that $u \neq v$. If some subsequence of $(\gamma_i(l))$ escapes compact sets in \mathcal{O} , then by the escape lemma ([Lemma 4.4](#)(iii)), the

ideal points of $\gamma_i(l)$ have to be very near each other. Then these ideal points have to be very near u_i and hence very near u . If this happens for l arbitrarily near u , then this implies the convergence property: compact sets of $\partial\mathcal{O} - \{v\}$ converge to u under γ_i . Hence by way of contradiction assume for the remainder of Case 3:

Running hypothesis for the remainder of Case 3 Up to subsequence suppose that there is l^c with ideal points very near v and separating it from u , so that $\gamma_i(l^c)$ converges to a line leaf l^d of some leaf of \mathcal{O}^s .

There are 2 possibilities.

Case 3.1 The point v is not an ideal point of a leaf of \mathcal{O}^u .

Then there is a neighborhood system of v defined by unstable leaves as well. For a stable leaf l as above let $\partial l = \{a_1, a_2\}$, where we suppress the dependence on l for notational simplicity. Consider the collection of unstable leaves $\{s \in \mathcal{O}^u \mid s \cap l \neq \emptyset\}$.

We claim that if l is close to v then so are all the possible s . Otherwise vary l and take limits of l approaching v and also take limits of such s with one ideal point not close to v , then using the escape lemma one produces an unstable leaf with ideal point v , contrary to assumption.

In the same way if $s \cap l$ is near a_1 in \mathcal{D} then s is near a_1 in \mathcal{D} and has all ideal points near a_1 . Otherwise consider a sequence $s_n \in \mathcal{O}^u$ with $s_n \cap l$ converging to a_1 . If s_n does not escape in \mathcal{O} , then the escape lemma produces an unstable leaf with ideal point a_1 , contrary to hypothesis in this case. Since s_n escapes compact sets and has $s_n \cap l$ converging to a_1 , [Lemma 4.4](#) again implies that the ideal points of s_n also converge to a_1 . Similarly if $s \cap l$ is near a_2 in \mathcal{D} then s is near a_2 in \mathcal{D} . It follows that there is a unique unstable leaf s' intersecting l so that s' has a singularity in W and has at least 2 prongs contained in W and enclosing v . Enclosing v means that if b'_1, b'_2 are the ideal points of these 2 prongs then a_1, b'_1, v, b'_2, a_2 are all distinct and circularly ordered in $\partial\mathcal{O}$ (under some circular order in $\partial\mathcal{O}$). There is then one prong of s' exiting W so that together with a prong inside W it defines a small neighborhood of v . The union of these two prongs is a slice s_1 in s' . Let $\partial s_1 = \{b_1, b_2\}$ with b_1 an ideal point of W . Let $l_1 = l$. This was the first step of the process, which is going to be done twice. We know that $\gamma_i(l_1)$ does not limit to u and we can assume up to subsequence that $\gamma_i(l_1)$ converges to l_0 a stable leaf with no limit point in u .

Now redo the process above to obtain a leaf l_2 of \mathcal{O}^s and a slice s_2 of \mathcal{O}^u which are closer to v . Let $\partial l_2 = \{c_1, c_2\}$ and $\partial s_2 = \{d_1, d_2\}$. By doing this procedure 3 or 4 times, we can arrange the construction so that for instance $a_1, b_1, c_1, d_1, v, c_2, d_2, a_2, b_2$ are all distinct and circularly ordered in $\partial\mathcal{O}$; see [Figure 19\(a\)](#).

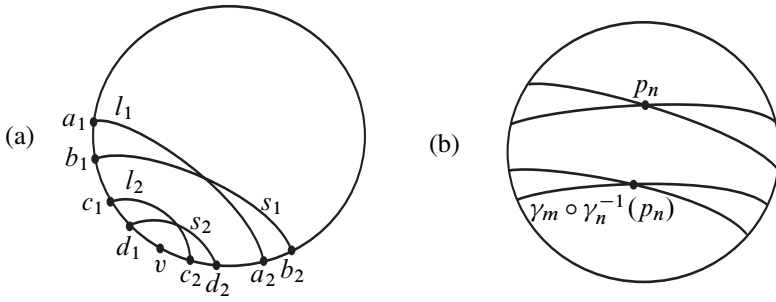

Figure 19. (a) Set up in \mathcal{O} (b) Producing fixed points

The $\gamma_i(l_2), \gamma_i(s_2)$ do not escape to u , because they are bounded by l_d . Let $j = 1, 2$. We may assume that the sequence $(\gamma_i(l_j))$ is nested and converges to l'_j and likewise $(\gamma_i(s_j))$ is nested and converges to s'_j , as $i \rightarrow \infty$ for $j = 1, 2$. Because of the set up of the ideal points as above then l'_1 has no common ideal point with l'_2 . If for instance $\lim \gamma_i(a_1) = \lim \gamma_i(c_1)$ then it is also equal to $\lim \gamma_i(b_1)$ and one produces one unstable leaf s'_1 sharing an ideal point with a stable leaf l'_1 , disallowed by no perfect fits. It follows that all four limits of ideal points are distinct. Fix n very big and let $m \gg n$. Since $\gamma_m(l_1), \gamma_n(l_1)$ are both very near l'_1 and $\gamma_m(s_1), \gamma_n(s_1)$ are very near s'_1 then

$$\gamma_m(l_1 \cap s_1) \text{ is very near } \gamma_n(l_1 \cap s_1) = p_n,$$

or $\gamma_m \circ \gamma_n^{-1}(p_n)$ is very near p_n ; see Figure 19(b). If $l'_1 \cap s'_1$ is singular assume up to subsequence that all $\gamma_i(l_1 \cap s_1)$ are in the intersection of closures of sectors of $\mathcal{O}^s(l'_1 \cap s'_1)$ and $\mathcal{O}^u(l'_1 \cap s'_1)$. With these conditions and the fact that γ_m, γ_n are distinct, then the shadow lemma for pseudo-Anosov flows [41; 44] implies that $\gamma_m \circ \gamma_n^{-1}$ has a fixed point very near p_n . Similarly there is a fixed point of $\gamma_m \circ \gamma_n^{-1}$ near $\gamma_n(l_2 \cap s_2)$. Since $l'_1 \cap s'_1, l'_2 \cap s'_2$ are different, then for n, m sufficiently big these two fixed points are different. But then $\gamma_m \circ \gamma_n^{-1}$ would have two distinct fixed points in \mathcal{O} , which is disallowed by the no perfect fits condition. This cannot happen. Therefore $\gamma_i(l)$ converges to u for any l close enough to v and this finishes the analysis of Case 3.1.

Case 3.2 Suppose that v is an ideal point of a leaf s of \mathcal{O}^u .

The proof of this case is very long. In this case we do not necessarily obtain that $\gamma_i|(\partial\mathcal{O} - v)$ converges locally uniformly to u . Suppose l is nonsingular, intersects s and $W \cap s$ has no singular points. As in Case 3.1 we only have to deal with the case that $\gamma_i(l)$ does not escape compact sets in \mathcal{O} .

From now on in this case fix this leaf l of \mathcal{O}^s .

Assume that $\gamma_i(l)$ converges to a line leaf l^* of a leaf l_0 of \mathcal{O}^s . Let l' be any stable leaf intersecting s and closer to v than l is.

The first situation is that up to subsequence $\gamma_i(l')$ converges to l'_0 different from l_0 . Then l_0, l'_0 do not share an ideal point, because of the no perfect fits hypothesis. Since $\gamma_i(s)$ intersects $\gamma_i(l), \gamma_i(l')$ and $\gamma_i(l), \gamma_i(l')$ converge to l_0, l'_0 not sharing an ideal point then $\gamma_i(s)$ cannot escape in \mathcal{O} . This follows directly from the escape lemma.

Hence assume $\gamma_i(s)$ converges to a leaf s_1 of \mathcal{O}^u . Notice that s_1 intersects l_0 and l'_0 for otherwise, by the escape lemma again, s_1 will share ideal point with at least one of l_0, l'_0 , again disallowed by the no perfect fits condition. Therefore $\gamma_i(l \cap s)$ converges to $l_0 \cap s_1$ and $\gamma_i(l' \cap s)$ converges to $l'_0 \cap s_1$. As seen before, if n, m are big enough this produces 2 distinct fixed points of $\gamma_m \circ \gamma_n^{-1}$ – one near $l_0 \cap s_1$ and one near $l'_0 \cap s_1$. This is disallowed.

We conclude that for any l' stable leaf intersecting s and separating v from l , the sequence $\gamma_i(l')$ also converges to l^* . Let

$$w, w' \text{ be the ideal points of } l^*.$$

Let z, z' be the ideal points of l . Let I, I' be the disjoint half open intervals of $\partial\mathcal{O}$ with one ideal point in z, z' and the other in v , that is, $z \in I$ but v is not in I (for some orientation of \mathcal{O} then $I = [z, v), I' = (v, z']$). Assume without loss of generality that $\gamma_i(z)$ converges to w . The arguments above show that $\gamma_i(I)$ converges locally uniformly to w and $\gamma_i(I')$ converges locally uniformly to w' .

The strategy to prove Case 3.2 is as follows: Using the no perfect fits condition we will incrementally upgrade the property above to show that $\gamma_i|(\partial\mathcal{O} - \partial s)$ converges locally uniformly to ∂l^* – this last one is a set, not a single point. This means that for any C compact contained in $\partial\mathcal{O} - \partial s$, then for i big enough $\gamma_i(C)$ is contained in a small neighborhood of ∂l^* . Notice that s may be singular so the set $\partial\mathcal{O} - \partial s$ may have more than 2 components.

Recall that in Case 3.2 the leaf l of \mathcal{O}^s is fixed. Consider an arbitrary unstable leaf s' intersecting l , with $s' \neq s$. Then s' has at least one ideal point in either I or I' . If s' has an ideal point t in I then $\gamma_i(t)$ converges to w . Since no unstable leaf has ideal point w it follows from the escape lemma that $\gamma_i(s')$ converges to w in \mathcal{D} . Let now $J (J')$ be the component of $(\partial\mathcal{O} - \partial s)$ containing $z (z')$ (hence $I \subset J, I' \subset J'$). The above arguments imply that $\gamma_i(J)$ converges locally uniformly to w and $\gamma_i(J')$ converges locally uniformly to w' . To prove this use the fact that for any $c \in J - \bar{I}$ there is s' unstable leaf with $s' \cap l \neq \emptyset$ and $\partial s'$ separating ∂s from c in $\partial\mathcal{O}$. This last statement follows from the escape lemma and the fact that there are no leaves in \mathcal{O}^u nonseparated from s .

If s is nonsingular we are done. This is because if v, t are the ideal points of s , then $\varphi(v) = \varphi(t) = y$ and $\varphi^{-1}(y) = \{v, t\}$. For any compact set C in $\mathcal{R} - y$ there is a

compact set V in $\partial\mathcal{O} - \{v, t\}$ with $C \subset \varphi(V)$, since $\varphi^{-1}(y) = \{v, t\}$. Hence V is contained in the union of 2 compact intervals V_1, V_2 in $\partial\mathcal{O} - \{v, t\}$ so up to reordering $V_1 \subset J$ and $V_2 \subset J'$. Hence

$$\gamma_i|_{V_1} \text{ converges to } w \quad \text{and} \quad \gamma_i|_{V_2} \text{ converges to } w'.$$

Notice $\varphi(w) = \varphi(w')$ and let this be x . This shows that in \mathcal{R} , $\gamma_i|_C$ converges uniformly to x . Hence y, x is the source/sink pair for γ_i . With more analysis one can show that u is not an ideal point of s and u is an ideal point of l_0 . We do not provide the arguments as we will not use that.

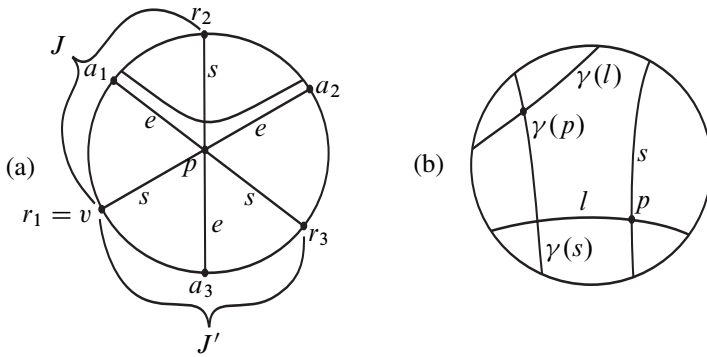

Figure 20. (a) Trapping the orbits in the singular case ($n = 3$) (b) An interesting counterexample

To finish the analysis of Case 3.2, we suppose from now on that s is singular with n prongs. Let $r_1 = v$, let r_2 be the other endpoint of J – this is also an ideal point of s and let r_n be the similar endpoint of J' . Complete the ideal points of s circularly to r_1, \dots, r_n . Let p be the singular point in s ; see Figure 20(a). Let e be the stable leaf through p . Then e has a prong with ideal point a_1 in J and one with ideal point a_n in J' . Order the other endpoints of e as a_1, \dots, a_n . Let e^* be the line leaf of e with ideal points a_1, a_n . We proved above that $\gamma_i(a_1)$ converges to w and $\gamma_i(a_n)$ converges to w' . There are two options: (1) $\gamma_i(p)$ does not escape compact sets in \mathcal{O} ; (2) $\gamma_i(p)$ escapes compact sets in \mathcal{O} .

Option 1 Suppose that $\gamma_i(p)$ does not escape compact sets in \mathcal{O} .

Up to subsequence $\gamma_i(p)$ converges in \mathcal{O} so assume that $\gamma_i(p) = p_0$ for $i \geq i_0$ (using the fact that p is singular). Let f be the generator of the isotropy group of p_0 fixing also $\gamma_{i_0}(a_1) = w$, $\gamma_{i_0}(a_n) = w'$ and f associated to the forward direction in the orbit $\{p_0\} \times \mathbf{R}$. Since $\gamma_i(a_1), \gamma_i(a_n)$ converge to w, w' , there is i_0 so that for $i > i_0$,

$$\gamma_i = f^{m_i} \circ \gamma_{i_0}, \quad m_i \in \mathbf{Z}.$$

Here w is an attracting point, so m_i converges to $+\infty$. Lemma 4.10 now implies that for any compact set C in $\partial\mathcal{O} - \partial s$ then $\gamma_i(C)$ is in a small neighborhood of $\partial\mathcal{O}^s(p_0)$. All points of ∂s are identified under φ and similarly for $\partial\mathcal{O}^s(p_0)$. Let $y = \varphi(\partial s)$, $x = \varphi(\partial\mathcal{O}^s(p_0))$. Then in \mathcal{R} , $\gamma_i|(\mathcal{R} - y)$ converges locally uniformly to x . This finishes the argument for Option 1.

Option 2 Suppose that $\gamma_i(p)$ escapes compact sets in \mathcal{O} .

Since $\gamma_i(e^*)$ converges to l^* and $\gamma_i(p)$ is in $\gamma_i(e^*)$, the escape lemma implies that $\gamma_i(p)$ converges to either w or w' . Suppose without loss of generality that $\gamma_i(p)$ converges to w . Then $\gamma_i(a_n)$ converges to w' and all the ideal points a_1, \dots, a_{n-1} converge to w under γ_i . Here is the justification of this statement: If for some j in $2, \dots, n-1$, $\gamma_i(a_j) \rightarrow w'$, then also $\gamma_i(a_{n-1}) \rightarrow w'$. Hence $\gamma_i(r_n) \rightarrow w'$. But since $\gamma_i(p) \rightarrow w$, then that unstable prong of $\mathcal{O}^u(p)$ converges to an unstable leaf with one ideal point in w and another in w' . This is disallowed under no perfect fits (in fact this cannot happen in general, but we will not need that). Therefore $\gamma_i(a_n) \rightarrow w'$ and $\gamma_i(a_j) \rightarrow w$ for $j = 1, \dots, n-1$.

Let J_2 be the interval of $\partial\mathcal{O}$ bounded by $v (= r_1)$ and r_n and so that J_2 is disjoint from J' , that is, $J_2 = \partial\mathcal{O} - \overline{J'}$. If A is the region of J_2 between a_{n-1} and r_n we claim that $\gamma_i(J_2 - A)$ converges to w . Here $(\gamma_i(a_j))$ converges to w , $1 \leq j \leq n-1$. The nonsingular unstable leaves s' intersecting $\mathcal{O}^s(p)$ in the prong with ideal point a_{n-1} have one ideal point in A and another ideal point y in $J_2 - A$. Since $\gamma_i(a_{n-1}) \rightarrow w$, then $\gamma_i(y) \rightarrow w$. This implies that the ideal points of s' both have to converge to w under γ_i . Since γ_i is a homeomorphism of $\partial\mathcal{O}$ it now follows that $\gamma_n(J_2)$ converges locally uniformly to w . As $\gamma_i(J')$ converges locally uniformly to w' then

$$\gamma_i | (\partial\mathcal{O} - \partial s) \text{ converges locally uniformly to } \{w, w'\}.$$

Notice that $\partial\mathcal{O}$ is the disjoint union of J_2, J', r_1, r_n . If $y = \varphi(\partial s)$ and $x = \varphi(w)$ then y, x is the source/sink pair for a subsequence γ_i acting on \mathcal{R} . This finishes Case 3.2.

This shows that $\pi_1(M)$ acts as a convergence group on \mathcal{R} and finishes the proof of Theorem 4.11. □

Remark We construct an example as in Case 3.2 where the sequence $(\gamma_i)_{i \in \mathbb{N}}$ does not have source/sink pair the points v, u for the action on $\partial\mathcal{O}$ as naively expected in Case 3.2. In fact the source is a collection of points and so is the sink. We start with Φ a pseudo-Anosov flow without perfect fits, not conjugate to suspension Anosov. For simplicity assume that everything is orientable. In addition assume that Φ is transitive. The tricky thing is to get γ_i to act freely on \mathcal{O} . Let $s = \mathcal{O}^u(p), l = \mathcal{O}^s(p)$ where p is periodic, nonsingular. Let γ in $\pi_1(M)$ with $\gamma(s)$ intersecting l and so that $\gamma(l)$

does not intersect s ; see [Figure 20\(b\)](#). Since Φ is transitive it is always possible to find such γ unless there is a product region in that quarter of p , but then Φ would be conjugate to a suspension Anosov flow, contrary to assumption. Let f be the generator of the isotropy group of $\gamma(p)$ leaving invariant all points in $\partial\mathcal{O}^s(\gamma(p))$, $\partial\mathcal{O}^u(\gamma(p))$ and associated to the positive direction of the flow line. Let $\gamma_i = f^i \circ \gamma$. Then $\{\gamma_i\}_{i \in \mathbb{N}}$ are all distinct.

Suppose that for some j , the γ_j has a fixed point. Fix j and let $h = \gamma_j$. Notice that $l, h(l)$ ($= \gamma(l)$) both intersect a common unstable leaf $\gamma(s)$; also $s, h(s)$ ($= \gamma(s)$) intersect the stable leaf l and $s, h(l)$ do not intersect. If $h^m(l)$ converges to r as $m \rightarrow \infty$ then $h(r) = r$. This is because the leaf space \mathcal{H}^s of $\tilde{\Lambda}^s$ is Hausdorff. Hence h has a fixed point q in r . Then $h(\mathcal{O}^u(q)) = \mathcal{O}^u(q)$ and $\mathcal{O}^u(q)$ intersects $h^m(l)$ for m big enough and hence for all m . But since h contracts $h^m(l)$ towards $\mathcal{O}^s(q)$ then it expands unstable leaves away. In particular s cannot intersect r . However by construction h moves s and l in the same direction and hence $\gamma_j(s)$ is closer to $\mathcal{O}^u(q)$ than s is. It follows that $h^m(s)$ converges to a leaf t and t does not intersect r . Hence $h(r) = r$, $h(t) = t$ and $r \cap t = \emptyset$. This produces two fixed points of h in \mathcal{O} . Hence [Theorem 2.5](#) implies that there are perfect fits, contrary to assumption. This contradiction shows that h does not have any fixed point in the component of $\mathcal{O} - l$ containing $h(l)$. Now consider h^{-1} : $h^{-1}(l) = \gamma^{-1}(l)$ does not intersect l and $h^{-1}(s) = \gamma^{-1}(s)$ intersects l . So the same argument as above shows that h does not have a fixed point in the component of $\mathcal{O} - l$ containing $h^{-1}(l)$. Hence h does not have fixed points in \mathcal{O} and acts freely.

It follows that each γ_i acts freely on \mathcal{O} and has 2 fixed points v_i, u_i in $\partial\mathcal{O}$. In addition as $i \rightarrow \infty$, u_i converges to an ideal point of $\gamma(l)$ and v_i converges to an ideal point of s – the one separated from $\gamma(l)$ by l . So this is exactly the situation in [Case 3.2 of Theorem 4.11](#). Notice also that $\gamma_i(s) = \gamma(s)$ and $\gamma_i(l) = \gamma(l)$ so the collection $\{\gamma_i\}_{i \in \mathbb{N}}$ does not act properly discontinuously on \mathcal{O} . Here $\gamma_i(\partial s) = \gamma(\partial s)$ and $\gamma_i(\partial l) = \partial\gamma(l)$, so there are not two points in $\partial\mathcal{O}$ forming a source/sink pair for the action of (γ_i) on $\partial\mathcal{O}$. Still $\gamma_i|(\partial\mathcal{O} - \partial s)$ converges locally uniformly to $\partial\gamma(l)$.

The next goal is to show that every point in \mathcal{R} is a conical limit point.

Theorem 4.12 *Let Φ a pseudo-Anosov flow without perfect fits, not conjugate to a suspension Anosov flow. Let \mathcal{R} be the associated sphere quotient of $\partial\mathcal{O}$. Then every point in \mathcal{R} is a conical limit point for the action of $\pi_1(M)$ on \mathcal{R} . Hence $\pi_1(M)$ acts as a uniform convergence group on \mathcal{R} .*

Proof The last statement follows from the first because [Theorem 4.7](#) implies that the action of $\pi_1(M)$ on the space of distinct triples of \mathcal{R} is cocompact.

We show that any x in \mathcal{R} is a conical limit point for the action of $\pi_1(M)$. There are 3 cases:

Case 1 $x = \varphi(z)$ where z is the ideal point of l of \mathcal{O}^s or \mathcal{O}^u and there is $\gamma \neq \text{id}$ in $\pi_1(M)$ with $\gamma(l) = l$.

Since all ideal points of l are taken to x under φ and γ permutes the ideal points of l , it follows that $\gamma(x) = x$. Assume that x is the repelling fixed point of γ , up to taking an inverse if necessary. Let $\gamma_i = \gamma^i, i \geq 0$. Then $\gamma_i(x) = x$ so $\gamma_i(x)$ converges to x . Let c be the other fixed point of γ in \mathcal{R} . For any y distinct from x in \mathcal{R} it follows from Lemma 4.10, that $\gamma_i(y) = (\gamma^i)(y)$ converges to c . Hence x is a conical limit point.

Case 2 $x = \varphi(z)$ where z is an ideal point of l of \mathcal{O}^s or \mathcal{O}^u and l is not invariant under any γ of $\pi_1(M)$.

Suppose without loss of generality that l is an unstable leaf. Let $L = l \times \mathbf{R}$ a leaf of $\tilde{\Lambda}^u$. Here $\pi(L)$ does not have a periodic orbit of Φ . Let α be an orbit of $\tilde{\Phi}$ in L . We look at the asymptotic behavior of $\pi(\alpha)$ in the negative direction (all orbits in L are backward asymptotic, so this argument is independent of the orbit α in L). If $\pi(\alpha)$ limits only in a singular orbit then $\pi(\alpha)$ must be in the unstable leaf of a singular orbit, contrary to assumption.

For each i choose p_i in α with (p_i) escaping in the negative direction and $(\pi(p_i))$ converging to a nonsingular point μ in M . By discarding a number of initial terms, we can assume that all $\pi(p_i)$ are in a neighborhood V of μ to which the shadow lemma can be applied. There are γ_i in $\pi_1(M)$ with $\gamma_i(p_i)$ in V . By the shadow lemma the γ_i correspond to closed orbits β_i of the flow Φ . In particular we assume that V is sufficiently small, so that there is still a small neighborhood U of μ with $\bar{V} \subset U$ and there are lifts $\tilde{\beta}_i$ of β_i with points in U . We assume that \bar{U} does not intersect any singular orbit. It follows that no β_i is a singular orbit. Since $\tilde{\beta}_i, \gamma_i(\alpha)$ have points near p_1 , we may also assume up to subsequence that both sequences converge. Let τ be the limit of $(\tilde{\beta}_i)$. Hence τ is also not a singular orbit. Notice that a priori there is no relation between μ and τ except that μ is near τ . Let also δ be the limit of $(\gamma_i(\alpha))$. Notice that $\pi(\delta)$ has a point in \bar{V} .

Each γ_i takes p_i to a point very close to p_1 and the p_i escape in \tilde{M} with i , so up to subsequence we can assume that the γ_i are all distinct. Hence the length of β_i goes to infinity (the β_i does not have to be an indivisible closed orbit). Let $q_i = \Theta(\tilde{\beta}_i)$, so (q_i) converges to $q_0 = \Theta(\tau)$. Let

$$\partial\mathcal{O}^u(q_0) = \{s, s'\}, \quad \partial\mathcal{O}^s(q_0) = \{t, t'\}, \quad \partial\mathcal{O}^u(q_i) = \{s_i, s'_i\}, \quad \partial\mathcal{O}^s(q_i) = \{t_i, t'_i\}.$$

Since the points p_i are flow backwards of p_1 in α and p_i is sent near p_1 by γ_i , then γ_i corresponds to the flow lines β_i being traversed in the forward direction. By Lemma 4.10, $\{s_i, s'_i\}$ is the repelling set for the action of γ_i on $\partial\mathcal{O}$ and $\{t_i, t'_i\}$ is the attracting set.

Here $\mathcal{O}^s(q_i)$ intersects $l = \mathcal{O}^u(\alpha)$ and $\mathcal{O}^u(\gamma_i(\alpha))$ for every i . As described above $\gamma_i(l)$ converges to the unstable leaf $r := \mathcal{O}^u(\Theta(\delta))$. Since $\mathcal{O}^u(\gamma_i(\alpha))$ converges and the length of β_i goes to infinity, then the arguments of Case 2.c of the proof of Theorem 4.11 show that the only possibility is that $\mathcal{O}^u(q_i)$ converges to $l = \mathcal{O}^u(\alpha)$, otherwise l would be pushed farther and farther away from $\mathcal{O}^u(q_i)$. This shows that τ is in L and s, s' are the ideal points of l . Up to renaming the ideal points of l , $z = s$. Up to another subsequence assume that

$$s_i \rightarrow s, \quad s'_i \rightarrow s', \quad t_i \rightarrow t, \quad t'_i \rightarrow t'.$$

Again the arguments in Case 2.c of Theorem 4.11 show that $\gamma_i|(\partial\mathcal{O} - \{s, s'\})$ converges locally uniformly to the set $\{t, t'\}$ in $\partial\mathcal{O}$. Also $\gamma_i(z)$ converges to a point d in ∂r . As $z = s$ then $x = \varphi(s)$ and we have in \mathcal{R} that $\gamma_i|(\mathcal{R} - \{x\})$ converges locally uniformly to $\varphi(t)$. Since d is a unstable ideal point and t is a stable ideal point, it follows that $\varphi(t) \neq \varphi(d)$. Summing it all up:

$$\gamma_i(x) \rightarrow \varphi(d) \quad \text{and} \quad \gamma_i(y) \rightarrow \varphi(t) \quad \text{for any } y \in \mathcal{R} - \{x\}.$$

This shows that x is a conical limit point.

Remark Obviously it is crucial in this proof that z is an ideal point of a leaf of \mathcal{O}^s or \mathcal{O}^u . Since z is an unstable ideal point and we want to push points away from the unstable ideal point, then in the proof above we use γ_i associated to positive flow direction (recall Lemma 4.10), while keeping track of what γ_i does to z . The only difference is that here we were careful to make sure $\gamma_i(z)$ did not converge to a certain stable ideal point in the limit. This proof does not work at all in the case z is not ideal point of a leaf of \mathcal{O}^s or \mathcal{O}^u .

Case 3 $x = \varphi(z)$ where z is not ideal point of a leaf of \mathcal{O}^s or \mathcal{O}^u .

This case is much more interesting. Since z is not ideal point of a leaf of \mathcal{O}^s or \mathcal{O}^u , by Proposition 3.33 there is a neighborhood system of z in \mathcal{D} defined by a sequence of stable leaves, which can be assumed to be all nonsingular. Let l_1 be one of these leaves. The construction here will be inductive. Let W be the component of $\mathcal{O} - l_1$ which has z in its closure. Let $\partial l_1 = \{b_0, b_1\}$. Let (b_0, z) be the interval of $\partial\mathcal{O}$ contained in the closure of W in \mathcal{D} and similarly define (b_1, z) . Let s be a leaf of \mathcal{O}^u intersecting l_1 . If s is near b_0 then all ideal points of s are near b_0 , by the

escape lemma (Lemma 4.4(iii)). If s is near b_1 then all ideal points are near b_1 . The ideal points of the prongs of s entering W vary monotonically in $\partial\mathcal{O}$ as one moves s across l_1 . Since no unstable leaf has ideal point z and the leaf space of \mathcal{O}^u is Hausdorff, then there is a single leaf – call it s_1 intersecting l_1 and having at least one prong contained in W with an ideal point in (b_0, z) and another prong with ideal point in (b_1, z) ; see Figure 21(a). Let p_1 be the singular point in this leaf which has to be in W . Let v_1 be the ideal point of $\mathcal{O}^u(p_1)$ in (b_0, z) closest to z and u_1 the one in (b_1, z) closest to z . Let a_1 be the ideal point of the (unique) prong of $\mathcal{O}^u(p_1)$ intersecting l_1 .

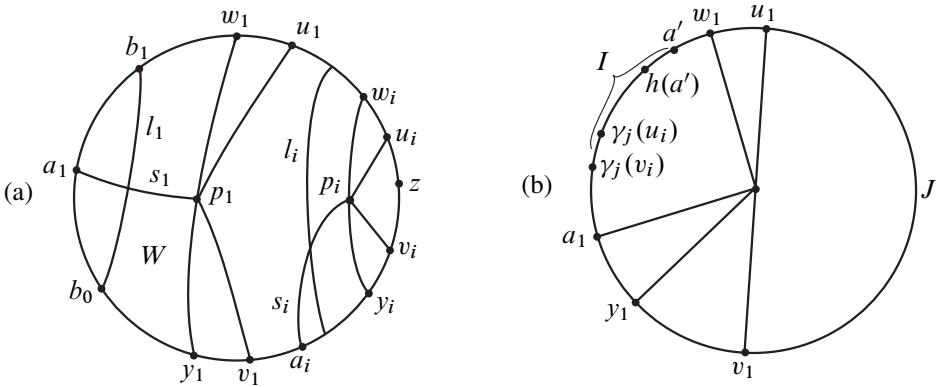

Figure 21. (a) Splitting in the stable leaves (b) Mapping back to a compact region

We can now proceed inductively: assuming that l_{i-1} has been chosen and s_{i-1}, p_{i-1} have been constructed, let l_i be a stable leaf separating z from $\mathcal{O}^u(p_{i-1})$. As before construct s_i, p_i, u_i, v_i ; see Figure 21(a). Let w_i be the ideal point of $\mathcal{O}^s(p_i)$ in (u_i, b_1) closest to b_1 and y_i the ideal point of $\mathcal{O}^s(p_i)$ in (v_i, b_0) closest to b_0 – do this also for $i = 1$. There are such points because $\mathcal{O}^u(p_i)$ intersects l_i which is a stable leaf. Let a_i be the ideal point of the prong of $\mathcal{O}^u(p_i)$ which intersects l_i .

We will now take subsequences at will and rename points and transformations, in order to simplify notation. Every p_i is singular, so up to subsequence assume the p_i are all translates of each other. Hence there are γ_i in $\pi_1(M)$ with $\gamma_i(p_i) = p_1$. Up to another subsequence either every γ_i preserves orientation in \mathcal{O} , or every γ_i reverses orientation in \mathcal{O} . In the second case throw out p_1 (that is start with p_2 which will be renamed p_1 and also rename the γ_i to have $\gamma_i(p_i) = p_1$ for the new p_1 , etc...). So we can assume that every γ_i preserves orientation in \mathcal{O} . Up to a further subsequence assume that $\gamma_i(a_i) = a_1$ (where as before throw out initial terms and rename if necessary). Under these conditions, it now follows that $\gamma_i(u_i) = u_1, \gamma_i(v_i) = v_1, \gamma_i(w_i) = w_1, \gamma_i(y_i) = y_1$. Let (a_i, w_i) be the interval in $\partial\mathcal{O}$ defined by a_i, w_i and not containing z .

Assume also up to subsequence that for $j > i$ then y_i, v_i, u_i, w_i are in (a_j, w_j) ; see Figure 21(a). This is because there are 2 possibilities for the placement of a_j .

Since p_1 is singular, let h be a generator of the isotropy group of p_1 which leaves all prongs of $\mathcal{O}^s(p_1)$ (and hence of $\mathcal{O}^u(p_1)$) invariant. Ideally we would like to obtain transformations which send more and more of $\partial\mathcal{O} - \{z\}$ to a compact set in (a_1, w_1) . However in order to simplify the argument and the notation with indices we will prove that this is true for a *fixed* compact set of $\mathcal{O} - \{z\}$ and then use that and the convergence group property to show that $\varphi(z)$ is a conical limit point. For each i let T_i be the closed interval of $\partial\mathcal{O}$ defined by u_i, v_i and not containing z .

For the remainder of the proof we fix i very big and let $C = T_i$ – this is almost all of $\partial\mathcal{O} - \{z\}$. Let a' be a point in (a_1, w_1) . By construction for any j then $\gamma_j(u_j) = u_1$, $\gamma_j(a_j) = a_1$. Let $j > i$. Since u_i is in (a_j, w_j) then $\gamma_j(u_i)$ is in (a_1, w_1) . Now for each $j > i$ there is a single n_j in \mathbf{Z} so that

$$h^{n_j}(\gamma_j(u_i)) \text{ is in } [a', h(a')],$$

where $[a', h(a')]$ is the subinterval of $[a_1, w_1]$ bounded by these points. Suppose that w_1 is a repelling fixed point of h (that is, h is associated to backwards flow direction). Since γ_j preserves orientation in \mathcal{D} then $t_j = h^{n_j}(\gamma_j(v_i))$ is closer to a_1 in $[a_1, w_1]$ than $h^{n_j}(\gamma_j(u_i))$ is. We claim that t_j is in a compact set I of (a_1, w_1) as j varies (in particular $\gamma_j(C) \subset I$). See Figure 21(b). Otherwise there are j with t_j arbitrarily close to a_1 . Here

$$h^{n_j} \gamma_j(\mathcal{O}^u(p_i))$$

is an unstable leaf with a point in $[a', h(a')]$ and another very close to a_1 . Take a subsequence and find in the limit an unstable leaf δ with an ideal point in $[a', h(a')]$ and another in a_1 – a consequence of the escape lemma (Lemma 4.4(iii)). Since δ is not $\mathcal{O}^u(p_1)$ this would force the existence of perfect fits, contradiction. Hence there is a compact subinterval I in (a_1, w_1) with t_j always in I . We now define the transformations

$$g_j = h^{n_j} \gamma_j, \quad j > i, \quad \text{hence } g_j(C) \subset I.$$

Let J be the closed interval of $\partial\mathcal{O}$ bounded by u_1, v_1 and not containing a_1 . Then $g_j(z)$ is in J for any $j \geq 2$ so up to a subsequence we may assume that $g_j(z)$ converges to a point c in J .

We will show that there is a subsequence of (g_j) which proves that x is a conical limit point.

We first claim that $\varphi(I), \varphi(J)$ are disjoint. Suppose that $\varphi(I)$ intersects $\varphi(J)$. Then there has to be a leaf of \mathcal{O}^s or \mathcal{O}^u with ideal points in both I and J . Consider first the

unstable case. The endpoints of J are ideal points of $\mathcal{O}^u(p_1)$. The other ideal points of $\mathcal{O}^u(p_1)$ are not in I by construction of the interval I in (a_1, w_1) . Any other leaf of \mathcal{O}^u either has all ideal points in J or has no ideal point in J . Hence no unstable leaf has ideal points in I and J .

Consider now stable leaves: $\mathcal{O}^s(p_1)$ has one ideal point in J and all others in the interval of $\partial\mathcal{O}$ defined by w_1, y_1 and not containing I . Hence $\mathcal{O}^s(p_1)$ it does not have an ideal point in I . Let r be any other leaf of \mathcal{O}^s . If r has an ideal point in J then r is separated from the interval I by $\mathcal{O}^s(p_1)$, hence r cannot limit in I . We conclude that $\varphi(I), \varphi(J)$ are 2 disjoint compact subsets of \mathcal{R} .

Recall that $(g_n(z))$ converges to c and $x = \varphi(z)$. Hence in \mathcal{R} the sequence $(g_n(x))$ converges to $\varphi(c) \in \varphi(J)$. In [Theorem 4.11](#) we have already shown that $\pi_1(M)$ acts as a convergence group on \mathcal{R} , so assume up to subsequence that (g_n) has a source/sink pair (for notational simplicity we still denote this subsequence by (g_n)). That means there are $a, b \in \mathcal{R}$ so that $g_n(A)$ converges to b for any compact set A of $\mathcal{R} - \{a\}$. In particular if we find three distinct points d_1, d_2, d_3 of \mathcal{R} so that $g_n(d_1), g_n(d_2)$ converge to e_1 and $g_n(d_3)$ converges to e_2 with $e_1 \neq e_2$, then d_3 is the source and e_1 is the sink.

The image $\varphi(C)$ contains infinitely many points, so take 3 distinct points d_0, d_1, d_2 in $\varphi(C)$. By the above, for at least two of these points the sequence $(g_n(d_k))$ converges. So assume without loss of generality that $(g_n(d_1)), (g_n(d_2))$ converge – the limit is in $\varphi(I)$. The sequence $(g_n(x))$ also converges and the limit is in $\varphi(J)$. As $\varphi(I), \varphi(J)$ are disjoint, it follows that the limits of $(g_n(d_1)), (g_n(d_2))$ have to be the same point t . By the previous paragraph t is the sink and x is the source for the sequence (g_n) acting on \mathcal{R} . Since $t \in \varphi(I), x \in \varphi(J)$ it follows that $t \neq x$. Hence the sequence (g_n) of $\pi_1(M)$ shows that x is a conical limit point.

This shows that all points of \mathcal{R} are conical limit points for the action of $\pi_1(M)$. Hence $\pi_1(M)$ acts as a uniform convergence group in \mathcal{R} . This finishes the proof of [Theorem 4.12](#). □

We now analyze the space $\widetilde{M} \cup \mathcal{R}$. We first establish some notation. Let

$$\eta: \mathcal{D} \times [-1, 1] \rightarrow \widetilde{M} \cup \mathcal{R}$$

be the projection map. Recall also the sphere filling map $\varphi: \partial\mathcal{O} \rightarrow \mathcal{R}$. We consider the quotient topology in $\widetilde{M} \cup \mathcal{R}$. Let \mathcal{T} be this topology. Recall that $\partial(\mathcal{D} \times [-1, 1])$ is a sphere, let $\eta_1 = \eta|_{\partial(\mathcal{D} \times [-1, 1])}$. With the subspace topology from \mathcal{T} , then \mathcal{R} is a sphere also. We stress that in all arguments here we implicitly identify \widetilde{M} with $\mathcal{O} \times (-1, 1)$ and in particular also think of \widetilde{M} as a subset of $\mathcal{D} \times [-1, 1]$.

Notice that $\pi_1(M)$ naturally acts on $\tilde{M} \cup \mathcal{R}$ by homeomorphisms as it preserves stable and unstable foliations. Our main goal to finish this section is to show that this action is a convergence group action.

One problem is that it is hard to verify directly whether a set in $\tilde{M} \cup \mathcal{R}$ is open or not. To make it more explicit we define another topology \mathcal{T}' in $\tilde{M} \cup \mathcal{R}$ and then show it is the same as the quotient topology. The new topology will be defined using neighborhood systems. Recall [43, Chapter 1] that a neighborhood system \mathcal{U}_x of a point x is a collection satisfying

- (1) if U is in \mathcal{U}_x then x is in U ;
- (2) if U, V are in \mathcal{U}_x then $U \cap V$ is in \mathcal{U}_x ;
- (3) if U in \mathcal{U}_x and $U \subset V$ then V is in \mathcal{U}_x .

Define U to be open if U is a neighborhood of any of its points. This defines a topology in the space.

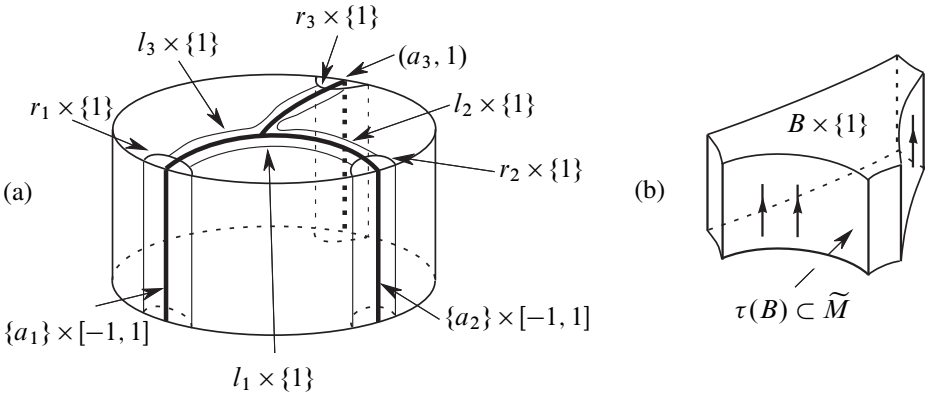

Figure 22. (a) The neighborhoods of certain points (b) Flow forward of sections

Definition 4.13 (Neighborhood systems in $\tilde{M} \cup \mathcal{R}$) Let Φ be a pseudo-Anosov flow without perfect fits, not topologically conjugate to suspension Anosov.

- (i) If x is in \tilde{M} then V is in \mathcal{U}_x if V contains an open set of \tilde{M} (with its usual topology) containing x .
- (ii) Let x in \mathcal{R} so that $\varphi^{-1}(x) = \{b\}$, a single point. The point b of $\partial\mathcal{O}$ is not identified to any other point of $\partial\mathcal{O}$, hence b is not an ideal point of a leaf of \mathcal{O}^s or \mathcal{O}^u . In this case b has a neighborhood system in \mathcal{D} defined by sequences of nonsingular stable or unstable leaves. Let l be one such leaf and U_l the corresponding open set of \mathcal{D} , as in Definition 3.18, where b is in U_l . Let $V_l = U_l \times [-1, 1]$ a subset of

$\mathcal{D} \times [-1, 1]$. We say that V is in \mathcal{U}_x if for some l as above then $V_l \subset \eta^{-1}(V)$. Notice $\eta^{-1}(V)$ is a subset of $\mathcal{D} \times [-1, 1]$.

(iii) Let x in \mathcal{R} with $\varphi^{-1}(x) = \{a_1, \dots, a_n\}$. For simplicity assume that a_1, \dots, a_n are the ideal points of a stable leaf l . Let g be the cellular decomposition element of \mathcal{R} of $\partial(\mathcal{D} \times [-1, 1])$ associated to l (that is $g = l \times \{1\} \cup \bigcup_i (\{a_i\} \times [-1, 1])$) or equivalently g is identified to the point x). For each i , choose r_i unstable leaves defining small neighborhoods of a_i in \mathcal{D} . Let $V_{r_i} = U_{r_i} \times [-1, 1]$ as in (ii), where a_i is in U_{r_i} . See Figure 22(a).

Let l_1, \dots, l_n stable leaves (\mathcal{O}^s) very near each line leaf of l and so that for each i , then l_i, l_{i+1} intersect r_i transversely ($i \bmod i_0$). Then $l_1, \dots, l_n, r_1, \dots, r_n$ bound a compact region B in \mathcal{O} . Choose any section $\tau: B \rightarrow \tilde{M}$ of Θ restricted to B . Let H_τ be the union of $B \times \{1\}$ together with the set of points w in \tilde{M} (or in $\mathcal{O} \times (-1, 1)$) with $w = \tilde{\Phi}_t(b)$ for some b in $\tau(B)$ and $t \geq 0$. See Figure 22(b). Let δ denote the collection $(l_1, \dots, l_n, r_1, \dots, r_n, \tau)$. We use the notation A_δ to denote the following:

$$A = A_\delta = A(l_1, \dots, l_n, r_1, \dots, r_n, \tau) = H_\tau \cup V_{r_1} \cup \dots \cup V_{r_n}$$

Let \mathcal{U}_x be the collection of the sets Z so that for some δ as above then $A_\delta \subset \eta^{-1}(Z)$.

In the case of ideal points of unstable leaves, one switches stable and unstable objects and chooses points flow backwards from a section and backward ideal points.

Lemma 4.14 *The collection \mathcal{U}_x for x in $\tilde{M} \cup \mathcal{R}$ defines a neighborhood system and consequently a topology \mathcal{T}' in $\tilde{M} \cup \mathcal{R}$.*

Proof For x in \tilde{M} this is clear. In the other 2 cases it is easy to see that Properties (1) and (3) of neighborhood systems always hold: (3) is obvious by definition and (1) holds because the cell decomposition elements (in $\partial(\mathcal{D} \times [-1, 1])$) are always contained in the sets V_l or A_δ .

We now check Property (2). Suppose first that x is of type (ii). Let $x = \varphi(b)$. Let V_1, V_2 in \mathcal{U}_x , with V_1 defined by l and V_2 defined by r leaves of \mathcal{O}^s or \mathcal{O}^u . Then there is l' in \mathcal{O}^s or \mathcal{O}^u so that $l' \cup \partial l'$ separates b from $r \cup l$ in \mathcal{D} . Then $U_{l'}$ is contained in $U_l \cap U_r$ and we are done.

Let now x be of type (iii). Let U_1, U_2 be neighborhoods of x , where U_i contains A_i of the form $A_i = A(l_1^i, \dots, l_n^i, r_1^i, \dots, r_n^i, \tau_i)$ as in Definition 4.13, so that for each i , l_1^i, l_n^i are close to the same line leaf of l and r_1^i, r_n^i define small neighborhoods of a_i . Choose l_1^3 closer to l than both l_1^1 and l_1^2 and r_1^3 closer to a_i than both r_1^1 and r_1^2 . Let B_3 be the compact region of \mathcal{O} defined by the l_1^3, r_1^3 . Choose a section τ_3 in B_3 so that in the intersection $B_3 \cap (B_1 \cup B_2)$ then τ_3 is greater than $\max(\tau_1, \tau_2)$. Then

$A_3 = A(l_1^3, \dots, l_n^3, r_1^3, \dots, r_n^3, \tau_3)$ is in \mathcal{U}_x and $A_3 \subset A_1 \cap A_2 \subset U_1 \cap U_2$. Hence \mathcal{U}_x is a neighborhood system for x in $\tilde{M} \cup \mathcal{R}$.

Therefore the collection $\{\mathcal{U}_x, x \in \tilde{M} \cup \mathcal{R}\}$ defines a topology in $\tilde{M} \cup \mathcal{R}$. □

Lemma 4.15 *The quotient topology \mathcal{T} in $\tilde{M} \cup \mathcal{R}$ and the neighborhood system topology \mathcal{T}' are the same topology. This implies that the quotient topology in \mathcal{R} and the subspace topology from \mathcal{T}' in \mathcal{R} are also the same topology.*

Proof First let U in \mathcal{T}' and let x in U . If x is in \tilde{M} , then (i) of [Definition 4.13](#) shows that there is V open in (usual topology) of \tilde{M} with $x \in V \subset U$. If x is in \mathcal{R} let $g = \eta^{-1}(x)$. By construction if x is of type (ii) or (iii) as in [Definition 4.13](#), then $\eta^{-1}(U)$ contains an open set in $\mathcal{D} \times [-1, 1]$ which contains g . This shows that $\eta^{-1}(U)$ is an open set in $\mathcal{D} \times [-1, 1]$ and hence U is in \mathcal{T} .

Conversely let U in \mathcal{T} . Then $\eta^{-1}(U)$ is open in $\mathcal{D} \times [-1, 1]$. Let x in U . If x is in \tilde{M} , then x is in the open set $\eta^{-1}(U) \cap \tilde{M} \subset \eta^{-1}(U)$ so $\eta^{-1}(U)$ is in \mathcal{U}_x .

Suppose then that x is in \mathcal{R} and let g the cell element of \mathcal{R} associated to x . For simplicity we assume that x is of type (iii) in [Definition 4.13](#), as type (ii) is analogous and easier to deal with. Let l (as in [Definition 4.13](#)(iii)) be the leaf of (say) \mathcal{O}^s with $l \times \{1\}$ a subset of g . Then $\eta^{-1}(U)$ is an open set in $\mathcal{D} \times [-1, 1]$ containing g . For any ideal point b of l , then $\eta^{-1}(U)$ contains an open neighborhood of $b \times [-1, 1]$ in $\mathcal{D} \times [-1, 1]$. Since b is a stable ideal point, there is an unstable leaf z defining a small neighborhood of b in \mathcal{D} so that $V_z \subset \eta^{-1}(U)$. We also consider for each line leaf of l a regular leaf e of \mathcal{O}^s close to this line leaf. Choose each e sufficiently close to l so that these e 's and the z 's as above define a compact polygon B in \mathcal{O} . As $\eta^{-1}(U)$ is open and contains $l \times \{1\}$, it follows that if the e 's are sufficiently close to l and the z 's sufficiently close to ∂l , then $B \times \{1\} \subset \eta^{-1}(U)$. As B is compact, there is a high enough section $\tau: B \rightarrow \tilde{M}$ so that $H_\tau \subset \eta^{-1}(U)$. This shows that $\eta^{-1}(U)$ contains one set of form A_δ as in [Definition 4.13](#)(iii) and so U is in \mathcal{U}_x . Since U is in \mathcal{U}_x for any x in U , it follows that U is open with respect to \mathcal{T}' . Hence \mathcal{T} is equal to \mathcal{T}' . □

Lemma 4.16 *The space $\tilde{M} \cup \mathcal{R}$ is compact.*

Proof Let $\{Z_\alpha\}_{\alpha \in \mathcal{I}}$ be an open cover of $\tilde{M} \cup \mathcal{R}$. This provides an open cover of \mathcal{R} which is compact. Hence there is a finite subcollection $Z_{\alpha_1}, \dots, Z_{\alpha_n}$ whose union contains \mathcal{R} . Then

$$C = \tilde{M} \cup \mathcal{R} - \left(\bigcup_{i=1}^n Z_{\alpha_i} \right) \subset \tilde{M}$$

is closed. Since the topology in \widetilde{M} is the same as the induced topology from $\widetilde{M} \cup \mathcal{R}$, it follows that C is closed in \widetilde{M} and hence compact and it has a finite subcover. This finishes the proof. \square

Here is another way to see that $\pi_1(M)$ acts on $\widetilde{M} \cup \mathcal{R}$: Let γ in $\pi_1(M)$. Then γ takes sets of the form V_l (of (ii) of Definition 4.13) for l in \mathcal{O}^s or \mathcal{O}^u to $V_{\gamma(l)}$. Sections $\tau: B \rightarrow \widetilde{M}$ over compact sets B in \mathcal{O} are taken to sections over compact sets $\gamma(B)$ by γ . Hence $\pi_1(M)$ preserves the collection of sets described in Definition 4.13(ii)–(iii). Therefore γ takes neighborhoods $\widetilde{M} \cup \mathcal{R}$ to neighborhoods and consequently $\pi_1(M)$ acts by homeomorphisms on $\widetilde{M} \cup \mathcal{R}$.

We stress that it is hard to find open sets in $\widetilde{M} \cup \mathcal{R}$ explicitly: for example if l is a nonsingular leaf of \mathcal{O}^s , with corresponding open set V_l in $\mathcal{D} \times [-1, 1]$, it is not true that $\eta(V_l)$ is open in $\widetilde{M} \cup \mathcal{R}$, because V_l is not saturated by the equivalence relation defining the quotient: Certainly $V_l \cap \widetilde{M}$ is open in \widetilde{M} and $V_l \cap (\mathcal{D} \times \{1\})$ is both open and saturated in $\mathcal{D} \times \{1\}$. However $V_l \cap (\mathcal{D} \times \{-1\})$ is *not* saturated. Take any leaf s of \mathcal{O}^u intersecting l . Then $s \times \{-1\}$ intersects V_l but is not contained in V_l . Those leaves $s \times \{-1\}$ would have to be contained in a saturation of V_l . But their ideal points propagate through $\partial\mathcal{O} \times [-1, 1]$ and then propagate in the top $\mathcal{D} \times \{1\}$ through stable leaves.

Lemma 4.17 *The space $\widetilde{M} \cup \mathcal{R}$ is first countable.*

Proof We only need to check this for x in \mathcal{R} since \widetilde{M} is a manifold and is open in $\widetilde{M} \cup \mathcal{R}$. Suppose $\varphi^{-1}(x) = \{a_1, \dots, a_{i_0}\}$, all ideal points of a stable leaf l . The other cases are either similar or simpler. For each $1 \leq i \leq i_0$, we will construct a nested sequence of unstable leaves $(s_i^n)_{n \in \mathbb{N}}$ forming a master sequence defining a_i . For each line leaf l_i of l we will construct a nested sequence of nonsingular stable leaves $(l_i^n)_{n \in \mathbb{N}}$ converging to l_i in that sector of l . Suppose that l_i^n, l_{i+1}^n ($i \bmod (i_0)$) bound a small segment T_i^n in $\partial\mathcal{O}$ containing a_i in its interior. We do the construction so that for all n and i , the leaves l_i^n, l_{i+1}^n intersect s_i^n transversely. Then for each n

$$l_1^n, \dots, l_{i_0}^n, s_1^n, \dots, s_{i_0}^n$$

defines a compact set B_n in \mathcal{O} . It is not true that $B_j \subset B_i$ if $j > i$. Fix a section $\tau_1: B_1 \rightarrow \widetilde{M}$. We will choose sections $\tau_n: B_n \rightarrow \widetilde{M}$ so that for each n , $\tau_n(B_{n-1} \cap B_n)$ is flow forward of $\tau_{n-1}(B_{n-1} \cap B_n)$ and the flow length from $\tau_1(B_n \cap B_1)$ to $\tau_n(B_n \cap B_1)$ goes to infinity uniformly in n .

Let $A_n = A(l_1^n, \dots, l_{i_0}^n, r_1^n, \dots, r_{i_0}^n, \tau_n)$. Notice that $\eta(A_n)$ is not open in $\widetilde{M} \cup \mathcal{R}$ because A_n is not saturated. However we will choose A_n inductively so that there is

an open set U_n in $\widetilde{M} \cup \mathcal{R}$ satisfying

$$\eta(A_{n-1}) \supset U_n \supset \eta(A_n)$$

Here is the construction. Suppose that $l_1^{n-1}, \dots, l_{i_0}^{n-1}, s_1^{n-1}, \dots, s_{i_0}^{n-1}$ have been chosen. We choose one set $l_i^n, 1 \leq i \leq i_0$ closer to l than l_i^{n-1} and s_i^n closer to a_i than s_i^{n-1} . We will adjust these choices as needed.

Let x in $\eta(A_n)$. Certainly we can choose the section τ_n so that if x is in $\eta(A_n)$ and x is in \widetilde{M} then x is in the interior of $\eta(A_{n-1})$. Therefore assume that x is in \mathcal{R} and let y in $\eta^{-1}(x)$. There are 3 possibilities:

(A) First suppose that y is in $\mathcal{O} \times \{-1\}$.

Then y is in the region of $\mathcal{D} \times \{-1\}$ bounded by some $s_i^n \times \{-1\}$, which is strictly smaller than the region bounded by $s_i^{n-1} \times \{-1\}$. Let v be the leaf of \mathcal{O}^u with y in $v \times \{-1\}$. Then v is contained in the region $U_{s_i^{n-1}}$ and hence there is a set A_δ as in Definition 4.13(iii) associated to v and so that

$$A_\delta \subset U_{s_i^{n-1}} \subset A_{n-1}.$$

By definition $\eta(A_{n-1})$ is in \mathcal{U}_x because

$$\eta^{-1}(\eta(A_{n-1})) \supset A_{n-1} \supset A_\delta.$$

(B) The second case is that y is in $\partial\mathcal{O} \times [-1, 1]$, but y is not equivalent to any point in $\mathcal{O} \times \{1\}$ or $\mathcal{O} \times \{-1\}$, that is, y does not come from an ideal point of a leaf of \mathcal{O}^s or \mathcal{O}^u . Then y is in some $V_{s_i^n}$ and by Definition 4.13(ii), $\eta(A_{n-1})$ is a neighborhood of x in $\widetilde{M} \cup \mathcal{R}$.

(C) Finally suppose that y is in $\mathcal{O} \times \{1\}$.

If y is in the region of \mathcal{D} bounded by the $l_i^n, 1 \leq i \leq i_0$, then the proof as in part A) applies. The last case to analyze is y is $V_{s_i^n}$ for some i . Here y is in $u \times \{1\}$ with u a leaf of \mathcal{O}^s . In this case we adjust s_i^n so that its endpoints are in the open interval T_i^{n-1} . Then all stable leaves near u are in the region bounded by l_i^{n-1}, l_{i+1}^{n-1} . This shows that $\eta(A_{n-1})$ is a neighborhood of $x = \eta(y)$.

The modification in part C) makes the $U_{s_i^n}$ smaller and hence one has to rechoose the l_i^n closer to l accordingly so that s_i^n intersects both l_i^n and l_{i+1}^n . With this modification it follows that $\eta(A_{n-1})$ is a neighborhood of any point x in $\eta(A_n)$ so there is an open set U_n in $\widetilde{M} \cup \mathcal{R}$ with $\eta(A_{n-1}) \supset U_n \supset \eta(A_n)$.

As the sequence (l_i^n) converges to a line leaf of l for each i , (s_i^n) converges to a_i and $\tau_n(B_n)$ escapes in the positive direction, then it is now clear that the collection $\{U_n\}_{n \in \mathbb{N}}$ forms a countable basis for the topology of $\widetilde{M} \cup \mathcal{R}$ at x . □

This result will be used in [Section 5](#).

Finally we show that the action of $\pi_1(M)$ on $\tilde{M} \cup \mathcal{R}$ is a convergence group action. The description of the topology in $\tilde{M} \cup \mathcal{R}$ using neighborhood systems is extremely useful for this result.

Theorem 4.18 *Let Φ be a pseudo-Anosov flow without perfect fits, not conjugate to a suspension Anosov flow. Then the induced action of $\pi_1(M)$ on $\tilde{M} \cup \mathcal{R}$ is a convergence group action.*

Proof Let $(\gamma_n)_{n \in \mathbb{N}}$ be a sequence of distinct elements in $\pi_1(M)$. Since the action of $\pi_1(M)$ on \mathcal{R} is a convergence group action, then up to subsequence we can assume there are x, y in \mathcal{R} with (γ_n) converging locally uniformly to x in $\mathcal{R} - \{y\}$. We want to show that (γ_n) converges locally uniformly to x when acting on $(\tilde{M} \cup \mathcal{R}) - \{y\}$. Let C be a compact set in $\tilde{M} \cup \mathcal{R} - \{y\}$. Recall the surjective map $\varphi: \partial\mathcal{O} \rightarrow \mathcal{R}$.

Case 1 $\varphi^{-1}(y) = \{e\}$ – a single point.

Then $\eta^{-1}(y)$ is a vertical segment in $\partial\mathcal{O} \times I$. For any neighborhood U of y in $\tilde{M} \cup \mathcal{R}$, there is l an unstable (or stable) leaf defining a small neighborhood of e in \mathcal{D} so that $V_l \subset \eta^{-1}(U)$, V_l as in [Definition 4.13](#). If C is disjoint from U then

$$\eta^{-1}(C) \subset \mathcal{D} \times I - V_l.$$

Let Z be the closure of the segment of $(\partial\mathcal{O} - \partial l)$ not containing e (this is almost all of $\partial\mathcal{O}$). By the source/sink property of y, x for the sequence (γ_n) acting on \mathcal{R} , the set $\gamma_n(Z)$ is very near $\varphi^{-1}(x)$ for n big. As $\gamma_n(Z)$ is a segment in $\partial\mathcal{O}$, then there is a single point b in $\varphi^{-1}(x)$ with $\gamma_n(Z)$ near b for n big. It follows that $\gamma_n(\mathcal{D} \times I - V_l)$ is very near $\{b\} \times [-1, 1]$ in $\mathcal{D} \times [-1, 1]$ and so $\gamma_n(\eta^{-1}(C))$ is very near $\{b\} \times [-1, 1]$ in $\mathcal{D} \times [-1, 1]$. We conclude that $\gamma_n(C)$ is very near $x = \eta(\{b\} \times [-1, 1])$ in $\tilde{M} \cup \mathcal{R}$ as desired. This finishes the analysis of Case 1.

Case 2 $\varphi^{-1}(y) = \{a_1, \dots, a_{i_0}\}$, with $i_0 \geq 2$.

Suppose for simplicity that $\{a_1, \dots, a_{i_0}\}$ are the ideal points of $\mathcal{O}^s(p) = l$ for some p in \mathcal{O} . Let C be a compact set in $\tilde{M} \cup \mathcal{R} - \{y\}$. As before there are $\{l_i\}_{1 \leq i \leq i_0}$ regular leaves of \mathcal{O}^s very near the line leaves of l and there are $\{r_i\}_{1 \leq i \leq i_0}$, regular leaves of \mathcal{O}^u defining small neighborhoods of a_i so that the l_i 's together with the r_i 's define a compact set B in \mathcal{O} and there is a section $\tau: B \rightarrow \tilde{M}$ with

$$A = A(l_1, \dots, l_{i_0}, r_1, \dots, r_{i_0}, \tau) \quad \text{and} \quad \eta^{-1}(C) \subset \mathcal{D} \times [-1, 1] - A.$$

Assume that r_i intersects $l_i, l_{i+1} \pmod{i_0}$ and has ideal points near a_i . Since r_i, l_i are regular we need to be careful. Let \tilde{r}_i be the component of $\mathcal{O} - r_i$ which has a_i in

its closure (in $\mathcal{D} = \mathcal{O} \cup \partial\mathcal{O}$). Let also \tilde{l}_i be the component of $\mathcal{O} - l_i$ not containing the other l_j . Then consider the sets U_{r_i} and U_{l_i} as in Definition 3.18. The endpoints of l_i bound a closed interval I_i in $\partial\mathcal{O}$ contained in the closure of U_{l_i} (they do not contain any a_j). Similarly the endpoints of r_i bound a very small closed interval J_i in $\partial\mathcal{O}$ containing a_i . As in Definition 4.13, let $V_{r_i} = U_{r_i} \times [-1, 1]$ and let $H_\tau = \{\tilde{\Phi}_t(z) \mid z \in \tau(B) \text{ and } t \geq 0\} \cup (B \times \{1\})$. The sets C and A will be fixed for the rest of the proof of Case 2.

Let $\varphi^{-1}(x) = \{b_1, \dots, b_{j_0}\}$.

Case 2.a The union $\cup_i \gamma_n(\partial l_i)$ is eventually (with n) always very near a single point b_1 in $\varphi^{-1}(x)$.

Since γ_n restricted to compact sets of $(\partial\mathcal{O} - \varphi^{-1}(y))$ has image very close to $\varphi^{-1}(x)$ for n big, it follows that for all i , $1 \leq i \leq i_0$ then $\gamma_n(I_i)$ is very close to b_1 in \mathcal{D} . This implies that $\gamma_n(V_{l_i})$ is very close to $\{b_1\} \times [-1, 1]$ in $\mathcal{D} \times [-1, 1]$. In addition since the γ_n are homeomorphisms of $\partial\mathcal{O}$, then there is a single i (assume for simplicity that $i = 1$) so that $\gamma_n(J_1)$ is almost all of $\partial\mathcal{O}$ and hence $\gamma_n(\partial\mathcal{O} - J_1)$ is very close to b_1 . Notice that

$$\mathcal{D} \times [-1, 1] - (H_\tau \cup V_{r_1} \cup \dots \cup V_{r_n}) \subset \mathcal{D} \times [-1, 1] - V_{r_1}.$$

By the above $\gamma_n(\mathcal{D} \times [-1, 1] - V_{r_1})$ is very close to $\{b_1\} \times [-1, 1]$ in $\mathcal{D} \times [-1, 1]$. It follows that $\gamma_n(C)$ is very close to x for n big. This finishes the analysis in this case.

Case 2.b The union $\cup_i \gamma_n(\partial l_i)$ gets closer to more than one point in $\varphi^{-1}(x)$.

We first explain why the b_i are ideal points of an *unstable* leaf in this case. To start we claim that, for a single i , the ideal points of $\gamma_n(l_i)$ are close to a single point in $\varphi^{-1}(x)$ for n big. Let c_1, c_2 be the endpoints of l_i . If the claim is not true, then up to subsequence the sequences $(\gamma_n(c_1))$, $(\gamma_n(c_2))$ converge to two distinct points d_1, d_2 in $\varphi^{-1}(x)$. It follows that $\gamma_n(U_{l_i} \cap \partial\mathcal{O})$ contains most of a segment with endpoints d_1, d_2 . This contradicts the fact that $\gamma_n(U_{l_i} \cap \partial\mathcal{O})$ converges to points in $\varphi^{-1}(x)$. This proves the claim.

The hypothesis of Case 2.b implies that there is some i so that the ideal points of $\gamma_n(l_i), \gamma_n(l_{i+1})$ are not close. But $\gamma_n(r_i)$ intersects both of these leaves, hence the escape lemma implies that up to subsequence $(\gamma_n(r_i))$ converges to a leaf s of \mathcal{O}^u . The source/sink property for y, x implies that the ideal points of $\gamma_n(r_i)$ have to be getting close to points in $\varphi^{-1}(x)$. It follows that $\varphi^{-1}(x) = \partial s$ with s an unstable leaf, as we desired to show.

For any neighborhood W of x in $\tilde{M} \cup \mathcal{R}$ there is a set D in $\mathcal{D} \times [-1, 1]$ as in Definition 4.13: D is defined by s_1, \dots, s_{j_0} regular leaves of \mathcal{O}^u near line leaves of s ;

also t_1, \dots, t_{j_0} regular leaves of \mathcal{O}^s , where t_j defines a small neighborhood U_{t_j} of b_j in \mathcal{D} . The $s_j, t_j, 1 \leq j \leq j_0$ jointly bound a compact set B' in \mathcal{O} , consider a section $\nu: B' \rightarrow \widetilde{M}$ and E_ν the set of points flow backwards from $\nu(B')$ union $(B' \times [-1, 1])$:

$$E_\nu = \widetilde{\Phi}_{(-\infty, 0]}(\nu(B')) \cup (B' \times \{-1\})$$

Let $D = D(s_1, \dots, s_{j_0}, t_1, \dots, t_{j_0}, \nu) = \left(\bigcup_{1 \leq j \leq j_0} V_{t_j} \right) \cup E_\nu$.

Then there is such a D so that $D \subset \eta^{-1}(W)$. Fix one such D . We want to show that $\gamma_n(C)$ is eventually contained in W in $\widetilde{M} \cup \mathcal{R}$. It suffices to show that $\gamma_n(D \times [-1, 1] - A) \subset D$ in $\mathcal{D} \times [-1, 1]$. In Case 2.b an argument in \widetilde{M} will be needed. For the fixed B as above with section $\tau: B \rightarrow \widetilde{M}$, let E_τ be the set of points flow backwards from the section $\tau(B)$ union $B \times \{-1\}$ (just as E_ν was defined). Hence $B \times [-1, 1]$ is the union of E_τ, H_τ and the intersection of E_τ, H_τ is equal to $\tau(B)$. Notice that

$$D \times [-1, 1] - A \subset \left(\bigcup_{1 \leq i \leq i_0} V_{l_i} \right) \cup E_\tau.$$

Choose leaves l_i close enough to l so that the length of any segment of $\widetilde{\Lambda}^u \cap \tau(B)$ from $\tau(l_i)$ to $\tau(l_j)$ is very small. This yields a smaller neighborhood of y (V_{l_i} is bigger) and we show that the complement of this neighborhood of y goes near x under γ_n . For any i , the endpoints of $\gamma_n(l_i)$ converge to a single point in $\varphi^{-1}(x)$ as $n \rightarrow \infty$. Hence $\gamma_n(l_i)$ also does and so $\gamma_n(V_{l_i})$ gets very near $\varphi^{-1}(x) \times [-1, 1]$ in $\mathcal{D} \times [-1, 1]$.

In order to finish the proof in Case 2.b we need to analyze $\gamma_n(E_\tau)$. We modify the leaves s_j to be close enough to s , and the leaves t_j to be close enough to b_j and extend the section $\nu(B')$ so that any unstable segment in $\nu(B')$ connecting $t_j \times \mathbf{R}$ to $t_k \times \mathbf{R}$ has very large length. This decreases the set D , so we still have $D \subset \eta^{-1}(W)$.

Up to subsequence suppose there are z'_n in E_τ so that $\gamma_n(z'_n)$ are not in D . If c is an ideal point of r_i in $\partial\mathcal{O}$, then $\gamma_n(c)$ converges to a point in $\varphi^{-1}(x)$ in $\partial\mathcal{O}$. Let C_n be the closed, connected region in \mathcal{D} bounded by the union of the $\gamma_n(r_i), 1 \leq i \leq i_0$ union its ideal points. Then $\gamma_n(z'_n)$ is in $C_n \times [-1, 1]$. The bottom of this set is $C_n \times \{-1\}$ which is contained in D for n big. Hence if $\gamma_n(z'_n)$ is not in D the following happens: First $\gamma_n(z'_n)$ is in $B' \times (-1, 1)$, in particular $\gamma_n(z'_n)$ is in $\widetilde{M} = \mathcal{O} \times (-1, 1)$. Second, as $\gamma_n(z'_n)$ is not in E_ν then $\gamma_n(z'_n)$ is flow forward from a point in $\nu(B')$. As $z'_n \in E_\tau$, flow z'_n forward to a point z_n in the section $\tau(B)$. Hence $\gamma_n(z_n)$ is still flow forward of a point in $\nu(B')$.

Now consider the segment v_n which is the intersection of $\widetilde{W}^u(z_n)$ with the section $\tau(B)$. By construction this segment has arbitrarily small length and hence so

does the segment $\gamma_n(v_n)$ in $\widetilde{W}^u(\gamma_n(z_n))$, because γ_n acts as an isometry on \widetilde{M} . This segment $\gamma_n(v_n)$ is entirely flow forward of $\nu(B')$. Flow $\gamma_n(v_n)$ backwards until it hits the section $\nu(B')$. The unstable length gets decreased when flowing backwards or at least it does not increase too much, so it is a small length.

The segment v_n has endpoints in $l_i \times \mathbf{R}$ and $l_j \times \mathbf{R}$ for some i, j . The endpoints of $\gamma_n(v_n)$ are in $G_i = \gamma_n(l_i \times \mathbf{R})$ and $G_j = \gamma_n(l_j \times \mathbf{R})$ which, for n sufficiently big, are contained in the union of $V_{t_k}, 1 \leq k \leq j_0$. Notice that the boundary of V_{t_k} is the stable leaf $t_k \times \mathbf{R}$. If both G_i and G_j are contained in the same V_{t_k} this forces $\gamma_n(l_i)$ to be contained in V_{t_k} because its endpoints are in this set and an unstable leaf cannot intersect the stable leaf boundary more than once. But then $\gamma_n(z'_n)$ is in D and we finish the analysis. The remaining possibility is that G_i is in some V_{t_k} and G_j is in some V_{t_m} with $j \neq m$. Therefore $\gamma_n(v_n)$ flows back to a segment which has a subsegment from $t_k \times \mathbf{R}$ to $t_m \times \mathbf{R}$ in $\nu(B')$. This subsegment has fairly small length and this contradicts the choice of leaves $\{s_j, t_j, 1 \leq j \leq j_0\}$ and the section ν . This shows that $\gamma_n(z'_n)$ are in D contradiction to assumption.

This shows that $\gamma_n(E_\tau)$ is contained in $D \subset \eta^{-1}(W)$. Hence in $\widetilde{M} \cup \mathcal{R}$, the sets $\gamma_n(\widetilde{M} \cup \mathcal{R} - \{y\})$ converge locally uniformly to x . This finishes the analysis of Case 2.b and hence finishes the proof that $\pi_1(M)$ acts as a convergence group on $\widetilde{M} \cup \mathcal{R}$. □

5 Connections with Gromov hyperbolicity

In this section we relate the flow ideal boundary and compactification with the large scale geometry of \widetilde{M} and Gromov hyperbolic spaces. Bowditch [7], following ideas of Gromov, gave a topological characterization of the action of a hyperbolic group on its ideal boundary.

Theorem 5.1 (Bowditch [7]) *Suppose that X is a perfect, metrizable compactum. Suppose that a group Γ acts on X , such that the induced action on the space of distinct triples is properly discontinuous and cocompact. Then Γ is a hyperbolic group. Moreover there is a natural Γ -equivariant homeomorphism of X into $\partial\Gamma$, where $\partial\Gamma$ is the Gromov ideal boundary of Γ .*

The Γ -equivariant homeomorphism $\alpha: X \rightarrow \partial\Gamma$ satisfies: if f is an element of Γ and a is the attracting fixed point of the action of f in X , then $\alpha(a)$ is the attracting fixed point of the action of f in $\partial\Gamma$. In our situation $X = \mathcal{R}$ and $\Gamma = \pi_1(M)$, which acts on X .

If $\pi_1(M^3)$ is Gromov hyperbolic, Gromov also showed that \widetilde{M} has a compactification with an ideal boundary [40; 38; 19]. It is equivariantly homeomorphic to the Gromov boundary of $\pi_1(M)$, which is denoted by S_∞^2 . The following is now an immediate consequence of Theorem 4.12.

Theorem 5.2 *Let Φ be a pseudo-Anosov flow without perfect fits, not conjugate to a suspension Anosov flow. Let \mathcal{R} be the flow ideal sphere. Theorem 4.12 shows that $\pi_1(M^3)$ acts as a uniform convergence group on \mathcal{R} . Bowditch’s theorem implies that $\pi_1(M)$ is Gromov hyperbolic and the action of $\pi_1(M)$ on \mathcal{R} is topologically conjugate to the action of $\pi_1(M)$ on the Gromov ideal boundary S_∞^2 of \widetilde{M} .*

Let $\zeta: \mathcal{R} \rightarrow S_\infty^2$ be the conjugacy given by Theorem 5.2. It is uniquely defined.

In addition to Theorem 5.2 we also prove that the group equivariant compactification $\widetilde{M} \cup \mathcal{R}$ is equivariantly homeomorphic to the Gromov compactification of \widetilde{M} . First we define a bijection

$$\xi: \widetilde{M} \cup \mathcal{R} \rightarrow \widetilde{M} \cup S_\infty^2 \quad \text{by } \xi(x) = x \text{ if } x \in \widetilde{M} \text{ and } \xi(x) = \zeta(x) \text{ if } x \in \mathcal{R}.$$

Clearly this map ξ is group equivariant: if γ is in $\pi_1(M)$ then $\xi(\gamma(x)) = \gamma(\xi(x))$.

Theorem 5.3 *The map $\xi: \widetilde{M} \cup \mathcal{R} \rightarrow \widetilde{M} \cup S_\infty^2$ is a group equivariant homeomorphism. The map $\varphi_1 = \xi \circ \varphi: \partial\mathcal{O} \rightarrow S_\infty^2$ is a group invariant Peano curve.*

Proof We only need to show that ξ is a homeomorphism. We know that \widetilde{M} is open in both $\widetilde{M} \cup \mathcal{R}$ and in $\widetilde{M} \cup S_\infty^2$ and the induced topology from both of these is the original topology of \widetilde{M} . Hence ξ is continuous in \widetilde{M} . Let x in \mathcal{R} . Lemma 4.17 showed that $\widetilde{M} \cup \mathcal{R}$ is first countable. Hence to check continuity of ξ at x we only need to verify what happens for sequences. Let then p_n in $\widetilde{M} \cup \mathcal{R}$ converging to x as n converges to infinity. Theorem 5.2 shows that ξ restricted to \mathcal{R} is continuous. Hence we may assume that p_n is in \widetilde{M} . Then there are q_n in a fixed compact set in \widetilde{M} and γ_n in $\pi_1(M)$ with $\gamma_n(q_n) = p_n$. We may assume that the γ_n are distinct otherwise up to subsequence all $\gamma_n = \gamma$ and γ_n sends q_n into a fixed compact set, contradiction.

By the convergence group action of $\pi_1(M)$ on $\widetilde{M} \cup \mathcal{R}$ (Theorem 4.18), there is a source/sink pair y, z for some subsequence of (γ_n) (still denoted (γ_n)). Since $\pi_1(M)$ also acts as a convergence group on $\widetilde{M} \cup S_\infty^2$ [31; 37], then for this subsequence there is another subsequence (denoted (γ_{n_i})) with a source/sink pair b, a for the action in $\widetilde{M} \cup S_\infty^2$. As the action of $\pi_1(M)$ on \mathcal{R} is equivariantly conjugate to the action on S_∞^2 , it follows that $\xi(y) = b$ and $\xi(z) = a$. Now

$$p_{n_i} = \gamma_{n_i}(q_{n_i}) \text{ converges to } x \text{ in } \widetilde{M} \cup \mathcal{R}$$

with q_{n_i} in a fixed compact set of \tilde{M} . It follows that x is the sink of the sequence (γ_{n_i}) acting on $\tilde{M} \cup \mathcal{R}$, so $x = z$.

Consider now the situation in $\tilde{M} \cup S_\infty^2$. Here $\xi(p_{n_i}) = \gamma_{n_i}(\xi(q_{n_i}))$ with q_{n_i} in a compact set of \tilde{M} . Then $\xi(q_{n_i})$ is in a compact set of \tilde{M} . By the convergence group property of $\pi_1(M)$ acting on $\tilde{M} \cup S_\infty^2$, then up to subsequence we may assume that $\gamma_{n_i}(\xi(q_{n_i}))$ converges to the sink $a = \xi(z) = \xi(x)$. This shows that for any sequence (p_n) converging to x in $\tilde{M} \cup \mathcal{R}$, there is a subsequence $(p_{n_i})_{i \in \mathbb{N}}$ with $\xi(p_{n_i})$ converging to $\xi(x)$ in $\tilde{M} \cup S_\infty^2$. It follows that ξ is continuous at x and so ξ is continuous. Since $\tilde{M} \cup \mathcal{R}$ is compact and Hausdorff then ξ is a homeomorphism.

Using this fact the second statement follows from the fact that the map $\varphi: \partial\mathcal{O} \rightarrow \mathcal{R}$ is group equivariant. This finishes the proof of the theorem. \square

6 Quasigeodesic flows and quasi-isometric singular foliations

In the last two sections of the article we obtain geometric consequences for flows and foliations. A flow Φ in a manifold N is quasigeodesic if in \tilde{N} , distance along flow lines of $\tilde{\Phi}$ is a bounded multiplicative distortion of ambient distance. Quasigeodesic flows are extremely useful [58; 40; 16; 29]. In this section we show that if Φ is a pseudo-Anosov flow without perfect fits, then Φ is quasigeodesic. This will produce new examples of quasigeodesic pseudo-Anosov flows. A foliation \mathcal{E} (singular or not) is quasi-isometric if distance along leaves of $\tilde{\mathcal{E}}$ is a bounded multiplicative distortion of ambient distance in \tilde{N} . This property is very important [58; 59; 46; 40; 16; 25; 28]. We show that the stable/unstable foliations of pseudo-Anosov flows without perfect fits are quasi-isometric. These results are consequences of Theorems 5.2, 5.3 and previous results. Notice that both properties are invariant under quasi-isometries: if Φ is a quasigeodesic flow and Φ' is topologically conjugate to Φ , then Φ' is also quasigeodesic. The same holds for the quasi-isometric property for foliations. A quasi-isometry is a map so that when lifted to the universal cover it is bilipschitz in the large.

Theorem 6.1 *Let Φ be a pseudo-Anosov flow without perfect fits. Then Φ is a quasigeodesic flow. In addition the foliations Λ^s, Λ^u are quasi-isometric foliations.*

Proof Suppose first that Φ is topologically conjugate to a suspension Anosov flow. If Φ' is a suspension Anosov flow and M has the solv metric, then $\tilde{\Phi}'$ is a flow by minimal geodesics and the stable and unstable foliations $\tilde{\Lambda}^{s'}, \tilde{\Lambda}^{u'}$ are foliations by totally geodesic surfaces. Therefore Φ is quasigeodesic and $\tilde{\Lambda}^s, \tilde{\Lambda}^u$ are quasi-isometric foliations.

For the remainder of the proof assume that Φ is not conjugate to a suspension Anosov flow. Since Φ has no perfect fits, [Theorem 5.2](#) shows that $\pi_1(M)$ is Gromov hyperbolic. We now show that Φ is quasigeodesic. We will prove 3 topological properties of the flow lines in $\tilde{M} \cup \mathcal{R}$ (and then transfer them to $\tilde{M} \cup S_\infty^2$):

Property 1 For each flow line α of $\tilde{\Phi}$ then it limits in a single point of \mathcal{R} denoted by α_+ and similarly for the backwards direction.

The flow line α can be seen as a vertical segment $\{y\} \times (-1, 1)$ in $\mathcal{D} \times [-1, 1]$ where y is in \mathcal{O} . Let q in α . Let $z = (y, 1)$ and let $x = \varphi(z)$ a point in \mathcal{R} . We claim that x is the limit of α in $\tilde{M} \cup \mathcal{R}$. Let g be the decomposition element of $\partial(\mathcal{D} \times [-1, 1])$ associated to z . For any neighborhood U of x in $\tilde{M} \cup \mathcal{R}$ there is a set type $A = A(l_1, \dots, l_n, r_1, \dots, r_n, \tau)$ ([Definition 4.13](#)) with $A \subset \eta^{-1}(U)$. The description of type (iii) in [Definition 4.13](#), shows that since z is in g any such set A as above contains $\tilde{\Phi}_t(q)$ for all t bigger than some t_0 . This shows that in $\tilde{M} \cup \mathcal{R}$ the flow line α forward converges to x .

Similarly let α_- be the negative ideal point of α . In fact for any q in \tilde{M} let $\alpha = \tilde{\Phi}_{\mathcal{R}}(q)$ and define $\mu_+(q) = \alpha_+$ and $\mu_-(q) = \alpha_-$. This defines functions $\mu_+, \mu_-: \tilde{M} \rightarrow \mathcal{R}$.

Property 2 For each flow line α of $\tilde{\Phi}$, then the ideal points α_+, α_- are distinct.

Let α be an orbit of $\tilde{\Phi}$ which is $\{y\} \times (-1, 1)$ for some y in $\partial\mathcal{O}$. Suppose that $(y, 1), (y, -1)$ project to the same point in \mathcal{R} . By the construction of [Theorem 4.3](#), if a point in $\mathcal{D} \times 1$ is identified to a point in $\mathcal{D} \times \{-1\}$ then at least one of them has to be in $\partial\mathcal{O} \times [-1, 1]$. Since y is in \mathcal{O} , this is not the case here. Therefore α_+, α_- are distinct in \mathcal{R} .

Property 3 The endpoint functions $\mu_+, \mu_-: \tilde{M} \rightarrow \mathcal{R}$ are continuous.

Given p in \tilde{M} , p is in $\{y\} \times (-1, 1)$ for some y in \mathcal{O} . For any neighborhood U of $\mu_+(p)$ then $\eta^{-1}(U)$ contains a set of type $A(l_1, \dots, l_n, r_1, \dots, r_n, \tau)$. By the description of neighborhoods in [Definition 4.13](#), then for any q sufficiently near p then the forward orbit of q is eventually in $A(l_1, \dots, l_n, r_1, \dots, r_n, \tau)$ and so $\mu_+(q)$ is in U . This shows continuity of the map η_+ at x .

Since the map $\xi: \tilde{M} \cup \mathcal{R} \rightarrow \tilde{M} \cup S_\infty^2$ is a homeomorphism then as seen in $\tilde{M} \cup S_\infty^2$ Properties 1–3 also hold for orbits of $\tilde{\Phi}$. This is the key fact here: properties in $\tilde{M} \cup \mathcal{R}$ get transferred to $\tilde{M} \cup S_\infty^2$. We now use a result of Fenley and Mosher [[29](#)] which states that if $\pi_1(M)$ is Gromov hyperbolic and Properties 1–3 hold for orbits of a flow $\tilde{\Phi}$ then Φ is a uniform quasigeodesic flow. Hence Φ is a quasigeodesic flow.

We now prove that Λ^s, Λ^u are quasi-isometric singular foliations. Given that Φ is a quasigeodesic pseudo-Anosov flow, then it was proved in [25, Theorem 3.8] that Λ^s is quasi-isometric if and only if $\tilde{\Lambda}^s$ has Hausdorff leaf space and similarly for Λ^u . Suppose that $\tilde{\Lambda}^s$ does not have Hausdorff leaf space and let F, L not separated in $\tilde{\Lambda}^s$. Theorem 2.6 shows that F, L are connected by a chain of lozenges. A lozenge has 2 perfect fits, which are disallowed by hypothesis. Hence Λ^s, Λ^u are quasi-isometric foliations. This finishes the proof of Theorem 6.1. \square

7 Asymptotic properties of foliations

Here we show that \mathbf{R} -covered foliations and foliations with one sided branching in atoroidal manifolds are transverse to pseudo-Anosov flows without perfect fits and therefore satisfy the continuous extension property. This parametrizes and characterizes their limit sets. In addition this shows that pseudo-Anosov flows without perfect fits are very common.

Theorem 7.1 *Let \mathcal{F} be a Reebless \mathbf{R} -covered foliation in M^3 closed, atoroidal and not finitely covered by $\mathbf{S}^2 \times \mathbf{S}^1$. Then $\pi_1(M)$ is Gromov hyperbolic and \mathcal{F} satisfies the continuous extension property. This produces new examples of group invariant Peano curves.*

Proof Up to a double cover, we may assume that \mathcal{F} is transversely orientable. Recall that \mathbf{R} -covered means that the leaf space of $\tilde{\mathcal{F}}$ is homeomorphic to the reals \mathbf{R} . If \mathcal{F} is \mathbf{R} -covered and M is not finitely covered by $\mathbf{S}^2 \times \mathbf{S}^1$, then it was proved in [26; 10] that either there is a $\mathbf{Z} \oplus \mathbf{Z}$ subgroup of $\pi_1(M)$ or there is a pseudo-Anosov flow Φ transverse to \mathcal{F} and regulating for \mathcal{F} . Since M is (homotopically) atoroidal the second option occurs. Regulating means that every orbit of $\tilde{\Phi}$ intersects an arbitrary leaf of $\tilde{\mathcal{F}}$ and vice versa. Therefore the orbit space of $\tilde{\Phi}$ can be identified to the set of points in a leaf F of $\tilde{\mathcal{F}}$. Using Candel's theorem [14] we can assume that all leaves of \mathcal{F} are hyperbolic. In this situation the set $\mathcal{D} = \mathcal{O} \cup \partial\mathcal{O}$ is naturally identified to the compactification of F with a circle at infinity $\partial_\infty F$. Here is why: The construction of Λ^s, Λ^u in [26; 10] is obtained by blowing down 2 transverse laminations which intersect the leaves of \mathcal{F} in geodesics. Therefore there are 2 geodesic laminations (stable and unstable) in F , whose complementary regions are finite sided ideal polygons [26; 10]. It follows that the ideal points of F are either ideal points of leaves of $\tilde{\Lambda}^s \cap F, \tilde{\Lambda}^u \cap F$ or have neighborhood systems defined by leaves of these. Hence $\partial_\infty F$ is naturally homeomorphic to $\partial\mathcal{O}$ and $F \cup \partial_\infty F$ is homeomorphic to $\mathcal{O} \cup \partial\mathcal{O}$. This works for any F in $\tilde{\mathcal{F}}$.

Suppose there is a perfect fit between a leaf L of $\tilde{\Lambda}^s$ and a leaf H of $\tilde{\Lambda}^u$. Then in \mathcal{O} there are rays of $\Theta(L), \Theta(H)$ defining the same ideal point in $\partial\mathcal{O}$. By the above description there is a pair of geodesics in F , one stable and one unstable with the same ideal point in $\partial_\infty F$. By hyperbolic geometry considerations these 2 geodesics are asymptotic in F , so projecting to M and taking limits we obtain a leaf of \mathcal{F} so that there is a geodesic which is a leaf of both the stable and unstable laminations. This contradicts the fact that the stable and unstable laminations are transverse.

It follows that Φ has no perfect fits. By [Theorem 5.2](#) it follows that $\pi_1(M)$ is Gromov hyperbolic (this particular fact was already known, by the Gabai–Kazez theorem [\[35\]](#) and results in [\[26; 10; 27\]](#)). By [Theorem 6.1](#) it follows that Φ is a quasigeodesic pseudo-Anosov flow and in addition the map $\varphi_1: \partial\mathcal{O} \rightarrow S_\infty^2$ is a group equivariant Peano curve. The previously known examples of such group invariant Peano curves occurred for fibrations [\[16\]](#) and slitherings by work of Thurston [\[61\]](#). The results here are useful because Calegari [\[9\]](#), showed that there are many examples of \mathbf{R} –covered foliations in hyperbolic 3–manifolds which are not slitherings or uniform foliations. The results here imply the previous results for fibrations and slitherings.

Now we analyze the continuous extension property for the leaves of $\tilde{\mathcal{F}}$. Since Φ is quasigeodesic and transverse to \mathcal{F} , then the main theorem in [\[28\]](#) implies that leaves of $\tilde{\mathcal{F}}$ extend continuously to S_∞^2 . Hence \mathcal{F} has the continuous extension property. This finishes the proof of [Theorem 7.1](#). We remark that there is a direct proof of the continuous extension property in this case since $\partial\mathcal{O}$ is naturally identified to $\partial_\infty F$. For simplicity we just quote the result of [\[28\]](#). Notice that the leaves of $\tilde{\mathcal{F}}$ have limit set the whole sphere, so each leaf F of $\tilde{\mathcal{F}}$ produces a sphere filling curve. \square

We now turn to foliations with one sided branching.

Theorem 7.2 *Let \mathcal{F} be a Reebless foliation with one sided branching in M^3 closed, atoroidal and not finitely covered by $\mathbf{S}^2 \times \mathbf{S}^1$. Then $\pi_1(M)$ is Gromov hyperbolic. There is a pseudo-Anosov flow Φ transverse to \mathcal{F} which has no perfect fits and hence is a quasigeodesic flow and its stable/unstable foliations are quasi-isometric. It follows that \mathcal{F} has the continuous extension property.*

Proof Recall that \mathcal{F} has one sided branching if the leaf space of $\tilde{\mathcal{F}}$ is not Hausdorff, but the non-Hausdorff behavior occurs only in (say) the negative direction. Since \mathcal{F} has one sided branching it is transversely oriented. Suppose that $\tilde{\mathcal{F}}$ has branching only in the negative direction. When M is atoroidal and not finitely covered by $\mathbf{S}^2 \times \mathbf{S}^1$, Calegari [\[11\]](#) produced a pseudo-Anosov flow Φ which is transverse to \mathcal{F} and forward regulating for \mathcal{F} . Forward regulating means that if x is in a leaf F of $\tilde{\mathcal{F}}$ and L is

a leaf of $\widetilde{\mathcal{F}}$, for which there is a positive transversal from F to L , then the forward orbit of x intersects L .

As in the \mathbf{R} -covered case this is obtained from 2 laminations transverse to \mathcal{F} which intersect the leaves of $\widetilde{\mathcal{F}}$ in a collection of geodesics. Suppose there is G in $\widetilde{\Lambda}^s$ and H in $\widetilde{\Lambda}^u$ forming a perfect fit. Then G intersects F_0 leaf of $\widetilde{\mathcal{F}}$ and H intersects F_1 . Since \mathcal{F} has one sided branching there is a leaf F of $\widetilde{\mathcal{F}}$ with positive transversals from F_0 to F and from F_1 to F . By the above property G and H intersect F . There are rays in $\Theta(G)$ and $\Theta(H)$ with same ideal point p in $\partial\mathcal{O}$.

The ideal circle of \mathcal{O} is the same as the universal circle for the foliation \mathcal{F} in this case [11]. The universal circle is obtained as the inverse limit of circles at infinity escaping in the positive direction. Given A, B leaves of $\widetilde{\mathcal{F}}$ we write $A < B$ if there is a positive transversal from A to B . Given $A < B$ in $\widetilde{\mathcal{F}}$ then there is a dense set of directions in A which are asymptotic to B [11]. This is not symmetric – there is not a dense set of directions from B which is asymptotic to A . In our situation with $F_0 < F$ and $F_1 < F$ then the asymptotic directions from F to F_0 form an unlinked set with the asymptotic directions from F to F_1 [10; 11]. This implies there are natural surjective, continuous, weakly circularly monotone maps $\partial_\infty F \rightarrow \partial_\infty F_i$. The universal circle \mathcal{V} is obtained as an inverse limit of these maps.

The stable/unstable laminations are obtained by analysing the action of $\pi_1(M)$ in \mathcal{V} and producing laminations, that is, a collection of pairs of points in \mathcal{V} which are unlinked. They produce a collection of geodesics in leaves of $\widetilde{\mathcal{F}}$, without transverse intersections, which vary continuously in the transversal direction. Therefore if rays of $\Theta(G), \Theta(H)$ define the same ideal point in $\partial\mathcal{O}$, then in the leaf F which they jointly intersect the following happens: the associated stable/unstable geodesics are asymptotic. As in the \mathbf{R} -covered case this leads to a contradiction to $\widetilde{\Lambda}^s, \widetilde{\Lambda}^u$ being transverse.

We conclude that Φ has no perfect fits. From this point on the proof follows the same arguments as in the \mathbf{R} -covered case. □

Corollary 7.3 *Let \mathcal{F} be a Reebless foliation with one sided branching in M^3 atoroidal and not finitely covered by $\mathbf{S}^2 \times \mathbf{S}^1$. For any leaf F of $\widetilde{\mathcal{F}}$, then the limit set of F is not the whole sphere S_∞^2 .*

Proof The limit set of a set B in \widetilde{M} is the set of accumulation points of B in S_∞^2 . Suppose that there is branching of $\widetilde{\mathcal{F}}$ only in the negative direction. Choose E, L nonseparated from each other and so that $F < E$. Branching in the negative direction means that there is a sequence of leaves (G_n) on the positive side of E, L which

converges to both E, L . Since E, L are nonseparated from each other, then they do not intersect the same orbit of $\tilde{\Phi}$. Recall the projection map $\Theta: \tilde{M} \rightarrow \mathcal{O}$. The sets $\Theta(E), \Theta(L)$ are disjoint. Since E, L are nonseparated from each other in their positive sides, then the analysis in [28, Section 4], shows that there is a slice leaf S of an unstable leaf of $\tilde{\Lambda}^u$, so that $s = \Theta(S)$ is a boundary component of $\Theta(L)$ and s separates $\Theta(L)$ from $\Theta(E)$.

Then the limit set of S , Λ_S is a Jordan curve C – this is shown in [21; 25]. This uses the fact that Λ^s is a quasi-isometric foliation. The construction implies that the leaf E separates F from S – here we use that E, L are nonseparated from each other on their positive sides and F is in the back of E . Since S is disjoint from F then the limit set of F is contained in the closure of one complementary component of Λ_S in S_∞^2 . Therefore Λ_F is not S_∞^2 . \square

Remarks (1) The remaining open situation for the continuous extension property is that of \mathcal{F} with two sided branching. This means that the leaf space of $\tilde{\mathcal{F}}$ has non-Hausdorff behavior in both the positive and negative directions. The particular case of finite depth foliations was recently solved in [28] using completely different methods than this article. In particular in [28] one starts with strong geometric properties, namely that M is hyperbolic and there is a leaf which is quasi-isometrically embedded (the compact leaf) and this has enormous geometric consequences. The tools here are purely from dynamical systems.

(2) Many \mathbf{R} -covered examples in hyperbolic 3-manifolds which are not slitherings were constructed by Calegari in [9]. Many explicit examples of foliations with one sided branching were constructed by Meigniez in [45].

(3) Suppose that \mathcal{F} is Reebless in M^3 with $\pi_1(M)$ negatively curved. It is asked in [23; 28]: is \mathcal{F} \mathbf{R} -covered if and only if for some F in $\tilde{\mathcal{F}}$ then the limit set $\Lambda_F = S_\infty^2$? If \mathcal{F} is \mathbf{R} -covered then $\Lambda_F = S_\infty^2$ for every F in $\tilde{\mathcal{F}}$ [23]. The converse is true if there is a compact leaf in \mathcal{F} [39; 23]. The previous theorem shows that if \mathcal{F} has one sided branching then Λ_F is not S_∞^2 for any F in $\tilde{\mathcal{F}}$. Therefore the remaining open case for this question is also when \mathcal{F} has 2 sided branching.

(4) The results of this article show that foliations in manifolds with Gromov hyperbolic fundamental group are very similar to surface Kleinian groups: the \mathbf{R} -covered case corresponds to doubly degenerate surface Kleinian groups, where the limit sets are the whole sphere. The foliations with one sided branching correspond to singly degenerate Kleinian groups where there is a single component of the domain of discontinuity. It remains to be seen whether foliations with 2 sided branching behave like nondegenerate surface Kleinian groups.

References

- [1] **T Barbot**, *Caractérisation des flots d'Anosov en dimension 3 par leurs feuilletages faibles*, Ergodic Theory Dynam. Systems 15 (1995) 247–270 [MR1332403](#)
- [2] **T Barbot**, *Mise en position optimale de tores par rapport à un flot d'Anosov*, Comment. Math. Helv. 70 (1995) 113–160 [MR1314942](#)
- [3] **T Barbot**, *Actions de groupes sur les 1-variétés non séparées et feuilletages de codimension un*, Ann. Fac. Sci. Toulouse Math. 7 (1998) 559–597 [MR1693597](#)
- [4] **M Bestvina, M Feighn**, *A combination theorem for negatively curved groups*, J. Differential Geom. 35 (1992) 85–101 [MR1152226](#)
- [5] **M Bestvina, G Mess**, *The boundary of negatively curved groups*, J. Amer. Math. Soc. 4 (1991) 469–481 [MR1096169](#)
- [6] **C Bonatti, R Langevin**, *Un exemple de flot d'Anosov transitif transverse à un tore et non conjugué à une suspension*, Ergodic Theory Dynam. Systems 14 (1994) 633–643 [MR1304136](#)
- [7] **B H Bowditch**, *A topological characterisation of hyperbolic groups*, J. Amer. Math. Soc. 11 (1998) 643–667 [MR1602069](#)
- [8] **B H Bowditch**, *Convergence groups and configuration spaces*, from: “Geometric group theory down under (Canberra, 1996)”, (J Cossey, W D Neumann, M Shapiro, editors), de Gruyter, Berlin (1999) 23–54 [MR1714838](#)
- [9] **D Calegari**, *\mathbf{R} -covered foliations of hyperbolic 3-manifolds*, Geom. Topol. 3 (1999) 137–153 [MR1695533](#)
- [10] **D Calegari**, *The geometry of \mathbf{R} -covered foliations*, Geom. Topol. 4 (2000) 457–515 [MR1800151](#)
- [11] **D Calegari**, *Foliations with one-sided branching*, Geom. Dedicata 96 (2003) 1–53 [MR1956833](#)
- [12] **D Calegari**, *Promoting essential laminations*, Invent. Math. 166 (2006) 583–643 [MR2257392](#)
- [13] **D Calegari, N M Dunfield**, *Laminations and groups of homeomorphisms of the circle*, Invent. Math. 152 (2003) 149–204 [MR1965363](#)
- [14] **A Candel**, *Uniformization of surface laminations*, Ann. Sci. École Norm. Sup. 26 (1993) 489–516 [MR1235439](#)
- [15] **J W Cannon, E L Swenson**, *Recognizing constant curvature discrete groups in dimension 3*, Trans. Amer. Math. Soc. 350 (1998) 809–849 [MR1458317](#)
- [16] **J W Cannon, W P Thurston**, *Group invariant Peano curves*, Geom. Topol. 11 (2007) 1315–1355 [MR2326947](#)
- [17] **A J Casson, S A Bleiler**, *Automorphisms of surfaces after Nielsen and Thurston*, London Math. Soc. Student Texts 9, Cambridge Univ. Press (1988) [MR964685](#)

- [18] **A Casson, D Jungreis**, *Convergence groups and Seifert fibered 3-manifolds*, Invent. Math. 118 (1994) 441–456 [MR1296353](#)
- [19] **M Coornaert, T Delzant, A Papadopoulos**, *Géométrie et théorie des groupes: Les groupes hyperboliques de Gromov*, Lecture Notes in Math. 1441, Springer-Verlag, Berlin (1990) [MR1075994](#)
- [20] **A Fathi, F Laudenbach, V Poénaru, editors**, *Travaux de Thurston sur les surfaces*, Astérisque 66–67, Soc. Math. France, Paris (1979) [MR568308](#) Séminaire Orsay, In French with an English summary
- [21] **S R Fenley**, *Anosov flows in 3-manifolds*, Ann. of Math. 139 (1994) 79–115 [MR1259365](#)
- [22] **S R Fenley**, *Quasigeodesic Anosov flows and homotopic properties of flow lines*, J. Differential Geom. 41 (1995) 479–514 [MR1331975](#)
- [23] **S R Fenley**, *Limit sets of foliations in hyperbolic 3-manifolds*, Topology 37 (1998) 875–894 [MR1607756](#)
- [24] **S R Fenley**, *The structure of branching in Anosov flows of 3-manifolds*, Comment. Math. Helv. 73 (1998) 259–297 [MR1611703](#)
- [25] **S R Fenley**, *Foliations with good geometry*, J. Amer. Math. Soc. 12 (1999) 619–676 [MR1674739](#)
- [26] **S R Fenley**, *Foliations, topology and geometry of 3-manifolds: \mathbf{R} -covered foliations and transverse pseudo-Anosov flows*, Comment. Math. Helv. 77 (2002) 415–490 [MR1933786](#)
- [27] **S R Fenley**, *Pseudo-Anosov flows and incompressible tori*, Geom. Dedicata 99 (2003) 61–102 [MR1998929](#)
- [28] **S R Fenley**, *Geometry of foliations and flows I: Almost transverse pseudo-Anosov flows and asymptotic behavior of foliations*, J. Differential Geom. 81 (2009) 1–89 [MR2477891](#)
- [29] **S Fenley, L Mosher**, *Quasigeodesic flows in hyperbolic 3-manifolds*, Topology 40 (2001) 503–537 [MR1838993](#)
- [30] **J Franks, R Williams**, *Anomalous Anosov flows*, from: “Global theory of dynamical systems (Proc. Internat. Conf., Northwestern Univ., Evanston, Ill., 1979)”, (Z Nitecki, C Robinson, editors), Lecture Notes in Math. 819, Springer, Berlin (1980) 158–174 [MR591182](#)
- [31] **E M Freden**, *Negatively curved groups have the convergence property I*, Ann. Acad. Sci. Fenn. Ser. A I Math. 20 (1995) 333–348 [MR1346817](#)
- [32] **D Gabai**, *Convergence groups are Fuchsian groups*, Ann. of Math. 136 (1992) 447–510 [MR1189862](#)

- [33] **D Gabai**, *Problems in foliations and laminations*, from: “Geometric topology (Athens, GA, 1993)”, (W H Kazez, editor), AMS/IP Stud. Adv. Math. 2, Amer. Math. Soc., Providence, RI (1997) 1–33 [MR1470750](#)
- [34] **D Gabai**, *Quasi-minimal semi-Euclidean laminations in 3-manifolds*, from: “Surveys in differential geometry, Vol. III (Cambridge, MA, 1996)”, (S-T Yau, editor), Int. Press, Boston (1998) 195–242 [MR1677889](#)
- [35] **D Gabai, W H Kazez**, *Group negative curvature for 3-manifolds with genuine laminations*, *Geom. Topol.* 2 (1998) 65–77 [MR1619168](#)
- [36] **D Gabai, U Oertel**, *Essential laminations in 3-manifolds*, *Ann. of Math.* 130 (1989) 41–73 [MR1005607](#)
- [37] **F W Gehring, G J Martin**, *Discrete quasiconformal groups I*, *Proc. London Math. Soc.* 55 (1987) 331–358 [MR896224](#)
- [38] **É Ghys, P de la Harpe** (editors), *Sur les groupes hyperboliques d’après Mikhael Gromov*, *Progress in Math.* 83, Birkhäuser, Boston, MA (1990) [MR1086648](#) Papers from the Swiss Seminar on Hyperbolic Groups held in Bern, 1988
- [39] **S Goodman, S Shields**, *A condition for the stability of \mathbf{R} -covered on foliations of 3-manifolds*, *Trans. Amer. Math. Soc.* 352 (2000) 4051–4065 [MR1624178](#)
- [40] **M Gromov**, *Hyperbolic groups*, from: “Essays in group theory”, (S M Gersten, editor), *Math. Sci. Res. Inst. Publ.* 8, Springer, New York (1987) 75–263 [MR919829](#)
- [41] **M Handel**, *Global shadowing of pseudo-Anosov homeomorphisms*, *Ergodic Theory Dynam. Systems* 5 (1985) 373–377 [MR805836](#)
- [42] **J Hempel**, *3-Manifolds*, *Ann. of Math. Studies* 86, Princeton Univ. Press (1976) [MR0415619](#)
- [43] **JL Kelley**, *General topology*, Van Nostrand, Toronto-New York-London (1955) [MR0070144](#)
- [44] **BS Mangum**, *Incompressible surfaces and pseudo-Anosov flows*, *Topology Appl.* 87 (1998) 29–51 [MR1626072](#)
- [45] **G Meigniez**, *Bouts d’un groupe opérant sur la droite, II. Applications à la topologie des feuilletages*, *Tohoku Math. J.* 43 (1991) 473–500 [MR1133863](#)
- [46] **J W Morgan**, *On Thurston’s uniformization theorem for three-dimensional manifolds*, from: “The Smith conjecture (New York, 1979)”, (J W Morgan, H Bass, editors), *Pure Appl. Math.* 112, Academic Press, Orlando, FL (1984) 37–125 [MR758464](#)
- [47] **L Mosher**, *Dynamical systems and the homology norm of a 3-manifold II*, *Invent. Math.* 107 (1992) 243–281 [MR1144424](#)
- [48] **L Mosher**, *Examples of quasi-geodesic flows on hyperbolic 3-manifolds*, from: “Topology ’90 (Columbus, OH, 1990)”, (B Apanasov, W D Neumann, A W Reid, L Siebenmann, editors), *Ohio State Univ. Math. Res. Inst. Publ.* 1, de Gruyter, Berlin (1992) 227–241 [MR1184414](#)

- [49] **L Mosher**, *Laminations and flows transverse to finite depth foliations, Part I: Branched surfaces and dynamics*, preprint (1996) Available at <http://newark.rutgers.edu:80/~mosher/>
- [50] **L Mosher**, *Laminations and flows transverse to finite depth foliations, Part II*, in preparation
- [51] **J R Munkres**, *Topology: a first course*, second edition, Prentice-Hall, Englewood Cliffs, N.J. (2000) [MR0464128](#)
- [52] **J-P Otal**, *Thurston's hyperbolization of Haken manifolds*, from: "Surveys in differential geometry, Vol. III (Cambridge, MA, 1996)", (S-T Yau, editor), Int. Press, Boston (1998) 77–194 [MR1677888](#)
- [53] **J-P Otal**, *The hyperbolization theorem for fibered 3-manifolds*, SMF/AMS Texts and Monog. 7, Amer. Math. Soc. (2001) [MR1855976](#) Translated from the 1996 French original by L D Kay
- [54] **G Perelman**, *The entropy formulat for the Ricci flow and its geometric applications* [arXiv:math.DG/0211159](#)
- [55] **G Perelman**, *Ricci flow with surgery on 3-manifolds* [arXiv:math.DG/0303109](#)
- [56] **G Perelman**, *Finite extinction time for the solutions to the Ricci flow in certain 3-manifolds* [arXiv:math.DG/0307245](#)
- [57] **R Roberts, M Stein**, *Group actions on order trees*, *Topology Appl.* 115 (2001) 175–201 [MR1847462](#)
- [58] **W P Thurston**, *The geometry and topology of three-manifolds*, Princeton Univ. Math. Dept. Lecture Notes (1979) Available at <http://msri.org/publications/books/gt3m/>
- [59] **W P Thurston**, *Three-dimensional manifolds, Kleinian groups and hyperbolic geometry*, *Bull. Amer. Math. Soc.* 6 (1982) 357–381 [MR648524](#)
- [60] **W P Thurston**, *On the geometry and dynamics of diffeomorphisms of surfaces*, *Bull. Amer. Math. Soc.* 19 (1988) 417–431 [MR956596](#)
- [61] **W P Thurston**, *Three-manifolds, foliations and circles I* [arXiv:math.GT/9712268](#)
- [62] **W P Thurston**, *Hyperbolic structures on 3-manifolds II: Surface groups and 3-manifolds that fiber over the circle* [arXiv:math.GT/9801045](#)
- [63] **P Tukia**, *Homeomorphic conjugates of Fuchsian groups*, *J. Reine Angew. Math.* 391 (1988) 1–54 [MR961162](#)
- [64] **P Tukia**, *Convergence groups and Gromov's metric hyperbolic spaces*, *New Zealand J. Math.* 23 (1994) 157–187 [MR1313451](#)
- [65] **P Tukia**, *Conical limit points and uniform convergence groups*, *J. Reine Angew. Math.* 501 (1998) 71–98 [MR1637829](#)

- [66] **F Waldhausen**, *On irreducible 3–manifolds which are sufficiently large*, Ann. of Math. 87 (1968) 56–88 [MR0224099](#)
- [67] **RL Wilder**, *Topology of Manifolds*, Amer. Math. Soc. Colloq. Publ. 32, Amer. Math. Soc. (1949) [MR0029491](#)

Department of Mathematics, Florida State University
Room 208, 1017 Academic Way, Tallahassee FL 32306-4510, USA

fenley@math.fsu.edu

Proposed: Danny Calegari

Seconded: Benson Farb, Dmitri Burago

Received: 22 May 2009

Revised: 18 April 2011