

# On the universal $sl_2$ invariant of boundary bottom tangles

SAKIE SUZUKI

The universal  $sl_2$  invariant of bottom tangles has a universality property for the colored Jones polynomial of links. A bottom tangle is called boundary if its components admit mutually disjoint Seifert surfaces. Habiro conjectured that the universal  $sl_2$  invariant of boundary bottom tangles takes values in certain subalgebras of the completed tensor powers of the quantized enveloping algebra  $U_h(sl_2)$  of the Lie algebra  $sl_2$ . In the present paper, we prove an improved version of Habiro's conjecture. As an application, we prove a divisibility property of the colored Jones polynomial of boundary links.

57M27; 57M25

## 1 Introduction

In the 80s, Jones [9] constructed a polynomial invariant of links. After that, Reshetikhin and Turaev [20] defined an invariant of framed links whose components are colored by finite dimensional representations of a ribbon Hopf algebra. The *colored Jones polynomial* is the Reshetikhin–Turaev invariant of links whose components are colored by finite dimensional representations of the quantized enveloping algebra  $U_h(sl_2)$ .

The *universal invariant* associated with a ribbon Hopf algebra is an invariant of framed links and tangles whose components are not colored by any representations; see Hennings [8], Lawrence [13; 14], Reshetikhin [20], Ohtsuki [19], Kauffman [11] and Kauffman and Radford [12]. The universal invariant has the universality property for the Reshetikhin–Turaev invariant. By the *universal  $sl_2$  invariant*, we mean the universal invariant associated with  $U_h(sl_2)$ . In particular, one can obtain the colored Jones polynomial from the universal  $sl_2$  invariant.

A *bottom tangle* is a tangle consisting of arc components in a cube such that each boundary point is on the bottom line, and the two boundary points of each component are adjacent to each other; see Figure 1(a) for example. We can define the closure link of a bottom tangle; see Figure 1(b). For each link  $L$ , there is a bottom tangle whose closure is  $L$ . In [5], Habiro studied the universal invariant of bottom tangles associated with a ribbon Hopf algebra, and in [7], he studied the universal  $sl_2$  invariant in detail.

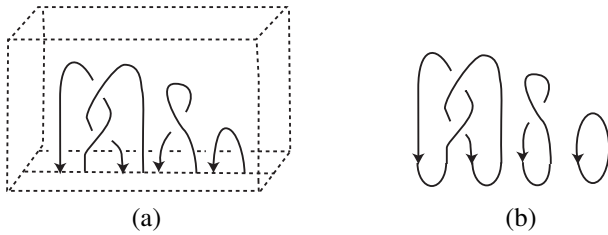

Figure 1. (a) A bottom tangle  $T$  (b) The closure link of  $T$

The universal  $sl_2$  invariant of  $n$ -component bottom tangles takes values in the completed  $n$ -fold tensor power  $U_h(sl_2)^{\widehat{\otimes} n}$  of  $U_h(sl_2)$ . By using bottom tangles, we can restate the universality of the universal  $sl_2$  invariant: the colored Jones polynomial of a link  $L$  is obtained from the universal  $sl_2$  invariant of a bottom tangle whose closure is  $L$ , by taking the quantum traces associated with the representations attached to the components of links (cf [5]).

We are interested in relationships between the algebraic properties of the colored Jones polynomial and the universal  $sl_2$  invariant and the topological properties of links and bottom tangles.

Eisermann [2] proved that the Jones polynomial of an  $n$ -component ribbon link is divisible by the Jones polynomial of the  $n$ -component unlink. Habiro [4] generalized this result to links which are ribbon concordant to boundary links. Habiro [7] also proved that the universal  $sl_2$  invariant of  $n$ -component, algebraically split, 0-framed bottom tangles takes values in certain small subalgebras of the completed tensor powers of  $U_h(sl_2)$ , and gave a divisibility property of the colored Jones polynomial of algebraically split, 0-framed links.

In [23], the present author proved improvements of Habiro's results for algebraically split, 0-framed bottom tangles and links, in the special case of *ribbon bottom tangles* and ribbon links.

In the present paper, we study the universal  $sl_2$  invariant of *boundary bottom tangles*. A bottom tangle is called *boundary* if its components admit mutually disjoint Seifert surfaces; see Figure 2 for example. We can obtain each boundary link from a boundary bottom tangle by closing. Habiro [7] conjectured that the universal  $sl_2$  invariant of boundary bottom tangles takes values in certain subalgebras of the completed tensor powers of  $U_h(sl_2)$ . We prove an improved version of Habiro's conjecture (Theorem 1.2), and give a divisibility property of the colored Jones polynomial of boundary links (Theorem 1.6).

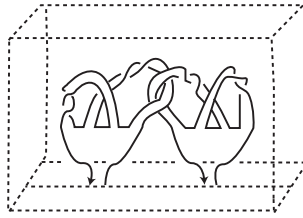

Figure 2. A boundary bottom tangle

### 1.1 Main result

The quantized enveloping algebra  $U_h = U_h(sl_2)$  is an  $h$ -adically completed  $\mathbb{Q}[[h]]$ -algebra (see Section 2.2 for the details). We set  $q = \exp h$ .

Habiro [7] proved that the universal  $sl_2$  invariant  $J_T$  of an  $n$ -component, algebraically split, 0-framed bottom tangle  $T$  is contained in the  $\mathbb{Z}[q, q^{-1}]$ -subalgebra  $(\tilde{U}_q^{ev})^{\hat{\otimes} n}$  of  $U_h^{\hat{\otimes} n}$ . In [23], we defined another  $\mathbb{Z}[q, q^{-1}]$ -subalgebra  $(\bar{U}_q^{ev})^{\wedge \hat{\otimes} n} \subset (\tilde{U}_q^{ev})^{\hat{\otimes} n}$ , and prove the following theorem. (See Section 2.3 for the definition of  $\bar{U}_q^{ev}$ , and see Sections 6.1–6.4 for the definition of the completion  $(\bar{U}_q^{ev})^{\wedge \hat{\otimes} n}$  of  $(\bar{U}_q^{ev})^{\otimes n}$ .)

**Theorem 1.1** [23] *Let  $T$  be an  $n$ -component ribbon bottom tangle with 0-framing. Then we have  $J_T \in (\bar{U}_q^{ev})^{\wedge \hat{\otimes} n}$ .*

The main result of the present paper is the following.

**Theorem 1.2** *Let  $T$  be an  $n$ -component boundary bottom tangle with 0-framing. Then we have  $J_T \in (\bar{U}_q^{ev})^{\wedge \hat{\otimes} n}$ .*

**Remark 1.3** Habiro [7, Conjecture 8.9] conjectured Theorem 1.2 with  $(\bar{U}_q^{ev})^{\wedge \hat{\otimes} n}$  replaced with the  $\mathbb{Z}[q, q^{-1}]$ -subalgebra  $(\bar{U}_q^{ev})^{\sim \hat{\otimes} n}$ , which includes  $(\bar{U}_q^{ev})^{\wedge \hat{\otimes} n}$ . The definition of our algebra  $(\bar{U}_q^{ev})^{\wedge \hat{\otimes} n}$  appears to be more natural than that of  $(\bar{U}_q^{ev})^{\sim \hat{\otimes} n}$ , though we do not know whether the inclusion  $(\bar{U}_q^{ev})^{\wedge \hat{\otimes} n} \subset (\bar{U}_q^{ev})^{\sim \hat{\otimes} n}$  is proper or not.

Since every 1-component bottom tangle is boundary, Theorem 1.2 for  $n = 1$  gives a possible improvement of the following theorem.

**Theorem 1.4** (Habiro) *Let  $T$  be an 1-component bottom tangle with 0-framing. Then we have  $J_T \in (\bar{U}_q^{ev})^{\sim}$ .*

Theorem 1.4 follows from [7, Theorem 4.1] and the equalities

$$\text{Inv}(\tilde{\mathcal{U}}_q^{\text{ev}}) = Z(\tilde{\mathcal{U}}_q^{\text{ev}}) = Z((\bar{U}_q^{\text{ev}})^\sim),$$

which is implicit in [6, Section 9]. Here, for a subset  $X \subset U_h$ , we denote by  $\text{Inv}(X)$  the invariant part of  $X$ , and by  $Z(X)$  the center of  $X$ .

If we use the one-to-one correspondence described in [5, Section 13] between the set of bottom tangles and the set of string links, then we can define the Milnor  $\mu$  invariants [17; 18] of a bottom tangle as that of the corresponding string link. See [3] for the Milnor  $\mu$  invariants of string links. In fact, all the Milnor  $\mu$  invariants vanish both for ribbon bottom tangles and for boundary bottom tangles. It is natural to expect the following conjecture.

**Conjecture 1.5** *Let  $T$  be an  $n$ -component bottom tangle with 0-framing with vanishing all the Milnor  $\mu$  invariants. Then we have  $J_T \in (\bar{U}_q^{\text{ev}})^{\widehat{\otimes} n}$ .*

The converse of Conjecture 1.5 is also open.

### 1.2 Application to the colored Jones polynomial

We give an application (Theorem 1.6) of Theorem 1.2 to the colored Jones polynomial of boundary links. This result is parallel to the result in [23] for ribbon links.

We use the following  $q$ -integer notation:

$$\begin{aligned} \{i\}_q &= q^i - 1, & \{i\}_{q,n} &= \{i\}_q \{i-1\}_q \cdots \{i-n+1\}_q, & \{n\}_q! &= \{n\}_{q,n}, \\ [i]_q &= \{i\}_q / \{1\}_q, & [n]_q! &= [n]_q [n-1]_q \cdots [1]_q, & \left[ \begin{matrix} i \\ n \end{matrix} \right]_q &= \{i\}_{q,n} / \{n\}_q!, \end{aligned}$$

for  $i \in \mathbb{Z}, n \geq 0$ .

For  $m \geq 1$ , let  $V_m$  denote the  $m$ -dimensional irreducible representation of  $U_h$ . Let  $\mathcal{R}$  denote the representation ring of  $U_h$  over  $\mathbb{Q}(q^{1/2})$ , ie,  $\mathcal{R}$  is the  $\mathbb{Q}(q^{1/2})$ -algebra

$$\mathcal{R} = \text{Span}_{\mathbb{Q}(q^{1/2})} \{V_m \mid m \geq 1\}$$

with the multiplication induced by the tensor product. It is well known that  $\mathcal{R} = \mathbb{Q}(q^{1/2})[V_2]$ .

For  $l \geq 0$ , set

$$\begin{aligned} P_l &= \prod_{i=0}^{l-1} (V_2 - q^{i+1/2} - q^{-i-1/2}) \in \mathcal{R}, \\ \tilde{P}'_l &= \frac{q^{(1/2)l}}{\{l\}_q!} P_l \in \mathcal{R}, \end{aligned}$$

which are used in [7] to construct the unified Witten–Reshetikhin–Turaev invariants for integral homology spheres. We denote by  $J_{L; \tilde{P}'_1, \dots, \tilde{P}'_n}$  the colored Jones polynomial of  $L$  with  $i$ -th component  $L_i$  colored by  $\tilde{P}'_i$ . Habiro proved that Theorem 1.2 implies the following result.

**Theorem 1.6** [7, Conjecture 8.10] *Let  $L$  be an  $n$ -component boundary link with 0-framing. For  $l \geq 0$ , let  $I_l$  denote the ideal in  $\mathbb{Z}[q, q^{-1}]$  generated by  $\{l - k\}_q! \{k\}_q!$  for  $k = 0, \dots, l$ . For  $l_1, \dots, l_n \geq 0$ , we have*

$$J_{L; \tilde{P}'_1, \dots, \tilde{P}'_n} \in \frac{\{2l_j + 1\}_{q, l_j + 1}}{\{1\}_q} I_{l_1} \cdots \hat{I}_{l_j} \cdots I_{l_n},$$

where  $j$  is an integer such that  $l_j = \max\{l_i\}_{1 \leq i \leq n}$ , and  $\hat{I}_{l_j}$  denotes the omission of  $I_{l_j}$ .

**Remark 1.7** For  $m \geq 1$ , let  $\Phi_m = \prod_{d|m} (q^d - 1)^{\mu(m/d)} \in \mathbb{Z}[q]$  denote the  $m$ -th cyclotomic polynomial, where  $\prod_{d|m}$  denotes the product over all the positive divisors  $d$  of  $m$ , and  $\mu$  is the Möbius function. In [22], we proved that for  $l \geq 0$ , the ideal  $I_l$  is the principal ideal generated by  $\prod_{m \geq 1} \Phi_m^{t_{l,m}}$  with  $t_{l,m} = \max\{0, \lfloor (l + 1)/m \rfloor - 1\}$ , where, for  $r \in \mathbb{Q}$ , we denote by  $\lfloor r \rfloor$  the largest integer smaller than or equal to  $r$ .

Theorem 1.6 is an improvement of the following result in the special case of boundary links.

**Theorem 1.8** (Habiro [7, Theorem 8.2]) *Let  $L$  be an  $n$ -component, algebraically split link with 0-framing. For  $l_1, \dots, l_n \geq 0$ , we have*

$$J_{L; \tilde{P}'_1, \dots, \tilde{P}'_n} \in \frac{\{2l_j + 1\}_{q, l_j + 1}}{\{1\}_q} \mathbb{Z}[q, q^{-1}],$$

where  $j$  is an integer such that  $l_j = \max\{l_i\}_{1 \leq i \leq n}$ .

### 1.3 Examples

Let  $T_B$  be the Borromean bottom tangle depicted in Figure 3(a), whose closure is the Borromean rings. Since we have  $J_{T_B} \notin (\bar{U}_q^{\text{ev}})^{\widehat{\otimes}^3}$  (cf [23]), it follows from Theorems 1.1 and 1.2 that the Borromean rings is neither boundary nor ribbon, as is well known.

More generally, for  $n \geq 3$ , let  $M_n$  be Milnor’s  $n$ -component Brunnian link depicted in Figure 3(b). Note that  $M_3$  is the Borromean rings. Since there is a nontrivial

Milnor  $\bar{\mu}$  invariant of  $M_n$  of length  $n$  (cf [17]),  $M_n$  is neither boundary nor ribbon. We can prove this fact also from Theorem 1.6 and

$$J_{M_n; \tilde{P}'_1, \dots, \tilde{P}'_1} = (-1)^n q^{-2n+4} \Phi_1(q)^{n-2} \Phi_2(q)^{n-2} \Phi_3(q) \Phi_4(q)^{n-3} \notin \Phi_1(q)^n \Phi_2(q) \Phi_3(q) \mathbb{Z}[q, q^{-1}],$$

which we will prove in a forthcoming paper [21].



Figure 3. (a) Borromean rings (b) Milnor’s link  $M_n$

### 1.4 Organization of paper

The rest of the paper is organized as follows. Section 2 contains preliminary results about bottom tangles, the quantized enveloping algebra  $U_h$ , and the universal  $sl_2$  invariant of bottom tangles. In Section 3, we recall from [7] Habiro’s formula for the universal  $sl_2$  invariant of boundary bottom tangles, and then give a modification of his formula. In Sections 4, 5, and 6, we prove Theorem 1.2.

## 2 Preliminaries

In this section, we give preliminary results about bottom tangles, the universal enveloping algebra  $U_h$ , and the universal  $sl_2$  invariant of bottom tangles.

### 2.1 Bottom tangles and boundary bottom tangles

A tangle (cf [10]) is the image of an embedding

$$\left( \coprod^m [0, 1] \right) \sqcup \left( \coprod^n S^1 \right) \hookrightarrow [0, 1]^3,$$

with  $m, n \geq 0$ , whose boundary is on the two lines  $[0, 1] \times \{\frac{1}{2}\} \times \{0, 1\}$  on the bottom and the top of the cube; see Figure 4(a) for example. We equip the image with both an orientation and a framing. Here, at each boundary point, the framing is fixed on the lines  $[0, 1] \times \{\frac{1}{2}\} \times \{0, 1\}$  as in Figure 4(b), where the thin arrows represent the strands of the tangle, and the thick arrows represent the framing.

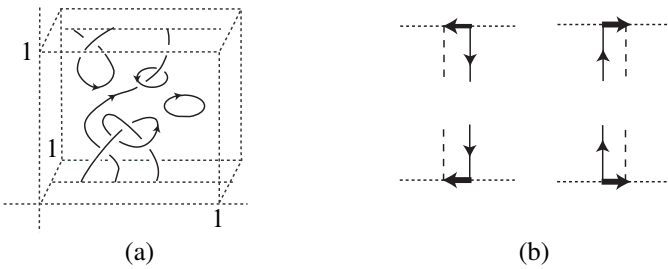

Figure 4. (a) A tangle (b) The framing on the boundary

A *bottom tangle* (cf [5; 7]) is a tangle consisting of arc components such that each boundary point is on the line  $[0, 1] \times \{\frac{1}{2}\} \times \{0\}$  on the bottom, and the two boundary points of each component are adjacent to each other. We give a preferred orientation of the tangle so that each component runs from its right boundary point to its left boundary point. For example, see Figure 5(a), where the dotted lines represent the framing. We draw a diagram of a bottom tangle in a rectangle assuming the blackboard framing; see Figure 5(b).

For each  $n \geq 0$ , let  $BT_n$  denote the set of the ambient isotopy classes, relative to boundary points, of  $n$ -component bottom tangles.

The *closure link*  $cl(T)$  of a bottom tangle  $T$  is defined as the link in  $\mathbb{R}^3$  obtained from  $T$  by closing; see Figure 1 again. For each  $n$ -component link  $L$ , there is an  $n$ -component bottom tangle whose closure is  $L$ . For a bottom tangle, we can define its linking matrix as that of the closure link.

A *Seifert surface* of knot  $K$  is a compact, connected, orientable surface  $F$  in  $\mathbb{R}^3$  bounded by  $K$ . An  $n$ -component link  $L = L_1 \cup \dots \cup L_n$  is called *boundary* if it has  $n$  mutually disjoint Seifert surfaces  $F_1, \dots, F_n$  in  $\mathbb{R}^3$  such that  $L_i$  bounds  $F_i$  for  $i = 1, \dots, n$ .

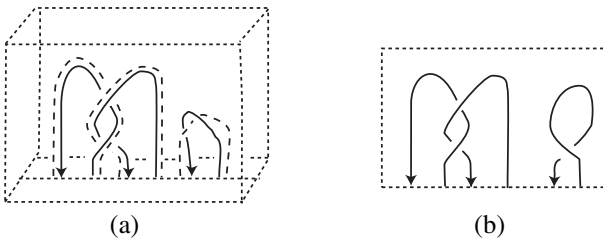

Figure 5. (a) A 3-component bottom tangle  $T$  (b) A diagram of  $T$

For a 1-component bottom tangle  $T \in BT_1$ , there is a knot  $K_T = T \cup \gamma \in [0, 1]^3$ , where  $\gamma$  is the line segment in the bottom  $[0, 1] \times \{\frac{1}{2}\} \times \{0\}$  such that  $\partial\gamma = \partial T$ .

A *Seifert surface* of a 1–component bottom tangle  $T$  is a Seifert surface of the knot  $K_T$  contained in  $[0, 1]^3$ . A bottom tangle  $T = T_1 \cup \dots \cup T_n$  is called *boundary* if it has  $n$  mutually disjoint Seifert surfaces  $F_1, \dots, F_n$  in  $[0, 1]^3$  such that  $K_{T_i}$  bounds  $F_i$  for  $i = 1, \dots, n$ . For example, see [Figure 2](#) again. Obviously, for each boundary link  $L$ , there is a boundary bottom tangle whose closure is  $L$ .

### 2.2 Quantized enveloping algebra $U_h$

We recall the definition of the universal enveloping algebra  $U_h(sl_2)$  of the Lie algebra  $sl_2$ , and its ribbon Hopf algebra structure. We follow the notation of Habiro [\[7\]](#).

We denote by  $U_h = U_h(sl_2)$  the  $h$ –adically complete  $\mathbb{Q}[[h]]$ –algebra, topologically generated by  $H, E, \text{ and } F$ , defined by the relations

$$HE - EH = 2E, \quad HF - FH = -2F, \quad EF - FE = \frac{K - K^{-1}}{q^{1/2} - q^{-1/2}},$$

where we set

$$q = \exp h, \quad K = q^{H/2} = \exp \frac{hH}{2}.$$

We equip  $U_h$  with the topological  $\mathbb{Z}$ –graded algebra structure such that  $\deg E = 1$ ,  $\deg F = -1$ , and  $\deg H = 0$ . For a homogeneous element  $x$  of  $U_h$ , the degree of  $x$  is denoted by  $|x|$ .

There is a complete ribbon Hopf algebra structure on  $U_h$  as follows. The comultiplication  $\Delta: U_h \rightarrow U_h \widehat{\otimes} U_h$ , the counit  $\varepsilon: U_h \rightarrow \mathbb{Q}[[h]]$ , and the antipode  $S: U_h \rightarrow U_h$  are given by

$$\begin{aligned} \Delta(H) &= H \otimes 1 + 1 \otimes H, & \varepsilon(H) &= 0, & S(H) &= -H, \\ \Delta(E) &= E \otimes 1 + K \otimes E, & \varepsilon(E) &= 0, & S(E) &= -K^{-1}E, \\ \Delta(F) &= F \otimes K^{-1} + 1 \otimes F, & \varepsilon(F) &= 0, & S(F) &= -FK. \end{aligned}$$

Set

- (1)  $D = q^{(1/4)H \otimes H} = \exp(\frac{h}{4} H \otimes H) \in U_h^{\widehat{\otimes} 2},$
- (2)  $\tilde{F}^{(n)} = F^n K^n / [n]_q! \in U_h,$
- (3)  $e = (q^{1/2} - q^{-1/2})E \in U_h,$

for  $n \geq 0$ .



The universal  $R$ -matrix and its inverse  $R^{\pm 1} \in U_h \widehat{\otimes} U_h$  are given by

$$R = D \sum_{n \geq 0} q^{(1/2)n(n-1)} \widetilde{F}^{(n)} K^{-n} \otimes e^n,$$

$$R^{-1} = D^{-1} \sum_{n \geq 0} (-1)^n \widetilde{F}^{(n)} \otimes K^{-n} e^n.$$

We have  $R^{\pm 1} = \sum_{n \geq 0} \alpha_n^{\pm} \otimes \beta_n^{\pm}$ , where for  $n \geq 0$ , we set formally

$$\alpha_n \otimes \beta_n (= \alpha_n^+ \otimes \beta_n^+) = D(q^{(1/2)n(n-1)} \widetilde{F}^{(n)} K^{-n} \otimes e^n),$$

$$\alpha_n^- \otimes \beta_n^- = D^{-1}((-1)^n \widetilde{F}^{(n)} \otimes K^{-n} e^n).$$

Note that the right hand sides are infinite sums of tensors of the form as  $x \otimes y$  with  $x, y \in U_h$ . We denote them by  $\alpha_n^{\pm} \otimes \beta_n^{\pm}$  for simplicity.

The ribbon element and its inverse  $r^{\pm 1} \in U_h$  are central elements given by

$$r = \sum_{n \geq 0} \alpha_n^- K^{-1} \beta_n^- = \sum_{n \geq 0} \beta_n^- K \alpha_n^-, \quad r^{-1} = \sum_{n \geq 0} \alpha_n K \beta_n = \sum_{n \geq 0} \beta_n K^{-1} \alpha_n.$$

We use a notation  $D = \sum D' \otimes D''$ . We use the following formulas.

- (4)  $\sum D'' \otimes D' = D,$
- (5)  $(\Delta \otimes 1)D = D_{23} D_{13}, \quad (1 \otimes \Delta)D = D_{13} D_{12},$
- (6)  $(\varepsilon \otimes 1)(D) = 1 = (1 \otimes \varepsilon)(D),$
- (7)  $(1 \otimes S)D = D^{-1} = (S \otimes 1)D,$
- (8)  $D(1 \otimes x) = (K^{|x|} \otimes x)D, \quad D(x \otimes 1) = (x \otimes K^{|x|})D,$

where  $D_{13} = \sum D' \otimes 1 \otimes D'', D_{23} = 1 \otimes D, D_{12} = D \otimes 1,$  and  $x \in U_h$  homogeneous.

### 2.3 Subalgebras of $U_h$

In this section, we recall from [7] the subalgebras  $U_{\mathbb{Z},q}, \bar{U}_q$  and  $\bar{U}_q^{ev}$  of  $U_h$ . Recall from (2) and (3) the definitions of  $\widetilde{F}^{(n)} \in U_h$  and  $e \in U_h$ , respectively. Similarly, set

$$\widetilde{E}^{(n)} = (q^{-1/2} E)^n / [n]_q! \in U_h,$$

$$f = (q - 1)FK \in U_h,$$

for  $n \geq 0$ .

Let  $U_{\mathbb{Z},q}$  denote the  $\mathbb{Z}[q, q^{-1}]$ -subalgebra of  $U_h$  generated by  $K, K^{-1}, \widetilde{E}^{(n)},$  and  $\widetilde{F}^{(n)}$  for  $n \geq 1$ .

Let  $\bar{U}_q$  denote the  $\mathbb{Z}[q, q^{-1}]$ -subalgebra of  $U_{\mathbb{Z},q}$  generated by  $K, K^{-1}, e$  and  $f$ . Let  $\bar{U}_q^{\text{ev}}$  be the  $\mathbb{Z}[q, q^{-1}]$ -subalgebra of  $\bar{U}_q$  generated by  $K^2, K^{-2}, e$  and  $f$ .

**Remark 2.1** For  $i \in \mathbb{Z}, n \geq 0$ , set

$$[i] = \frac{q^{i/2} - q^{-i/2}}{q^{1/2} - q^{-1/2}}, \quad [n]! = [n] \cdots [1].$$

Let  $U_{\mathbb{Z}}$  be the  $\mathbb{Z}[q^{1/2}, q^{-1/2}]$ -subalgebra of  $U_h$  generated by  $K, K^{-1}, E^{(n)} = E^n/[n]!,$  and  $F^{(n)} = F^n/[n]!$  for  $n \geq 1$  (Lusztig’s integral form; cf [15]). We have

$$U_{\mathbb{Z}} = U_{\mathbb{Z},q} \otimes_{\mathbb{Z}[q,q^{-1}]} \mathbb{Z}[q^{1/2}, q^{-1/2}].$$

Let  $\bar{U}$  be the  $\mathbb{Z}[q^{1/2}, q^{-1/2}]$ -subalgebra of  $U_h$  generated by  $K, K^{-1}, (q^{1/2} - q^{-1/2})E$  and  $(q^{1/2} - q^{-1/2})F$  (cf [1]). We have

$$\bar{U} = \bar{U}_q \otimes_{\mathbb{Z}[q,q^{-1}]} \mathbb{Z}[q^{1/2}, q^{-1/2}].$$

There is a Hopf  $\mathbb{Z}[q, q^{-1}]$ -algebra structure on  $U_{\mathbb{Z},q}$  inherited from  $U_h$  (cf [15; 23]). We have

$$(9) \quad \Delta(\tilde{E}^{(m)}) = \sum_{j=0}^m \tilde{E}^{(m-j)} K^j \otimes \tilde{E}^{(j)},$$

$$(10) \quad \Delta(\tilde{F}^{(m)}) = \sum_{j=0}^m \tilde{F}^{(m-j)} K^j \otimes \tilde{F}^{(j)},$$

$$(11) \quad S^{\pm 1}(\tilde{E}^{(m)}) = (-1)^m q^{(1/2)m(m \mp 1)} K^{-m} \tilde{E}^{(m)},$$

$$(12) \quad S^{\pm 1}(\tilde{F}^{(m)}) = (-1)^m q^{-(1/2)m(m \mp 1)} K^{-m} \tilde{F}^{(m)},$$

for  $i \in \mathbb{Z}, m \geq 0$ . Similarly, there is a Hopf  $\mathbb{Z}[q, q^{-1}]$ -algebra structure on  $\bar{U}_q$  inherited from  $U_h$  (cf [1; 7]).

Let  $U_h^0$  denote the Cartan part of  $U_h$ , ie, the subalgebra of  $U_h$  topologically generated by  $H$ . Let  $\bar{U}_q^0$  denote the  $\mathbb{Z}[q, q^{-1}]$ -subalgebra of  $\bar{U}_q$  generated by  $K$  and  $K^{-1}$ . Let  $\bar{U}_q^{\text{ev}0}$  be the  $\mathbb{Z}[q, q^{-1}]$ -subalgebra of  $\bar{U}_q$  generated by  $K^2$  and  $K^{-2}$ . We have

$$\bar{U}_q^0 = \bar{U}_q \cap U_h^0, \quad \bar{U}_q^{\text{ev}0} = \bar{U}_q^{\text{ev}} \cap U_h^0.$$

### 2.4 Adjoint action

In what follows, we use the following notation. For  $m \geq 0$ , let  $\Delta^{[m]}: U_h \rightarrow U_h^{\widehat{\otimes} m}$  denote the  $m$ -output comultiplication defined by  $\Delta^{[0]} = \varepsilon, \Delta^{[1]} = \text{id}_{U_h}$ , and

$$\Delta^{[m]} = (\Delta \otimes \text{id}_{U_h^{\widehat{\otimes} m-2}}) \circ \Delta^{[m-1]},$$

for  $m \geq 2$ . For  $x \in U_h$ ,  $m \geq 1$ , we write

$$\Delta^{[m]}(x) = \sum x_{(1)} \otimes \cdots \otimes x_{(m)}.$$

For  $m_1, \dots, m_l \geq 0$ , set

$$(13) \quad \Delta^{[m_1, \dots, m_l]} = \Delta^{[m_1]} \otimes \cdots \otimes \Delta^{[m_l]}: U_h^{\widehat{\otimes} l} \rightarrow U_h^{\widehat{\otimes} m_1 + \cdots + m_l}.$$

We use the left adjoint action  $\text{ad}: U_h \widehat{\otimes} U_h \rightarrow U_h$  defined by

$$(14) \quad \text{ad}(x \otimes y) = x \triangleright y := \sum x_{(1)} y S(x_{(2)}),$$

for  $x, y \in U_h$ . We use the following proposition.

**Proposition 2.2** [23, Proposition 3.2] For  $i = 0, 1$ , we have

$$U_{\mathbb{Z}, q} \triangleright K^i \bar{U}_q^{\text{ev}} \subset K^i \bar{U}_q^{\text{ev}}.$$

We also use a right action  $\bar{\text{ad}}: U_h \widehat{\otimes} U_h \rightarrow U_h$ , which is the continuous  $\mathbb{Q}[[\hbar]]$ -linear map defined by

$$\begin{aligned} \bar{\text{ad}}(y \otimes x) &= y \triangleleft x := \sum S^{-1}(x_{(2)}) y x_{(1)}, \\ &= \sum S^{-1}(x) \triangleright y. \end{aligned}$$

for  $x, y \in U_h$ . Proposition 2.2 implies the following.

**Corollary 2.3** For  $i = 0, 1$ , we have

$$K^i \bar{U}_q^{\text{ev}} \triangleleft U_{\mathbb{Z}, q} \subset K^i \bar{U}_q^{\text{ev}}.$$

### 2.5 Universal $sl_2$ invariant of bottom tangles

For an  $n$ -component bottom tangle  $T = T_1 \cup \cdots \cup T_n \in BT_n$ , we define the universal  $sl_2$  invariant  $J_T \in U_h^{\widehat{\otimes} n}$  as follows (see Ohtsuki [19] and Habiro [5]).

We choose and fix a diagram of  $T$  obtained from the copies of the fundamental tangles depicted in Figure 6, by pasting horizontally and vertically. We denote by  $C(T)$  the set of the crossings of the diagram. For example, for the bottom tangle  $B$  depicted in Figure 7(a), we can take a diagram with  $C(B) = \{c_1, c_2\}$  as depicted in Figure 7(b). We call a map

$$s: C(T) \rightarrow \{0, 1, 2, \dots\}$$

a *state*. We denote by  $\mathcal{S}(T)$  the set of states of the diagram.



Figure 6. Fundamental tangles, where the orientations of the strands are arbitrary

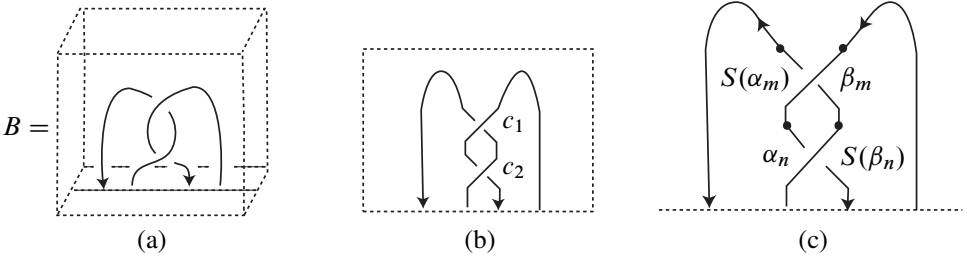

Figure 7. (a) A bottom tangle  $B \in BT_2$  (b) A diagram of  $B$  (c) The labels which are put on the diagram of  $B$

Given a state  $s \in \mathcal{S}(T)$ , we attach labels on the copies of the fundamental tangles in the diagram following the rule described in Figure 8, where “ $S'$ ” should be replaced with  $\text{id}$  if the string is oriented downward, and with  $S$  otherwise. For example, for a state  $t \in \mathcal{S}(B)$ , we put labels on the diagram of  $B$  as in Figure 7(c), where we set  $m = t(c_1)$  and  $n = t(c_2)$ .

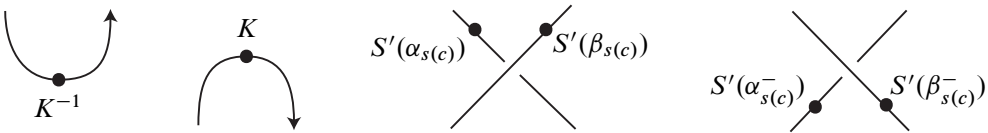

Figure 8. How to place labels on the fundamental tangles

We define an element  $J_{T,s} \in U_h^{\widehat{\otimes} n}$  as follows. The  $i$ -th tensorand of  $J_{T,s}$  is defined to be the product of the labels put on the component corresponding to  $T_i$ , where the labels are read off along  $T_i$  reversing the orientation, and written from left to right. We identify the labels  $S'(\alpha_i^\pm)$  and  $S'(\beta_i^\pm)$  with the first and the second tensorands, respectively, of the element  $S'(\alpha_i^\pm) \otimes S'(\beta_i^\pm) \in U_h^{\widehat{\otimes} 2}$ . Also we identify the label  $K^\pm$  with the element  $K^\pm \in U_h$ . Then,  $J_{T,s}$  is a well-defined element in  $U_h^{\widehat{\otimes} n}$ . For

example, for the state  $t \in \mathcal{S}(B)$  with  $t(c_1) = m$  and  $t(c_2) = n$ , we have

$$\begin{aligned} J_{B,t} &= S(\alpha_m)S(\beta_n) \otimes \alpha_n \beta_m \\ &= \sum q^{(1/2)m(m-1)} q^{(1/2)n(n-1)} S(D'_1 \tilde{F}^{(m)} K^{-m}) S(D''_2 e^n) \otimes D'_2 \tilde{F}^{(n)} K^{-n} D''_1 e^m \\ &= (-1)^{m+n} q^{-n+2mn} D^{-2} (\tilde{F}^{(m)} K^{-2n} e^n \otimes \tilde{F}^{(n)} K^{-2m} e^m) \in U_h^{\widehat{\otimes} 2}, \end{aligned}$$

where  $D = \sum D'_1 \otimes D''_1 = \sum D'_2 \otimes D''_2$ . Note that  $J_{T,s}$  depends on the choice of the diagram.

Set 
$$J_T = \sum_{s \in \mathcal{S}(T)} J_{T,s}.$$

For example, we have

$$J_B = \sum_{t \in \mathcal{S}(B)} J_{B,t} = \sum_{m,n \geq 0} (-1)^{m+n} q^{-n+2mn} D^{-2} (\tilde{F}^{(m)} K^{-2n} e^n \otimes \tilde{F}^{(n)} K^{-2m} e^m).$$

As is well known [19],  $J_T$  does not depend on the choice of the diagram, and defines an isotopy invariant of bottom tangles.

### 3 Universal invariant of boundary bottom tangles

In this section, we recall Habiro’s formulas for boundary bottom tangles at the topological level (Proposition 3.1), and at the algebraic level on the universal  $sl_2$  invariant (Proposition 3.3). Then, we modify these formulas into a form more convenient for our purpose. In the last section, we give an outline of the proof of Theorem 1.2.

In what follows, we use the following notation. Let  $\eta: \mathbb{Q}[[h]] \rightarrow U_h$  be the unit morphism and  $\mu: U_h^{\widehat{\otimes} 2} \rightarrow U_h$  the multiplication of  $U_h$ . For  $g \geq 0$ , let  $\mu^{[g]}: U_h^{\widehat{\otimes} g} \rightarrow U_h$  denote the  $g$ -input multiplication defined by  $\mu^{[0]} = \eta$ ,  $\mu^{[1]} = \text{id}_{U_h}$ , and

$$\mu^{[g]} = \mu^{[g-1]} \circ (\mu \otimes \text{id}_{U_h^{\widehat{\otimes} g-2}}),$$

for  $g \geq 2$ . For  $g_1, \dots, g_n \geq 0$ , set

$$(15) \quad \mu^{[g_1, \dots, g_n]} = \mu^{[g_1]} \otimes \dots \otimes \mu^{[g_n]}: U_h^{\widehat{\otimes} g_1 + \dots + g_n} \rightarrow U_h^{\widehat{\otimes} n}.$$

#### 3.1 Habiro’s formula (topological level)

Let  $T = T_1 \cup \dots \cup T_n \in BT_n$  be a boundary bottom tangle and  $F_1, \dots, F_n$  mutually disjoint Seifert surfaces such that  $\partial F_i = K_{T_i}$  for  $i = 1, \dots, n$ . We can arrange  $T$  with the surfaces  $F_1, \dots, F_n$  as depicted in Figure 9, where the dotted lines in the rectangle represent a tangle  $D(T')$  which may intertwine, while the bottom half is precisely

as depicted. Note that  $D(T')$  is obtained from a bottom tangle  $T' \in BT_{2g}$  by first duplicating each component and then reversing the orientation of the inner component of each pair of duplicated components. Here  $g = g_1 + \dots + g_n$  with  $g_i = \text{genus}(F_i)$ .

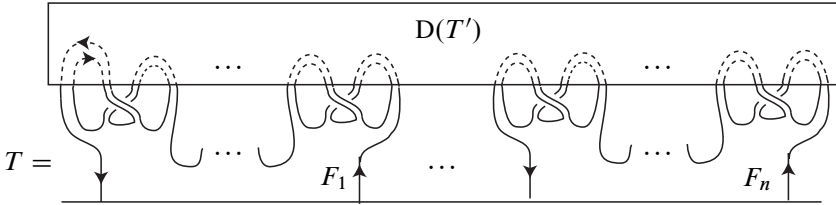

Figure 9. How to arrange Seifert surfaces

Let  $y_b$  be the tangle as depicted in Figure 10(a). For  $U \in BT_{2g}$ ,  $g \geq 0$ , let  $Y_b^{\otimes g}(U)$  be the bottom tangle obtained from  $D(U)$  by gluing  $y_b^{\otimes g}$  to the bottom as depicted in Figure 10(b). Here, as usual, the tensor product of tangles is obtained by placing them side by side.

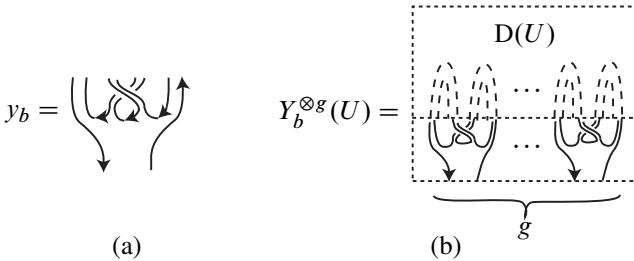

Figure 10. (a)  $y_b$  (b)  $Y_b^{\otimes g}(U) \in BT_g$  for  $U \in BT_{2g}$

For  $g \geq 0$ , let  $\mu_b^{[g]}$  be the tangle as depicted in Figure 11(a). For  $g_1, \dots, g_n \geq 0$ , set

$$\mu_b^{[g_1, \dots, g_n]} = \mu_b^{[g_1]} \otimes \dots \otimes \mu_b^{[g_n]}.$$

For  $V \in BT_{g_1 + \dots + g_n}$ , let  $\mu_b^{[g_1, \dots, g_n]}(V) \in BT_n$  be the bottom tangle obtained from  $V$  by gluing the product  $\mu_b^{[g_1, \dots, g_n]}$  to the bottom as depicted in Figure 11(b).

The above argument implies the following result, which appeared in the proof of [5, Theorem 9.9].

**Proposition 3.1** (Habiro [5]) *For a bottom tangle  $T \in BT_n$ , the following conditions are equivalent.*

- (1)  $T$  is a boundary bottom tangle.
- (2) There is a bottom tangle  $T' \in BT_{2g}$ ,  $g \geq 0$ , and integers  $g_1, \dots, g_n \geq 0$  satisfying  $g_1 + \dots + g_n = g$ , such that

$$(16) \quad T = \mu_b^{[g_1, \dots, g_n]} Y_b^{\otimes g}(T').$$

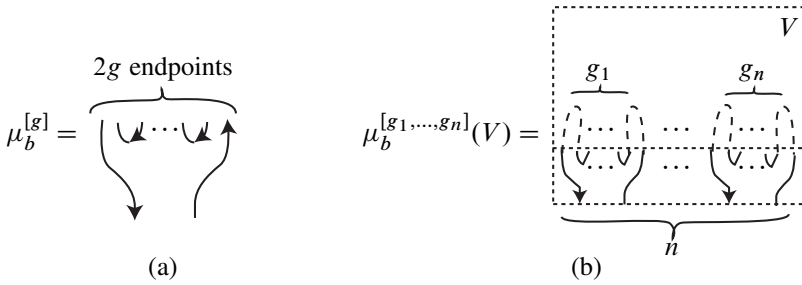

Figure 11. (a)  $\mu_b^{[g]}$  (b)  $\mu_b^{[g_1, \dots, g_n]}(V) \in BT_n$  for  $V \in BT_{g_1 + \dots + g_n}$

### 3.2 Habiro’s formula (algebraic level)

Recall from [5, Proposition 9.7] the commutator morphism  $Y_{\underline{H}}: H \otimes H \rightarrow H$  for a ribbon Hopf algebra  $H$ . In the present case  $H = U_h$ , the morphism  $Y_{\underline{U}_h}: U_h \hat{\otimes} U_h \rightarrow U_h$  is the continuous  $\mathbb{Q}[[h]]$ -linear map defined by

$$Y_{\underline{U}_h}(x \otimes y) = \sum_{k \geq 0} x \triangleright \left( \beta_k S((\alpha_k \triangleright y)_{(1)}) \right) (\alpha_k \triangleright y)_{(2)}$$

for  $x, y \in U_h$ .

**Lemma 3.2** (Habiro [5]) (i) For each bottom tangle  $T \in BT_{2g}$ ,  $g \geq 0$ , we have

$$J_{Y_{\underline{U}_h}^{\otimes g}(T)} = Y_{\underline{U}_h}^{\otimes g}(J_T).$$

(ii) For each bottom tangle  $T \in BT_{g_1 + \dots + g_n}$ ,  $g_1, \dots, g_n \geq 0$ , we have

$$J_{\mu_b^{[g_1, \dots, g_n]}(T)} = \mu^{[g_1, \dots, g_n]}(J_T).$$

Proposition 3.1 and Lemma 3.2 imply the following.

**Proposition 3.3** (Habiro [5]) For a boundary bottom tangle  $T \in BT_n$  and a bottom tangle  $T' \in BT_{2g}$  satisfying (16), we have

$$J_T = \mu^{[g_1, \dots, g_n]}(Y_{\underline{U}_h}^{\otimes g}(J_{T'})).$$

### 3.3 Modification of Habiro’s formula (topological level)

In this section, we modify Proposition 3.1.

We decompose the operator  $Y_b^{\otimes g}: BT_{2g} \rightarrow BT_g$  into the two operators  $\nu_b^{\otimes g}: BT_{2g} \rightarrow \nu_b^{\otimes g}(BT_{2g})$  and  $\bar{Y}_b^{\otimes g}: \nu_b^{\otimes g}(BT_{2g}) \rightarrow BT_g$  as follows.

Let  $v_b$  be the tangle as depicted in Figure 12(a). For  $U \in BT_{2g}$ ,  $g \geq 0$ , let  $\tilde{U} = v_b^{\otimes g}(U)$  be the  $2g$ -component (nonbottom) tangle obtained from  $U$  by gluing  $v_b^{\otimes g}$  to the bottom as depicted in Figure 12(b).

Set  $\bar{Y}_b^{\otimes g}(\tilde{U}) = Y_b^{\otimes g}(U)$ . Note that  $\bar{Y}_b^{\otimes g}(\tilde{U}) = \mu_b^{[4, \dots, 4]}(D(\tilde{U}))$  as depicted in Figure 12(c), where  $D(\tilde{U})$  is defined in a similar way to that for bottom tangles.

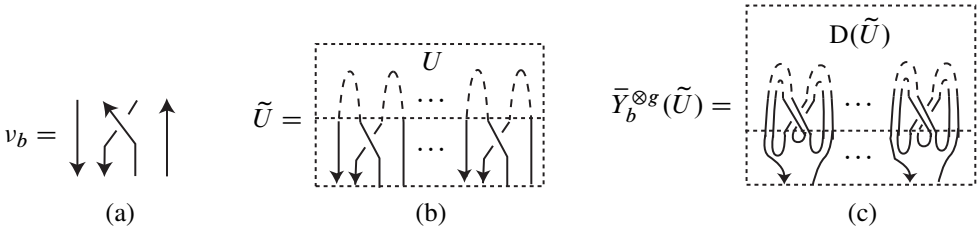

Figure 12. (a)  $v_b$  (b)  $\tilde{U} = v_b^{\otimes g}(U)$  (c)  $\bar{Y}_b^{\otimes g}(\tilde{U}) \in BT_g$

By the definitions, we have  $Y_b^{\otimes g} = \bar{Y}_b^{\otimes g} \circ v_b^{\otimes g}$ . Thus, we can modify Proposition 3.1 by replacing (2) with (2') as follows.

**Proposition 3.4** For a bottom tangle  $T \in BT_n$ , the following conditions are equivalent.

- (1)  $T$  is a boundary bottom tangle.
- (2') There exist a  $2g$ -component tangle  $\tilde{T} \in v_b^{\otimes g}(BT_{2g})$ ,  $g \geq 0$  and integers  $g_1, \dots, g_n \geq 0$  satisfying  $g_1 + \dots + g_n = g$ , such that

$$T = \mu_b^{[g_1, \dots, g_n]} \bar{Y}_b^{\otimes g}(\tilde{T}).$$

For a boundary bottom tangle  $T \in BT_n$ , we call  $(\tilde{T}; g_1, \dots, g_n)$  as in (2') a *boundary data* for  $T$ .

### 3.4 Modification of Habiro’s formula (algebraic level)

In this section, we modify Proposition 3.3.

Let  $\bar{Y}: U_h \hat{\otimes} U_h \rightarrow U_h$  be the continuous  $\mathbb{Q}[[\hbar]]$ -linear map defined by

$$(17) \quad \bar{Y}(x \otimes y) = \sum x_{(1)} KS(y_{(2)}) KS(x_{(2)}) y_{(1)},$$

for  $x, y \in U_h$ .

Note that we can define the universal  $sl_2$  invariant  $J_T \in U_h^{\hat{\otimes} 2g}$  of a tangle  $T$  consisting of arc components in a similar way to that of bottom tangles (cf [5]).



**Proposition 3.5** Let  $T \in BT_n$  be a boundary bottom tangle and  $(\tilde{T}; g_1, \dots, g_n)$  a boundary data for  $T$ . We have

$$J_T = \mu^{[g_1, \dots, g_n]} \bar{Y}^{\otimes g}(J_{\tilde{T}}).$$

**Proof** By Proposition 3.4 and Lemma 3.2(ii), it is enough to prove that

$$J_{\bar{Y}_b^{\otimes g}(\tilde{T})} = \bar{Y}^{\otimes g}(J_{\tilde{T}})$$

for  $\tilde{T} \in \nu_b^{\otimes g}(BT_{2g})$ .

Let  $W = W_1 \cup \dots \cup W_n$  be a tangle which consists of arc components whose boundary points are all on the bottom. For  $i = 1, \dots, n$ , let  $(1^{\otimes i-1} \otimes \Delta_b \otimes 1^{\otimes n-i})(W)$  be the tangle obtained from  $W$  by duplicating  $W_i$ , and  $(1^{\otimes i-1} \otimes S_b \otimes 1^{\otimes n-i})(W)$  the tangle obtained from  $W$  by reversing the orientation of  $W_i$ .

It is well-known that

$$\begin{aligned} J_{(1^{\otimes i-1} \otimes \Delta_b \otimes 1^{\otimes n-i})(W)} &= (1^{\otimes i-1} \otimes \Delta \otimes 1^{\otimes n-i})(J_W), \\ J_{(1^{\otimes i-1} \otimes S_b \otimes 1^{\otimes n-i})(W)} &= (1^{\otimes i-1} \otimes \tilde{S} \otimes 1^{\otimes n-i})(J_W), \end{aligned}$$

where  $\tilde{S}(x) = KS(x)$  for  $x \in U_h$  (cf [5, Section 7.5], where  $\kappa = \sum_{n \geq 0} S(\beta_n) \alpha_n r^{-1} = K^{-1}$  in the present case).

Note that  $D(\tilde{T}) = (1 \otimes S_b)^{\otimes g} \Delta_b^{\otimes 2g}(\tilde{T})$  by the definitions. Thus, if we write  $J_{\tilde{T}} = \sum x_1 \otimes \dots \otimes x_{2g}$ , then we have

$$\begin{aligned} J_{D(\tilde{T})} &= (1 \otimes \tilde{S})^{\otimes g} \Delta^{\otimes 2g}(J_{\tilde{T}}) \\ &= \sum x_{1(1)} \otimes KS(x_{1(2)}) \otimes x_{2(1)} \otimes KS(x_{2(2)}) \otimes \dots \otimes x_{2g(1)} \otimes KS(x_{2g(2)}). \end{aligned}$$

Recall that we obtain  $\bar{Y}_b^{\otimes g}(\tilde{T})$  from  $D(\tilde{T})$  by gluing  $\mu_b^{[4, \dots, 4]}$ . This implies

$$\begin{aligned} J_{\bar{Y}_b^{\otimes g}(\tilde{T})} &= \sum x_{1(1)} KS(x_{2(2)}) KS(x_{1(2)}) x_{2(1)} \otimes \\ &\quad \dots \otimes x_{2g-1(1)} KS(x_{2g(2)}) KS(x_{2g-1(2)}) x_{2g(1)} \\ &= \bar{Y}^{\otimes g}(J_{\tilde{T}}). \end{aligned}$$

See Figure 13 for an example with  $g = 1$ .

Hence we have the assertion. □

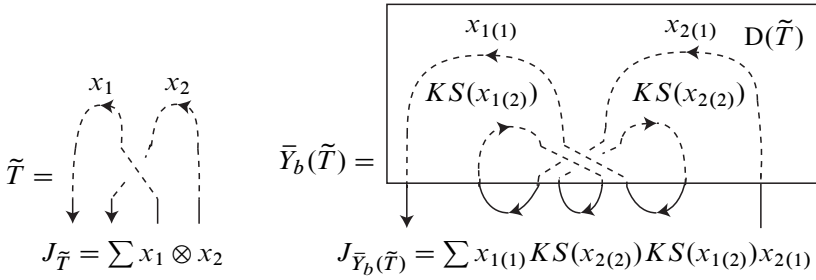

Figure 13.  $\tilde{T} \in BT_2$ ,  $\bar{Y}_b(\tilde{T}) \in BT_1$  and their universal  $sl_2$  invariants

### 3.5 Commutator maps

In this section, we study the commutator map  $\bar{Y}$  of  $U_h$ .

Let  $\dot{Y}: U_h \hat{\otimes} U_h \rightarrow U_h$  be the continuous  $\mathbb{Q}[[h]]$ -linear map defined by

$$\dot{Y}(x \otimes y) = \sum x_{(1)} S^{-1}(y_{(2)}) S(x_{(2)}) y_{(1)},$$

for  $x, y \in U_h$ . Note that

$$(18) \quad \dot{Y}(x \otimes y) = \sum (x \triangleright S^{-1}(y_{(2)})) y_{(1)}$$

$$(19) \quad = \sum x_{(1)} (S(x_{(2)}) \triangleleft y)$$

$$(20) \quad = \sum x_{(1)} (S^{-1}(y) \triangleright S(x_{(2)})).$$

By the following lemma, we can study  $\bar{Y}$  by using  $\dot{Y}$ ,  $\triangleright$  and  $\triangleleft$ .

**Lemma 3.6** For  $x, y \in U_h$ , we have

$$\bar{Y}(x \otimes y) = \sum \dot{Y}(x_{(1)} \otimes y_{(2)}) ((x_{(2)} \triangleright K^2) \triangleleft y_{(1)}).$$

**Proof** We have

$$\begin{aligned} \bar{Y}(x \otimes y) &= \sum x_{(1)} KS(y_{(2)}) KS(x_{(2)}) y_{(1)} \\ &= \sum x_{(1)} S^{-1}(y_{(2)}) K^2 S(x_{(2)}) y_{(1)} \\ &= \sum x_{(1)} S^{-1}(y_{(2)}) S(x_{(2)}) x_{(3)} K^2 S(x_{(4)}) y_{(1)} \\ &= \sum x_{(1)} S^{-1}(y_{(4)}) S(x_{(2)}) y_{(3)} S^{-1}(y_{(2)}) x_{(3)} K^2 S(x_{(4)}) y_{(1)} \\ &= \sum \dot{Y}(x_{(1)} \otimes y_{(2)}) ((x_{(2)} \triangleright K^2) \triangleleft y_{(1)}), \end{aligned}$$

where the second identity follows from  $Kz = S^{-2}(z)K$  for  $z \in U_h$ . □

The rest of this section is devoted to studying the map  $\dot{Y}$ .

**Lemma 3.7** For  $x, y, z \in U_h$ , we have

$$(21) \quad \dot{Y}(xy \otimes z) = \sum (x_{(1)} \triangleright \dot{Y}(y \otimes z_{(2)})) \dot{Y}(x_{(2)} \otimes z_{(1)}),$$

$$(22) \quad \dot{Y}(x \otimes yz) = \sum \dot{Y}(x_{(1)} \otimes z_{(2)}) (\dot{Y}(x_{(2)} \otimes y) \triangleleft z_{(1)}).$$

**Proof** We have

$$\begin{aligned} \dot{Y}(xy \otimes z) &= \sum (xy)_{(1)} S^{-1}(z_{(2)}) S((xy)_{(2)}) z_{(1)} \\ &= \sum x_{(1)} y_{(1)} S^{-1}(z_{(2)}) S(y_{(2)}) S(x_{(2)}) z_{(1)} \\ &= \sum x_{(1)} y_{(1)} S^{-1}(z_{(4)}) S(y_{(2)}) z_{(3)} S^{-1}(z_{(2)}) S(x_{(2)}) z_{(1)} \\ &= \sum x_{(1)} y_{(1)} S^{-1}(z_{(4)}) S(y_{(2)}) z_{(3)} S(x_{(2)}) x_{(3)} S^{-1}(z_{(2)}) S(x_{(4)}) z_{(1)} \\ &= \sum (x_{(1)} \triangleright \dot{Y}(y \otimes z_{(2)})) \dot{Y}(x_{(2)} \otimes z_{(1)}). \end{aligned}$$

Similarly, we have

$$\begin{aligned} \dot{Y}(x \otimes yz) &= \sum x_{(1)} S^{-1}((yz)_{(2)}) S(x_{(2)}) (yz)_{(1)} \\ &= \sum x_{(1)} S^{-1}(z_{(4)}) S(x_{(2)}) z_{(3)} S^{-1}(z_{(2)}) x_{(3)} S^{-1}(y_{(2)}) S(x_{(4)}) y_{(1)} z_{(1)} \\ &= \sum \dot{Y}(x_{(1)} \otimes z_{(2)}) (\dot{Y}(x_{(2)} \otimes y) \triangleleft z_{(1)}). \quad \square \end{aligned}$$

**Lemma 3.8** For  $x, y \in U_h^0$ , we have

$$\dot{Y}(x \otimes y) = \varepsilon(x) \varepsilon(y).$$

**Proof** It is enough to prove

$$\dot{Y}(H^m \otimes H^n) = \delta_{m,0} \delta_{n,0},$$

for  $m, n \geq 0$ . By using the formula

$$\Delta(H^m) = \sum_{i=0}^m \binom{m}{i} H^i \otimes H^{m-i},$$

for  $m \geq 0$ , we have

$$\begin{aligned} \dot{Y}(H^m \otimes H^n) &= \sum_{i=0}^m \sum_{j=0}^n \binom{m}{i} \binom{n}{j} H^i (-H)^j (-H)^{m-i} H^{n-j} \\ &= \left( \sum_{i=0}^m (-1)^i \binom{m}{i} \right) \left( \sum_{j=0}^n (-1)^j \binom{n}{j} \right) (-1)^m H^{n+m} \\ &= \delta_{n,0} \delta_{m,0}. \end{aligned} \quad \square$$

**Lemma 3.9** We have

$$(23) \quad \dot{Y}(U_{\mathbb{Z},q} \otimes \bar{U}_q) \subset \bar{U}_q^{\text{ev}},$$

$$(24) \quad \dot{Y}(\bar{U}_q \otimes U_{\mathbb{Z},q}) \subset \bar{U}_q^{\text{ev}}.$$

**Proof** We prove (23). Then (24) is similar. Note that

$$(25) \quad (1 \otimes S^{\pm 1})\Delta(\bar{U}_q) \subset \bigoplus_{i=0,1} (K^i \bar{U}_q^{\text{ev}} \otimes K^i \bar{U}_q^{\text{ev}}),$$

since we have

$$(26) \quad (1 \otimes S^{\pm 1})\Delta(K^{\pm 1}) = K^{\pm 1} \otimes K^{\mp 1},$$

$$(27) \quad (1 \otimes S^{\pm 1})\Delta(\tilde{F}^{(n)}) = \sum_{j=0}^n (-1)^n q^{-(1/2)n(n \mp 1)} \tilde{F}^{(n-j)} K^j \otimes K^{-j} \tilde{F}^{(j)},$$

$$(28) \quad (1 \otimes S^{\pm 1})\Delta(e) = e \otimes 1 - q^{(1/2)(1 \mp 1)} K \otimes K^{-1} e.$$

Then, (18) and (25) imply

$$\dot{Y}(U_{\mathbb{Z},q} \otimes \bar{U}_q) \subset \sum_{i=0,1} (U_{\mathbb{Z},q} \triangleright K^i \bar{U}_q^{\text{ev}}) K^i \bar{U}_q^{\text{ev}}.$$

By Proposition 2.2, we have

$$\sum_{i=0,1} (U_{\mathbb{Z},q} \triangleright K^i \bar{U}_q^{\text{ev}}) K^i \bar{U}_q^{\text{ev}} \subset \sum_{i=0,1} (K^i \bar{U}_q^{\text{ev}}) \cdot (K^i \bar{U}_q^{\text{ev}}) \subset \bar{U}_q^{\text{ev}}.$$

This completes the proof. □

In what follows, we use the notation  $D^{\pm 1} = \sum D'_{\pm} \otimes \sum D''_{\pm}$ .

**Lemma 3.10** We have

$$(29) \quad \sum \dot{Y}(U_{\mathbb{Z},q} \otimes \bar{U}_q^0 D'_\pm) \otimes \dot{Y}(\bar{U}_q \otimes \bar{U}_q^0 D''_\pm) \subset (\bar{U}_q^{\text{ev}})^{\otimes 2},$$

$$(30) \quad \sum \dot{Y}(U_{\mathbb{Z},q} \otimes \bar{U}_q^0 D'_\pm) \otimes \dot{Y}(\bar{U}_q^0 D''_\pm \otimes \bar{U}_q) \subset (\bar{U}_q^{\text{ev}})^{\otimes 2},$$

$$(31) \quad \sum \dot{Y}(\bar{U}_q^0 D'_\pm \otimes U_{\mathbb{Z},q}) \otimes \dot{Y}(\bar{U}_q \otimes \bar{U}_q^0 D''_\pm) \subset (\bar{U}_q^{\text{ev}})^{\otimes 2},$$

$$(32) \quad \sum \dot{Y}(\bar{U}_q^0 D'_\pm \otimes U_{\mathbb{Z},q}) \otimes \dot{Y}(\bar{U}_q^0 D''_\pm \otimes \bar{U}_q) \subset (\bar{U}_q^{\text{ev}})^{\otimes 2}.$$

**Proof** First, we prove (30) with  $D$ . Let us assume a weaker inclusion

$$(33) \quad \sum \dot{Y}(U_{\mathbb{Z},q} \otimes D') \otimes \dot{Y}(D'' \otimes \bar{U}_q) \subset (\bar{U}_q^{\text{ev}})^{\otimes 2},$$

which we prove later. We have

$$\begin{aligned} & \sum \dot{Y}(U_{\mathbb{Z},q} \otimes \bar{U}_q^0 D') \otimes \dot{Y}(\bar{U}_q^0 D'' \otimes \bar{U}_q) \\ &= \sum \dot{Y}(U_{\mathbb{Z},q} \otimes D' \bar{U}_q^0) \otimes \dot{Y}(\bar{U}_q^0 D'' \otimes \bar{U}_q) \\ &\subset \sum \dot{Y}(U_{\mathbb{Z},q} \otimes \bar{U}_q^0) (\dot{Y}(U_{\mathbb{Z},q} \otimes D') \triangleleft \bar{U}_q^0) \\ (34) \quad & \qquad \qquad \qquad \otimes (\bar{U}_q^0 \triangleright \dot{Y}(D'' \otimes \bar{U}_q)) \dot{Y}(\bar{U}_q^0 \otimes \bar{U}_q) \\ &\subset \sum \dot{Y}(U_{\mathbb{Z},q} \otimes \bar{U}_q^0) (\bar{U}_q^{\text{ev}} \triangleleft \bar{U}_q^0) \otimes (\bar{U}_q^0 \triangleright \bar{U}_q^{\text{ev}}) \dot{Y}(\bar{U}_q^0 \otimes \bar{U}_q) \\ &\subset \sum \dot{Y}(U_{\mathbb{Z},q} \otimes \bar{U}_q^0) \cdot \bar{U}_q^{\text{ev}} \otimes \bar{U}_q^{\text{ev}} \cdot \dot{Y}(\bar{U}_q^0 \otimes \bar{U}_q) \\ &\subset (\bar{U}_q^{\text{ev}})^{\otimes 2}, \end{aligned}$$

where the identity follows from (8), the first inclusion follows from Lemma 3.7,  $\Delta(X) \subset X^{\otimes 2}$ , for  $X = \bar{U}_q, \bar{U}_q^0, U_{\mathbb{Z},q}$ , and the last inclusion follows from Lemma 3.9.

Now, we prove (33). By (5) and (7), we have

$$(1 \otimes S^{-1} \otimes 1 \otimes S)(\Delta \otimes \Delta)(D) = \sum D'_{1,-} D'_1 \otimes D'_2 D'_{2,-} \otimes D''_{2,-} D''_1 \otimes D''_2 D''_{1,-},$$

where  $D = \sum D'_1 \otimes D''_1 = \sum D'_2 \otimes D''_2$  and  $D^{-1} = \sum D'_{1,-} \otimes D''_{1,-} = \sum D'_{2,-} \otimes D''_{2,-}$ .

For  $a \in U_{\mathbb{Z},q}$  and  $b \in \bar{U}_q$  homogeneous, we have

$$\begin{aligned}
 & \sum \dot{Y}(a \otimes D') \otimes \dot{Y}(D'' \otimes b) \\
 &= \sum a_{(1)} D'_2 D'_{2,-} S(a_{(2)}) D'_{1,-} D'_1 \otimes D''_{2,-} D''_1 S^{-1}(b_{(2)}) D''_2 D''_{1,-} b_{(1)} \\
 (35) \quad &= \sum a_{(1)} D'_2 D'_{2,-} K^{-|b_{(2)}|} S(a_{(2)}) K^{|b_{(2)}|} D'_{1,-} D'_1 \\
 & \quad \otimes S^{-1}(b_{(2)}) D''_{2,-} D''_1 D''_2 D''_{1,-} b_{(1)} \\
 &= \sum a_{(1)} K^{-|b_{(2)}|} S(a_{(2)}) K^{|b_{(2)}|} \otimes S^{-1}(b_{(2)}) b_{(1)} \\
 &= \sum (a \triangleright K^{-|b_{(2)}|}) K^{|b_{(2)}|} \otimes S^{-1}(b_{(2)}) b_{(1)},
 \end{aligned}$$

where by (26)–(28), we can assume that  $S^{-1}(b_{(2)})b_{(1)} \in \bar{U}_q^{ev}$ , with  $b_{(1)}, b_{(2)} \in \bar{U}_q$  homogeneous. By Corollary 2.3, we have  $a \triangleright K^{-|b_{(2)}|} \in K^{|b_{(2)}|} \bar{U}_q^{ev}$ . Hence we have

$$\sum (a \triangleright K^{-|b_{(2)}|}) K^{|b_{(2)}|} \otimes S^{-1}(b_{(2)}) b_{(1)} \subset (K^{|b_{(2)}|} \bar{U}_q^{ev}) K^{|b_{(2)}|} \otimes \bar{U}_q^{ev} \subset (\bar{U}_q^{ev})^{\otimes 2},$$

which completes the proof of (33).

We can prove (29), (30) with  $D^{-1}$ , (31), and (32) almost in the same way by using

$$\begin{aligned}
 \sum \dot{Y}(a \otimes D'_\pm) \otimes \dot{Y}(b \otimes D''_\pm) &= \sum (a \triangleright K^{\pm|b_{(2)}|}) K^{\mp|b_{(2)}|} \otimes b_{(1)} S(b_{(2)}), \\
 \sum \dot{Y}(a \otimes D'_-) \otimes \dot{Y}(D''_- \otimes b) &= \sum (a \triangleright K^{|b_{(2)}|}) K^{-|b_{(2)}|} \otimes S^{-1}(b_{(2)}) b_{(1)}, \\
 \sum \dot{Y}(D'_\pm \otimes a) \otimes \dot{Y}(b \otimes D''_\pm) &= \sum K^{\mp|b_{(2)}|} (K^{\pm|b_{(2)}|} \triangleleft a) \otimes b_{(1)} S(b_{(2)}), \\
 \sum \dot{Y}(D'_\pm \otimes a) \otimes \dot{Y}(D''_\pm \otimes b) &= \sum K^{\pm|b_{(2)}|} (K^{\mp|b_{(2)}|} \triangleleft a) \otimes S^{-1}(b_{(2)}) b_{(1)},
 \end{aligned}$$

for  $a \in U_{\mathbb{Z},q}$  and  $b \in \bar{U}_q$  homogeneous. □

### 3.6 Outline of the proof of Theorem 1.2

We give an outline of the proof of Theorem 1.2. There are two steps.

The first step is in Section 5, where we prove the following proposition.

**Proposition 3.11** *Let  $T \in BT_n$  be a boundary bottom tangle and  $(\tilde{T}; g_1, \dots, g_n)$  a boundary data for  $T$ . For each state  $s \in S(\tilde{T})$  we have*

$$\mu^{[g_1, \dots, g_n]} \bar{Y}^{\otimes g} (J_{\tilde{T},s}) \in (\bar{U}_q^{ev})^{\otimes n}.$$

The second step is in Section 6, where we define a completion  $(\bar{U}_q^{ev})^{\widehat{\otimes} n}$  of  $(\bar{U}_q^{ev})^{\otimes n}$  and prove Theorem 1.2, ie,

$$J_T = \sum_{s \in \mathcal{S}(\tilde{T})} \mu^{[g_1, \dots, g_n]} \bar{Y}^{\otimes g} (J_{\tilde{T}, s}) \in (\bar{U}_q^{ev})^{\widehat{\otimes} n}.$$

In the above two steps, we use “graphical calculus” because the proof is too complicated to be written down by using expressions. In order to do so, in Section 4, we define two symmetric monoidal categories  $\mathcal{A}$ ,  $\mathcal{M}$ , and a functor  $\mathcal{F}: \mathcal{A} \rightarrow \mathcal{M}$ .

## 4 The categories $\mathcal{M}$ , $\mathcal{A}$ and the functor $\mathcal{F}: \mathcal{A} \rightarrow \mathcal{M}$

In what follows, we use strict symmetric monoidal categories and strict symmetric monoidal functors. Since we use only strict ones, we omit the word “strict”. For the definition of symmetric monoidal categories, see for example, Kassel [10] and Mac Lane [16].

### 4.1 The category $\mathcal{M}$

We define the symmetric monoidal category  $\mathcal{M}$ . The objects in  $\mathcal{M}$  are nonnegative integers. For  $k, l \geq 0$ , the morphisms from  $k$  to  $l$  in  $\mathcal{M}$  are  $\mathbb{Z}[q, q^{-1}]$ -submodules of the  $\mathbb{Q}[[\hbar]]$ -module  $\text{Hom}_{\mathbb{Q}[[\hbar]]}^{\text{cts}}(U_h^{\widehat{\otimes} k}, U_h^{\widehat{\otimes} l})$  of continuous  $\mathbb{Q}[[\hbar]]$ -linear maps from  $U_h^{\widehat{\otimes} k}$  to  $U_h^{\widehat{\otimes} l}$ .

We equip  $\mathcal{M}$  with a symmetric monoidal category structure as follows.

- The identity of an object  $k$  in  $\mathcal{M}$  is defined by  $\text{id}_k = \mathbb{Z}[q, q^{-1}] \text{id}_{U_h^{\widehat{\otimes} k}}$ .  
The composition of morphisms

$$k \xrightarrow{X} l \xrightarrow{Y} m$$

in  $\mathcal{M}$  is defined by

$$Y \circ X = \text{Span}_{\mathbb{Z}[q, q^{-1}]} \{y \circ x \mid x \in X, y \in Y\}.$$

- The unit object is 0, and the tensor product of objects  $k$  and  $l$  in  $\mathcal{M}$  is defined by  $k + l$ .

The tensor product of morphisms  $Z: k \rightarrow l$  and  $Z': k' \rightarrow l'$  in  $\mathcal{M}$  is defined by

$$Z \otimes Z' = \text{Span}_{\mathbb{Z}[q, q^{-1}]} \{\varphi(z \otimes z') \mid z \in Z, z' \in Z'\},$$

where  $\varphi$  is the natural  $\mathbb{Q}[[\hbar]]$ -linear map

$$\varphi: \text{Hom}_{\mathbb{Q}[[\hbar]]}^{\text{cts}}(U_h^{\widehat{\otimes} k}, U_h^{\widehat{\otimes} l}) \otimes \text{Hom}_{\mathbb{Q}[[\hbar]]}^{\text{cts}}(U_h^{\widehat{\otimes} k'}, U_h^{\widehat{\otimes} l'}) \rightarrow \text{Hom}_{\mathbb{Q}[[\hbar]]}^{\text{cts}}(U_h^{\widehat{\otimes} k+k'}, U_h^{\widehat{\otimes} l+l'}).$$

- The symmetry  $c_{k,l}: k \otimes l \rightarrow l \otimes k$  of objects  $k$  and  $l$  in  $\mathcal{M}$  is defined by

$$c_{k,l} = \mathbb{Z}[q, q^{-1}] \tau_{U_h^{\widehat{\otimes} k}, U_h^{\widehat{\otimes} l}},$$

where  $\tau_{U_h^{\widehat{\otimes} k}, U_h^{\widehat{\otimes} l}}: U_h^{\widehat{\otimes} k+l} \rightarrow U_h^{\widehat{\otimes} l+k}$  is the continuous  $\mathbb{Q}[[\hbar]]$ -linear map defined by

$$\tau_{U_h^{\widehat{\otimes} k}, U_h^{\widehat{\otimes} l}}(x \otimes y) = y \otimes x$$

for  $x \in U_h^{\widehat{\otimes} k}$  and  $y \in U_h^{\widehat{\otimes} l}$ .

It is straightforward to check the axioms of a symmetric monoidal category.

### 4.2 The category $\mathcal{A}$ and the functor $\mathcal{F}: \mathcal{A} \rightarrow \mathcal{M}$

Let  $\mathcal{A}$  be the symmetric monoidal category with the unit object  $I$ , freely generated by an object  $A$  and morphisms

$$\begin{aligned} \langle \{i\}_q! \rangle &\in \text{Hom}_{\mathcal{A}}(I, I), \\ \langle \eta \rangle, \langle \widetilde{E}^{(i)} \rangle, \langle \widetilde{F}^{(i)} \rangle, \langle \overline{U}_q^0 \rangle, \langle \overline{U}_q^{\text{ev}0} \rangle &\in \text{Hom}_{\mathcal{A}}(I, A), \\ \langle D^{\pm 1} \rangle &\in \text{Hom}_{\mathcal{A}}(I, A^{\otimes 2}), \\ \langle \varepsilon \rangle &\in \text{Hom}_{\mathcal{A}}(A, I), \\ \langle \Delta \rangle &\in \text{Hom}_{\mathcal{A}}(A, A^{\otimes 2}), \\ \langle \mu \rangle, \langle \dot{Y} \rangle, \langle \text{ad} \rangle, \langle \overline{\text{ad}} \rangle &\in \text{Hom}_{\mathcal{A}}(A^{\otimes 2}, A), \end{aligned}$$

for  $i \geq 0$ . (Here  $\langle D^{\pm 1} \rangle$  is one morphism, not two morphisms  $\langle D^{+1} \rangle$  and  $\langle D^{-1} \rangle$ .) We denote by  $c_{X,Y}: X \otimes Y \rightarrow Y \otimes X$  the symmetry of objects  $X, Y$  in  $\mathcal{A}$ .

We define the symmetric monoidal subcategories  $\mathcal{A}_{\mathfrak{S}}, \mathcal{A}_{\mu}, \mathcal{A}_{\Delta}$ , and  $\mathcal{A}_{\mu, \Delta}$  of  $\mathcal{A}$  as follows. On objects, we define  $\text{Ob}(\mathcal{A}_{\mathfrak{S}}) = \text{Ob}(\mathcal{A}_{\mu}) = \text{Ob}(\mathcal{A}_{\Delta}) = \text{Ob}(\mathcal{A}_{\mu, \Delta}) = \text{Ob}(\mathcal{A})$ . On morphisms,  $\mathcal{A}_{\mathfrak{S}}$  is generated by no morphism as a symmetric monoidal category, ie, for  $k, l \geq 0, k \neq l$ , we have  $\text{Hom}_{\mathcal{A}_{\mathfrak{S}}}(A^{\otimes k}, A^{\otimes l}) = \emptyset$ , and for  $l \geq 0$ , the monoid  $\text{Hom}_{\mathcal{A}_{\mathfrak{S}}}(A^{\otimes l}, A^{\otimes l})$  is isomorphic to the symmetric group  $\mathfrak{S}(l)$  in a natural way. On morphisms,  $\mathcal{A}_{\mu}$  is generated by  $\langle \mu \rangle$ ,  $\mathcal{A}_{\Delta}$  is generated by  $\langle \Delta \rangle$ , and  $\mathcal{A}_{\mu, \Delta}$  is generated by  $\langle \mu \rangle$  and  $\langle \Delta \rangle$ , as symmetric monoidal categories.

Let  $\mathcal{F}: \mathcal{A} \rightarrow \mathcal{M}$  be the symmetric monoidal functor defined by  $\mathcal{F}(A) = 1$  on objects and

$$\begin{aligned} \mathcal{F}(\langle \{i\}_q! \rangle) &= \mathbb{Z}[q, q^{-1}] \{i\}_q!, \\ \mathcal{F}(\langle \eta \rangle) &= \mathbb{Z}[q, q^{-1}] \eta, \end{aligned}$$



$$\begin{aligned}
 \mathcal{F}(\langle \varepsilon \rangle) &= \mathbb{Z}[q, q^{-1}]\varepsilon, \\
 \mathcal{F}(\langle \mu \rangle) &= \mathbb{Z}[q, q^{-1}]\mu, \\
 \mathcal{F}(\langle \Delta \rangle) &= \mathbb{Z}[q, q^{-1}]\Delta, \\
 \mathcal{F}(\langle \dot{Y} \rangle) &= \mathbb{Z}[q, q^{-1}]\dot{Y}, \\
 \mathcal{F}(\langle \text{ad} \rangle) &= \mathbb{Z}[q, q^{-1}]\text{ad}, \\
 \mathcal{F}(\langle \overline{\text{ad}} \rangle) &= \mathbb{Z}[q, q^{-1}]\overline{\text{ad}}, \\
 \mathcal{F}(\langle \tilde{E}^{(i)} \rangle) &= \bar{U}_q^0 \tilde{E}^{(i)}, \\
 \mathcal{F}(\langle \tilde{F}^{(i)} \rangle) &= \bar{U}_q^0 \tilde{F}^{(i)}, \\
 \mathcal{F}(\langle \bar{U}_q^0 \rangle) &= \bar{U}_q^0, \\
 \mathcal{F}(\langle \bar{U}_q^{\text{ev}0} \rangle) &= \bar{U}_q^{\text{ev}0}, \\
 \mathcal{F}(\langle D^{\pm 1} \rangle) &= (\bar{U}_q^0)^{\otimes 2} D + (\bar{U}_q^0)^{\otimes 2} D^{-1},
 \end{aligned}$$

for  $i \geq 0$ , on morphisms. Here, for a  $\mathbb{Z}[q, q^{-1}]$ -submodule  $X \subset U_h^{\widehat{\otimes} n}$ , we identify  $X$  with a  $\mathbb{Z}[q, q^{-1}]$ -submodule of  $\text{Hom}_{\mathbb{Q}[[h]]}^{\text{cts}}(\mathbb{Q}[[h]], U_h^{\widehat{\otimes} n})$  by identifying  $x \in X$  with the map  $f_x: \mathbb{Q}[[h]] \rightarrow U_h^{\widehat{\otimes} n}$  such that  $f_x(a) = ax$  for  $a \in \mathbb{Q}[[h]]$ .

In what follows, we use diagrams of morphisms in  $\mathcal{A}$  as follows. The generating morphisms in  $\mathcal{A}$  are depicted as in Figure 14. The composition  $y \circ x$  of morphisms  $x$  and  $y$  in  $\mathcal{A}$  is represented as the diagram obtained by placing the diagram of  $x$  on the top of the diagram of  $y$ ; see Figure 15(a). The tensor product  $z \otimes z'$  of morphisms  $z$  and  $z'$  in  $\mathcal{A}$  is represented as the diagram obtained by placing the diagram of  $z'$  to the right of the diagram of  $z$ ; see Figure 15(b).

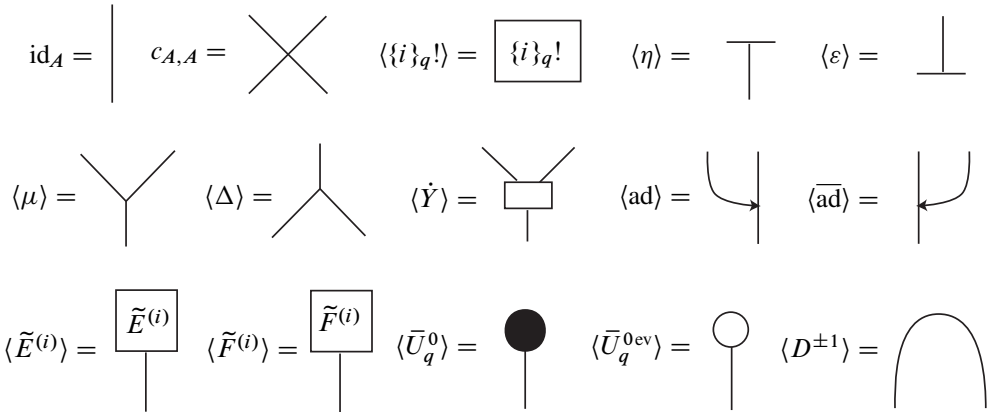

Figure 14. The diagrams of the generator morphisms in  $\mathcal{A}$

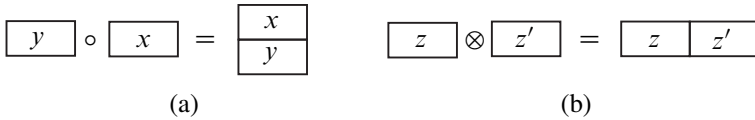

Figure 15. (a) Composition (b) Tensor product

For a diagram of a morphism  $b: A^{\otimes k} \rightarrow A^{\otimes l}$  in  $\mathcal{A}$ , we call the  $k$  edges at the top of the diagram the *input edges* of  $b$ , and the  $l$  edges at the bottom of the diagram the *output edges* of  $b$ .

For simplicity, a copy of a generating morphism  $f$  of  $\mathcal{A}$  appearing in a diagram will be called “an  $f$ ” in the diagram.

### 4.3 Some morphisms in $\mathcal{A}$

In this section, we define morphisms  $\langle \mu \rangle^{[g_1, \dots, g_n]}$ ,  $\langle \Delta \rangle^{[m_1, \dots, m_l]}$ ,  $\langle \alpha_i^\pm \otimes \beta_i^\pm \rangle$ , and  $\langle \bar{Y} \rangle$  in  $\mathcal{A}$ .

For  $g_1, \dots, g_n \geq 0$ , we define

$$\langle \mu \rangle^{[g_1, \dots, g_n]} \in \text{Hom}_{\mathcal{A}}(A^{\otimes g_1 + \dots + g_n}, A^{\otimes n})$$

in a similar way to (15), and for  $m_1, \dots, m_l \geq 0$ , we define

$$\langle \Delta \rangle^{[m_1, \dots, m_l]} \in \text{Hom}_{\mathcal{A}}(A^{\otimes l}, A^{\otimes m_1 + \dots + m_l})$$

in a similar way to (13); see Figure 16. Clearly we have

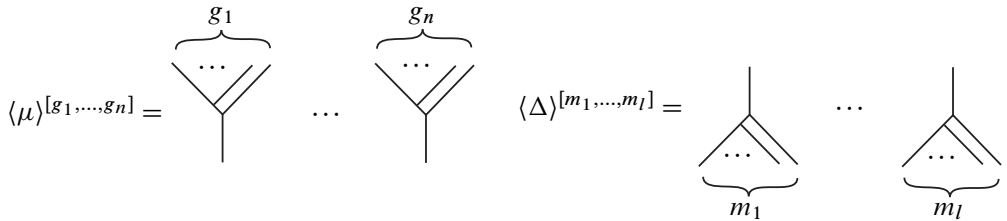

Figure 16. Diagrams of  $\langle \mu \rangle^{[g_1, \dots, g_n]}$  and  $\langle \Delta \rangle^{[m_1, \dots, m_l]}$

$$(36) \quad \mathcal{F}(\langle \mu \rangle^{[g_1, \dots, g_n]}) = \mathbb{Z}[q, q^{-1}] \mu^{[g_1, \dots, g_n]},$$

$$(37) \quad \mathcal{F}(\langle \Delta \rangle^{[m_1, \dots, m_l]}) = \mathbb{Z}[q, q^{-1}] \Delta^{[m_1, \dots, m_l]}.$$

For  $i \geq 0$ , set

$$\langle \Theta_i \rangle = \langle \{i\}_q! \rangle \otimes \langle \tilde{F}^{(i)} \rangle \otimes \langle \tilde{E}^{(i)} \rangle \in \text{Hom}_{\mathcal{A}}(I, A^{\otimes 2}).$$

We depict  $\langle \Theta_i \rangle$  as in Figure 17(a). We define

$$\langle \alpha_i^\pm \otimes \beta_i^\pm \rangle \in \text{Hom}_{\mathcal{A}}(I, A^{\otimes 2})$$

as in Figure 17(b), ie,

$$\langle \alpha_i^\pm \otimes \beta_i^\pm \rangle = (\langle \mu \rangle \otimes \langle \mu \rangle) \circ (\text{id}_A \otimes c_{A,A} \otimes \text{id}_A) \circ (\langle D^{\pm 1} \rangle \otimes \langle \Theta_i \rangle).$$

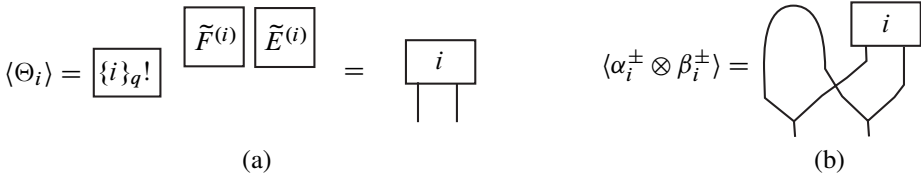

Figure 17. (a) A diagram of  $\langle \Theta_i \rangle$  (b) A diagram of  $\langle \alpha_i^\pm \otimes \beta_i^\pm \rangle$

In  $U_h^{\otimes 2}$ , we have

$$\mathcal{F}(\langle \alpha_i^\pm \otimes \beta_i^\pm \rangle)(1) = (\bar{U}_q^0 \otimes \bar{U}_q^0) D(\tilde{F}^{(i)} \otimes e^i) + (\bar{U}_q^0 \otimes \bar{U}_q^0) D^{-1}(\tilde{E}^{(i)} \otimes e^i),$$

which implies

$$\alpha_i \otimes \beta_i, \alpha_i^- \otimes \beta_i^- \in \mathcal{F}(\langle \alpha_i^\pm \otimes \beta_i^\pm \rangle)(1).$$

For  $j, k \in \mathbb{Z}$ , since we have

$$(S^j \otimes S^k)(\mathcal{F}(\langle \alpha_i^\pm \otimes \beta_i^\pm \rangle)(1)) = \mathcal{F}(\langle \alpha_i^\pm \otimes \beta_i^\pm \rangle)(1),$$

it follows that

$$(38) \quad S^j(\alpha_i) \otimes S^k(\beta_i), S^j(\alpha_i^-) \otimes S^k(\beta_i^-) \in \mathcal{F}(\langle \alpha_i^\pm \otimes \beta_i^\pm \rangle)(1).$$

We define

$$\langle \bar{Y} \rangle \in \text{Hom}_{\mathcal{A}}(A^{\otimes 2}, A^{\otimes 1})$$

as in Figure 18, ie,

$$\langle \bar{Y} \rangle = \langle \mu \rangle \circ (\text{id}_A \otimes \langle \bar{\text{ad}} \rangle) \circ (\text{id}_A \otimes \langle \text{ad} \rangle \otimes \text{id}_A) \circ (\langle \dot{Y} \rangle \otimes \text{id}_A \otimes \langle \bar{U}_q^{\text{ev}0} \rangle \otimes \text{id}_A) \circ (\text{id} \otimes c_{A^{\otimes 2}, A}) \circ (\langle \Delta \rangle \otimes \langle \Delta \rangle).$$

By Lemma 3.6, we have

$$\bar{Y} = \mu \circ (\text{id}_{U_h} \otimes \langle \bar{\text{ad}} \rangle) \circ (\text{id}_{U_h} \otimes \text{ad} \otimes \text{id}_{U_h}) \circ (\langle \dot{Y} \rangle \otimes \text{id}_{U_h} \otimes k^2 \otimes \text{id}_{U_h}) \circ (\text{id}_{U_h} \otimes \tau_{U_h^{\otimes 2}, U_h}) \circ (\Delta \otimes \Delta),$$

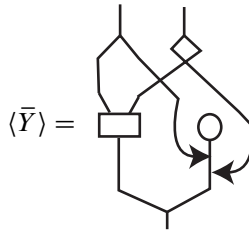

Figure 18. A diagram of  $\langle \bar{Y} \rangle$

where  $k^2$  denotes the operator of the multiplication by  $K^2$ . Hence we have

$$(39) \quad \bar{Y} \in \mathcal{F}(\langle \bar{Y} \rangle).$$

### 5 Proof of Proposition 3.11

The goal of this section is to prove Proposition 3.11. For a subset  $X \subset \text{Hom}_{\mathcal{A}}(I, A^{\otimes g})$ , set

$$\mathcal{F}(X)(1) = \bigcup_{B \in X} \mathcal{F}(B)(1) \subset U_h^{\hat{\otimes} g}.$$

In Section 5.1, we define a subset  $\Gamma_g \subset \text{Hom}_{\mathcal{A}}(I, A^{\otimes g})$ , and prove  $\bar{Y}^{\otimes g}(J_{\tilde{T},s}) \in \mathcal{F}(\Gamma_g)(1)$ . In Sections 5.2–5.8, we prove  $\mathcal{F}(\Gamma_g)(1) \subset (\bar{U}_q^{\text{ev}})^{\otimes g}$ . Thus we have

$$\bar{Y}^{\otimes g}(J_{\tilde{T},s}) \in (\bar{U}_q^{\text{ev}})^{\otimes g},$$

which implies Proposition 3.11.

#### 5.1 The set $\Gamma_g \subset \text{Hom}_{\mathcal{A}}(I, A^{\otimes g})$

Let  $\mathcal{W}$  be the symmetric monoidal category freely generated by two objects  $W_+$  and  $W_-$  and three morphisms

$$\mu_{\mathcal{W}}: (W_+)^{\otimes 2} \rightarrow W_+, \quad \text{ad}_{\mathcal{W}}: W_- \otimes W_+ \rightarrow W_+, \quad \overline{\text{ad}}_{\mathcal{W}}: W_+ \otimes W_- \rightarrow W_+.$$

See Figure 19 for example. We define the symmetric monoidal functor  $\mathcal{F}_{\mathcal{W}}: \mathcal{W} \rightarrow \mathcal{A}$  by  $\mathcal{F}_{\mathcal{W}}(W_+) = \mathcal{F}_{\mathcal{W}}(W_-) = A$  on objects, and

$$\mathcal{F}_{\mathcal{W}}(\mu_{\mathcal{W}}) = \langle \mu \rangle, \quad \mathcal{F}_{\mathcal{W}}(\text{ad}_{\mathcal{W}}) = \langle \text{ad} \rangle, \quad \mathcal{F}_{\mathcal{W}}(\overline{\text{ad}}_{\mathcal{W}}) = \langle \overline{\text{ad}} \rangle,$$

on morphisms.

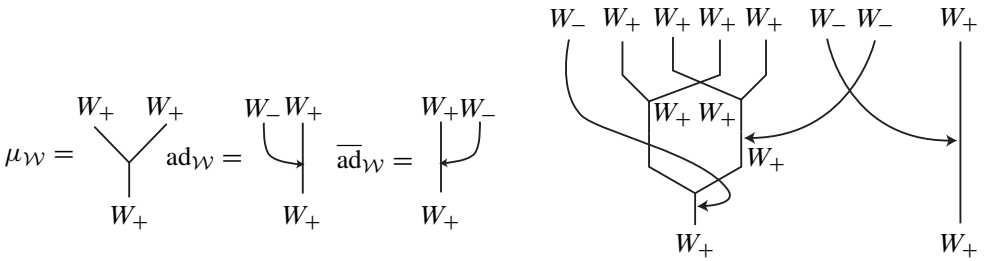

Figure 19. A morphism in  $\mathcal{W}$

For  $g \geq 0$ , let  $\tilde{\Gamma}_g$  be the set of quadruples  $b = (b_1, b_2, b_3, b_4) \in \text{Hom}(\mathcal{A})^{\times 4}$  of composable morphisms

$$I \xrightarrow{b_1} A^{\otimes 2l_1+2l_2+l_3} \xrightarrow{b_2} A^{\otimes l_4+2l_5} \xrightarrow{b_3} A^{\otimes l_4+l_5+l_6} \xrightarrow{b_4} A^{\otimes g}$$

in  $\mathcal{A}$  such that

$$\begin{aligned} b_1 &= \langle D^{\pm 1} \rangle^{\otimes l_1} \otimes \langle \Theta_{s_1} \rangle \otimes \cdots \otimes \langle \Theta_{s_{l_2}} \rangle \otimes \langle \bar{U}_q^0 \rangle^{\otimes l_3}, \\ b_2 &\in \text{Hom}_{\mathcal{A}_{\mu, \Delta}}(A^{\otimes 2l_1+2l_2+l_3}, A^{\otimes l_4+2l_5}), \\ b_3 &= \text{id}_A^{\otimes l_4} \otimes \langle \dot{Y} \rangle^{\otimes l_5} \otimes \langle \bar{U}_q^{\text{ev}0} \rangle^{\otimes l_6}, \\ b_4 &\in \mathcal{F}_{\mathcal{W}}(\text{Hom}_{\mathcal{W}}(W_-^{\otimes l_4} \otimes W_+^{\otimes l_5+l_6}, W_+^{\otimes g})), \end{aligned}$$

for  $l_1, \dots, l_6, s_1, \dots, s_{l_2} \geq 0$ , satisfying **Condition A** below.

**Condition A** On a diagram of  $b_4 \circ b_3 \circ b_2 \circ b_1$ , from each output edge of  $\langle \Theta_{s_p} \rangle$  for  $p = 1, \dots, l_2$ , we can find a descending path to an input edge of a  $\langle \dot{Y} \rangle$ .

For example, see **Figure 20**, where the dotted arrow denotes a path as in **Condition A** from the right output edge of  $\langle \Theta_{s_1} \rangle$ .

Let  $\lambda: \tilde{\Gamma}_g \rightarrow \text{Hom}_{\mathcal{A}}(I, A^{\otimes g})$  be the composition map defined by

$$\lambda(b_1, b_2, b_3, b_4) = b_4 \circ b_3 \circ b_2 \circ b_1.$$

Set  $\Gamma_g = \lambda(\tilde{\Gamma}_g) \subset \text{Hom}_{\mathcal{A}}(I, A^{\otimes g})$ .

We consider the sequence of maps

$$\tilde{\Gamma}_g \xrightarrow{\lambda} \Gamma_g \subset \text{Hom}_{\mathcal{A}}(I, A^{\otimes g}) \xrightarrow{\mathcal{F}} \text{Hom}_{\mathcal{M}}(0, g).$$

**Lemma 5.1** Let  $T \in BT_n$  be a boundary bottom tangle and  $(\tilde{T}; g_1, \dots, g_n)$  a boundary data for  $T$ . For each state  $s \in \mathcal{S}(\tilde{T})$ , we have  $\bar{Y}^{\otimes g}(J_{\tilde{T}, s}) \in \mathcal{F}(\Gamma_g)(1)$ .

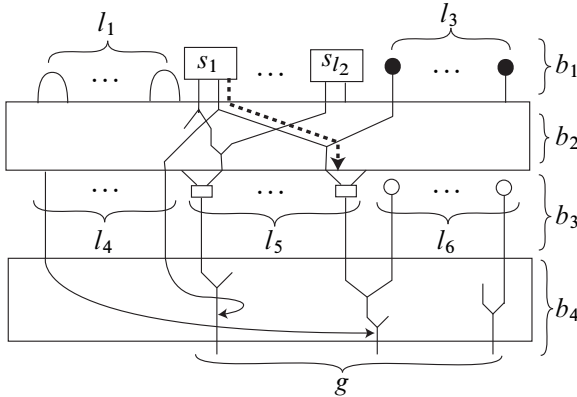

Figure 20. An example of  $b_4 \circ b_3 \circ b_2 \circ b_1$  with  $(b_1, b_2, b_3, b_4) \in \tilde{\Gamma}_g$

**Proof** It is enough to construct an element  $B \in \Gamma_g$  such that  $\bar{Y}^{\otimes g}(J_{\tilde{T},s}) \in \mathcal{F}(B)(1)$ .

Recall from Section 2.5 the definition of  $J_{\tilde{T},s}$  associated with a fixed diagram of  $\tilde{T}$  with the crossings  $c_1, \dots, c_l$ . We put the labels  $S'(\alpha_{s(c_i)}^\pm)$  and  $S'(\beta_{s(c_i)}^\pm)$  on the crossing  $c_i$  for  $i = 1, \dots, l$ , and put the labels  $K$  and  $K^{-1}$  on the maximal and minimal points, respectively, on strands running from left to right. After that, we multiply the labels on each strand, and take the tensor product. Thus, there is  $k \geq 0$  and a permutation  $\sigma \in \mathfrak{S}(2l + k)$  such that

$$J_{\tilde{T},s} \in (\mu^{[N_1, \dots, N_{2g}]} \circ \sigma)(S'(\alpha_{s(c_1)}^\pm) \otimes S'(\beta_{s(c_1)}^\pm) \otimes \dots \otimes S'(\alpha_{s(c_l)}^\pm) \otimes S'(\beta_{s(c_l)}^\pm) \otimes (\bar{U}_q^0)^{\otimes k}),$$

where, for each  $i = 1, \dots, 2g$ ,  $N_i \geq 0$  is the number of labels put on  $i$ -th strand of  $\tilde{T}$ .

By (36) and (38), we have  $J_{\tilde{T},s} \in \mathcal{F}(u)(1)$ , where

$$u = \langle \mu \rangle^{[N_1, \dots, N_{2g}]} \circ \sigma \left( \langle \alpha_{s(c_1)}^\pm \rangle \otimes \langle \beta_{s(c_1)}^\pm \rangle \otimes \dots \otimes \langle \alpha_{s(c_l)}^\pm \rangle \otimes \langle \beta_{s(c_l)}^\pm \rangle \otimes \langle \bar{U}_q^0 \rangle^{\otimes k} \right).$$

Here we identify  $\sigma \in \mathfrak{S}(2l + k)$  with the corresponding morphism in

$$\text{Hom}_{\mathcal{A}_{\mathfrak{S}}} (A^{\otimes 2l+k}, A^{\otimes 2l+k}).$$

By (39), we have

$$\bar{Y}^{\otimes g}(J_{\tilde{T},s}) \in \mathcal{F}(\langle \bar{Y} \rangle^{\otimes g} \circ u)(1).$$

Set  $B = \langle \bar{Y} \rangle^{\otimes g} \circ u \in \text{Hom}_{\mathcal{A}}(I, A^{\otimes g})$ . It is not difficult to check that  $B \in \Gamma_g$  as in Figure 21. In particular,  $B$  satisfies Condition A, since for each  $i = 1, \dots, l$ , the output edges of  $\langle \Theta_{s(c_i)} \rangle$  go down to the output edges of  $u$ , and there is a descending path from each output edge of  $u$  to an input edge of a  $\langle \bar{Y} \rangle$ ; see the dotted arrow in Figure 21 for example.  $\square$

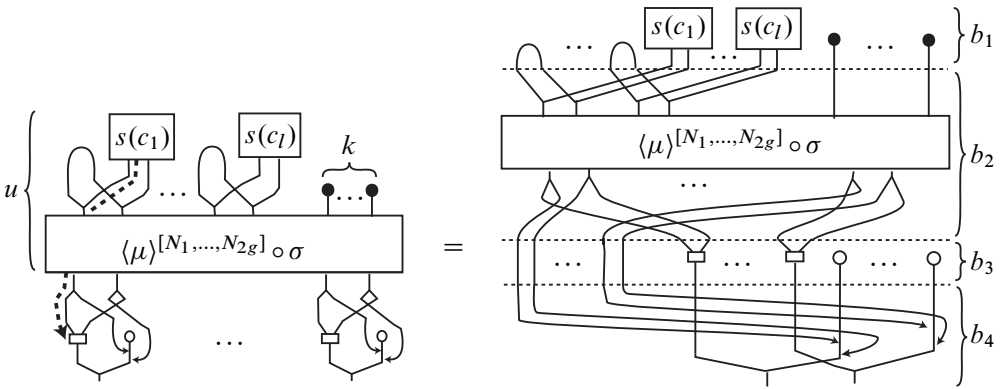

Figure 21.  $\langle \bar{Y} \rangle^{\otimes g} \circ u = b_4 \circ b_3 \circ b_2 \circ b_1$  with  $(b_1, b_2, b_3, b_4) \in \tilde{\Gamma}_g$

Proposition 3.11 follows from Lemma 5.1 and the following lemma.

**Lemma 5.2** For  $g \geq 0$ , we have  $\mathcal{F}(\Gamma_g)(1) \subset (\bar{U}_q^{ev})^{\otimes g}$ .

The outline of the proof of Lemma 5.2 is as follows. We define two subsets  $\Gamma'_g, \Gamma''_g \subset \Gamma_g$  such that  $\Gamma''_g \subset \Gamma'_g \subset \Gamma_g$ , and prove the inclusions

$$(40) \quad \mathcal{F}(\Gamma_g)(1) \subset \mathcal{F}(\Gamma'_g)(1) \subset \mathcal{F}'(\Gamma'_g)(1) \subset \mathcal{F}'(\Gamma''_g)(1) \subset (\bar{U}_q^{ev})^{\otimes g},$$

where  $\mathcal{F}'$  is a modification of the functor  $\mathcal{F}$ , which is defined in Section 5.4. Here, for a subset  $X \subset \text{Hom}_{\mathcal{A}}(I, A^{\otimes g})$ , we define  $\mathcal{F}'(X)(1)$  in a similar way to that of  $\mathcal{F}(X)(1)$ .

### 5.2 The subset $\Gamma'_g \subset \Gamma_g$

In this section, we define the subset  $\Gamma'_g \subset \Gamma_g$ .

For  $g \geq 0$ , let  $\dot{\Gamma}'_g$  be the set of 7-tuples  $(b_1, d, w, k, \sigma, b_3, b_4)$  of morphisms in  $\mathcal{A}$ , such that  $(b_1, \sigma \circ (d \otimes w \otimes k), b_3, b_4) \in \tilde{\Gamma}_g$  is well-defined,  $\sigma \in \text{Hom}(\mathcal{A}_{\otimes})$  and

$$b_1 = \langle D^{\pm 1} \rangle^{\otimes l_1} \otimes \langle \Theta_{s_1} \rangle \otimes \dots \otimes \langle \Theta_{s_{l_2}} \rangle \otimes (\bar{U}_q^0)^{\otimes l_3},$$

$$d \in \text{Hom}_{\mathcal{A}_\mu}(A^{\otimes 2l_1}, A^{\otimes l_4}), \quad w = \bigotimes_{p=1}^{l_2} (\langle \Delta \rangle^{[m_p, n_p]}), \quad k = \langle \Delta \rangle^{[r_1, \dots, r_{l_3}]},$$

for  $l_1, \dots, l_4, s_1, \dots, s_{l_2} \geq 0, m_1, \dots, m_{l_2}, n_1, \dots, n_{l_2}, r_1, \dots, r_{l_3} \geq 1$ . See Figure 22 for an example of  $\sigma \circ (d \otimes w \otimes k) \circ b_1$ .

Let  $\kappa: \dot{\Gamma}'_g \rightarrow \tilde{\Gamma}_g$  be the map defined by

$$\kappa(b_1, d, w, k, \sigma, b_3, b_4) = (b_1, \sigma \circ (d \otimes w \otimes k), b_3, b_4).$$

Set  $\tilde{\Gamma}'_g = \kappa(\dot{\Gamma}'_g) \subset \tilde{\Gamma}_g$  and  $\Gamma'_g = \lambda(\tilde{\Gamma}'_g) \subset \Gamma_g$ .

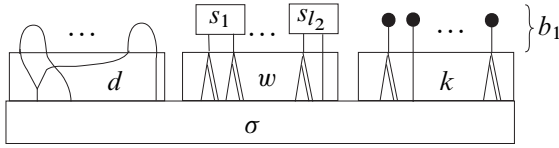

Figure 22. An example of  $\sigma \circ (d \otimes w \otimes k) \circ b_1$  for  $(b_1, d, w, k, \sigma, b_3, b_4) \in \hat{\Gamma}'_g$

### 5.3 Proof of $\mathcal{F}(\Gamma_g)(1) \subset \mathcal{F}(\Gamma'_g)(1)$

In this section, we define a preorder  $\preceq$  on  $\Gamma_g$ , and prove the following two lemmas, which imply  $\mathcal{F}(\Gamma_g)(1) \subset \mathcal{F}(\Gamma'_g)(1)$ .

**Lemma 5.3** For  $B \preceq B'$  in  $\Gamma_g$ , we have  $\mathcal{F}(B)(1) \subset \mathcal{F}(B')(1)$ .

**Lemma 5.4** For each  $B \in \Gamma_g$ , there exists  $B' \in \Gamma'_g$  such that  $B \preceq B'$ .

The preorder  $\preceq$  on  $\Gamma_g$  is generated by the binary relations  $\Rightarrow_i$  for  $i = 1, \dots, 8$  on  $\text{Hom}(\mathcal{A})$  defined by the local moves on diagrams as depicted in Figure 23, where in each relation, the outsides of the two rectangles are the same. Note that  $\Gamma_g$  is closed under  $\Rightarrow_i$  for  $i = 1, \dots, 8$ , ie, for  $B \Rightarrow_i B'$  in  $\text{Hom}(\mathcal{A})$ , if  $B \in \Gamma_g$ , then  $B' \in \Gamma_g$ . In particular, we can check that each  $\Rightarrow_i$  preserves Condition A.

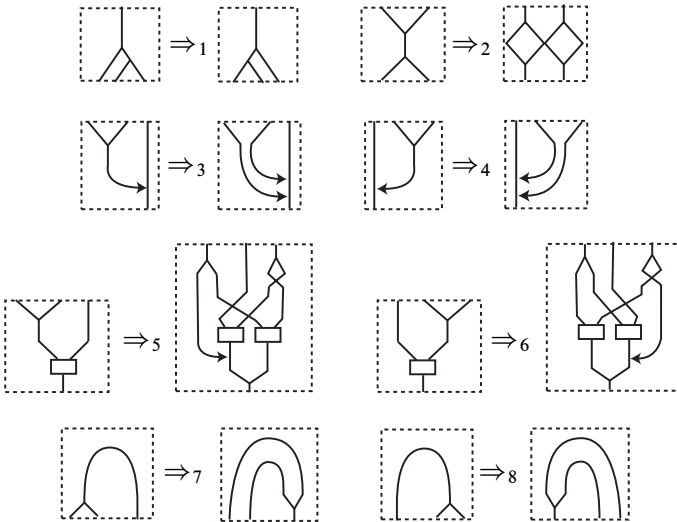

Figure 23. Local moves  $\Rightarrow_i$  for  $i = 1, \dots, 8$



**Proof of Lemma 5.3** It is enough to prove that, for  $B \Rightarrow_i B'$  in  $\Gamma_g$  with  $i \in \{1, \dots, 8\}$ , we have  $\mathcal{F}(B)(1) \subset \mathcal{F}(B')(1)$ .

The cases  $i = 1, 2, 3, 4$  are clear. The cases  $i = 5, 6$  follow from Lemma 3.7. The cases  $i = 7, 8$  follow from (5),  $\Delta(\bar{U}_q^0) \subset (\bar{U}_q^0)^{\otimes 2}$  and  $\bar{U}_q^0 \subset \mu((\bar{U}_q^0)^{\otimes 2})$ .  $\square$

The rest of this section is devoted to the proof of Lemma 5.4. We divide Lemma 5.4 into the following two claims.

**Claim 1** For  $b = (b_1, b_2, b_3, b_4) \in \tilde{\Gamma}_g$ , there exists  $b' = (b'_1, b'_2, b'_3, b'_4) \in \tilde{\Gamma}_g$  with  $b'_2 \in \text{Hom}(\mathcal{A}_\Delta)$  such that  $\lambda(b) \preceq \lambda(b')$ .

**Claim 2** For  $b' = (b'_1, b'_2, b'_3, b'_4) \in \tilde{\Gamma}_g$  with  $b'_2 \in \text{Hom}(\mathcal{A}_\Delta)$ , there exists  $b'' = (b''_1, b''_2, b''_3, b''_4) \in \tilde{\Gamma}'_g$  such that  $\lambda(b') \preceq \lambda(b'')$ .

Roughly speaking, we prove Claim 1 by reducing the number of the  $\langle \mu \rangle$ 's of  $b_2$  by using  $\Rightarrow_i$  for  $i = 3, \dots, 6$ . For that purpose, we define “ $\langle \mu \rangle$ -complexity” functions

$$||, m: \text{Hom}(\mathcal{A}_{\mu, \Delta}) \rightarrow \mathbb{Z}_{\geq 0}$$

as follows. Given an element  $b \in \text{Hom}(\mathcal{A}_{\mu, \Delta})$ , we color each edge of a diagram of  $b$  with a nonnegative integer. First, we color each edge on the top with 0. Then, we color the edges below inductively as in Figure 24(a). We define  $|b|$  as the maximal integer on the edges on the bottom. We define  $m(b)$  as the number of the edges on the bottom colored with  $|b|$ . For example, for the colored morphism  $f \in \text{Hom}(\mathcal{A}_{\mu, \Delta})$  in Figure 24(b), we have  $|f| = 3$ , and  $m(f) = 2$ .

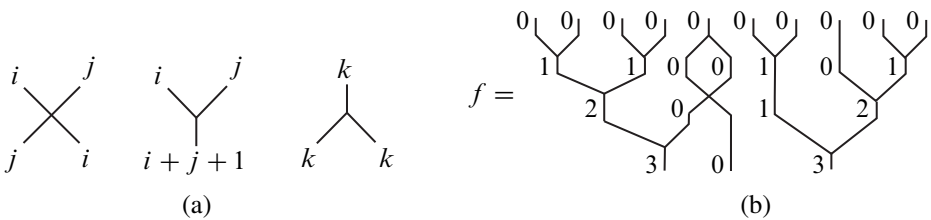

Figure 24. (a) How to color the edges (b) An example of the coloring

We use the following lemma.

**Lemma 5.5** For every  $B \in \text{Hom}(\mathcal{A}_{\mu, \Delta})$ , there exists  $B_\mu \in \text{Hom}(\mathcal{A}_\mu)$  and  $B_\Delta \in \text{Hom}(\mathcal{A}_\Delta)$  such that  $B \preceq B_\mu \circ B_\Delta$  and  $|B| = |B_\mu \circ B_\Delta|$ .

**Proof** We can realize a path from  $B$  to  $B_\mu \circ B_\Delta$  with some  $B_\mu \in \text{Hom}(\mathcal{A}_\mu)$  and  $B_\Delta \in \text{Hom}(\mathcal{A}_\Delta)$  by using  $\Rightarrow_2$ , which preserves  $||$  as in Figure 25.  $\square$

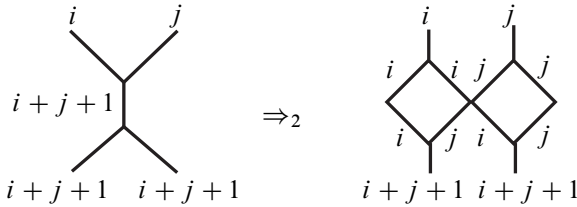

Figure 25. The coloring before and after we apply  $\Rightarrow_2$

**Proof of Claim 1** We use double induction on  $|b_2|$  and  $m(b_2)$ . If  $|b_2| = 0$ , then we have  $b_2 \in \text{Hom}(\mathcal{A}_\Delta)$ . We assume  $|b_2| > 0$ . It is enough to prove that there exists  $a = (a_1, a_2, a_3, a_4) \in \tilde{\Gamma}'_g$  such that  $\lambda(b) \preceq \lambda(a)$  satisfying either  $|b_2| > |a_2|$ , or  $|b_2| = |a_2|$  and  $m(b_2) > m(a_2)$ .

By Lemma 5.5, we can assume  $b_2 = b_{2,\mu} \circ b_{2,\Delta}$  with  $b_{2,\mu} \in \text{Hom}(\mathcal{A}_\mu)$  and  $b_{2,\Delta} \in \text{Hom}(\mathcal{A}_\Delta)$ . Since  $|b_{2,\mu}| = |b_2| > 0$ , there is a  $\langle \mu \rangle$  at the bottom of  $b_2$  whose output edge is colored by  $|b_2|$ . We define  $a = (a_1, a_2, a_3, a_4) \in \tilde{\Gamma}'_g$  as follows.

- (1) If the output edge of the  $\langle \mu \rangle$  is connected to the left input edge of an  $\langle \text{ad} \rangle$  (resp. the right input edge of an  $\langle \overline{\text{ad}} \rangle$ ), then let  $a$  be the element obtained from  $b$  by applying  $\Rightarrow_3$  to the  $\langle \text{ad} \rangle$  (resp.  $\Rightarrow_4$  to the  $\langle \overline{\text{ad}} \rangle$ ) in  $\lambda(b)$  as in Figure 26(a) (resp. (b)).

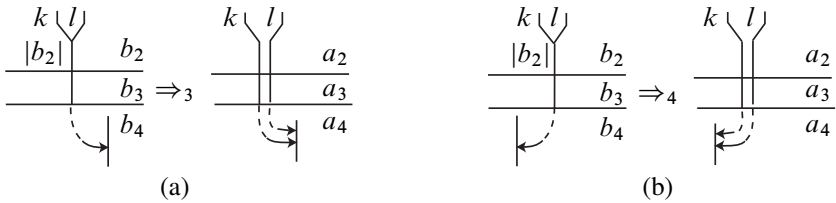

Figure 26. How to obtain  $a = (a_1, a_2, a_3, a_4) \in \tilde{\Gamma}'_g$  from  $b$ , where  $k, l \geq 0$ ,  $k + l + 1 = |b_2|$

- (2) If the output edge of the  $\langle \mu \rangle$  is connected to the left (resp. right) input edge of a  $\langle \dot{Y} \rangle$ , then let  $a$  be the element obtained from  $b$  by applying  $\Rightarrow_5$  (resp.  $\Rightarrow_6$ ) on the  $\langle \dot{Y} \rangle$  in  $\lambda(b)$  as in Figure 27(a) (resp. (b)).

If  $m(b_2) = 1$ , then we have  $|b_2| > |a_2|$ . If  $m(b_2) > 1$ , then we have  $|b_2| = |a_2|$  and  $m(b_2) > m(a_2)$ . This completes the proof. □

**Proof of Claim 2** We transform  $b'_2 \circ b'_1$  into  $b''_2 \circ b''_1$  such that  $b'' = (b''_1, b''_2, b'_3, b'_4) \in \tilde{\Gamma}'_g$  by the two steps as in Figure 28. That is,

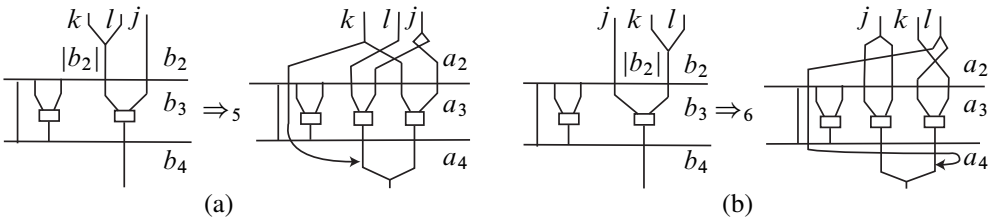

Figure 27. How to obtain  $a = (a_1, a_2, a_3, a_4) \in \tilde{\Gamma}_g$  from  $b$ , where  $j, k, l \geq 0$ ,  $k + l + 1 = |b_2|$

- (i) we can transform  $b'_2$  into  $\sigma \circ \langle \Delta \rangle^{[m_1, \dots, m_l]}$  for some  $\sigma \in \text{Hom}(\mathcal{A}_{\mathbb{S}})$ ,  $l \geq 0$ ,  $m_1, \dots, m_l \geq 1$  by using  $\Rightarrow_1$ , and
- (ii) we can transform  $(\langle \Delta \rangle^{[m]} \otimes \langle \Delta \rangle^{[n]}) \circ \langle D^{\pm 1} \rangle$ ,  $m, n \geq 1$ , into  $a \circ \langle D^{\pm 1} \rangle^{\otimes mn}$ , for some  $a \in \text{Hom}_{\mathcal{A}_{\mu}}(2mn, m + n)$ , by using  $\Rightarrow_2$ ,  $\Rightarrow_7$ , and  $\Rightarrow_8$  as depicted in Figure 29.

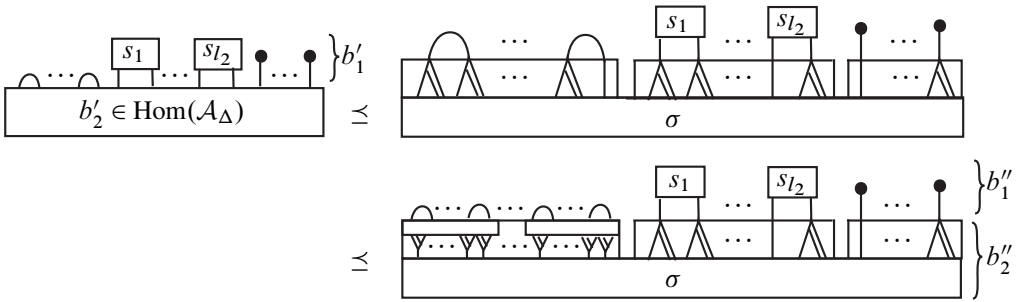

Figure 28. How to transform  $b'_2 \circ b'_1$  to  $b''_2 \circ b'_1$

Hence we have the assertion. □

### 5.4 The functor $\mathcal{F}'$ and proof of $\mathcal{F}'(\Gamma'_g)(1) \subset \mathcal{F}'(\Gamma'_g)(1)$

In this section, we define the symmetric monoidal functor  $\mathcal{F}': \mathcal{A} \rightarrow \mathcal{M}$  and prove  $\mathcal{F}'(\Gamma'_g)(1) \subset \mathcal{F}'(\Gamma'_g)(1)$ .

For  $n \geq 0$ , we equip  $U_h^{\widehat{\otimes} n}$  with the topological  $\mathbb{Z}^n$ -graded algebra structure such that

$$\text{deg}(x_1 \otimes \dots \otimes x_n) = (|x_1|, \dots, |x_n|),$$

for homogeneous elements  $x_1, \dots, x_n \in U_h$  with respect to the topological  $\mathbb{Z}$ -grading of  $U_h$  defined in Section 2.2.

For  $k, l \geq 0$ , we call a map  $f: U_h^{\widehat{\otimes} k} \rightarrow U_h^{\widehat{\otimes} l}$  homogeneous if it sends each homogeneous element to a homogeneous element. We call a morphism  $X: k \rightarrow l$  in  $\mathcal{M}$

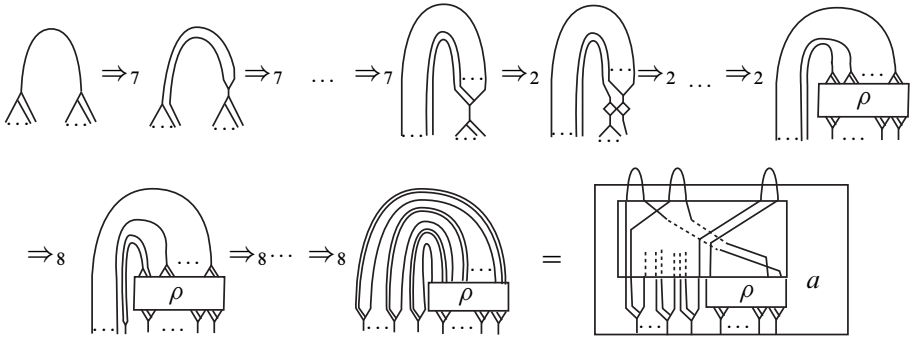

Figure 29. How to transform  $(\langle \Delta \rangle^{[m]} \otimes \langle \Delta \rangle^{[n]}) \circ \langle D^{\pm 1} \rangle$  into  $a \circ \langle D^{\pm 1} \rangle^{\otimes mn}$ , where  $\rho \in \text{Hom}(\mathcal{A}_{\mathfrak{S}})$

homogeneous if it is generated by homogeneous maps as a  $\mathbb{Z}[q, q^{-1}]$ -submodule of  $\text{Hom}_{\mathbb{Q}[[\hbar]]}^{\text{cts}}(U_h^{\otimes k}, U_h^{\otimes l})$ . Note that the image by the functor  $\mathcal{F}$  of each generator morphism in  $\mathcal{A}$  except  $\langle \Delta \rangle$  in Section 4.2 is homogeneous.

We define  $\mathcal{F}'$  in the same way as  $\mathcal{F}$  except that we set  $\mathcal{F}'(\langle \Delta \rangle) = \sum_{j \in \mathbb{Z}} \mathbb{Z}[q, q^{-1}] \Delta_j$  instead of  $\mathcal{F}(\langle \Delta \rangle) = \mathbb{Z}[q, q^{-1}] \Delta$ . Here, for  $j \in \mathbb{Z}$ ,  $\Delta_j: U_h \rightarrow U_h \hat{\otimes} U_h$  is the continuous  $\mathbb{Q}[[\hbar]]$ -linear map defined by

$$\Delta_j(x) = \sum x_{(1)} \otimes p_j(x_{(2)}),$$

for  $x \in U_h$ , where  $p_j: U_h \rightarrow U_h$  is the projection map defined by

$$p_j(y) = \begin{cases} y & \text{if } |y| = j, \\ 0 & \text{otherwise,} \end{cases}$$

for  $y \in U_h$  homogeneous. Since  $\mathcal{F}'(\langle \Delta \rangle)$  is homogeneous,  $\mathcal{F}'$  sends each generator morphism in  $\mathcal{A}$  to a homogeneous module. Moreover, since the compositions and the tensor products of homogeneous objects in  $\mathcal{M}$  are also homogeneous, the image by  $\mathcal{F}'$  of each morphism in  $\mathcal{A}$  is homogeneous.

We prove  $\mathcal{F}(\Gamma'_g)(1) \subset \mathcal{F}'(\Gamma'_g)(1)$ . For  $x \in U_h$  a finite linear combination of homogeneous elements, it is easy to check that

$$(41) \quad \Delta(x) = \sum_{j \in \mathbb{Z}} \Delta_j(x),$$

$$(42) \quad \mathcal{F}(\langle \Delta \rangle)(x) = (\mathbb{Z}[q, q^{-1}] \Delta)(x) \subset \left( \sum_{j \in \mathbb{Z}} \mathbb{Z}[q, q^{-1}] \Delta_j \right)(x) = \mathcal{F}'(\langle \Delta \rangle)(x).$$

(In fact, (41) is true for all  $x \in U_h$ . However, (42) is not, since  $\sum_{j \in \mathbb{Z}} \mathbb{Z}[q, q^{-1}] \Delta_j$  consists of finite linear combinations of  $\Delta_j$  for  $j \in \mathbb{Z}$ .)

Note that each  $\langle \Delta \rangle$  in a diagram of  $B \in \Gamma'_g$  is contained in a  $\langle \Delta \rangle^{[n]} \langle \tilde{E}^{(m)} \rangle$ , in a  $\langle \Delta \rangle^{[n]} \langle \tilde{F}^{(m)} \rangle$ , or in a  $\langle \Delta \rangle^{[n]} \langle \bar{U}_q^0 \rangle$  for  $m, n \geq 0$ . By (42), we can prove that

$$\begin{aligned} \mathcal{F}(\langle \Delta \rangle^{[n]} \langle \tilde{E}^{(m)} \rangle)(1) &\subset \mathcal{F}'(\langle \Delta \rangle^{[n]} \langle \tilde{E}^{(m)} \rangle)(1), \\ \mathcal{F}(\langle \Delta \rangle^{[n]} \langle \tilde{F}^{(m)} \rangle)(1) &\subset \mathcal{F}'(\langle \Delta \rangle^{[n]} \langle \tilde{F}^{(m)} \rangle)(1), \end{aligned}$$

for  $m, n \geq 0$ , by using induction on  $n$ . For  $y \in U_h^0$ , we have

$$\mathcal{F}(\langle \Delta \rangle)(y) = (\mathbb{Z}[q, q^{-1}] \Delta_0)(y) = \mathcal{F}'(\langle \Delta \rangle)(y).$$

Thus, we have  $\mathcal{F}(B)(1) \subset \mathcal{F}'(B)(1)$ , which completes the proof.

### 5.5 The subset $\Gamma''_g \subset \Gamma'_g$

In this section, we define the subset  $\Gamma''_g \subset \Gamma'_g$ .

In what follows, we color each edge of a diagram of  $B \in \Gamma'_g$  with  $d, w, k$  or  $\emptyset$  as follows. First, we color the output edges in  $b_1$  of  $\langle D^{\pm 1} \rangle$ 's,  $\langle \Theta_i \rangle$ 's, and  $\langle \bar{U}_q^0 \rangle$ 's with  $d, w$ , and  $k$ , respectively. Then, we color the edges below as in Figure 30(a). See Figure 30(b) for an example of  $G \in \Gamma'_2$  with the coloring.

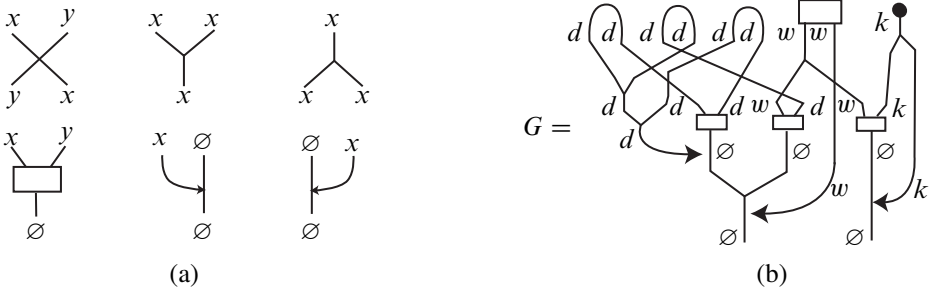

Figure 30. (a) How to color the edges (b) An example of the coloring

For  $g \geq 0$ , let  $\dot{\Gamma}''_g \subset \dot{\Gamma}'_g$  be the subset consisting of  $b = (b_1, d, w, k, \sigma, b_3, b_4)$  such that

- $(C_{dk})$   $d$  and  $k$  are the identity morphisms in  $\mathcal{A}$ ,
- $(C_{ad})$  in  $(\lambda \circ \kappa)(b)$ , there is no  $\langle ad \rangle$  (resp.  $\langle \overline{ad} \rangle$ ) with the  $d$ -colored left (resp. right) input edge, ie, the first  $l$  input edges of  $b_3 = \text{id}_A^{\otimes l} \otimes \langle \dot{Y} \rangle^{\otimes m} \otimes \langle \bar{U}_q^{\text{ev}0} \rangle^{\otimes n}$  are not colored by  $d$ ,
- $(C_Y)$  there is no  $\langle \dot{Y} \rangle$  with both the left and the right input edges colored by  $d$ .

See Figure 31 for an example of  $b_3 \circ \sigma \circ (d \otimes w \otimes k) \circ b_1$ .

Set

$$\begin{aligned} \tilde{\Gamma}_g'' &= \kappa(\dot{\Gamma}_g'') \subset \tilde{\Gamma}_g', \\ \Gamma_g'' &= \lambda(\tilde{\Gamma}_g'') \subset \Gamma_g'. \end{aligned}$$

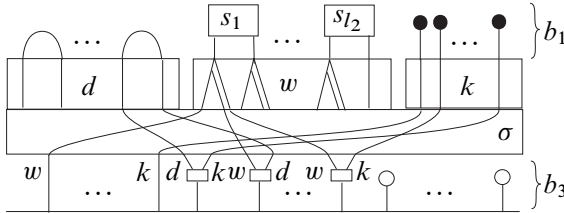

Figure 31. An example of  $b_3 \circ \sigma \circ (d \otimes w \otimes k) \circ b_1$  for  $(b_1, d, w, k, \sigma, b_3, b_4) \in \dot{\Gamma}_g''$

### 5.6 Proof of $\mathcal{F}'(\Gamma_g')(1) \subset \mathcal{F}'(\Gamma_g'')(1)$

Similarly to Section 5.3, we define a preorder  $\preceq'$  on  $\Gamma_g'$ , and prove the following two lemmas, which imply  $\mathcal{F}'(\Gamma_g')(1) \subset \mathcal{F}'(\Gamma_g'')(1)$ .

**Lemma 5.6** For  $B \preceq' B'$  in  $\Gamma_g'$ , we have  $\mathcal{F}'(B)(1) \subset \mathcal{F}'(B')(1)$ .

**Lemma 5.7** For each element  $B \in \Gamma_g'$ , there exists  $B' \in \Gamma_g''$ , such that  $B \preceq' B'$ .

The preorder  $\preceq'$  on  $\Gamma_g'$  is generated by binary relations  $\Rightarrow_i$  for  $i = 9, \dots, 13$  on  $\Gamma_g'$ . In the present case, we divide the definitions of the binary relations into three. Correspondingly, the proof of Lemma 5.6 is divided into these of Lemmas 5.9, 5.11 and 5.14.

For  $B \in \Gamma_g'$ , let  $N_d(B) \geq 0$  be the number of the  $\langle \mu \rangle$ 's colored by  $d$  (ie, the number of the  $\langle \mu \rangle$ 's in  $b_2$ ),  $N_k(B) \geq 0$  be the number of  $\langle \Delta \rangle$ 's colored by  $k$ ,  $N_{ad}(B) \geq 0$  the number of the  $\langle ad \rangle$ 's with  $d$ -colored left input edges and the  $\langle \overline{ad} \rangle$ 's with  $d$ -colored right input edges, and  $N_Y(B) \geq 0$  the number of the  $\langle \dot{Y} \rangle$ 's with both the left and the right input edges  $d$ -colored. For example, for  $G \in \Gamma_2'$  as in Figure 30(b), we have  $N_d(G) = 2$ ,  $N_k(G) = 1$ ,  $N_{ad}(G) = 1$ , and  $N_Y(G) = 1$ .

Note that for  $B \in \Gamma_g'$ , we have  $B \in \Gamma_g''$  if and only if  $N_d(B) = N_k(B) = N_{ad}(B) = N_Y(B) = 0$ . By using induction on  $N_{ad}(B)$ ,  $N_Y(B)$ ,  $N_d(B)$  and  $N_k(B)$ , Lemma 5.7 follows from Lemmas 5.8, 5.10, 5.12 and 5.13.

**5.6.1 Binary relation  $\Rightarrow_9$**  Let  $\rightsquigarrow_i$  for  $i = 1, \dots, 8$  be the local moves on diagrams of morphisms in  $\mathcal{A}$  as depicted in Figure 32, where in each relation, the outsides of the two rectangles are the same. For  $B, B' \in \Gamma'_g$ , we write  $B \Rightarrow_9 B'$  if there exists  $B'' \in \text{Hom}(\mathcal{A})$  such that either  $B \rightsquigarrow_1 B''$  or  $B \rightsquigarrow_2 B''$ , and there exists a sequence from  $B''$  to  $B'$  in  $\text{Hom}(\mathcal{A})$  of moves  $\rightsquigarrow_i$  for  $i = 3, \dots, 8$ .

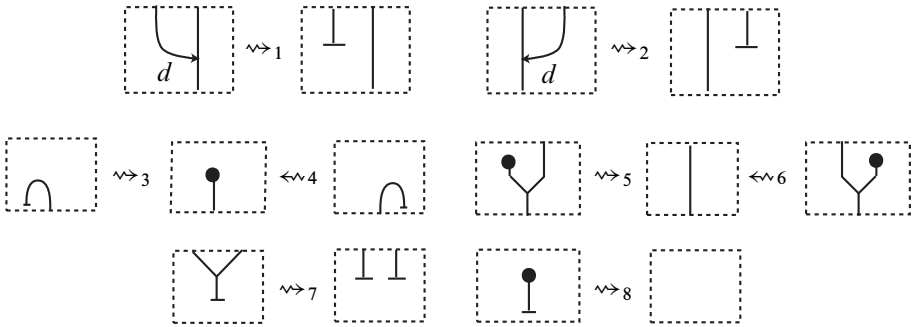

Figure 32. Local moves  $\rightsquigarrow_i$  for  $i = 1, \dots, 8$

**Lemma 5.8** For  $B \in \Gamma'_g$  with  $N_{\text{ad}}(B) > 0$ , there exists  $B' \in \Gamma'_g$  such that  $B \Rightarrow_9 B'$  and  $N_{\text{ad}}(B) > N_{\text{ad}}(B')$ .

**Proof** We can transform  $B$  into  $B'$  satisfying the conditions in the lemma as follows. Since  $N_{\text{ad}}(B) > 0$ , there exists  $B''$  obtained from  $B$  by applying  $\rightsquigarrow_1$  or  $\rightsquigarrow_2$ . There is an  $\langle \varepsilon \rangle$  in  $B''$ , and we continue the transformation as follows.

- ( $\varepsilon_1$ ) If the  $\langle \varepsilon \rangle$  is connected to the left (resp. right) output edge of a  $\langle D^{\pm 1} \rangle$ , then we apply  $\rightsquigarrow_3$  (resp.  $\rightsquigarrow_4$ ). If the new  $\langle \bar{U}_q^0 \rangle$  is connected to the left (resp. right) input edge of a  $\langle \mu \rangle$ , then we apply  $\rightsquigarrow_5$  (resp.  $\rightsquigarrow_6$ ), otherwise we put its edge into the  $k$ -part.
- ( $\varepsilon_2$ ) If the  $\langle \varepsilon \rangle$  is connected to an output edge of a  $\langle \mu \rangle$ , then we apply  $\rightsquigarrow_7$ . Then, for each new  $\langle \varepsilon \rangle$ , we continue the transformation similarly. If there appears  $\langle \varepsilon \rangle \circ \langle \bar{U}_q^0 \rangle$ , then we apply  $\rightsquigarrow_8$ .

For example, see Figure 33, where a dotted circle with a number  $i$  attached is a place to where we apply  $\rightsquigarrow_i$ . It is easy to check that the procedure terminates, and the result  $B'$  is contained in  $\Gamma'_g$ . One can check that  $N_{\text{ad}}(B') = N_{\text{ad}}(B) - 1$ .  $\square$

**Lemma 5.9** For  $B \Rightarrow_9 B'$  in  $\Gamma'_g$ , we have  $\mathcal{F}'(B)(1) \subset \mathcal{F}'(B')(1)$ .

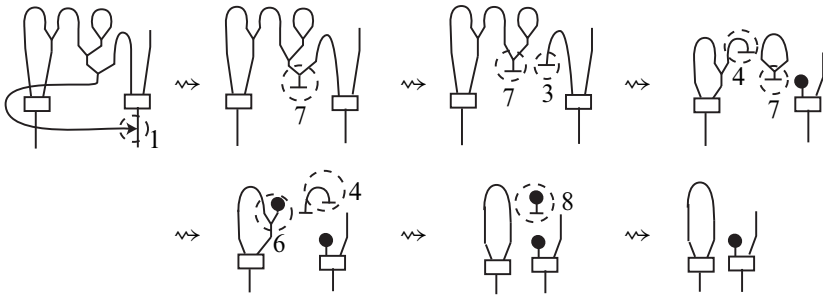

Figure 33. Binary relation  $\Rightarrow_9$

**Proof** It is enough to prove that, for  $C \rightsquigarrow_j C'$  with  $j \in \{1, \dots, 8\}$  in the sequence of the local moves from  $B$  to  $B'$ , we have  $\mathcal{F}'(C)(1) \subset \mathcal{F}'(C')(1)$ .

Consider the case  $j = 1$ . The case  $j = 2$  is similar. Recall from Section 5.4 that the image by  $\mathcal{F}'$  of each morphism in  $\mathcal{A}$  is homogeneous. This implies that, for each  $b \in \text{Hom}_{\mathcal{A}}(I, A^{\otimes l})$ ,  $l \geq 0$ , the  $\mathbb{Z}[q, q^{-1}]$ -submodule  $\mathcal{F}'(b)(1)$  of  $U_h^{\widehat{\otimes} l}$  is generated by homogeneous elements of  $U_h^{\widehat{\otimes} l}$ . Thus, the case  $j = 1$  follows from

$$\begin{aligned} & \sum \text{ad}(\bar{U}_q^0 D'_{1,\pm} \cdots D'_{n,\pm} (D'_{\pm} D''_{\pm})^m \otimes x) \otimes \bar{U}_q^0 D'_{1,\pm} \otimes \cdots \otimes \bar{U}_q^0 D''_{n,\pm} \\ & \subset x \otimes (\bar{U}_q^0)^{\otimes n} \\ & \subset \sum (\varepsilon \otimes \text{id}_{U_h})(\bar{U}_q^0 D'_{1,\pm} \cdots D'_{n,\pm} (D'_{\pm} D''_{\pm})^m \otimes x) \otimes \bar{U}_q^0 D'_{1,\pm} \otimes \cdots \otimes \bar{U}_q^0 D''_{n,\pm}, \end{aligned}$$

for  $m, n \geq 0$  and  $x \in U_h$  homogeneous, where we set  $D^{\pm 1} = \sum D'_{i,\pm} \otimes D''_{i,\pm}$  for  $1 \leq i \leq n$ . Here, we use from [23, Lemma 5.2] the identities

$$\begin{aligned} \sum \text{ad}(D'_{\pm} \otimes x) \otimes D''_{\pm} &= x \otimes K^{\pm|x|}, \\ \sum \text{ad}(D'_{\pm} D''_{\pm} \otimes x) &= q^{|x|^2} x, \end{aligned}$$

for  $x \in U_h$  homogeneous.

The cases  $j = 3, 4$  follow from

$$(\varepsilon \otimes \text{id}_{U_h}) \circ ((\bar{U}_q^0)^{\otimes 2} D^{\pm 1}) = \bar{U}_q^0 = (\text{id}_{U_h} \otimes \varepsilon) \circ ((\bar{U}_q^0)^{\otimes 2} D^{\pm 1}).$$

The other cases  $j = 5, 6, 7, 8$  are clear. Hence we have the assertion. □

**5.6.2 Binary relation  $\Rightarrow_{10}$**  Let  $\rightsquigarrow_i$  for  $i = 9, \dots, 16$  be the local moves as depicted in Figure 34, where in each relation, the outsides of the two rectangles are the same. Here, the bottom lines in  $\rightsquigarrow_{12}$  is the bottom lines of the morphisms. For  $B, B' \in \Gamma'_g$ ,



we write  $B \Rightarrow_{10} B'$  if there exist  $B'' \in \text{Hom}(\mathcal{A})$  such that  $B \rightsquigarrow_9 B''$  and there is a sequence from  $B''$  to  $B'$  in  $\text{Hom}(\mathcal{A})$  of moves  $\rightsquigarrow_i$  for  $i = 3, \dots, 8, 10, \dots, 16$ .

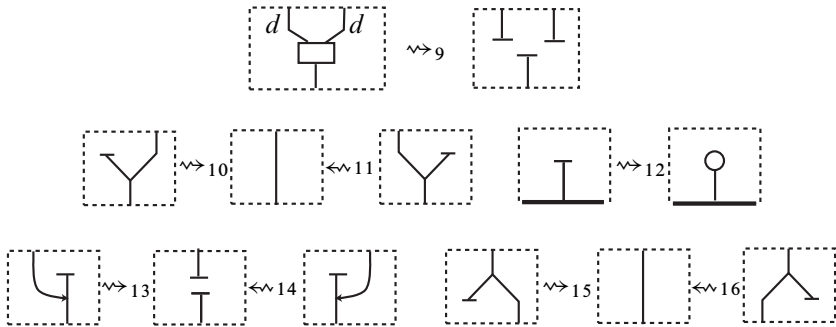

Figure 34. Local moves  $\rightsquigarrow_i$  for  $i = 9, \dots, 16$

**Lemma 5.10** For  $B \in \Gamma'_g$  with  $N_Y(B) > 0$  and  $N_{\text{ad}}(B) = 0$ , there exists  $B' \in \Gamma'_g$  such that  $B \Rightarrow_{10} B'$ ,  $N_Y(B) > N_Y(B')$ , and  $N_{\text{ad}}(B') = 0$ .

**Proof** We can transform  $B$  into  $B'$  satisfying the conditions in the lemma as follows. Since  $N_Y(B) > 0$ , there exists  $B''$  obtained from  $B$  by applying  $\rightsquigarrow_9$ . For each  $\langle \varepsilon \rangle$  in  $B''$ , we continue the transformation as in  $(\varepsilon 1)$  and  $(\varepsilon 2)$  in the proof of Lemma 5.8. For the  $\langle \eta \rangle$  in  $B''$ , we continue the transformation as follows.

- $(\eta 1)$  If the  $\langle \eta \rangle$  is connected to the left (resp. right) input edge of a  $\langle \mu \rangle$ , then we apply  $\rightsquigarrow_{10}$  (resp.  $\rightsquigarrow_{11}$ ).
- $(\eta 2)$  If the  $\langle \eta \rangle$  is connected to the bottom of the diagram, then we replace the  $\langle \eta \rangle$  with  $\langle \bar{U}_q^{\text{ev}0} \rangle$  by using  $\rightsquigarrow_{12}$ .
- $(\eta 3)$  If the  $\langle \eta \rangle$  is connected to the right (resp. left) input edge of an  $\langle \text{ad} \rangle$  (resp.  $\langle \bar{\text{ad}} \rangle$ ), then we apply  $\rightsquigarrow_{13}$  (resp.  $\rightsquigarrow_{14}$ ). Then, there appear an  $\langle \eta \rangle$  and an  $\langle \varepsilon \rangle$ . For the  $\langle \eta \rangle$ , we continue the transformation similarly. Consider the  $\langle \varepsilon \rangle$ . Since  $N_{\text{ad}}(B'') = 0$ , it is not colored by  $d$ , ie, it is colored by  $w$  or  $k$ . By Condition A in the definition of  $\tilde{\Gamma}_g$ , the  $\langle \varepsilon \rangle$  cannot be connected directly to any output edge of the  $\langle \Theta_i \rangle$ 's. Hence the  $\langle \varepsilon \rangle$  is connected to either an output edge of a  $\langle \Delta \rangle$  or the output edge of a  $\langle \bar{U}_q^0 \rangle$ . If the  $\langle \varepsilon \rangle$  is connected to the left (resp. right) output edge of a  $\langle \Delta \rangle$ , then we apply  $\rightsquigarrow_{15}$  (resp.  $\rightsquigarrow_{16}$ ). If the  $\langle \varepsilon \rangle$  is connected to a  $\langle \bar{U}_q^0 \rangle$ , we apply  $\rightsquigarrow_8$ .

For example, see Figure 35. It is easy to check that the procedure terminates, and the result  $B'$  is contained in  $\Gamma'_g$ . One can check that  $N_Y(B') = N_Y(B) - 1$  and  $N_{\text{ad}}(B') = N_{\text{ad}}(B) = 0$ . □

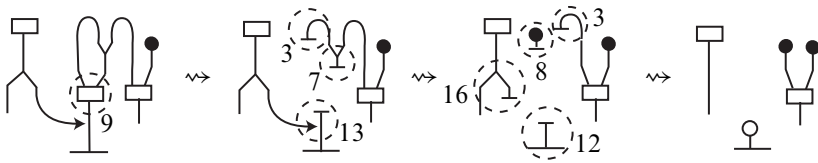

Figure 35. Binary relation  $\Rightarrow_{10}$

**Lemma 5.11** For  $B \Rightarrow_{10} B'$  in  $\Gamma'_g$ , we have  $\mathcal{F}'(B)(1) \subset \mathcal{F}'(B')(1)$ .

**Proof** It is enough to prove that, for  $C \rightsquigarrow_j C'$  with  $j \in \{9, \dots, 16\}$  in the sequence of the local moves from  $B$  to  $B'$ , we have  $\mathcal{F}'(C)(1) \subset \mathcal{F}'(C')(1)$ .

The case  $j = 9$  follows from Lemma 3.8.

The case  $j = 15, 16$  follow from

$$\begin{aligned}
 ((\varepsilon \otimes \text{id}_{U_h}) \circ \Delta_k)(\tilde{F}^{(l)} \bar{U}_q^0 \tilde{E}^{(m)}) &= \begin{cases} \tilde{F}^{(l)} \bar{U}_q^0 \tilde{E}^{(m)} & \text{if } k = m - l, \\ 0 & \text{otherwise,} \end{cases} \\
 ((\text{id}_{U_h} \otimes \varepsilon) \circ \Delta_k)(\tilde{F}^{(l)} \bar{U}_q^0 \tilde{E}^{(m)}) &= \begin{cases} \tilde{F}^{(l)} \bar{U}_q^0 \tilde{E}^{(m)} & \text{if } k = 0, \\ 0 & \text{otherwise,} \end{cases}
 \end{aligned}$$

respectively, for  $k, l, m \geq 0$ .

The other cases  $j = 10, \dots, 14$  are clear. Hence we have the assertion. □

**5.6.3 Binary relation  $\Rightarrow_i$  for  $i = 11, 12, 13$**  Let  $\Rightarrow_i$  for  $i = 11, 12, 13$  be the binary relations on  $\Gamma'_g$  defined by the local moves on diagrams as in Figure 36, where in each relation, the outsides of the two rectangles are the same. It is easy to check that  $\Gamma'_g$  is closed under  $\Rightarrow_i$  for  $i = 11, 12, 13$ .

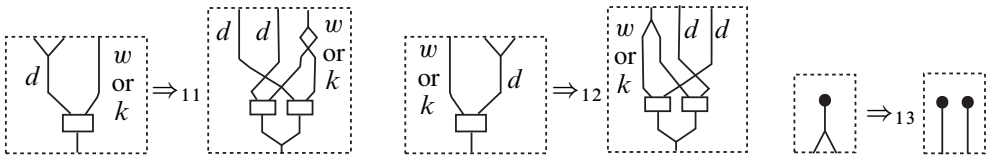

Figure 36. Local moves  $\Rightarrow_i$  for  $i = 11, 12, 13$

**Lemma 5.12** For  $B \in \Gamma'_g$  with  $N_d(B) > 0$ ,  $N_{\text{ad}}(B) = N_Y(B) = 0$ , there exists  $B' \in \Gamma'_g$  such that  $B \Rightarrow_i B'$  with  $i \in \{11, 12\}$ ,  $N_d(B) > N_d(B')$ , and  $N_{\text{ad}}(B') = N_Y(B') = 0$ .

**Proof** The condition  $N_d(B) > 0$  implies that there is a  $\langle \mu \rangle$  colored by  $d$  in  $b_2$ . Since  $N_{ad}(B) = 0$ , the output edge of the  $\langle \mu \rangle$  is connected to an input edge of a  $\langle \dot{Y} \rangle$ . (Note that each straight segment in  $b_3$  is connected to the left input edge of an  $\langle ad \rangle$  or the right input edge of an  $\langle \overline{ad} \rangle$  in  $b_4$ .) Moreover,  $N_Y(B) = 0$  implies that the other input edge of the  $\langle \dot{Y} \rangle$  is colored by  $w$  or  $k$ . Thus, we can apply  $\Rightarrow_i$  with  $i \in \{11, 12\}$  to  $B$  and denote the result by  $B' \in \Gamma'_g$ . Since  $N_d(B') = N_d(B) - 1$  and  $\Rightarrow_i$  preserves  $N_{ad}$  and  $N_Y$ , we have the assertion.  $\square$

**Lemma 5.13** For  $B \in \Gamma'_g$  with  $N_k(B) > 0$ ,  $N_d(B) = N_{ad}(B) = N_Y(B) = 0$ , there exists  $B' \in \Gamma'_g$  such that  $B \Rightarrow_{13} B'$ ,  $N_k(B) > N_k(B')$ , and  $N_d(B') = N_{ad}(B') = N_Y(B') = 0$ .

**Proof** The conditions  $N_k(B) > 0$  imply there exists  $B'$  obtained from  $B$  by applying  $\Rightarrow_{13}$ . Since  $N_k(B') = N_k(B) - 1$  and  $\Rightarrow_{13}$  preserves  $N_d$ ,  $N_{ad}$  and  $N_Y$ , we have the assertion.  $\square$

**Lemma 5.14** For  $B \Rightarrow_i B'$  in  $\Gamma'_g$  with  $i \in \{11, 12, 13\}$ , we have  $\mathcal{F}'(B)(1) \subset \mathcal{F}'(B')(1)$ .

**Proof** Consider the case  $i = 11$ . The case  $i = 12$  is similar. We can prove the assertion by two steps as in Figure 37, ie, for  $C \Rightarrow_5 C'$  in  $\Gamma'_g$ , we have  $F'(C)(1) \subset F'(C')(1)$  by (21) and (42), and we have

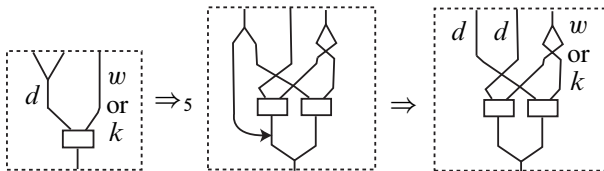

Figure 37. Graphical proof of the case  $i = 11$

$$\begin{aligned} & \sum \text{ad}((\bar{U}_q^0 D'_{1,\pm} \cdots D'_{n,\pm} (D'_\pm D''_\pm)^m)_{(1)} \otimes x) \\ & \quad \otimes (\bar{U}_q^0 D'_{1,\pm} \cdots D'_{n,\pm} (D'_\pm D''_\pm)^m)_{(2)} \otimes \bar{U}_q^0 D''_{1,\pm} \otimes \cdots \otimes \bar{U}_q^0 D''_{n,\pm} \\ & \quad \subset x \otimes \bar{U}_q^0 D'_{1,\pm} \cdots D'_{n,\pm} (D'_\pm D''_\pm)^m \otimes \bar{U}_q^0 D''_{1,\pm} \otimes \cdots \otimes \bar{U}_q^0 D''_{n,\pm}, \end{aligned}$$

for  $m, n \geq 0$  and  $x \in U_h$  homogeneous.

The case  $\Rightarrow_{13}$  follows from  $\Delta(\bar{U}_q^0) \subset (\bar{U}_q^0)^{\otimes 2}$ . Hence we have the assertion.  $\square$

### 5.7 Expansion of the elements in $\Gamma_g''$

In the next section, we prove  $\mathcal{F}'(\Gamma_g'')(1) \subset (\bar{U}_q^{\text{ev}})^{\otimes g}$ , which completes the proof of the sequence (40). Before that, we expand the elements in  $\Gamma_g''$  into ‘‘homogeneous’’ elements.

First of all, we define notation. For  $m \geq 0, n \geq 1$ , set

$$\mathcal{I}(m, n) = \{(i_1, \dots, i_n) \mid i_1, \dots, i_n \geq 0, i_1 + \dots + i_n = m\}.$$

For  $\mathbf{i} = (i_1, \dots, i_n) \in \mathcal{I}(m, n)$ , set

$$\begin{aligned} \tilde{E}^{\mathbf{i}} &= (\bar{U}_q^0)^{\otimes n} (\tilde{E}^{(i_1)} \otimes \dots \otimes \tilde{E}^{(i_n)}) \subset (U_{\mathbb{Z},q})^{\otimes n}, \\ \tilde{F}^{\mathbf{i}} &= (\bar{U}_q^0)^{\otimes n} (\tilde{F}^{(i_1)} \otimes \dots \otimes \tilde{F}^{(i_n)}) \subset (U_{\mathbb{Z},q})^{\otimes n}, \\ \langle \tilde{E}^{\mathbf{i}} \rangle &= \langle \tilde{E}^{(i_1)} \rangle \otimes \dots \otimes \langle \tilde{E}^{(i_n)} \rangle \in \text{Hom}_{\mathcal{A}}(I, A^{\otimes n}), \\ \langle \tilde{F}^{\mathbf{i}} \rangle &= \langle \tilde{F}^{(i_1)} \rangle \otimes \dots \otimes \langle \tilde{F}^{(i_n)} \rangle \in \text{Hom}_{\mathcal{A}}(I, A^{\otimes n}). \end{aligned}$$

Clearly, we have

$$\tilde{E}^{\mathbf{i}} = \mathcal{F}'(\langle \tilde{E}^{\mathbf{i}} \rangle)(1), \quad \tilde{F}^{\mathbf{i}} = \mathcal{F}'(\langle \tilde{F}^{\mathbf{i}} \rangle)(1).$$

We use the following lemma.

**Lemma 5.15** For  $m \geq 0, n \geq 1$ , we have

$$\begin{aligned} \mathcal{F}'(\langle \Delta \rangle^{[n]} \circ \langle \tilde{E}^{(m)} \rangle)(1) &\subset \sum_{\mathbf{i} \in \mathcal{I}(m,n)} \mathcal{F}'(\langle \tilde{E}^{\mathbf{i}} \rangle)(1), \\ \mathcal{F}'(\langle \Delta \rangle^{[n]} \circ \langle \tilde{F}^{(m)} \rangle)(1) &\subset \sum_{\mathbf{i} \in \mathcal{I}(m,n)} \mathcal{F}'(\langle \tilde{F}^{\mathbf{i}} \rangle)(1). \end{aligned}$$

**Proof** The assertion follows from (9) and (10), by using induction on  $n \geq 1$ . □

Let  $B = b_4 \circ b_3 \circ b_2 \circ b_1$  with  $b = (b_1, b_2, b_3, b_4) \in \tilde{\Gamma}_g''$ . By the condition  $(C_{dk})$  in the definition of  $\Gamma_g''$ , we can write  $b_2 \circ b_1 = \sigma \circ \tilde{b}_1$  with  $\sigma \in \text{Hom}(\mathcal{A}_{\otimes})$  and

$$(43) \quad \tilde{b}_1 = \langle D^{\pm 1} \rangle^{\otimes l_1} \otimes \left( \bigotimes_{p=1}^{l_2} (\langle \Delta \rangle^{[m_p, n_p]} \circ \langle \Theta_{s_p} \rangle) \right) \otimes \langle \bar{U}_q^0 \rangle^{\otimes l_3},$$

for  $l_1, l_2, l_3 \geq 0, s_1, \dots, s_{l_2} \geq 0, m_1, \dots, m_{l_2}, n_1, \dots, n_{l_2} \geq 1$ . Note that

$$\left( \bigotimes_{p=1}^{l_2} (\langle \Delta \rangle^{[m_p, n_p]} \circ \langle \Theta_{s_p} \rangle) \right) = \bigotimes_{p=1}^{l_2} \left( \langle \{s_p\}_q! \rangle \otimes (\langle \Delta \rangle^{[m_p]} \circ \langle \tilde{F}^{(s_p)} \rangle) \otimes (\langle \Delta \rangle^{[n_p]} \circ \langle \tilde{E}^{(s_p)} \rangle) \right).$$

For  $\mathbf{i}_p \in \mathcal{I}(s_p, m_p)$  and  $\bar{\mathbf{i}}_p \in \mathcal{I}(s_p, n_p)$ ,  $p = 1, \dots, l_2$ , set

$$(44) \quad \tilde{b}_1(\mathbf{i}_1, \bar{\mathbf{i}}_1, \dots, \mathbf{i}_{l_2}, \bar{\mathbf{i}}_{l_2}) = \langle D^{\pm 1} \rangle^{\otimes l_1} \otimes \left( \bigotimes_{p=1}^{l_2} (\langle \{s_p\}_q! \rangle \otimes \langle \tilde{F}^{\mathbf{i}_p} \rangle \otimes \langle \tilde{E}^{\bar{\mathbf{i}}_p} \rangle) \right) \otimes \langle \bar{U}_q^0 \rangle^{\otimes l_3}.$$

In other words,  $\tilde{b}_1(\mathbf{i}_1, \bar{\mathbf{i}}_1, \dots, \mathbf{i}_{l_2}, \bar{\mathbf{i}}_{l_2})$  is obtained from  $\tilde{b}_1$  by replacing the  $\langle \Delta \rangle^{[m_p]} \circ \langle \tilde{F}^{(s_p)} \rangle$  with a  $\langle \tilde{F}^{\mathbf{i}_p} \rangle$ , and the  $\langle \Delta \rangle^{[n_p]} \circ \langle \tilde{E}^{(s_p)} \rangle$  with a  $\langle \tilde{E}^{\bar{\mathbf{i}}_p} \rangle$ , for  $p = 1, \dots, l_2$ ; see Figure 38.

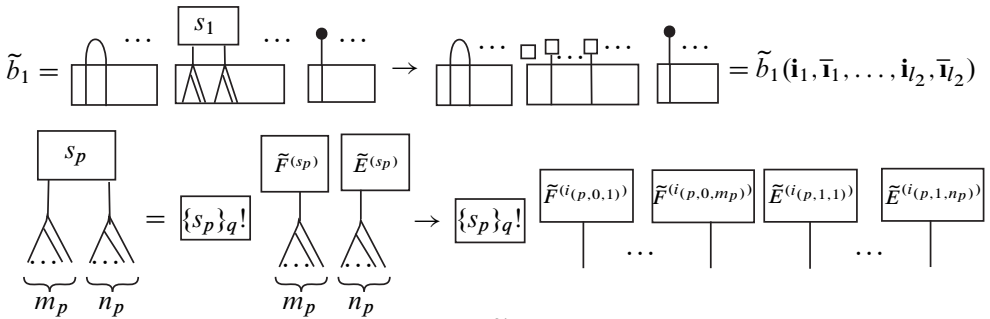

Figure 38. How to obtain  $\tilde{b}_1(\mathbf{i}_1, \bar{\mathbf{i}}_1, \dots, \mathbf{i}_{l_2}, \bar{\mathbf{i}}_{l_2})$  with  $\mathbf{i}_p = (i_{(p,0,1)}, \dots, i_{(p,0,m_p)}) \in \mathcal{I}(s_p, m_p)$ ,  $\bar{\mathbf{i}}_p = (i_{(p,1,1)}, \dots, i_{(p,1,n_p)}) \in \mathcal{I}(s_p, n_p)$  for  $p = 1, \dots, l_2$

By Lemma 5.15, we have

$$(45) \quad \mathcal{F}'(B)(1) \subset \sum_{\substack{\mathbf{i}_p \in \mathcal{I}(s_p, m_p) \\ \bar{\mathbf{i}}_p \in \mathcal{I}(s_p, n_p) \\ p=1, \dots, l_2}} \mathcal{F}'(b_4 \circ b_3 \circ \sigma \circ \tilde{b}_1(\mathbf{i}_1, \bar{\mathbf{i}}_1, \dots, \mathbf{i}_{l_2}, \bar{\mathbf{i}}_{l_2}))(1).$$

### 5.8 Proof of $\mathcal{F}'(\Gamma''_g)(1) \subset (\bar{U}_q^{\text{ev}})^{\otimes g}$

We prove the inclusion  $\mathcal{F}'(\Gamma''_g)(1) \subset (\bar{U}_q^{\text{ev}})^{\otimes g}$ . Let  $B = b_4 \circ b_3 \circ b_2 \circ b_1$  with  $(b_1, b_2, b_3, b_4) \in \Gamma''_g$  such that  $b_2 \circ b_1 = \sigma \circ \tilde{b}_1$  with  $\sigma \in \text{Hom}(\mathcal{A}_{\mathfrak{G}})$  and  $\tilde{b}_1$  as in (43). By (45), it is enough to prove

$$(46) \quad \mathcal{F}'(b_4 \circ b_3 \circ \sigma \circ \tilde{b}_1(\mathbf{i}_1, \bar{\mathbf{i}}_1, \dots, \mathbf{i}_{l_2}, \bar{\mathbf{i}}_{l_2}))(1) \subset (\bar{U}_q^{\text{ev}})^{\otimes g},$$

for  $\mathbf{i}_p \in \mathcal{I}(s_p, m_p)$ ,  $\bar{\mathbf{i}}_p \in \mathcal{I}(s_p, n_p)$ ,  $p = 1, \dots, l_2$ .

We prove (46). First, we study  $\mathcal{F}'(b_3 \circ \sigma \circ \tilde{b}_1(\mathbf{i}_1, \bar{\mathbf{i}}_1, \dots, \mathbf{i}_{l_2}, \bar{\mathbf{i}}_{l_2}))(1)$ . Fix

$$\mathbf{i}_p = (i_{(p,0,1)}, \dots, i_{(p,0,m_p)}) \in \mathcal{I}(s_p, m_p), \quad \bar{\mathbf{i}}_p = (i_{(p,1,1)}, \dots, i_{(p,1,n_p)}) \in \mathcal{I}(s_p, n_p),$$

for  $p = 1, \dots, l_2$ . On a diagram of  $\tilde{b}_1(\mathbf{i}_1, \bar{\mathbf{i}}_1, \dots, \mathbf{i}_{l_2}, \bar{\mathbf{i}}_{l_2})$ , we color the output edge of the  $\langle \tilde{F}^{(i_{(p,0,t)})} \rangle$  (resp.  $\langle \tilde{E}^{(i_{(p,1,u)})} \rangle$ ) with a label  $(p, 0, t)$  (resp.  $(p, 1, u)$ ) for  $t = 1, \dots, m_p$  (resp.  $u = 1, \dots, n_p$ ),  $p = 1, \dots, l_2$ ; see Figure 39(a). We also color the output edges of the  $\langle \bar{U}_q^0 \rangle$ 's in  $\tilde{b}_1(\mathbf{i}_1, \bar{\mathbf{i}}_1, \dots, \mathbf{i}_l, \bar{\mathbf{i}}_l)$  with symbols  $k_1, \dots, k_{l_3}$  from the left to right; see Figure 39(b). Let  $\mathcal{P}$  be the set of the all labels, ie, set

$$\mathcal{P} = \{(p, 0, t) \mid 1 \leq t \leq m_p, 1 \leq p \leq l_2\} \sqcup \{(p, 1, u) \mid 1 \leq u \leq n_p, 1 \leq p \leq l_2\} \sqcup \{k_1, \dots, k_{l_3}\}.$$

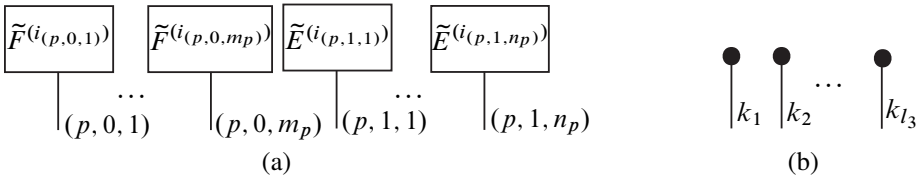

Figure 39. How to color the output edges of  $\tilde{b}_1(\mathbf{i}_1, \bar{\mathbf{i}}_1, \dots, \mathbf{i}_{l_2}, \bar{\mathbf{i}}_{l_2})$

In what follows, since  $\mathcal{F}'(\langle \bar{U}_q^0 \rangle)(1) = \mathcal{F}'(\langle \tilde{E}^{(0)} \rangle)(1) = \bar{U}_q^0$ , we identify  $\langle \bar{U}_q^0 \rangle$  with  $\langle \tilde{E}^{(0)} \rangle$ , and set  $i_{k_j} = 0$  for  $j = 1, \dots, l_3$ ; see Figure 40. We call the diagram of  $\langle \tilde{X}^{(i)} \rangle$  for  $i \geq 0$  with  $X \in \{E, F\}$  an  $X$ -box.

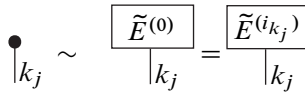

Figure 40. How to treat the  $j$ -th  $\langle \bar{U}_q^0 \rangle$  for  $j = 1, \dots, l_3$

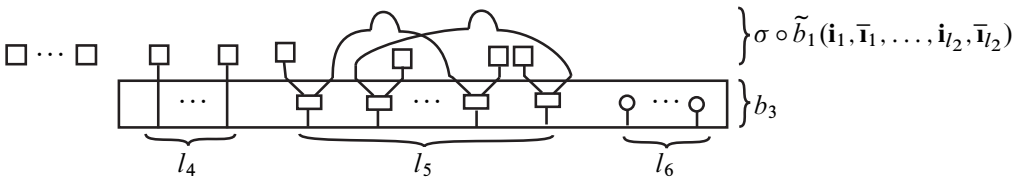

Figure 41. How to arrange the diagram of  $b_3 \circ \sigma \circ \tilde{b}_1(\mathbf{i}_1, \bar{\mathbf{i}}_1, \dots, \mathbf{i}_{l_2}, \bar{\mathbf{i}}_{l_2})$

After we color the edges, we arrange the diagram of  $b_3 \circ \sigma \circ \tilde{b}_1(\mathbf{i}_1, \bar{\mathbf{i}}_1, \dots, \mathbf{i}_{l_2}, \bar{\mathbf{i}}_{l_2})$  keeping  $b_3$  so that each  $X$ -box is connected to  $b_3$  directly without any crossings as in Figure 41, where we set  $b_3 = \text{id}_A^{\otimes l_4} \otimes \langle \dot{Y} \rangle^{\otimes l_5} \otimes \langle \bar{U}_q^{\text{ev}0} \rangle^{\otimes l_6}$ , and the floating boxes is the diagrams of  $\langle \{s_p\}_q! \rangle$  for  $p = 1, \dots, l_2$ . Here, by the condition  $(C_{\text{ad}})$  in the

definition of  $\Gamma''_g$ , the first  $l_4$  input edges of  $b_3$  are connected to  $X$ -boxes, and by the condition  $(C_Y)$ , at least one of the input edges of each  $\langle \dot{Y} \rangle$  in  $b_3$  is connected to an  $X$ -box. Note that there are five cases as depicted in Figure 42(c1)–(c5), how a  $\langle \dot{Y} \rangle$  is connected to the  $X$ -boxes and the  $\langle D^{\pm 1} \rangle$ 's.

Thus, we have

$$(47) \quad b_3 \circ \sigma \circ \tilde{b}_1(\mathbf{i}_1, \bar{\mathbf{1}}_1, \dots, \mathbf{i}_{l_2}, \bar{\mathbf{1}}_{l_2}) \\ = \bigotimes_{p=1}^{l_2} \langle \{s_p\}q! \rangle \otimes \langle \tilde{X}_1^{(i_{a(1)})} \rangle \otimes \dots \otimes \langle \tilde{X}_{l_4}^{(i_{a(l_4)})} \rangle \otimes Z \otimes \langle \bar{U}_q^{\text{ev}0} \rangle^{\otimes l_6},$$

for  $a(1), \dots, a(l_4) \in \mathcal{P}$ ,  $X_1, \dots, X_{l_4} \in \{E, F\}$ , and  $Z \in \langle \dot{Y} \rangle^{\otimes l_5} \circ \text{Hom}_{\mathcal{A}}(I, A^{\otimes 2l_5})$ .

For  $j = 1, \dots, l_4$ , we call the label  $a(j)$  *isolated*. We say the labels  $a$  and  $b$  as in Figure 42(c1)–(c5) are *adjacent* to each other.

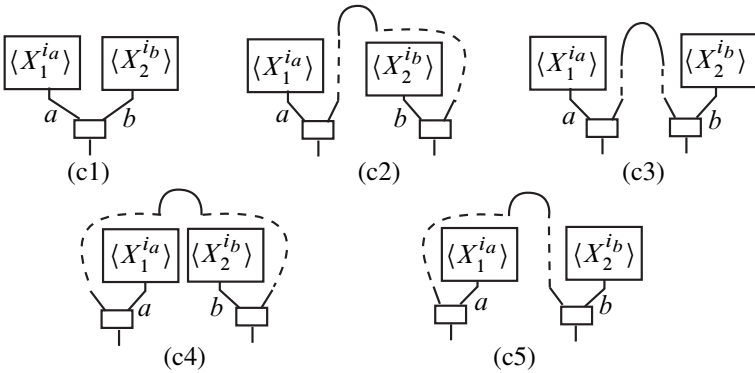

Figure 42. The  $\langle \dot{Y} \rangle$ 's in  $b_3$ , where  $X_1, X_2 \in \{E, F\}$  and  $a, b \in \mathcal{P}$

Note that the identity (47) implies

$$(48) \quad \mathcal{F}'(b_3 \circ \sigma \circ \tilde{b}_1(\mathbf{i}_1, \bar{\mathbf{1}}_1, \dots, \mathbf{i}_{l_2}, \bar{\mathbf{1}}_{l_2}))(1) \\ \subset \left( \prod_{p=1}^{l_2} \langle \{s_p\}q! \rangle \right) \cdot (U_{\mathbb{Z}, q}^{\otimes l_4} \otimes \mathcal{F}'(Z)(1) \otimes \langle \bar{U}_q^{\text{ev}0} \rangle^{\otimes l_6}).$$

Let us consider  $\sum z_1 \otimes \dots \otimes z_{l_5} \in \mathcal{F}'(Z)(1)$ . If the  $m$ -th  $\langle \dot{Y} \rangle$  (from the left in  $b_3$ ) is as in (c1), then we can assume  $z_m \in \dot{Y}(\bar{U}_q^0 \tilde{X}_1^{(i_a)} \otimes \bar{U}_q^0 \tilde{X}_2^{(i_b)})$ . By Lemma 3.9, we have

$$(49) \quad \dot{Y}(\bar{U}_q^0 \tilde{X}_1^{(i_a)} \otimes \bar{U}_q^0 \tilde{X}_2^{(i_b)}) \subset (\{\min(i_a, i_b)\}q!)^{-1} \cdot \bar{U}_q^{\text{ev}},$$

where  $(\{\min(i, j)\}_q!)^{-1} \cdot \bar{U}_q^{\text{ev}} \subset \bar{U}_q^{\text{ev}} \otimes_{\mathbb{Z}[q, q^{-1}]} \mathbb{Q}(q)$ . For example, we have

$$\begin{aligned} \dot{Y}(\bar{U}_q^0 \tilde{E}^{(2)} \otimes \bar{U}_q^0 \tilde{F}^{(3)}) &= (\{2\}_q!)^{-1} \dot{Y}(\bar{U}_q^0 e^2 \otimes \bar{U}_q^0 \tilde{F}^{(3)}) \\ &\subset (\{2\}_q!)^{-1} \bar{U}_q^{\text{ev}}. \end{aligned}$$

If the  $m$ -th and the  $n$ -th  $\langle \dot{Y} \rangle$ 's are as in (c2), then we can assume

$$\sum z_m \otimes z_n \in \sum \dot{Y}(\bar{U}_q^0 \tilde{X}_1^{(i_a)} \otimes \bar{U}_q^0 D'_\pm) \otimes \dot{Y}(\bar{U}_q^0 \tilde{X}_2^{(i_b)} \otimes \bar{U}_q^0 D''_\pm).$$

By Lemma 3.10, we have

$$\begin{aligned} (50) \quad \sum \dot{Y}(\bar{U}_q^0 \tilde{X}_1^{(i_a)} \otimes \bar{U}_q^0 D'_\pm) \otimes \dot{Y}(\bar{U}_q^0 \tilde{X}_2^{(i_b)} \otimes \bar{U}_q^0 D''_\pm) \\ \subset (\{\min(i_a, i_b)\}_q!)^{-1} \cdot (\bar{U}_q^{\text{ev}})^{\otimes 2}. \end{aligned}$$

Similarly, for (c3), (c4), (c5), we have

$$\begin{aligned} (51) \quad \sum \dot{Y}(\bar{U}_q^0 \tilde{X}_1^{(i_a)} \otimes \bar{U}_q^0 D'_\pm) \otimes \dot{Y}(\bar{U}_q^0 D''_\pm \otimes \bar{U}_q^0 \tilde{X}_2^{(i_b)}) \\ \subset (\{\min(i_a, i_b)\}_q!)^{-1} \cdot (\bar{U}_q^{\text{ev}})^{\otimes 2}, \end{aligned}$$

$$\begin{aligned} (52) \quad \sum \dot{Y}(\bar{U}_q^0 D'_\pm \otimes \bar{U}_q^0 \tilde{X}_1^{(i_a)}) \otimes \dot{Y}(\bar{U}_q^0 \tilde{X}_2^{(i_b)} \otimes \bar{U}_q^0 D''_\pm) \\ \subset (\{\min(i_a, i_b)\}_q!)^{-1} \cdot (\bar{U}_q^{\text{ev}})^{\otimes 2}, \end{aligned}$$

$$\begin{aligned} (53) \quad \sum \dot{Y}(\bar{U}_q^0 D'_\pm \otimes \bar{U}_q^0 \tilde{X}_1^{(i_a)}) \otimes \dot{Y}(\bar{U}_q^0 D''_\pm \otimes \bar{U}_q^0 \tilde{X}_2^{(i_b)}) \\ \subset (\{\min(i_a, i_b)\}_q!)^{-1} \cdot (\bar{U}_q^{\text{ev}})^{\otimes 2}, \end{aligned}$$

respectively.

Let  $\mathcal{P}_A^2$  denote the set of unordered pairs  $\{a, b\}$  of mutually adjacent elements  $a, b \in \mathcal{P}$ . By the above inclusions (49)–(52), we have

$$\sum z_1 \otimes \cdots \otimes z_{l_5} \in \left( \prod_{\{a, b\} \in \mathcal{P}_A^2} (\{\min(i_a, i_b)\}_q!)^{-1} \right) \cdot (\bar{U}_q^{\text{ev}})^{\otimes l_5}.$$

Thus, by (48), we have

$$\begin{aligned} (54) \quad \mathcal{F}'(b_3 \circ \sigma \circ \tilde{b}_1(\mathbf{i}_1, \bar{\mathbf{i}}_1, \dots, \mathbf{i}_l, \bar{\mathbf{i}}_l))(1) &\subset I \cdot (U_{\mathbb{Z}, q}^{\otimes l_4} \otimes (\bar{U}_q^{\text{ev}})^{\otimes l_5} \otimes (\bar{U}_q^{\text{ev}0})^{\otimes l_6}) \\ &\subset I \cdot (U_{\mathbb{Z}, q}^{\otimes l_4} \otimes (\bar{U}_q^{\text{ev}})^{\otimes l_5 + l_6}), \end{aligned}$$

where we set

$$I = \left( \prod_{p=1}^{l_2} \{s_p\}_q! \right) \cdot \left( \prod_{\{a, b\} \in \mathcal{P}_A^2} (\{\min(i_a, i_b)\}_q!)^{-1} \right) \in \mathbb{Q}(q).$$



Let us study  $\mathcal{F}'(b_4)(U_{\mathbb{Z},q}^{\otimes l_4} \otimes (\bar{U}_q^{\text{ev}})^{\otimes l_5+l_6})$ . Since the first  $l_4$  input edges of  $b_4$  are connected to the left (resp. right) input edges of the  $\langle \text{ad} \rangle$ 's (resp.  $\langle \bar{\text{ad}} \rangle$ 's), and the next  $l_5 + l_6$  input edges of  $b_4$  go down to the edges of the  $\langle \mu \rangle$ 's and to the right (resp. left) input edges of the  $\langle \text{ad} \rangle$ 's (resp.  $\langle \bar{\text{ad}} \rangle$ 's), by Proposition 2.2, (resp. Corollary 2.3) we have

$$(55) \quad \mathcal{F}'(b_4)(U_{\mathbb{Z},q}^{\otimes l_4} \otimes (\bar{U}_q^{\text{ev}})^{\otimes l_5+l_6}) \subset (\bar{U}_q^{\text{ev}})^{\otimes g}.$$

By (54) and (55), we have

$$\mathcal{F}'(b_4 \circ b_3 \circ \sigma \circ \tilde{b}_1(\mathbf{i}_1, \bar{\mathbf{1}}_1, \dots, \mathbf{i}_{l_2}, \bar{\mathbf{1}}_{l_2}))(1) \subset I \cdot (\bar{U}_q^{\text{ev}})^{\otimes g}.$$

Thus, for the proof of (46), it is enough to prove

$$(56) \quad I \in \mathbb{Z}[q, q^{-1}].$$

For  $k \geq 1$ , let  $\Phi_k(q)$  be the  $k$ -th cyclotomic polynomial in  $q$ . For  $f(q) \in \mathbb{Z}[q, q^{-1}]$ ,  $f(q) \neq 0$ , let  $d_k(f(q))$  be the largest integer  $i$  such that  $f(q) \in \Phi_k^i(q)\mathbb{Z}[q, q^{-1}]$ . Since both  $\prod_{p=1}^{l_2} \{s_p\}_q!$  and  $\prod_{\{a,b\} \in \mathcal{P}_\Lambda^2} \{\min(i_a, i_b)\}_q!$  are products of the cyclotomic polynomials, in order to prove (56), it is enough to prove

$$(57) \quad d_k \left( \prod_{p=1}^{l_2} \{s_p\}_q! \right) \geq d_k \left( \prod_{\{a,b\} \in \mathcal{P}_\Lambda^2} \{\min(i_a, i_b)\}_q! \right)$$

for  $k \geq 1$ .

We prove (57). Fix  $k \geq 1$ . Since we have

$$d_k(\{i\}_q) = d_k(q^i - 1) = \begin{cases} 1 & \text{if } k|i, \\ 0 & \text{otherwise,} \end{cases}$$

for  $i \geq 0$ , it follows that

$$d_k(\{i\}_q!) = \lfloor i/k \rfloor.$$

This identity and  $s_p = \sum_{t=1}^{m_p} i_{(p,0,t)} = \sum_{u=1}^{n_p} i_{(p,1,u)}$  imply

$$\begin{aligned} d_k(\{s_p\}_q!) &\geq \sum_{t=1}^{m_p} d_k(\{i_{(p,0,t)}\}_q!), \\ d_k(\{s_p\}_q!) &\geq \sum_{u=1}^{n_p} d_k(\{i_{(p,1,u)}\}_q!). \end{aligned}$$

Thus, we have

$$\begin{aligned}
 d_k \left( \prod_{p=1}^{l_2} \{s_p\}_q! \right) &\geq \sum_{p=1}^{l_2} \left( \sum_{t=1}^{m_p} d_k(\{i_{(p,0,t)}\}_q!) + \sum_{u=1}^{n_p} d_k(\{i_{(p,1,u)}\}_q!) \right) / 2 \\
 &= \sum_{a \in \mathcal{P}} d_k(\{i_a\}_q!) / 2 \\
 &= \left( \sum_{\{a,b\} \in \mathcal{P}_\Lambda^2} d_k(\{i_a\}_q! \{i_b\}_q!) + \sum_{c \in \mathcal{P}_{\text{iso}}} d_k(\{i_c\}_q!) \right) / 2 \\
 &\geq \sum_{\{a,b\} \in \mathcal{P}_\Lambda^2} d_k(\{i_a\}_q! \{i_b\}_q!) / 2 \\
 &= d_k \left( \prod_{\{a,b\} \in \mathcal{P}_\Lambda^2} \{i_a\}_q! \{i_b\}_q! \right) / 2 \\
 &\geq d_k \left( \prod_{\{a,b\} \in \mathcal{P}_\Lambda^2} \{\min(i_a, i_b)\}_q! \right),
 \end{aligned}$$

where  $\mathcal{P}_{\text{iso}} \subset \mathcal{P}$  denotes the subset consisting of isolated labels. This completes the proof.

## 6 Completions

In this section, we define the completion  $(\bar{U}_q^{\text{ev}})^{\widehat{\otimes} n}$  of  $(\bar{U}_q^{\text{ev}})^{\otimes n}$ , and prove [Theorem 1.2](#).

### 6.1 Filtrations of $\bar{U}_q^{\text{ev}}$ with respect to $\text{ad}$ and $\overline{\text{ad}}$

For a subset  $X \subset \bar{U}_q^{\text{ev}}$ , let  $\langle X \rangle_{\text{ideal}}$  denote the two-sided ideal of  $\bar{U}_q^{\text{ev}}$  generated by  $X$ . Set

$$\begin{aligned}
 A_p &= \langle U_{\mathbb{Z},q} \triangleright e^p \rangle_{\text{ideal}}, \\
 C_p &= \left\langle \sum_{p' \geq p} (U_{\mathbb{Z},q} \tilde{E}^{(p')} \triangleright \bar{U}_q^{\text{ev}}) \right\rangle_{\text{ideal}}, & C'_p &= \left\langle \sum_{p' \geq p} (U_{\mathbb{Z},q} \tilde{F}^{(p')} \triangleright \bar{U}_q^{\text{ev}}) \right\rangle_{\text{ideal}}, \\
 \tilde{C}_p &= \left\langle \sum_{p' \geq p} K(U_{\mathbb{Z},q} \tilde{E}^{(p')} \triangleright K\bar{U}_q^{\text{ev}}) \right\rangle_{\text{ideal}}, & \tilde{C}'_p &= \left\langle \sum_{p' \geq p} K(U_{\mathbb{Z},q} \tilde{F}^{(p')} \triangleright K\bar{U}_q^{\text{ev}}) \right\rangle_{\text{ideal}},
 \end{aligned}$$

for  $p \geq 0$ . For  $X = A, C, C', \tilde{C}, \tilde{C}'$ , the  $X_p, p \geq 0$ , form a decreasing filtration of  $\bar{U}_q^{\text{ev}}$ , ie, we have  $X_p \supset X_{p+1}$  for  $p \geq 0$ .

**Lemma 6.1** [23, Proposition 5.5]

- (i) For  $p \geq 0$ , we have  $C_p = C'_p$ .
- (ii) For  $p \geq 0$ , we have  $C_{2p} \subset A_p$ .
- (iii) If  $p \geq 0$  is even, then we have  $C_{2p} = A_p$ .

**Lemma 6.2**

- (i) For  $p \geq 0$ , we have  $\tilde{C}_p = \tilde{C}'_p$ .
- (ii) For  $p \geq 0$ , we have  $\tilde{C}_{2p} \subset A_p$ .
- (iii) If  $p \geq 0$  is odd, then we have  $\tilde{C}_{2p} = A_p$ .

**Proof** The proof is almost the same as that of Lemma 6.1. □

For  $p \geq 0$ , set

$$G_p = C_p + \tilde{C}_p = C'_p + \tilde{C}'_p.$$

**Corollary 6.3** For  $p \geq 0$ , we have  $G_{2p} = A_p$ .

**Proof** For  $p \geq 0$ , by Lemma 6.1(ii) and Lemma 6.2(ii), we have  $G_{2p} \subset A_p$ .

If  $p \geq 0$  is even, then by Lemma 6.1(iii), we have  $G_{2p} \supset C_{2p} = A_p$ .

If  $p \geq 0$  is odd, then by Lemma 6.2(iii), we have  $G_{2p} \supset \tilde{C}_{2p} = A_p$ .

Thus, we have the assertion. □

**Corollary 6.4** The filtrations  $\{A_p\}_{p \geq 0}$ ,  $\{C_p\}_{p \geq 0}$ ,  $\{\tilde{C}_p\}_{p \geq 0}$ ,  $\{G_p\}_{p \geq 0}$  are all cofinal with each other.

### 6.2 Filtrations of $\bar{U}_q^{\text{ev}}$ and $(\bar{U}_q^{\text{ev}})^{\otimes 2}$ with respect to $\dot{Y}$

For  $p \geq 0$ , let  $\mathcal{Y}_p$  be the two-sided ideal in  $\bar{U}_q^{\text{ev}}$  generated by the elements in

$$\begin{aligned} \sum_{p' \geq p} \dot{Y}(\bar{U}_q^0 \tilde{E}^{(p')} \otimes \bar{U}_q), & \quad \sum_{p' \geq p} \dot{Y}(\bar{U}_q \otimes \bar{U}_q^0 \tilde{E}^{(p')}), \\ \sum_{p' \geq p} \dot{Y}(\bar{U}_q^0 \tilde{F}^{(p')} \otimes \bar{U}_q), & \quad \sum_{p' \geq p} \dot{Y}(\bar{U}_q \otimes \bar{U}_q^0 \tilde{F}^{(p')}). \end{aligned}$$

**Lemma 6.5** For  $p \geq 0$ , we have  $\mathcal{Y}_p \subset G_p$ .

**Proof** It is enough to prove that all the generators of  $\mathcal{Y}_p$  are contained in  $G_p$ .

By (18), (20), and (25), we have

$$\begin{aligned} \dot{Y}(\bar{U}_q^0 \tilde{E}^{(p')} \otimes \bar{U}_q) &\subset \sum_{i=0,1} (\bar{U}_q^0 \tilde{E}^{(p')} \triangleright K^i \bar{U}_q^{\text{ev}}) K^i \bar{U}_q^{\text{ev}} \subset C_p + \tilde{C}_p \subset G_p, \\ \dot{Y}(\bar{U}_q \otimes \bar{U}_q^0 \tilde{E}^{(p')}) &= \sum_{i=0,1} K^i \bar{U}_q^{\text{ev}} (S^{-1}(\bar{U}_q^0 \tilde{E}^{(p')}) \triangleright K^i \bar{U}_q^{\text{ev}}) \\ &\subset \sum_{i=0,1} K^i \bar{U}_q^{\text{ev}} (\bar{U}_q^0 \tilde{E}^{(p')} \triangleright K^i \bar{U}_q^{\text{ev}}) \subset C_p + \tilde{C}_p \subset G_p, \end{aligned}$$

for  $p' \geq p$ . Similarly, we have

$$\begin{aligned} \dot{Y}(\bar{U}_q^0 \tilde{F}^{(p')} \otimes \bar{U}_q) &\subset C'_p + \tilde{C}'_p \subset G_p, \\ \dot{Y}(\bar{U}_q \otimes \bar{U}_q^0 \tilde{F}^{(p')}) &\subset C'_p + \tilde{C}'_p \subset G_p, \end{aligned}$$

for  $p' \geq p$ . Hence we have the assertion. □

Let  $(\mathcal{Y}^D)_p$  be the two-sided ideal in  $(\bar{U}_q^{\text{ev}})^{\otimes 2}$  generated by the elements in

$$\begin{aligned} &\sum_{p' \geq p} \dot{Y}(\bar{U}_q^0 \tilde{E}^{(p')} \otimes \bar{U}_q^0 D'_\pm) \otimes \dot{Y}(\bar{U}_q \otimes \bar{U}_q^0 D''_\pm), \\ &\sum_{p' \geq p} \dot{Y}(\bar{U}_q^0 \tilde{F}^{(p')} \otimes \bar{U}_q^0 D'_\pm) \otimes \dot{Y}(\bar{U}_q \otimes \bar{U}_q^0 D''_\pm), \\ &\sum_{p' \geq p} \dot{Y}(\bar{U}_q^0 \tilde{E}^{(p')} \otimes \bar{U}_q^0 D'_\pm) \otimes \dot{Y}(\bar{U}_q^0 D''_\pm \otimes \bar{U}_q), \\ &\sum_{p' \geq p} \dot{Y}(\bar{U}_q^0 \tilde{F}^{(p')} \otimes \bar{U}_q^0 D'_\pm) \otimes \dot{Y}(\bar{U}_q^0 D''_\pm \otimes \bar{U}_q), \\ &\sum_{p' \geq p} \dot{Y}(\bar{U}_q^0 D'_\pm \otimes \bar{U}_q^0 \tilde{E}^{(p')}) \otimes \dot{Y}(\bar{U}_q \otimes \bar{U}_q^0 D''_\pm), \\ &\sum_{p' \geq p} \dot{Y}(\bar{U}_q^0 D'_\pm \otimes \bar{U}_q^0 \tilde{F}^{(p')}) \otimes \dot{Y}(\bar{U}_q \otimes \bar{U}_q^0 D''_\pm), \\ &\sum_{p' \geq p} \dot{Y}(\bar{U}_q^0 D'_\pm \otimes \bar{U}_q^0 \tilde{E}^{(p')}) \otimes \dot{Y}(\bar{U}_q^0 D''_\pm \otimes \bar{U}_q), \\ &\sum_{p' \geq p} \dot{Y}(\bar{U}_q^0 D'_\pm \otimes \bar{U}_q^0 \tilde{F}^{(p')}) \otimes \dot{Y}(\bar{U}_q^0 D''_\pm \otimes \bar{U}_q). \end{aligned}$$

Note that these sets are all contained in  $(\bar{U}_q^{\text{ev}})^{\otimes 2}$  by Lemma 3.10.

### 6.3 Filtrations of $(\bar{U}_q^{\text{ev}})^{\otimes n}$

For  $n \geq 1$  and a filtration  $\{X_p\}_{p \geq 0}$  of  $\bar{U}_q^{\text{ev}}$ , define a filtration  $\{X_p^{(n)}\}_{p \geq 0}$  of  $(\bar{U}_q^{\text{ev}})^{\otimes n}$  by

$$X_p^{(n)} = \sum_{j=1}^n (\bar{U}_q^{\text{ev}})^{\otimes j-1} \otimes X_p \otimes (\bar{U}_q^{\text{ev}})^{\otimes n-j}.$$

For  $n \geq 1$ , define the filtration  $\{(\mathcal{Y}^D)_p^{(n)}\}_{p \geq 0}$  of  $(\bar{U}_q^{\text{ev}})^{\otimes n}$  by

$$\begin{aligned} (\mathcal{Y}^D)_p^{(n)} = & \left\{ \sum_{1 \leq i < j \leq n} (\bar{U}_q^{\text{ev}})^{\otimes i-1} \otimes y' \otimes (\bar{U}_q^{\text{ev}})^{\otimes j-i-1} \otimes y'' \otimes (\bar{U}_q^{\text{ev}})^{\otimes n-j} \mid \right. \\ & \left. \sum y' \otimes y'' \in (\mathcal{Y}^D)_p \right\} \\ & + \left\{ \sum_{1 \leq i < j \leq n} (\bar{U}_q^{\text{ev}})^{\otimes i-1} \otimes y'' \otimes (\bar{U}_q^{\text{ev}})^{\otimes j-i-1} \otimes y' \otimes (\bar{U}_q^{\text{ev}})^{\otimes n-j} \mid \right. \\ & \left. \sum y' \otimes y'' \in (\mathcal{Y}^D)_p \right\} \\ & + \left\{ \sum_{k=1}^n (\bar{U}_q^{\text{ev}})^{\otimes k-1} \otimes y' y'' \otimes (\bar{U}_q^{\text{ev}})^{\otimes n-k} \mid \sum y' \otimes y'' \in (\mathcal{Y}^D)_p \right\} \\ & + \left\{ \sum_{k=1}^n (\bar{U}_q^{\text{ev}})^{\otimes k-1} \otimes y'' y' \otimes (\bar{U}_q^{\text{ev}})^{\otimes n-k} \mid \sum y' \otimes y'' \in (\mathcal{Y}^D)_p \right\}. \end{aligned}$$

**Lemma 6.6** For  $n \geq 1, p \geq 0$ , we have  $(\mathcal{Y}^D)_p^{(n)} \subset G_{\lfloor p/2 \rfloor}^{(n)}$ .

**Proof** It is enough to prove that all the generators of  $(\mathcal{Y}^D)_p$  are contained in  $G_{\lfloor p/2 \rfloor}^{(2)}$ .

We prove

$$\sum_{p' \geq p} \dot{Y}(\bar{U}_q^0 \tilde{E}^{(p')} \otimes \bar{U}_q^0 D') \otimes \dot{Y}(\bar{U}_q^0 D'' \otimes \bar{U}_q) \subset G_{\lfloor p/2 \rfloor}^{(2)}.$$

Similarly for the other generators of  $(\mathcal{Y}^D)_p$ . For  $p \geq 0$ , let us assume a weaker inclusion

$$(58) \quad \sum \dot{Y}(\bar{U}_q^0 \tilde{E}^{(p)} \otimes D') \otimes \dot{Y}(D'' \otimes \bar{U}_q) \subset G_p^{(2)}.$$

Then, similarly to (34), for  $p' \geq p$ , we have

$$\begin{aligned}
 & \sum \dot{Y}(\bar{U}_q^0 \tilde{E}^{(p')}) \otimes \bar{U}_q^0 D' \otimes \dot{Y}(\bar{U}_q^0 D'' \otimes \bar{U}_q) \\
 &= \sum \dot{Y}(\bar{U}_q^0 \tilde{E}^{(p')}) \otimes D' \bar{U}_q^0 \otimes \dot{Y}(\bar{U}_q^0 D'' \otimes \bar{U}_q) \\
 &\subset \sum \dot{Y}((\bar{U}_q^0 \tilde{E}^{(p')})_{(1)} \otimes \bar{U}_q^0) (\dot{Y}((\bar{U}_q^0 \tilde{E}^{(p')})_{(2)} \otimes D') \triangleleft \bar{U}_q^0) \\
 &\hspace{20em} \otimes (\bar{U}_q^0 \triangleright \dot{Y}(D'' \otimes \bar{U}_q)) \dot{Y}(\bar{U}_q^0 \otimes \bar{U}_q) \\
 &\subset \sum \dot{Y}((\bar{U}_q^0 \tilde{E}^{(p')})_{(1)} \otimes \bar{U}_q^0) \dot{Y}((\bar{U}_q^0 \tilde{E}^{(p')})_{(2)} \otimes D') \otimes \dot{Y}(D'' \otimes \bar{U}_q) \dot{Y}(\bar{U}_q^0 \otimes \bar{U}_q) \\
 &= \sum_{p'_1+p'_2=p'} \dot{Y}(\bar{U}_q^0 \tilde{E}^{(p'_1)} \otimes \bar{U}_q^0) \dot{Y}(\bar{U}_q^0 \tilde{E}^{(p'_2)} \otimes D') \otimes \dot{Y}(D'' \otimes \bar{U}_q) \dot{Y}(\bar{U}_q^0 \otimes \bar{U}_q) \\
 &\subset \sum_{p'_1+p'_2=p'} (\mathcal{Y}_{p'_1} \cdot \dot{Y}(\bar{U}_q^0 \tilde{E}^{(p'_2)} \otimes D')) \otimes (\dot{Y}(D'' \otimes \bar{U}_q) \cdot \bar{U}_q^{\text{ev}}) \\
 &\subset \sum_{p'_1+p'_2=p'} \mathcal{Y}_{p'_1}^{(2)} \cdot (\dot{Y}(\bar{U}_q^0 \tilde{E}^{(p'_2)} \otimes D') \otimes \dot{Y}(D'' \otimes \bar{U}_q) \cdot \bar{U}_q^{\text{ev}}) \\
 &\subset \sum_{p'_1+p'_2=p'} \mathcal{Y}_{p'_1}^{(2)} \cdot G_{p'_2}^{(2)} \\
 &\subset \sum_{p'_1+p'_2=p'} G_{p'_1}^{(2)} \cdot G_{p'_2}^{(2)} \subset \sum_{p'_1+p'_2=p'} G_{\max(p'_1, p'_2)}^{(2)} \subset G_{\lfloor p'/2 \rfloor}^{(2)} \subset G_{\lfloor p/2 \rfloor}^{(2)}.
 \end{aligned}$$

Here, the first inclusion follows from Lemma 3.7 and the fifth from (58).

Now, we prove (58). Similar to (35), for  $b \in \bar{U}_q$  homogeneous, we have

$$\sum \dot{Y}(\bar{U}_q^0 \tilde{E}^{(p)} \otimes D') \otimes \dot{Y}(D'' \otimes b) = \sum (\bar{U}_q^0 \tilde{E}^{(p)} \triangleright K^{-|b_{(2)}|}) K^{|b_{(2)}|} \otimes S^{-1}(b_{(2)}) b_{(1)},$$

with  $b_{(1)}, b_{(2)} \in \bar{U}_q$  homogeneous such that  $S^{-1}(b_{(1)}) b_{(2)} \in \bar{U}_q^{\text{ev}}$ .

If  $|b_{(2)}| \in 2\mathbb{Z}$ , then we have

$$(\bar{U}_q^0 \tilde{E}^{(p)} \triangleright K^{-|b_{(2)}|}) K^{|b_{(2)}|} \subset C_p \subset G_p.$$

If  $|b_{(2)}| \in \mathbb{Z} \setminus 2\mathbb{Z}$ , then we have

$$(\bar{U}_q^0 \tilde{E}^{(p)} \triangleright K^{-|b_{(2)}|}) K^{|b_{(2)}|} \subset \tilde{C}_p \subset G_p.$$

Thus, we have

$$\sum (\bar{U}_q^0 \tilde{E}^{(p)} \triangleright K^{-|b_{(2)}|}) K^{|b_{(2)}|} \otimes S^{-1}(b_{(2)}) b_{(1)} \subset G_p \otimes \bar{U}_q^{\text{ev}} \subset G_p^{(2)}.$$

Hence we have the assertion. □

### 6.4 Completions

Let  $(\bar{U}_q^{\text{ev}})^\wedge$  denote the completion of  $\bar{U}_q^{\text{ev}}$  in  $U_h$  with respect to the filtration  $\{G_p\}_{p \geq 0}$ , ie,  $(\bar{U}_q^{\text{ev}})^\wedge$  is the image of the map

$$\varprojlim_p (\bar{U}_q^{\text{ev}} / G_p) \rightarrow U_h$$

induced by the inclusion  $\bar{U}_q^{\text{ev}} \subset U_h$ . Since  $G_{2p} = A_p \subset h^p U_h$ , this map is well-defined.

Let  $(\bar{U}_q^{\text{ev}})^\wedge^{\widehat{\otimes} n}$  denote the completion of  $(\bar{U}_q^{\text{ev}})^{\otimes n}$  in  $U_h^{\widehat{\otimes} n}$  with respect to the filtration  $\{G_p^{(n)}\}_{p \geq 0}$ . For  $n = 0$ , it is natural to set

$$G_p^{(0)} = \begin{cases} \mathbb{Z}[q, q^{-1}] & \text{if } p = 0, \\ 0 & \text{if } p > 0. \end{cases}$$

Thus, we have

$$(\bar{U}_q^{\text{ev}})^\wedge^{\widehat{\otimes} 0} = \mathbb{Z}[q, q^{-1}].$$

### 6.5 Proof of Theorem 1.2

Let  $T \in BT_n$  be a boundary bottom tangle and  $(\tilde{T}; g_1, \dots, g_n)$  a boundary data for  $T$ . Let  $C(\tilde{T}) = \{c_1, \dots, c_l\}$  be the set of crossings of the diagram of  $\tilde{T}$  which we fix in the definition of  $J_{\tilde{T}}$ . We fix this notation in this section.

By Proposition 3.11, we have

$$\mu^{[g_1, \dots, g_n]} \bar{Y}^{\otimes g}(J_{\tilde{T}, s}) \in (\bar{U}_q^{\text{ev}})^{\otimes n},$$

for  $s \in \mathcal{S}(\tilde{T})$ . In this section, we prove Theorem 1.2, ie,

$$J_T = \sum_{s \in \mathcal{S}(\tilde{T})} \mu^{[g_1, \dots, g_n]} \bar{Y}^{\otimes g}(J_{\tilde{T}, s}) \in (\bar{U}_q^{\text{ev}})^\wedge^{\widehat{\otimes} n}.$$

It is enough to prove the following lemma.

**Lemma 6.7** *For each  $p \geq 0$ , there are only finitely many states  $s \in \mathcal{S}(\tilde{T})$  such that  $\mu^{[g_1, \dots, g_n]} \bar{Y}^{\otimes g}(J_{\tilde{T}, s}) \notin G_p^{(n)}$ .*

Since  $\mu^{[g_1, \dots, g_n]}(G_p^{(g)}) \subset G_p^{(n)}$  for  $p \geq 0$ , we have only to prove Lemma 6.7 replacing  $\mu^{[g_1, \dots, g_n]} \bar{Y}^{\otimes g}(J_{\tilde{T}, s}) \notin G_p^{(n)}$  with  $\bar{Y}^{\otimes g}(J_{\tilde{T}, s}) \notin G_p^{(g)}$ . We use the setting in Section 5 with a state  $s \in \mathcal{S}(\tilde{T})$  treated as a parameter as in the following lemma.

**Lemma 6.8** *There is a map  $B: \mathcal{S}(\tilde{T}) \rightarrow \Gamma_g'', s \mapsto B^s$ , satisfying the conditions: For all  $s \in \mathcal{S}(\tilde{T})$ , we have  $\bar{Y}^{\otimes g}(J_{\tilde{T},s}) \in \mathcal{F}'(B^s)(1)$ , and we have  $B^s = b_4 \circ b_3 \circ b_2 \circ b_1^s$  with  $(b_1^s, b_2, b_3, b_4) \in \tilde{\Gamma}_g''$  such that*

$$b_1^s = \langle D^{\pm 1} \rangle^{\otimes l_1} \otimes \langle \Theta_{s(c_1)} \rangle \otimes \cdots \otimes \langle \Theta_{s(c_{l_2})} \rangle \otimes \langle \bar{U}_q^0 \rangle^{\otimes l_3},$$

for  $l_1, l_3 \geq 0$ , and  $l_2 = l$  is the number of the crossings of  $\tilde{T}$ , where all parts of  $B^s$  except  $\langle \Theta_{s(c_1)} \rangle \otimes \cdots \otimes \langle \Theta_{s(c_{l_2})} \rangle$  do not depend on  $s \in \mathcal{S}(\tilde{T})$ .

**Proof** We can define  $B$  as in the lemma by constructing  $B^s$  as follows. First, we choose a state  $x \in \mathcal{S}(\tilde{T})$ , and construct  $B_0^x \in \Gamma_g$  so that  $\bar{Y}^{\otimes g}(J_{\tilde{T},x}) \in \mathcal{F}(B_0^x)(1)$  as in the proof of Lemma 5.1. For a state  $s \in \mathcal{S}(\tilde{T})$ , let  $B_0^s \in \Gamma_g$  obtained from  $B_0^x$  by replacing  $\langle \Theta_{x(c_p)} \rangle$  with  $\langle \Theta_{s(c_p)} \rangle$  for  $p = 1, \dots, l_2$ . By the construction of  $B_0^s$ , we have  $\bar{Y}^{\otimes g}(J_{\tilde{T},s}) \in \mathcal{F}(B_0^s)(1)$ . Second, by Lemma 5.4 and Lemma 5.7, we can transform  $B_0^x$  into some  $B^x \in \Gamma_g''$  by using the preorder  $\preceq$  and  $\preceq'$ . We have  $\bar{Y}^{\otimes g}(J_{\tilde{T},x}) \in \mathcal{F}'(B^x)(1)$  by Lemma 5.3 and Lemma 5.6. Since  $\preceq$  and  $\preceq'$  each does not depend on any  $\langle \Theta_{x(c_p)} \rangle$ , we can obtain the desired  $B^s \in \Gamma_g''$  from  $B^x$  by replacing  $\langle \Theta_{x(c_p)} \rangle$  with  $\langle \Theta_{s(c_p)} \rangle$  for  $p = 1, \dots, l_2$ . □

We fix  $B: \mathcal{S}(\tilde{T}) \rightarrow \Gamma_g'', s \mapsto B^s = b_4 \circ b_3 \circ b_2 \circ b_1^s$ , as in Lemma 6.8. For a state  $s \in \mathcal{S}(\tilde{T})$ , recall from Section 5.7 the expansion of  $B^s$ : First, we write  $b_2 \circ b_1^s = \sigma \circ \tilde{b}_1^s$  with  $\sigma \in \text{Hom}(\mathcal{A}_\Theta)$  and

$$\tilde{b}_1^s = \langle D^{\pm 1} \rangle^{\otimes l_1} \otimes \left( \bigotimes_{p=1}^{l_2} (\langle \Delta \rangle^{[m_p, n_p]} \circ \langle \Theta_{s(c_p)} \rangle) \right) \otimes \langle \bar{U}_q^0 \rangle^{\otimes l_3},$$

for  $m_1, \dots, m_{l_2}, n_1, \dots, n_{l_2} \geq 1$ , and then for  $\mathbf{i}_p \in \mathcal{I}(s(c_p), m_p), \bar{\mathbf{i}}_p \in \mathcal{I}(s(c_p), n_p), p = 1, \dots, l_2$ , we set

$$\tilde{b}_1^s(\mathbf{i}_1, \bar{\mathbf{i}}_1, \dots, \mathbf{i}_{l_2}, \bar{\mathbf{i}}_{l_2}) = \langle D^{\pm 1} \rangle^{\otimes l_1} \otimes \left( \bigotimes_{p=1}^{l_2} (\langle \{s(c_p)\}_q \rangle! \otimes \langle \tilde{F}^{\mathbf{i}_p} \rangle \otimes \langle \tilde{E}^{\bar{\mathbf{i}}_p} \rangle) \right) \otimes \langle \bar{U}_q^0 \rangle^{\otimes l_3}.$$

Recall that we have

$$(59) \quad \mathcal{F}'(B^s)(1) \subset \sum_{\substack{\mathbf{i}_p \in \mathcal{I}(s(c_p), m_p) \\ \bar{\mathbf{i}}_p \in \mathcal{I}(s(c_p), n_p) \\ p=1, \dots, l_2}} \mathcal{F}'(b_4 \circ b_3 \circ \sigma \circ \tilde{b}_1^s(\mathbf{i}_1, \bar{\mathbf{i}}_1, \dots, \mathbf{i}_{l_2}, \bar{\mathbf{i}}_{l_2}))(1).$$

Let

$$\begin{aligned} \mathbf{i}_p &= (i_{(p,0,1)}, \dots, i_{(p,0,m_p)}) \in \mathcal{I}(s(c_p), m_p), \\ \bar{\mathbf{i}}_p &= (i_{(p,1,1)}, \dots, i_{(p,1,n_p)}) \in \mathcal{I}(s(c_p), n_p), \end{aligned}$$



for  $p = 1, \dots, l_2$ . Set

$$N^s(\mathbf{i}_1, \bar{\mathbf{i}}_1, \dots, \mathbf{i}_l, \bar{\mathbf{i}}_l) = \max\{i_{(p,0,i)}, i_{(p,1,j)} \mid 1 \leq i \leq m_p, 1 \leq j \leq n_p, 1 \leq p \leq l_2\},$$

$$N^s = \min\{N^s(\mathbf{i}_1, \bar{\mathbf{i}}_1, \dots, \mathbf{i}_l, \bar{\mathbf{i}}_l) \mid \mathbf{i}_p \in \mathcal{I}(s(c_p), m_p), \bar{\mathbf{i}}_p \in \mathcal{I}(s(c_p), n_p), 1 \leq p \leq l_2\}.$$

**Lemma 6.7** follows from (59) and the following two lemmas.

**Lemma 6.9** For  $r \geq 0$ , there are only finitely many states  $s \in \mathcal{S}(\tilde{T})$  such that  $N^s \leq r$ .

**Lemma 6.10** For  $s \in \mathcal{S}(\tilde{T})$  and  $r \geq 0$  such that  $N^s \geq 2r$ , we have

$$\mathcal{F}'(b_4 \circ b_3 \circ \sigma \circ \tilde{b}_1^s(\mathbf{i}_1, \bar{\mathbf{i}}_1, \dots, \mathbf{i}_{l_2}, \bar{\mathbf{i}}_{l_2}))(1) \subset G_r^{(g)},$$

for all  $\mathbf{i}_p \in \mathcal{I}(s(c_p), m_p), \bar{\mathbf{i}}_p \in \mathcal{I}(s(c_p), n_p), p = 1, \dots, l_2$ .

**Proof of Lemma 6.9** Note that for  $\mathbf{i} = (i_1, \dots, i_l) \in \mathcal{I}(k, l), k \geq 0, l \geq 1$ , we have

$$\frac{k}{l} \leq \max(i_1, \dots, i_l).$$

Thus we have

$$w^s := \max\left\{\frac{s(c_p)}{m_p}, \frac{s(c_p)}{n_p} \mid 1 \leq p \leq l_2\right\} \leq N^s(\mathbf{i}_1, \bar{\mathbf{i}}_1, \dots, \mathbf{i}_l, \bar{\mathbf{i}}_l),$$

for all  $\mathbf{i}_p \in \mathcal{I}(s(c_p), m_p), \bar{\mathbf{i}}_p \in \mathcal{I}(s(c_p), n_p), p = 1, \dots, l_2$ . Hence we have

$$(60) \quad w^s \leq N^s.$$

It is not difficult to prove that, for  $r \geq 0$ , there are only finitely many states  $s \in \mathcal{S}(\tilde{T})$  such that  $w^s \leq r$ . This and (60) imply the assertion.  $\square$

**Proof of Lemma 6.10** The proof is similar to the last step of the proof of Lemma 5.2 in Section 5.8. By replacing  $s_p$  with  $s(c_p)$  for  $p = 1, \dots, l_2$ , we use the notation and results in Section 5.8.

Fix  $\mathbf{i}_p \in \mathcal{I}(s(c_p), m_p)$  and  $\bar{\mathbf{i}}_p \in \mathcal{I}(s(c_p), n_p)$ , for  $p = 1, \dots, l_2$ . Recall that we color the output edges of  $\tilde{b}_1^s(\mathbf{i}_1, \bar{\mathbf{i}}_1, \dots, \mathbf{i}_{l_2}, \bar{\mathbf{i}}_{l_2})$  with the labels in  $\mathcal{P}$  as in Figure 39. Note that

$$M := N^s(\mathbf{i}_1, \bar{\mathbf{i}}_1, \dots, \mathbf{i}_l, \bar{\mathbf{i}}_l) = \max\{i_a \mid a \in \mathcal{P}\} \geq N^s \geq 2r.$$

Since the filtration  $\{G_p\}_{p \geq 0}$  is decreasing, it is enough to prove

$$(61) \quad \mathcal{F}'(b_4 \circ b_3 \circ \sigma \circ \tilde{b}_1^s(\mathbf{i}_1, \bar{\mathbf{i}}_1, \dots, \mathbf{i}_{l_2}, \bar{\mathbf{i}}_{l_2}))(1) \subset G_{\lfloor M/2 \rfloor}^{(g)}.$$

We prove (61). Recall that  $\mathcal{P}_{\text{iso}} \subset \mathcal{P}$  denotes the set of isolated labels, and  $\mathcal{P}_A^2$  denotes the set of unordered pairs  $\{a, b\}$  of mutually adjacent labels  $a, b \in \mathcal{P}$ . Set

$$\mathcal{P}_Y = \mathcal{P} \setminus \mathcal{P}_{\text{iso}} = \bigcup \mathcal{P}_A^2.$$

Set  $M_{\text{iso}} = \max\{i_a \mid a \in \mathcal{P}_{\text{iso}}\}$  and  $M_Y = \max\{i_a \mid a \in \mathcal{P}_Y\}$ . It is enough to prove

- (i)  $\mathcal{F}'(b_4 \circ b_3 \circ \sigma \circ \tilde{b}_1^s(\mathbf{i}_1, \bar{\mathbf{i}}_1, \dots, \mathbf{i}_{l_2}, \bar{\mathbf{i}}_{l_2}))(1) \subset G_{M_{\text{iso}}}^{(g)} (\subset G_{\lfloor M_{\text{iso}}/2 \rfloor}^{(g)})$ ,
- (ii)  $\mathcal{F}'(b_4 \circ b_3 \circ \sigma \circ \tilde{b}_1^s(\mathbf{i}_1, \bar{\mathbf{i}}_1, \dots, \mathbf{i}_{l_2}, \bar{\mathbf{i}}_{l_2}))(1) \subset G_{\lfloor M_Y/2 \rfloor}^{(g)}$ .

Let us prove (i). Recall from (54) that

$$\mathcal{F}'(b_3 \circ \sigma \circ \tilde{b}_1^s(\mathbf{i}_1, \bar{\mathbf{i}}_1, \dots, \mathbf{i}_{l_2}, \bar{\mathbf{i}}_{l_2}))(1) \subset U_{\mathbb{Z},q}^{\otimes l_4} \otimes (\bar{U}_q^{\text{ev}})^{\otimes l_5+l_6}.$$

Thus, it is enough to prove

$$(62) \quad \mathcal{F}'(b_4)(U_{\mathbb{Z},q}^{\otimes l_4} \otimes (\bar{U}_q^{\text{ev}})^{\otimes l_5+l_6}) \subset G_{M_{\text{iso}}}^{(g)}.$$

Recall that the first  $l_4$  input edges of  $b_4$  are connected to the left (resp. right) input edges of the  $\langle \text{ad} \rangle$ 's (resp.  $\langle \overline{\text{ad}} \rangle$ 's), and the next  $l_5 + l_6$  input edges of  $b_4$  go down to the edges of the  $\langle \mu \rangle$ 's and to the right (resp. left) input edges of the  $\langle \text{ad} \rangle$ 's (resp.  $\langle \overline{\text{ad}} \rangle$ 's). By the definition of  $C_p$  and  $C'_p$ , we have

$$(63) \quad \text{ad}(U_{\mathbb{Z},q} \tilde{E}^{(p)} \otimes \bar{U}_q^{\text{ev}}) \subset C_p \subset G_p,$$

$$(64) \quad \text{ad}(U_{\mathbb{Z},q} \tilde{F}^{(p)} \otimes \bar{U}_q^{\text{ev}}) \subset C'_p \subset G_p,$$

for  $p \geq 0$ . We also have

$$(65) \quad \begin{aligned} \overline{\text{ad}}(\bar{U}_q^{\text{ev}} \otimes U_{\mathbb{Z},q} \tilde{E}^{(p)}) &\subset \overline{\text{ad}}(\bar{U}_q^{\text{ev}} \otimes \tilde{E}^{(p)}) \\ &\subset \text{ad}(S^{-1}(\tilde{E}^{(p)}) \otimes \bar{U}_q^{\text{ev}}) \\ &\subset \text{ad}(\bar{U}_q^0 \tilde{E}^{(p)} \otimes \bar{U}_q^{\text{ev}}) \subset C_p \subset G_p, \end{aligned}$$

for  $p \geq 0$ . Similarly, we have

$$(66) \quad \overline{\text{ad}}(\bar{U}_q^{\text{ev}} \otimes U_{\mathbb{Z},q} \tilde{F}^{(p)}) \subset C'_p \subset G_p,$$

for  $p \geq 0$ . Thus, (62) follows from (63)–(66) and the inclusions

$$(67) \quad \mu(U_{\mathbb{Z},q} \otimes G_p) = \mu(G_p \otimes U_{\mathbb{Z},q}) \subset G_p,$$

$$(68) \quad \text{ad}(U_{\mathbb{Z},q} \otimes G_p) \subset G_p, \quad \overline{\text{ad}}(G_p \otimes U_{\mathbb{Z},q}) \subset G_p.$$

for  $p \geq 0$ . We have finished the proof of (i).

Let us prove (ii). Recall from (48) that

$$(69) \quad \mathcal{F}'(b_3 \circ \sigma \circ \tilde{b}_1^s(\mathbf{i}_1, \bar{\mathbf{1}}_1, \dots, \mathbf{i}_{l_2}, \bar{\mathbf{1}}_{l_2}))(1) \\ \subset \left( \prod_{p=1}^{l_2} \{s(c_p)\}_q!\right) \cdot (U_{\mathbb{Z},q}^{\otimes l_4} \otimes \mathcal{F}'(Z)(1) \otimes (\bar{U}_q^{\text{ev } 0})^{\otimes l_6}),$$

where  $Z \in \langle \dot{Y} \rangle^{\otimes l_5} \circ \text{Hom}_{\mathcal{A}}(I, A^{\otimes 2l_5})$ . We study  $\mathcal{F}'(Z)(1)$  by using the following inclusions (70)–(74) instead of (49)–(53).

For  $X_1, X_2 \in \{E, F\}$  and  $i_a, i_b \geq 0$  for  $\{a, b\} \in \mathcal{P}_A^2$ , we have

$$(70) \quad \dot{Y}(\bar{U}_q^0 \tilde{X}_1^{(i_a)} \otimes \bar{U}_q^0 \tilde{X}_2^{(i_b)}) \subset (\{\min(i_a, i_b)\}_q!)^{-1} \cdot \mathcal{Y}_{\max(i_a, i_b)}.$$

We also have

$$(71) \quad \sum \dot{Y}(\bar{U}_q^0 \tilde{X}_1^{(i_a)} \otimes \bar{U}_q^0 D'_\pm) \otimes \dot{Y}(\bar{U}_q^0 \tilde{X}_2^{(i_b)} \otimes \bar{U}_q^0 D''_\pm) \\ \subset (\{\min(i_a, i_b)\}_q!)^{-1} \cdot (\mathcal{Y}^D)_{\max(i_a, i_b)},$$

$$(72) \quad \sum \dot{Y}(\bar{U}_q^0 \tilde{X}_1^{(i_a)} \otimes \bar{U}_q^0 D'_\pm) \otimes \dot{Y}(\bar{U}_q^0 D''_\pm \otimes \bar{U}_q^0 \tilde{X}_2^{(i_b)}) \\ \subset (\{\min(i_a, i_b)\}_q!)^{-1} \cdot (\mathcal{Y}^D)_{\max(i_a, i_b)},$$

$$(73) \quad \sum \dot{Y}(\bar{U}_q^0 D'_\pm \otimes \bar{U}_q^0 \tilde{X}_1^{(i_a)}) \otimes \dot{Y}(\bar{U}_q^0 \tilde{X}_2^{(i_b)} \otimes \bar{U}_q^0 D''_\pm) \\ \subset (\{\min(i_a, i_b)\}_q!)^{-1} \cdot (\mathcal{Y}^D)_{\max(i_a, i_b)},$$

$$(74) \quad \sum \dot{Y}(\bar{U}_q^0 D'_\pm \otimes \bar{U}_q^0 \tilde{X}_1^{(i_a)}) \otimes \dot{Y}(\bar{U}_q^0 D''_\pm \otimes \bar{U}_q^0 \tilde{X}_2^{(i_b)}) \\ \subset (\{\min(i_a, i_b)\}_q!)^{-1} \cdot (\mathcal{Y}^D)_{\max(i_a, i_b)}.$$

By the above inclusions (70)–(74), and by Lemmas 6.5 and 6.6, we have

$$(75) \quad \mathcal{F}'(Z)(1) \subset \prod_{\{a,b\} \in \mathcal{P}_A^2} (\{\min(i_a, i_b)\}_q!)^{-1} \cdot G_{[M_Y/2]}^{(l_5)}.$$

Thus, by (69), (75) and (56), we have

$$\mathcal{F}'(b_3 \circ \sigma \circ \tilde{b}_1^s(\mathbf{i}_1, \bar{\mathbf{1}}_1, \dots, \mathbf{i}_{l_2}, \bar{\mathbf{1}}_{l_2}))(1) \subset U_{\mathbb{Z},q}^{\otimes l_4} \otimes G_{[M_Y/2]}^{(l_5)} \otimes (\bar{U}_q^{\text{ev } 0})^{\otimes l_6} \\ \subset U_{\mathbb{Z},q}^{\otimes l_4} \otimes G_{[M_Y/2]}^{(l_5+l_6)}.$$

For the rest of the proof, it is enough to prove the inclusion

$$(76) \quad \mathcal{F}'(b_4)(U_{\mathbb{Z},q}^{\otimes l_4} \otimes G_{[M_Y/2]}^{(l_5+l_6)}) \subset G_{[M_Y/2]}^{(g)},$$

which follows from (67) and (68). This completes the proof. □

**Acknowledgments** The author is deeply grateful to Professor Kazuo Habiro and Professor Tomotada Ohtsuki for helpful advice and encouragement. She would also like to thank the anonymous referee for valuable suggestions. This work was partially supported by JSPS Research Fellowships for Young Scientists.

## References

- [1] **C De Concini, C Procesi**, *Quantum groups*, from: “ $D$ -modules, representation theory, and quantum groups (Venice, 1992)”, (G Zampieri, A D’Agnolo, editors), Lecture Notes in Math. 1565, Springer, Berlin (1993) 31–140 [MR1288995](#)
- [2] **M Eisermann**, *The Jones polynomial of ribbon links*, *Geom. Topol.* 13 (2009) 623–660 [MR2469525](#)
- [3] **N Habegger, X-S Lin**, *The classification of links up to link-homotopy*, *J. Amer. Math. Soc.* 3 (1990) 389–419 [MR1026062](#)
- [4] **K Habiro**, *Spanning surfaces and the Jones polynomial*, in preparation
- [5] **K Habiro**, *Bottom tangles and universal invariants*, *Algebr. Geom. Topol.* 6 (2006) 1113–1214 [MR2253443](#)
- [6] **K Habiro**, *An integral form of the quantized enveloping algebra of  $\mathfrak{sl}_2$  and its completions*, *J. Pure Appl. Algebra* 211 (2007) 265–292 [MR2333771](#)
- [7] **K Habiro**, *A unified Witten–Reshetikhin–Turaev invariant for integral homology spheres*, *Invent. Math.* 171 (2008) 1–81 [MR2358055](#)
- [8] **M Hennings**, *Invariants of links and 3-manifolds obtained from Hopf algebras*, *J. London Math. Soc.* 54 (1996) 594–624 [MR1413901](#)
- [9] **V F R Jones**, *A polynomial invariant for knots via von Neumann algebras*, *Bull. Amer. Math. Soc.* 12 (1985) 103–111 [MR766964](#)
- [10] **C Kassel**, *Quantum groups*, *Graduate Texts in Math.* 155, Springer, New York (1995) [MR1321145](#)
- [11] **L H Kauffman**, *Gauss codes, quantum groups and ribbon Hopf algebras*, *Rev. Math. Phys.* 5 (1993) 735–773 [MR1253734](#)
- [12] **L Kauffman, D E Radford**, *Oriented quantum algebras, categories and invariants of knots and links*, *J. Knot Theory Ramifications* 10 (2001) 1047–1084 [MR1867109](#)
- [13] **R J Lawrence**, *A universal link invariant using quantum groups*, from: “Differential geometric methods in theoretical physics (Chester, 1988)”, (A I Solomon, editor), *World Sci. Publ.*, Teaneck, NJ (1989) 55–63 [MR1124415](#)
- [14] **R J Lawrence**, *A universal link invariant*, from: “The interface of mathematics and particle physics (Oxford, 1988)”, (D G Quillen, G B Segal, S T Tsou, editors), *Inst. Math. Appl. Conf. Ser. New Ser.* 24, Oxford Univ. Press, New York (1990) 151–156 [MR1103138](#)

- [15] **G Lusztig**, *Introduction to quantum groups*, Progress in Math. 110, Birkhäuser, Boston (1993) [MR1227098](#)
- [16] **S Mac Lane**, *Categories for the working mathematician*, second edition, Graduate Texts in Math. 5, Springer, New York (1998) [MR1712872](#)
- [17] **J Milnor**, *Link groups*, Ann. of Math. 59 (1954) 177–195 [MR0071020](#)
- [18] **J Milnor**, *Isotopy of links*, from: “Algebraic geometry and topology: A symposium in honor of S Lefschetz”, (R H Fox, D C Spencer, A W Tucker, editors), Princeton Univ. Press (1957) 280–306 [MR0092150](#)
- [19] **T Ohtsuki**, *Colored ribbon Hopf algebras and universal invariants of framed links*, J. Knot Theory Ramifications 2 (1993) 211–232 [MR1227011](#)
- [20] **N Y Reshetikhin, V G Turaev**, *Ribbon graphs and their invariants derived from quantum groups*, Comm. Math. Phys. 127 (1990) 1–26 [MR1036112](#)
- [21] **S Suzuki**, *Bing doubling and the colored Jones polynomial*, in preparation
- [22] **S Suzuki**, *On the colored Jones polynomials of ribbon links, boundary links and Brunnian links* [arXiv:1111.6408](#)
- [23] **S Suzuki**, *On the universal  $sl_2$  invariant of ribbon bottom tangles*, Algebr. Geom. Topol. 10 (2010) 1027–1061 [MR2629775](#)

Research Institute for Mathematical Sciences, Kyoto University  
Kyoto 606-8502, Japan

[sakie@kurims.kyoto-u.ac.jp](mailto:sakie@kurims.kyoto-u.ac.jp)

<http://www.kurims.kyoto-u.ac.jp/~sakie/>

Received: 2 April 2011      Revised: 1 February 2012