

## SYMMETRIC UNIONS AND RIBBON KNOTS

CHRISTOPH LAMM

(Received November 6, 1998)

### 1. Introduction

In their article “On unions of knots” [15] S. Kinoshita and H. Terasaka studied a way of connecting knot diagrams which generalizes the operation of connected sum: an additional two-string tangle with  $n$  half-twists is inserted between the two diagrams. For the case that the two knot diagrams are mirror images of each other they found that the Alexander polynomial depends only on the parity of  $n$  and that the determinant is independent of  $n$ .

The results of [15] generalize in a natural way to the case where several twist tangles are inserted. We call such a generalized union of a knot  $\hat{K}$  with its mirror image  $\hat{K}^*$  *symmetric union*, and  $\hat{K}$  is called the *partial knot*.

In addition to results on the Alexander polynomial and the determinant, we use the homology of the double branched coverings and the knot groups to exclude possible partial knots for a given symmetric union. We prove that a symmetric union with non-trivial partial knot is itself non-trivial. (This is an analogue of the non-cancellation theorem for the connected sum of knots.)

Finally, we investigate the relationship between symmetric unions and ribbon knots. We succeed in finding symmetric diagrams for all but one of the 21 prime ribbon knots up to 10 crossings.

### 2. Symmetric unions

We denote the tangles made of half-twists by integers  $n \in \mathbb{Z}$  and the horizontal trivial tangle by  $\asymp$  (Fig. 1).

**DEFINITION 2.1.** Let  $D$  be an unoriented knot diagram and  $D^*$  the diagram  $D$  reflected at an axis in the plane. If in the symmetric placement of  $D$  and  $D^*$  we replace the tangles  $T_i = 0$ , ( $i = 0, \dots, k$ ) on the symmetry axis by  $T_i = \asymp$  for  $i = 0, \dots, \mu - 1$  and  $T_i = n_i \in \mathbb{Z}$  for  $i = \mu, \dots, k$  (with  $\mu \geq 1$ ), we call the result a *symmetric union* of  $D$  and  $D^*$  and write  $D \cup D^*(T_0, \dots, T_k)$ . The *partial knot*  $\hat{K}$  of the symmetric union is the knot given by the diagram  $D$ . See Fig. 1 for an illustration of the case  $\mu = 1$ .

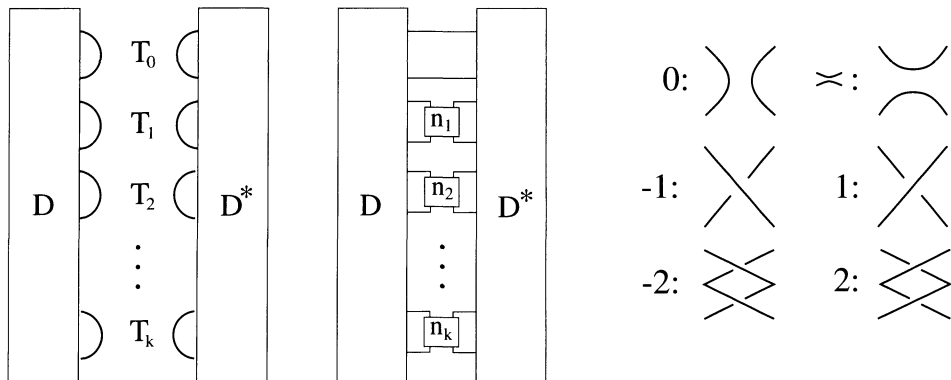

Fig. 1.

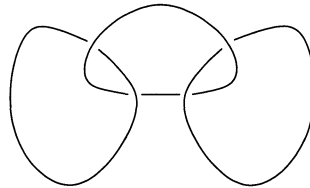

Fig. 2.

REMARK 2.2. a) As seen from the symmetry,  $\mu$  is the number of components of the symmetric union. See Fig. 2 for a diagram where  $\mu$  is not equal to the number of components and which is not a symmetric union.

b) Kinoshita and Terasaka [15] call a union with  $\mu = 1, k = 1$  *symmetric* if  $n_1$  is even and *skew-symmetric* if  $n_1$  is odd. If  $k \geq 2$  they do not go into details and call it *generalized union*. Unions of knots were also studied in the articles [6], [7], [9]–[11], [14], [19] and [20].

c) If we assign an orientation to an arc on the left side of the symmetric union, then the orientation of the corresponding arc on the right side is the opposite of the mirrored orientation. The mirrored orientation would cause a clash of orientations on the symmetry plane. Hence the crossings on the symmetry plane are always oriented from left to right or vice versa, see Fig. 3.

d) The insertion of an odd tangle has the effect that the orientation of a part of the diagram is reversed. If all  $n_i$  are even then the orientation of  $D$  passes over to the symmetric union.

**Theorem 2.3.** *The Alexander polynomial of a symmetric union with  $\mu \geq 2$  is zero.*

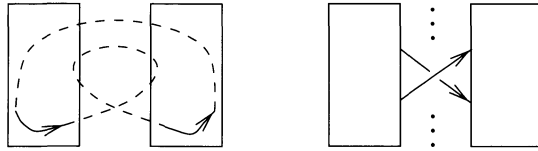

Fig. 3.

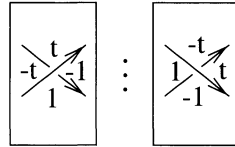

Fig. 4.

Proof. We can assume that  $\mu = 2$  because the cases  $\mu > 2$  can be deduced from this by induction, using the skein relation for the Alexander polynomial and part c) of Remark 2.2. We write down the Alexander matrix for the diagram and delete the columns for the outer region and the region between the two strings of the tangle  $T_0 = \infty$ . See Fig. 4 for the contributions of each crossing and [1] for more details of the definition. If the diagram is connected there are an equal number of regions and crossings left. (If it is not connected, then one component is isolated and the Alexander polynomial of such a split link is zero.) The determinant of the Alexander matrix is the Alexander polynomial of the link. We form the following groups of regions: there are the regions in the left and right half of the diagram, the regions in the middle (inside the half-twists) and the regions which extend to both sides. In the same way there are the crossings in the middle, the left and the right of the diagram. The reader should check that the Alexander matrix is of the form:

$$\begin{pmatrix} * & * & * & * \\ 0 & N & M & 0 \\ 0 & -N & 0 & -M \end{pmatrix}.$$

The stars in the first block of rows mean that we do not need the information contained in these entries for our argument. Let  $a_D$  be the number of left regions. Then the dimensions of the columns are  $\sum_{i=2}^k (|n_i| - 1)$ ,  $k + 1$ ,  $a_D$ ,  $a_D$  (for middle, both, left and right regions, respectively) and the dimensions of the rows are  $\sum_{i=2}^k |n_i|$ ,  $a_D + 1$ ,  $a_D + 1$  (for middle, left and right crossings). Adding the second block of rows to the third annihilates the  $N$ , then adding the fourth block of columns to the third gives zero in the whole third block of rows but the  $-M$  in the end. The determinant is zero be-

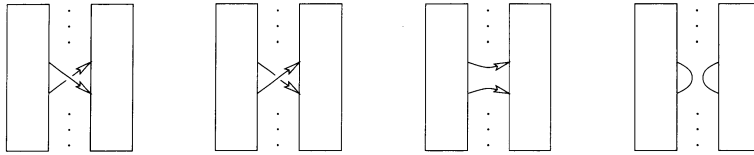

Fig. 5.

cause the last  $a_D + 1$  rows have non-zero entries only in the last  $a_D$  columns, hence they are linearly dependent.  $\square$

**Theorem 2.4.** *Let  $\mu = 1$ . Then the Alexander polynomial of a symmetric union depends only on the parities of the numbers  $n_i$ : if  $n_i \equiv n'_i \pmod{2}$  for all  $i \in \{1, \dots, k\}$  then*

$$\Delta(D \cup D^*(\asymp, n_1, \dots, n_k)) = \Delta(D \cup D^*(\asymp, n'_1, \dots, n'_k)).$$

*Proof.* Smoothing a crossing on the symmetry plane gives a symmetric union with  $\mu = 2$  which by Theorem 2.3 has vanishing Alexander polynomial. Hence, by the skein relation, a crossing change on the symmetry plane does not change the Alexander polynomial. The theorem expresses this in terms of the numbers  $n_i$ .  $\square$

**REMARK 2.5.** Since the Alexander polynomial of an amphicheiral 2-component link is zero ([13], Theorem 8.4.1), the proof of Theorem 2.4 is especially easy if  $k = 1$  (this is the situation of Kinoshita and Terasaka [15]). In this case we do not need the Alexander matrix for proving Theorem 2.3.

**Theorem 2.6.** *If  $\mu = 1$  the determinant of a symmetric union is independent of the numbers  $n_i$ , and therefore it is the square of the determinant of the partial knot:*

$$\det(D \cup D^*(\asymp, n_1, \dots, n_k)) = \det(D)^2.$$

*Proof.* We look at one particular crossing inside a tangle  $T_i$  on the symmetry plane. For a skein quadruple  $(L_+, L_-, L_0, L_\infty)$  (see Fig. 5) we have the formula

$$(\det L_+)^2 + (\det L_-)^2 = 2[(\det L_0)^2 + (\det L_\infty)^2],$$

well-known from properties of the Kauffman polynomial (see for instance [17], p. 101). From the Theorems 2.3 and 2.4 we know  $\det L_+ = \det L_-$  and  $\det L_0 = 0$ , because  $\det L = |\Delta_L(-1)|$ . Hence the conclusion is  $\det L_\infty = \det L_+ = \det L_-$ . If we use this for all crossings on the symmetry plane the proposition follows.  $\square$

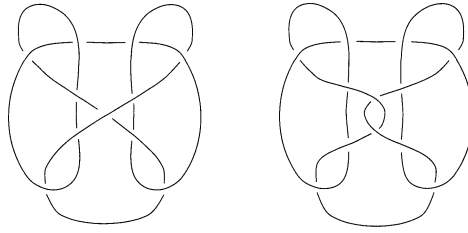

Fig. 6.

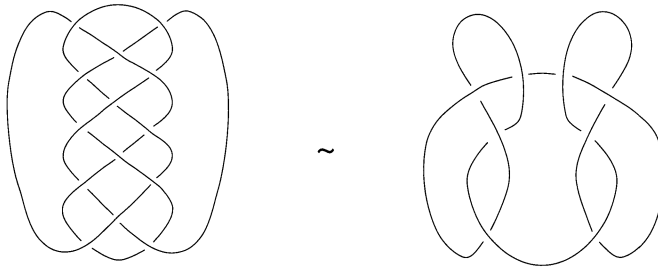

Fig. 7.

EXAMPLE 2.7. The knot  $10_{153}$  and the Kinoshita-Terasaka knot are symmetric unions of the trivial knot (Fig. 6). Hence they have determinant 1. The Kinoshita-Terasaka knot has  $n_1 = 2$  and therefore its Alexander polynomial is equal to 1.

REMARK 2.8. If  $K_1$  and  $K_2$  are symmetric unions, so are  $K_1^*$  and  $-K_1$  and the connected sum  $K_1 \sharp K_2$ .

### 3. Symmetric unions and their partial knots

**3.1. Non-uniqueness of the partial knots** Obviously, if  $\hat{K}$  is a partial knot of the symmetric union  $K$  then  $\hat{K}^*$  is also a partial knot of  $K$ . In Fig. 7 we give an example of different partial knots for a symmetric union, which are not mirror images of each other. The left symmetric union has partial knot  $5_1$  and the right knot is  $4_1 \sharp 4_1^*$  with partial knot  $4_1$ . Of course, by Theorem 2.6, the determinants of the two partial knots are equal.

**3.2. Homology of the double branched coverings** We give a second proof for Theorem 2.6, using the Goeritz matrix of a diagram of  $K$ . If  $G_K$  is a Goeritz matrix of  $K$ , then  $|\det(G_K)| = \det(K)$ , see [17], p. 99. If the knot diagram  $D$  has  $r + 1$  black regions in the chessboard colouring, then the pre-Goeritz matrix of  $D$  is an  $(r + 1) \times (r + 1)$  matrix with entries  $g_{i,j} = \sum \zeta(c)$ , (for  $i \neq j$ , the sum is over all crossings  $c$ ,

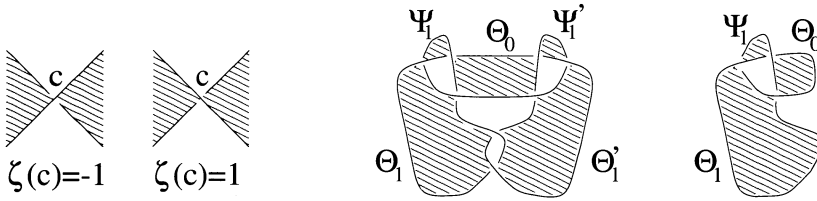

Fig. 8.

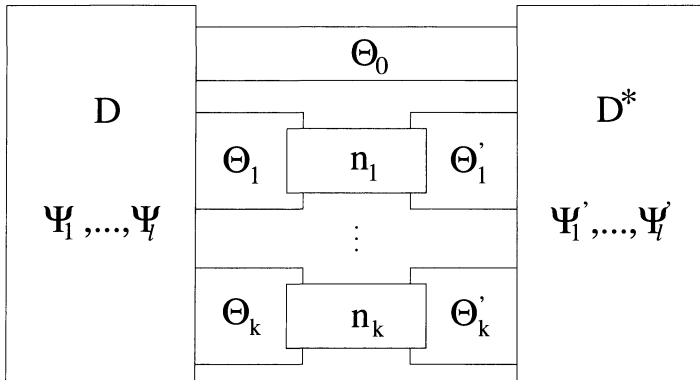

Fig. 9.

where the regions  $i$  and  $j$  come together) and  $g_{i,i} = -\sum_{j \neq i} g_{i,j}$ . Deleting one row and the corresponding column we get a Goeritz matrix of  $D$ . The convention for  $\zeta(c)$  and an example are shown in Fig. 8.

Second proof of Theorem 2.6. We consider the diagram in Fig. 9. After deleting the column and row corresponding to  $\Theta_0$ , the Goeritz matrix belonging to the indicated colouring (with regions  $\Theta_1, \dots, \Theta_k, \Psi_1, \dots, \Psi_l, \Theta'_1, \dots, \Theta'_k, \Psi'_1, \dots, \Psi'_l$  in this order) has the following form

$$\begin{pmatrix} G_D + A & -A \\ -A & -G_D + A \end{pmatrix}.$$

The matrix  $A$  is a diagonal  $(k+l) \times (k+l)$ -matrix with diagonal entries  $n_1, \dots, n_k$  and  $l$  zeroes.  $G_D$  is the Goeritz matrix of the diagram  $D$ . We add the first block of rows to the second and get

$$\begin{pmatrix} G_D + A & -A \\ G_D & -G_D \end{pmatrix}.$$

Then we add the second block of columns to the first and the result is

$$\begin{pmatrix} G_D & -A \\ 0 & -G_D \end{pmatrix}.$$

Since the determinant of this matrix equals  $(-1)^{(k+l)} \det(G_D)^2$  we proved Theorem 2.6 again. □

We can extract even more information out of this simple form of the Goeritz matrix. If  $K$  is a knot we denote by  $M_2(K)$  the double cover of  $S^3$  branched over  $K$ . The Goeritz matrix of a knot  $K$  is a presentation matrix for the abelian group  $H_1(M_2(K))$ .

**Theorem 3.1.** *If the knot  $K$  is a symmetric union with partial knot  $\hat{K}$ , then  $H_1(M_2(\hat{K}))$  is a subgroup of  $H_1(M_2(K))$ .*

*Proof.* As shown in the second proof of Theorem 2.6 the Goeritz matrix  $G_K$  of the diagram  $D \cup D^*(\asymp, n_1, \dots, n_k)$  can be transformed by row and column operations to the form  $G'_K = \begin{pmatrix} G_{\hat{K}} & * \\ 0 & -G_{\hat{K}} \end{pmatrix}$ , where  $G_{\hat{K}}$  is the Goeritz matrix of  $D$ .

We consider  $G'_K$  and  $G_{\hat{K}}$  as matrices representing linear mappings in such a way that the images of the standard generators are the columns of the respective matrix. Assume that  $G_{\hat{K}}$  consists of  $m$  rows and columns. Then we have  $H_1(M_2(\hat{K})) \cong \mathbb{Z}^m / \text{Im}G_{\hat{K}}$ ,  $H_1(M_2(K)) \cong \mathbb{Z}^{2m} / \text{Im}G'_K$ . We define  $f : \mathbb{Z}^m / \text{Im}G_{\hat{K}} \rightarrow \mathbb{Z}^{2m} / \text{Im}G'_K$  by mapping the standard generators  $e_i \mapsto e_i$  for  $i = 1, \dots, m$ . This is well-defined because  $f(\text{Im}G_{\hat{K}}) \subset \text{Im}G'_K$ . Since  $|\det(-G_{\hat{K}})| = |\det(\hat{K})| \neq 0$ , from  $f(x) \in \text{Im}G'_K$  we conclude  $x \in \text{Im}G_{\hat{K}}$ , hence  $f$  is injective. □

**EXAMPLE 3.2.** We do not know if the knot  $10_{87}$  is a symmetric union. To exclude possible partial knots we use the Theorems 2.6 and 3.1. Since the determinant of  $10_{87}$  is 81, a partial knot  $\hat{K}$  must have determinant 9 and  $H_1(M_2(\hat{K}))$  must be a subgroup of  $H_1(M_2(10_{87})) = \mathbb{Z}/81$ . The knots with determinant 9 (up to nine crossings) are  $3_1 \# 3_1, 3_1 \# 3_1^*, 6_1, 8_{20}, 9_1$  and  $9_{46}$ . Since

$$\begin{aligned} H_1(M_2(\hat{K})) &= \mathbb{Z}/3 \oplus \mathbb{Z}/3 & \text{for } \hat{K} &= 3_1 \# 3_1, 3_1 \# 3_1^*, 9_{46} \text{ and} \\ H_1(M_2(\hat{K})) &= \mathbb{Z}/9 & \text{for } \hat{K} &= 6_1, 8_{20} \text{ and } 9_1, \end{aligned}$$

out of these 6 knots only  $6_1, 8_{20}$  and  $9_1$  could be partial knots of  $10_{87}$ .

**3.3. Knot groups** If  $K$  is a symmetric union with partial knot  $\hat{K}$ , we consider the knot group  $\pi(K)$  with meridian-longitude pair  $(m, l)$  and the knot group  $\pi(\hat{K})$  with meridian  $\hat{m}$ . Let  $\bar{\pi}(K) := \pi(K)/(m^2)$  be the knot group with the additional relations that all meridians have order two. We denote by  $[m]$  and  $[l]$  the images of the meridian and the longitude.

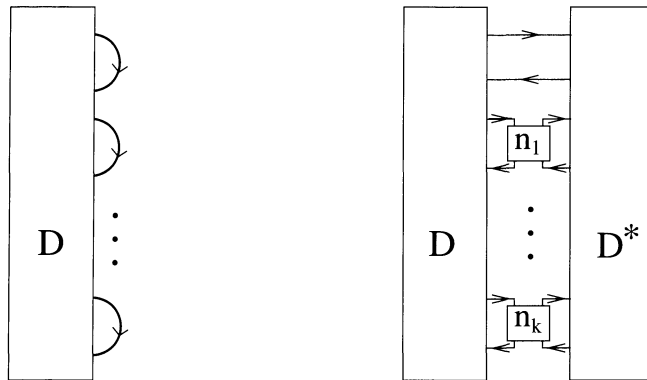

Fig. 10.

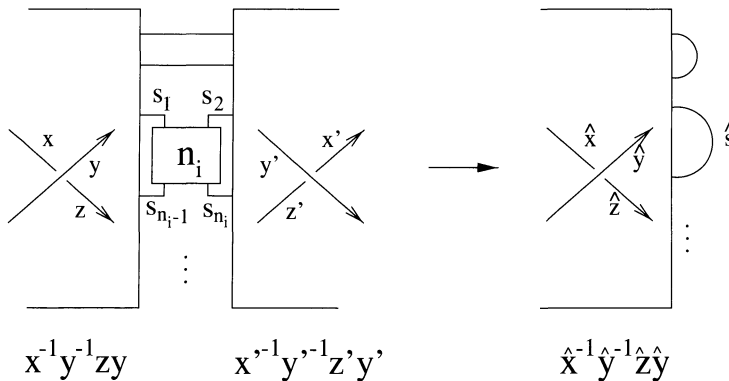

Fig. 11.

**Theorem 3.3** (M. Eisermann). *Suppose that  $K$  is a symmetric union with partial knot  $\hat{K}$ . If all  $n_i$  are even, there is a surjection  $(\pi(K), m, l) \rightarrow (\pi(\hat{K}), \hat{m}, 1)$ , and in the general case there is a surjection  $(\bar{\pi}(K), [m], [l]) \rightarrow (\bar{\pi}(\hat{K}), [\hat{m}], 1)$ .*

*Proof.* First, we assume that all  $n_i$  are even. In this case an orientation of  $D$  is compatible with the induced orientation of  $D \cup D^*(\infty, n_1, \dots, n_k)$  (Fig. 10). Hence, if we map the generators of the Wirtinger presentation of  $\pi(K)$  to the corresponding generators of  $\pi(\hat{K})$ , the relations are satisfied (see Fig. 11). Therefore the map is well-defined and surjective. For the longitude we use a curve in the diagram which is parallel to the knot. We insert before or after each undercrossing a full twist of opposite sign so that the linking number between  $l$  and  $K$  is zero. This longitude  $l$  is mapped to 1 in  $\pi(\hat{K})$  because the contributions of the symmetric undercrossings cancel. In the example illustrated in Fig. 12 the longitude is mapped to  $\dots y^{-1}xy \cdot y^{-1}y \cdot$



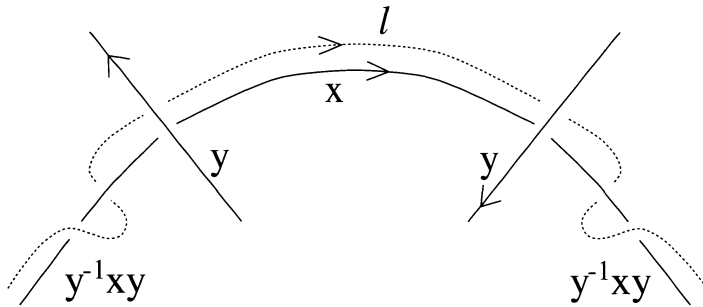

Fig. 12.

$y^{-1}x^{-1}y \dots = 1$ . This proves the first part of the theorem. In the general case the orientation of  $D$  can differ locally from the orientation of  $D \cup D^*(\asymp, n_1, \dots, n_k)$ . If we set  $m^2 = \hat{m}^2 = 1$  for the meridians, then the relations at the crossings are independent of the orientations of the arcs. The mapping is defined in the same way as in the first case, it is well-defined and surjective and the theorem is proved.  $\square$

REMARK 3.4. As the proof shows, the theorem remains valid when the twist tangles are replaced by arbitrary tangles.

**Theorem 3.5.** *If the partial knot of a symmetric union  $K$  is non-trivial, then  $K$  is non-trivial.*

Proof. In the article [3] the group  $\bar{\pi}(K)$  is called the  $\pi$ -orbifold group of  $K$ . It fits in the exact sequence

$$1 \rightarrow \pi_1(M_2(K)) \rightarrow \bar{\pi}(K) \rightarrow \mathbb{Z}_2 \rightarrow 1.$$

By the proof of the Smith conjecture [18] we have  $\bar{\pi}(K) \cong \mathbb{Z}_2$  if and only if  $K$  is the trivial knot (cf. [3], proof of Proposition 3.2). Hence Theorem 3.3 implies Theorem 3.5.  $\square$

**Homomorphisms on finite groups** Let  $G$  be a finite group and  $g \in G$  be an element of order two. We count the colourings of a knot with elements of  $G$ . More precisely let

$$c(K) = \sharp \text{Hom}((\bar{\pi}(K), [m]), (G, g)) \text{ and}$$

$$c_1(K) = \sharp \text{Hom}((\bar{\pi}(K), [m], [l]), (G, g, 1)).$$

Then, by Theorem 3.3, each colouring of  $\hat{K}$  yields a colouring of  $K$  with trivial longitude:

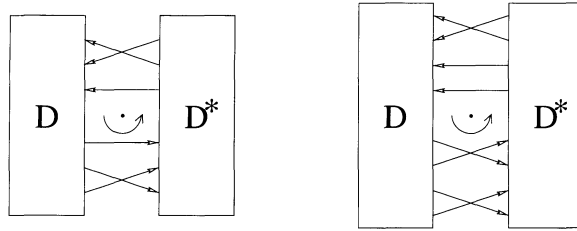

Fig. 13.

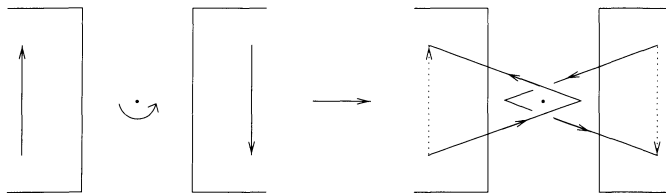

Fig. 14.

**Corollary 3.6.** *If  $K$  is a symmetric union with partial knot  $\hat{K}$ , then  $c_1(K) \geq c(\hat{K})$ .*

EXAMPLE 3.7. Let  $G$  be the symmetric group on eight letters and let  $g$  be the involution  $(12)(34)(56)$ . Then  $c(10_{87}) = c(8_{20}) = 201$  and  $c_1(10_{87}) = c_1(8_{20}) = 105$ . If  $10_{87}$  is a symmetric union, the knot  $8_{20}$  cannot be a partial knot of it (compare with Example 3.2).

#### 4. Braided symmetric unions

DEFINITION 4.1. A symmetric union which is a closed braid with respect to an axis in between  $D$  and  $D^*$  is called a *braided symmetric union*. See Fig. 13 for the case  $\mu = 1$ .

REMARK 4.2. Our interest in symmetric unions stems from cylinder factor knots (see [16])—which are closed braids. In addition, the characterization of symmetric unions (Homfly polynomial etc.) could profit from the next theorem.

**Theorem 4.3.** *Every symmetric union is also a braided symmetric union.*

Proof. As in the standard proof of Alexander’s theorem ([2], p.42) we take polygonal knots and eliminate negative edges. First we push the crossings at the symmetry plane over the braid axis to a place where both edges are positive. Then we

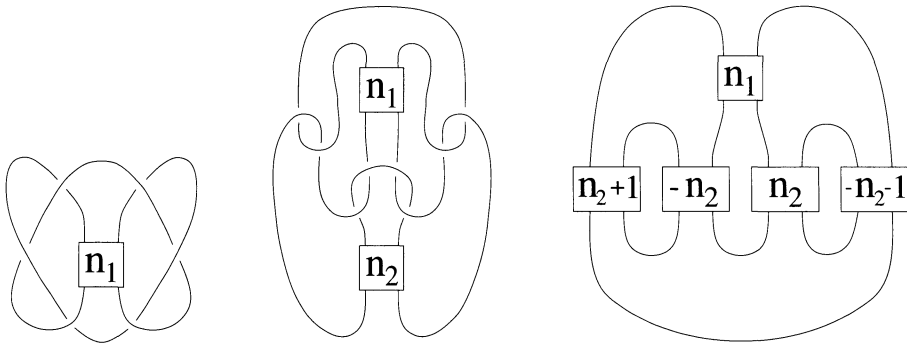

Fig. 15.

treat the negative edges away from the symmetry plane. If an edge is negative in  $D$  then its mirror image in  $D^*$  is also negative, because the orientation is mirrored and inverted. The procedure of inserting saw-teeth can be done symmetrically and at each step the diagram is still a symmetric union (Fig. 14). The result is a braided symmetric union.  $\square$

REMARK 4.4. Let  $\mu = 1$ . We write the parts  $D$  and  $D^*$  of the diagram of a braided symmetric union as  $\alpha \in \mathbf{B}_s$  and  $\alpha^{-1} \in \mathbf{B}_s$ , where  $\mathbf{B}_s$  is the  $s$ -string braid group. Let  $\beta_s$  be a braid word of the form  $\sigma_1^{\pm 1} \sigma_3^{\pm 1} \dots \sigma_{s-1}^{\pm 1}$  for even  $s$  and  $\sigma_1^{\pm 1} \sigma_3^{\pm 1} \dots \sigma_{s-2}^{\pm 1}$  for odd  $s$ . Then a braided symmetric union has the braid word  $\beta_{s-2} \alpha \beta_s \alpha^{-1}$  for even  $s$  and  $\beta_s \alpha \beta'_s \alpha^{-1}$  for odd  $s$ . Theorem 2.4 can be applied: the Alexander polynomial is independent of the crossing signs on the symmetry plane, e. g. the exponents of the  $\sigma_i$  above.

### 5. Symmetrization of ribbon knots

In this section we discuss the relationship between symmetric unions and ribbon knots and links. For the definition of ribbon links see [8].

**Theorem 5.1.** *All symmetric unions are ribbon links.*

We do not give a detailed proof of this, but just remark that the idea is the same as for connected sums  $K \sharp (-K^*)$ , only with additional half-twists of the ribbons on the symmetry plane.

REMARK 5.2. Theorem 2.3 can be deduced from the general result that  $\Delta(t) = 0$  for all ribbon links with 2 or more components (see [12] and [4]). We included our proof because it is especially easy.

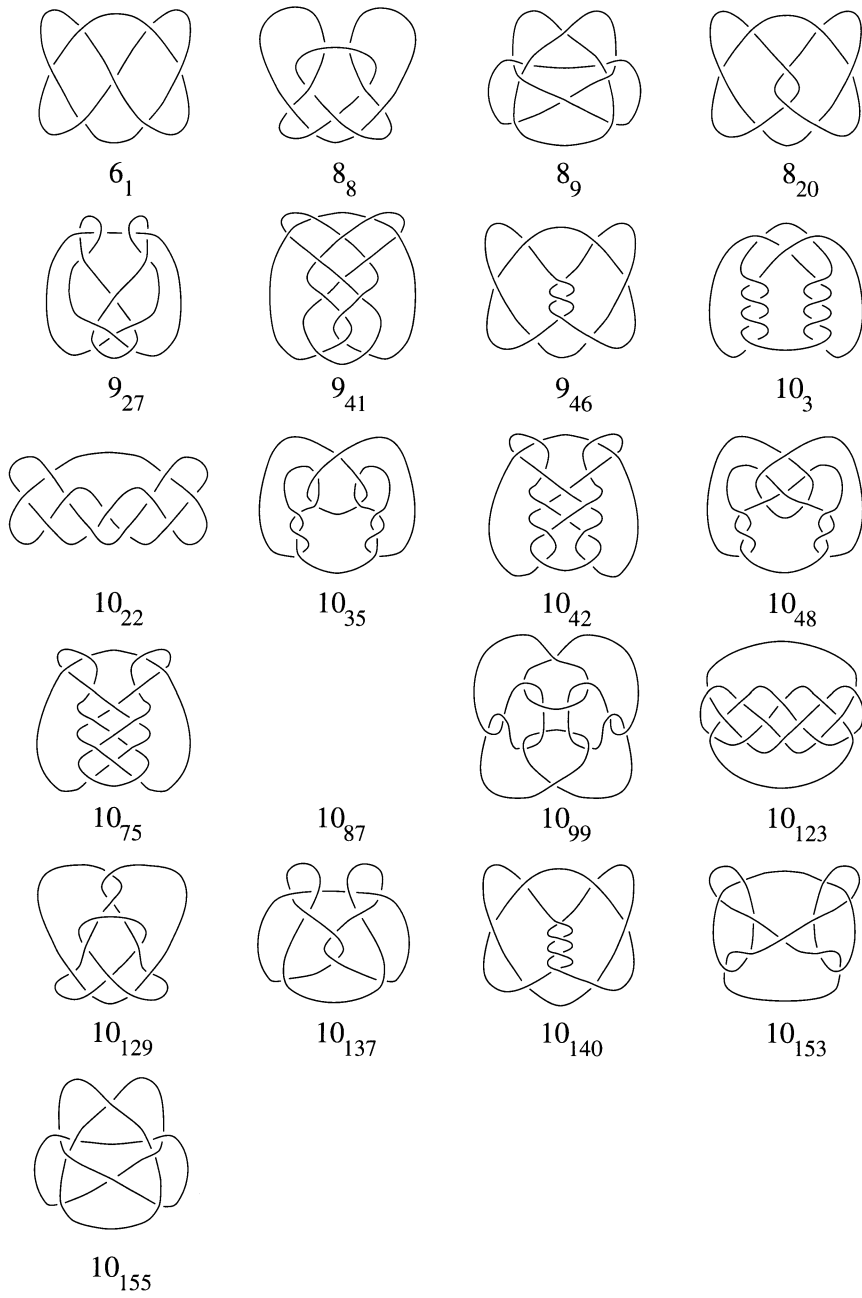

Fig. 16.

QUESTION 5.3. Are all ribbon links symmetric unions? Are all ribbon knots symmetric unions?

Fig. 16 contains the result of our attempt to find symmetric diagrams for all prime ribbon knots with minimal crossing number  $\leq 10$ . Some of them belong to the Fox-Milnor family [5] ( $6_1$ ,  $8_{20}$ ,  $9_{46}$ ,  $10_{140}$ ), the Kanenobu family [9] ( $8_8$ ,  $8_9$ ,  $10_{129}$ ,  $10_{137}$ ,  $10_{155}$ ) and the Kinoshita-Terasaka family ( $10_{153}$ ). These three families are shown in Fig. 15. We do not know if  $10_{87}$  is a symmetric union.

ACKNOWLEDGEMENT. I thank Michael Eisermann for his help and his contribution in Section 3.3.

---

### References

- [1] J.W. Alexander: *Topological invariants of knots and links*, Trans. Amer. Math. Soc. **30** (1928), 275–306.
- [2] J.S. Birman: *Braids, Links and Mapping Class Groups*, Ann. Math. Studies 84, Princeton Univ. Press, 1974.
- [3] M. Boileau and B. Zimmermann: *The  $\pi$ -orbifold Group of a Link*, Math. Zeitschrift **200**, 187–208 (1989).
- [4] T. Cochran: *Concordance invariance of coefficients of Conway's link polynomial*, Invent. Math. **82** (1985), 527–541.
- [5] R.H. Fox and J.W. Milnor: *Singularities of 2-spheres in 4-space and cobordism of knots*, Osaka J. Math. **3** (1966), 257–267.
- [6] R. Fukumoto and Y. Shinohara: *On the symmetric union of a trivial knot*, Kobe J. Math. **14** (1997), 123–132.
- [7] Y. Hashizume and F. Hosokawa: *On symmetric skew unions of knots*, Proc. Japan Acad. **34** (1958), 87–91.
- [8] J.A. Hillman: *Alexander ideals of links*, Lecture Notes in Math. 895, Springer Verlag, 1981.
- [9] T. Kanenobu: *Examples on polynomial invariants of knots and links*, Math. Ann. **275** (1986), 555–572.
- [10] T. Kanenobu: *Unions of knots as cross sections of 2-knots*, Kobe J. Math. **4** (1987), 147–162.
- [11] T. Kanenobu: *Examples on polynomial invariants of knots and links II*, Osaka J. Math. **26** (1989), 465–482.
- [12] A. Kawachi: *On the Alexander polynomials of cobordant links*, Osaka J. Math. **15** (1978), 151–159.
- [13] A. Kawachi: *A Survey of Knot Theory*, Birkhäuser, 1996.
- [14] R. Kawazoe and Y. Shinohara: *On the symmetric union of 2-bridge links*, Kwansai Gakuin Univ. Annual Stud. **44** (1996), 209–219.
- [15] S. Kinoshita and H. Terasaka: *On unions of knots*, Osaka J. Math. **9** (1957), 131–153.
- [16] C. Lamm and D. Obermeyer: *Billiard knots in a cylinder*, to appear in J. Knot Theory Ramifications.
- [17] W.B.R. Lickorish: *An Introduction to Knot Theory*, Graduate Texts 175, Springer, 1997.
- [18] J. Morgan and H. Bass: *The Smith conjecture*, Academic Press, 1984.
- [19] S. Sakai: *A generalization of symmetric unions of knots*, Bull. Educational Fac. Shizuoka Univ. **9** (1958), 117–121.
- [20] T. Sakai: *On the generalization of union of knots*, Hokkaido Math. J. **12** (1983), 129–146.

Mathematisches Institut,  
Beringstr. 1,  
53115 Bonn, Germany  
e-mail: [lamm@math.uni-bonn.de](mailto:lamm@math.uni-bonn.de)