

# A CHARACTERIZATION OF CONWAY-COXETER FRIEZES OF ZIGZAG TYPE BY RATIONAL LINKS

TAKEYOSHI KOGISO and MICHIHISA WAKUI

(Received August 21, 2020, revised January 4, 2021)

## Abstract

The present paper show that Conway-Coxeter friezes of zigzag type are characterized by (un-oriented) rational links. As an application of this characterization Jones polynomial can be defined for Conway-Coxeter friezes of zigzag type. This gives a new method for computing the Jones polynomial for oriented rational links.

In the precedent research [8] the authors found that some beautiful relation between frieze patterns due to Conway and Coxeter [4, 2, 3] and rational link diagrams. In that paper it is shown that Conway-Coxeter friezes of zigzag type are determined by 4-tuple of rational numbers which are related by  $\frac{p}{M}, \frac{q}{M}, \frac{r}{M}, \frac{s}{M}$ , where  $p, q, r, s, M$  are positive integers such that  $p + q = M = r + s$ . It is noteworthy that the numerators  $p, q, r, s$  are located around  $M$  in the corresponding Conway-Coxeter frieze to  $\frac{p}{M}$ . Moreover, it is shown in [8] that the Kauffman bracket polynomials of the rational link diagrams corresponding to  $\frac{p}{M}, \frac{q}{M}, \frac{r}{M}, \frac{s}{M}$  coincide up to replacing  $A$  with  $A^{-1}$ . This implies that the Kauffman bracket polynomials have meaning for Conway-Coxeter friezes of zigzag type. In the present paper we develop this consideration, and show that Conway-Coxeter friezes of zigzag type are characterized by (unoriented) rational links. We derive this characterization by reformulating the classification result on (unoriented) rational links by Schubert [14] in terms of the operations  $i(\frac{p}{M}) = \frac{q}{M}, r(\frac{p}{M}) = \frac{r}{M}, (ir)(\frac{p}{M}) = \frac{s}{M}$ , which are introduced in [8].

Any non-zero rational number is classified into three types such as  $\frac{0}{1}, \frac{1}{0}, \frac{1}{1}$ , that are determined by the parities of its numerator and denominator. We study in detail on types of non-zero rational numbers by language of Farey sums and continued fraction expansions. By using this result and applying the above characterization of Conway-Coxeter friezes of zigzag type, we introduce Jones polynomials for the Conway-Coxeter friezes of zigzag type. The key is to know difference between modified writhes of the four rational link diagrams corresponding to  $\frac{p}{M}, \frac{q}{M}, \frac{r}{M}, \frac{s}{M}$ . Recently, Nagai and Terashima [13] found a combinatorial formula to compute the writhes for oriented rational link diagrams in terms of continued fraction expansion. Their formula is described by some sign sequence determined from ancestor triangles of rational numbers, which are introduced by Hatcher and Ortel [6] or S. Yamada [15] in different backgrounds. We give a recursive formula for computing the sign sequence without geometric picture. Thus, the Jones polynomials for the Conway-Coxeter friezes of zigzag type can be computed from continued fraction expansions of rational numbers in a completely combinatorial way.

This also gives a new method for computing the Jones polynomial for oriented rational

links. Kyungyon Lee and Ralf Schiffler [9] gave an interesting formula to express Jones polynomials for rational links as specializations for cluster variables by using snake graphs. On the other hand, Sophie Morier-Genoud and Valentin Ovsienko [11] introduced a notion of  $q$ -deformed rational numbers and  $q$ -deformed continued fractions and applied to calculate normalized  $q$ -Jones polynomials as other approach of Lee and Schiffler’s result. Our formula on the Jones polynomials for the Conway-Coxeter friezes of zigzag type also gives a new method for computing the Jones polynomial for oriented rational links.

The present paper is organized as follows. In Section 1 we recall some notations of continued fraction expansions for rational numbers, Farey sums and  $LR$  words. Three important operations  $i, r, ir$  on  $LR$  words or equivalently on the rational numbers in the open interval  $(0, 1)$  are introduced. In Section 2 we briefly explain the definition of the Conway-Coxeter friezes of zigzag type, and effect of the operations  $i, r, ir$  on such friezes. In Section 3 we show that any Conway-Coxeter frieze of zigzag type can be regarded as an unoriented rational link. In Section 4, as an application of the result in Section 3, “Jones polynomial” for the Conway-Coxeter friezes of zigzag type can be defined. Furthermore, it is observed that each pair of rational knots such that their Jones polynomials are the same up to replacing  $t$  with  $t^{-1}$  has some common characteristic, which would be considered as a new phenomena. In the final section we derive a recurrence formula for computing the sign sequence which is used in the writhe formula of a rational link diagram due to Nagai and Terashima [13].

Throughout of the present paper,  $\mathbb{N}$  denotes the set of positive integers. On (rational) tangles, knots and links and their diagrams we refer the reader to Cromwell’s Book [5] and Murasugi’s Book [12].

### 1. Continued fraction expansions, Farey sums and $LR$ words

In the present paper, the denominator  $q$  of any irreducible fraction  $\frac{p}{q}$  is always assumed to be  $q \geq 0$ , and if  $q = 0$ , then  $p = 1$ .

Two irreducible fractions  $\frac{p}{q}$  and  $\frac{r}{s}$  are said to be *Farey neighbours* if they satisfy  $qr - ps = 1$ . Then  $\frac{p}{q} < \frac{r}{s}$  holds,  $\frac{p}{q} \# \frac{r}{s} := \frac{p+r}{q+s}$  is also irreducible, and both  $\frac{p}{q}, \frac{p}{q} \# \frac{r}{s}$  and  $\frac{p}{q} \# \frac{r}{s}, \frac{r}{s}$  are Farey neighbours, again. It is well-known that  $\frac{p}{q} \# \frac{r}{s}$  is the unique fraction that the absolute values of the numerator and the denominator are minimum between the numerators and the denominators of irreducible fractions in the open interval  $(\frac{p}{q}, \frac{r}{s})$ , respectively. It can be also verified that for any nonzero rational number  $\alpha$ , there is a unique pair  $(\frac{p}{q}, \frac{r}{s})$  of Farey neighbours which satisfies  $\alpha = \frac{p}{q} \# \frac{r}{s}$ . The pair  $(\frac{p}{q}, \frac{r}{s})$  is called the parents of  $\alpha$ , and  $\alpha$  is called the median of  $(\frac{p}{q}, \frac{r}{s})$ .

There is a one-to-one correspondence between the rational numbers in the open interval  $(0, 1)$  and the  $LR$  words as explained below. We denote the corresponding  $LR$  word by  $w(\alpha)$  for a rational number  $\alpha \in (0, 1)$ . Then, the function  $w(\alpha)$  is given by the following recurrence formula [8, Lemma 3.2]:

- $w(\frac{1}{2}) = \emptyset$ ,
- $w(\frac{p}{q} \# \frac{r}{s}) = \begin{cases} Lw(\frac{r}{s}) & \text{if } q < s, \\ Rw(\frac{p}{q}) & \text{if } q > s. \end{cases}$

EXAMPLE 1.1. (1)  $w(\frac{1}{3}) = w(\frac{0}{1}\#\frac{1}{2}) = Lw(\frac{1}{2}) = L$  and  $w(\frac{1}{4}) = w(\frac{0}{1}\#\frac{1}{3}) = Lw(\frac{1}{3}) = L^2$ . In general,  $w(\frac{1}{n}) = L^{n-2}$  for an integer  $n \geq 3$ .  
 (2)  $w(\frac{2}{3}) = w(\frac{1}{2}\#\frac{1}{1}) = Rw(\frac{1}{2}) = R$  and  $w(\frac{3}{4}) = w(\frac{1}{2}\#\frac{2}{3}) = Rw(\frac{2}{3}) = R^2$ . In general,  $w(\frac{n-1}{n}) = R^{n-2}$  for an integer  $n \geq 3$ .

REMARK 1.2. As explained in [8], the above correspondence can be visualized by using the Stern-Brocot tree as follows. Let  $\alpha \in \mathbb{Q} \cap (0, 1)$ . In the Stern-Brocot tree, starting from the vertex  $\frac{1}{2}$  we record  $L$  or  $R$  according to the left down or right down until reaching the vertex  $\alpha$  along edges, and arrange the sequence of  $L$  and  $R$  in the direction from right to left. This sequence coincides with  $w(\alpha)$ .

For an  $LR$  word  $w$  we denote by  $i(w)$  the word obtained by exchanging  $L$  and  $R$ , and by  $r(w)$  the word obtained by reversing the order. We also consider the word  $(ir)(w)$  obtained by composing  $i$  and  $r$ . Then we have the following.

**Lemma 1.3.** *Let  $\alpha = \frac{p}{q} \in \mathbb{Q} \cap (0, 1)$  be an irreducible fraction, and  $(\frac{x}{r}, \frac{y}{s})$  be the pair of parents of  $\alpha$ . If  $w = w(\frac{p}{q})$ , then*

- (1)  $i(w) = w(\frac{q-p}{q})$ ,
- (2)  $r(w) = w(\frac{r}{q})$ ,
- (3)  $(ir)(w) = w(\frac{s}{q})$ .

Based on the above result,  $i(\alpha), r(\alpha), (ir)(\alpha)$  are defined by  $i(\alpha) = \frac{q-p}{q}, r(\alpha) = \frac{r}{q}, (ir)(\alpha) = \frac{s}{q}$ , respectively.

For the proof of the above lemma see [8, Lemmas 3.5 and 3.8].

Let  $\alpha$  be a rational number, and expand it as a continued fraction

$$(1.1) \quad \alpha = a_0 + \frac{1}{a_1 + \frac{1}{a_2 + \frac{1}{\ddots + \frac{1}{a_{n-1} + \frac{1}{a_n}}}}}$$

where  $a_0 \in \mathbb{Z}, a_1, a_2, \dots, a_n \in \mathbb{N}$ . We denote the right-hand side of (1.1) by  $[a_0, a_1, a_2, \dots, a_n]$ . Note that the expansion (1.1) is unique if the parity of  $n$  is specified.

**Lemma 1.4.** *For a rational number  $\alpha = [0, a_1, a_2, \dots, a_n]$  in the open interval  $(0, 1)$*

- (1)  $i(\alpha) = [0, 1, a_1 - 1, a_2, \dots, a_n]$ .
- (2) *If  $n$  is even, then  $r(\alpha) = [0, 1, a_n - 1, a_{n-1}, \dots, a_2, a_1]$  and  $(ir)(\alpha) = [0, a_n, \dots, a_2, a_1]$ .*

Proofs of the above lemma can be found in [8, Corollary 3.7 and Lemma 3.11].

The rational numbers are classified into three types as follows. Let  $\alpha$  be a rational number, and express it as an irreducible fraction  $\alpha = \frac{p}{q}$ . We call  $\alpha$   $\frac{1}{1}$ -type if  $p \equiv 1, q \equiv 1 \pmod{2}$ . Similarly,  $\frac{1}{0}$ -type and  $\frac{0}{1}$ -type are defined. Let us define  $n(\alpha), d(\alpha) \in \{0, 1\}$  by the equations  $p \equiv n(\alpha), q \equiv d(\alpha) \pmod{2}$ . When  $\alpha$  is in the open interval  $(0, 1)$  and is expressed in the continued fraction form  $\alpha = [0, a_1, \dots, a_n]$  with  $n \geq 3$ , we set  $\alpha_0 := 0, \alpha_i = [0, a_1, \dots, a_i]$  for all  $i = 1, \dots, n$ . Then the following recurrence equations hold for all  $i \geq 2$ :

$$n(\alpha_i) = n(\alpha_{i-2}) + \frac{1 - (-1)^{\alpha_i}}{2} n(\alpha_{i-1}),$$

$$d(\alpha_i) = d(\alpha_{i-2}) + \frac{1 - (-1)^{\alpha_i}}{2} d(\alpha_{i-1}),$$

where these equations are treated in modulo 2.

**Lemma 1.5.** *Let  $\alpha = \frac{p}{q}$  be an irreducible fraction in  $(0, 1)$ , and let  $(\frac{x}{r}, \frac{y}{s})$  be the pair of parents of  $\alpha$ . We write in the continued fraction form  $\alpha = [0, a_1, \dots, a_n]$  for an even number  $n$ , and let  $N_0(a_1, \dots, a_n)$  be the number of even integers in  $a_1, \dots, a_n$ .*

- (1) *If  $\alpha$  is  $\frac{1}{0}$ -type, then*
  - $N_0(a_1, \dots, a_n)$  is even if and only if  $x$  is even,
  - $N_0(a_1, \dots, a_n)$  is odd if and only if  $y$  is even.
- (2) *If  $\alpha$  is  $\frac{1}{1}$ -type, then*
  - $N_0(a_1, \dots, a_n)$  is even if and only if  $y$  is even,
  - $N_0(a_1, \dots, a_n)$  is odd if and only if  $x$  is even.
- (3) *If  $\alpha$  is  $\frac{0}{1}$ -type, then  $x, y$  are odd, and*
  - $N_0(a_1, \dots, a_n)$  is even if and only if  $s$  is even,
  - $N_0(a_1, \dots, a_n)$  is odd if and only if  $r$  is even.

Proof. We show this lemma by induction on the numbers of Farey sum operation  $\#$  since any irreducible fraction in  $(0, 1)$  can be obtained from  $\frac{0}{1}$  and  $\frac{1}{1}$  by applying  $\#$ , repeatedly.

The rational number  $\frac{1}{2} = [0, 1, 1]$  is written by  $\frac{1}{2} = \frac{0}{1} \# \frac{1}{1}$ , and thus the lemma holds for  $\frac{1}{2}$ .

Next, suppose that the lemma holds for two rational numbers  $\beta, \gamma$  of Farey neighbours. Let us show the lemma for  $\alpha = \beta \# \gamma$ . We write in the form  $\alpha = [0, a_1, \dots, a_n]$  for some even number  $n$ .

(I) Let us consider the case  $a_n \geq 2$ . Then,

$$\beta = [0, a_1, \dots, a_n - 1] = \frac{x}{r}, \quad \gamma = [0, a_1, \dots, a_{n-1}] = \frac{y}{s}.$$

(i) Suppose that  $N_0(a_1, \dots, a_n)$  is even. Then  $N_0(a_1, \dots, a_n - 1)$  is odd.

If  $\beta$  is  $\frac{1}{1}$ -type and  $\gamma$  is  $\frac{0}{1}$ -type, then  $\alpha$  is  $\frac{1}{0}$ -type. By induction hypothesis,  $\beta$  is a Farey sum of rational numbers of  $\frac{0}{1}$ -type and  $\frac{1}{0}$ -type. Since

$$\beta = \begin{cases} [0, a_1, \dots, a_n - 2] \# [0, a_1, \dots, a_{n-1}] & \text{if } a_n \geq 3, \\ [0, a_1, \dots, a_{n-2}] \# [0, a_1, \dots, a_{n-1}] & \text{if } a_n = 2, \end{cases}$$

$\gamma = [0, a_1, \dots, a_{n-1}]$  is  $\frac{1}{0}$ -type. This is a contradiction. By the same manner, we have a contradiction when we suppose that  $\beta$  and  $\gamma$  are  $\frac{0}{1}$ -type and  $\frac{1}{0}$ -type, respectively, or that  $\beta$  and  $\gamma$  are  $\frac{1}{0}$ -type and  $\frac{1}{1}$ -type, respectively. Thus, the following three cases only occur.

- $\beta$  and  $\gamma$  are  $\frac{0}{1}$ -type and  $\frac{1}{1}$ -type, respectively. In this case  $\alpha$  is  $\frac{1}{0}$ -type, and  $x$  is even.
- $\beta$  and  $\gamma$  are  $\frac{1}{0}$ -type and  $\frac{0}{1}$ -type, respectively. In this case  $\alpha$  is  $\frac{1}{1}$ -type, and  $y$  is even.
- $\beta$  and  $\gamma$  are  $\frac{1}{1}$ -type and  $\frac{0}{1}$ -type, respectively. In this case  $\alpha$  is  $\frac{0}{1}$ -type, and  $s$  is even.

(ii) Suppose that  $N_0(a_1, \dots, a_n)$  is odd. Then  $N_0(a_1, \dots, a_n - 1)$  is even. By the same manner in Part (i), one can verify that the following three cases only occur.

- $\beta$  and  $\gamma$  are  $\frac{1}{1}$ -type and  $\frac{0}{1}$ -type, respectively. In this case  $\alpha$  is  $\frac{0}{1}$ -type, and  $y$  is even.
- $\beta$  and  $\gamma$  are  $\frac{0}{1}$ -type and  $\frac{1}{0}$ -type, respectively. In this case  $\alpha$  is  $\frac{1}{1}$ -type, and  $x$  is even.

- $\beta$  and  $\gamma$  are  $\frac{1}{0}$ -type and  $\frac{1}{1}$ -type, respectively. In this case  $\alpha$  is  $\frac{0}{1}$ -type, and  $r$  is even.

(II) Let us consider the case  $a_n = 1$ . Then,

$$\beta = [0, a_1, \dots, a_{n-2}] = \frac{x}{r}, \quad \gamma = [0, a_1, \dots, a_{n-1}] = \frac{y}{s}.$$

Suppose that  $N_0(a_1, \dots, a_n)$  is even. Then  $N_0(a_1, \dots, a_{n-1} - 1, 1)$  is odd.

If  $\beta$  is  $\frac{1}{1}$ -type and  $\gamma$  is  $\frac{0}{1}$ -type, then  $\alpha$  is  $\frac{1}{0}$ -type. By induction hypothesis,  $\gamma$  is a Farey sum of rational numbers of  $\frac{0}{1}$ -type and  $\frac{1}{0}$ -type. Since

$$\gamma = \begin{cases} [0, a_1, \dots, a_{n-2}] \# [0, a_1, \dots, a_{n-1} - 1] & \text{if } a_{n-1} \geq 2, \\ [0, a_1, \dots, a_{n-2}] \# [0, a_1, \dots, a_{n-3}] & \text{if } a_{n-1} = 1, \end{cases}$$

$\beta = [0, a_1, \dots, a_{n-2}]$  is  $\frac{0}{1}$ -type. This is a contradiction. By the same argument in Part (I), when  $N_0(a_1, \dots, a_n)$  is even, we see that the same result in (i) of (I) holds. It can be also verified that when  $N_0(a_1, \dots, a_n)$  is odd, the same result in (ii) of (I) holds. □

### 2. Conway-Coxeter friezes of zigzag type

A Conway-Coxeter frieze (abbreviated by CCF) [2, 3, 4] is an infinite array of positive integers, displayed on shifted lines such that the top and bottom lines are composed only of 1s, and each unit diamond

$$\begin{array}{ccc} & b & \\ a & & d \\ & c & \end{array}$$

in the array satisfies the determinant condition  $ad - bc = 1$ .

Given an  $LR$  word  $w$ , one can construct a Conway-Coxeter frieze  $\Gamma(w)$ . We will explain this construction by an example. Let  $w = L^2R^2L$ . Then, we set six 1s as in Figure 1 as an initial arrangement.

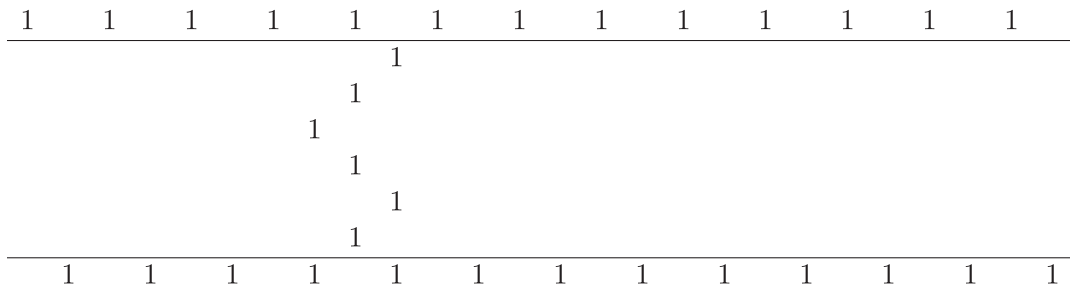

Fig. 1. an initial arrangement of 1s

The letters “ $L$ ” and “ $R$ ” correspond to going down to the left and the right in the zigzag path consisting of six 1s, respectively. Applying the rule  $ad - bc = 1$  repeatedly, we see that this initial arrangement generates a Conway-Coxeter frieze, which is given in Figure 2.

It is not true that every Conway-Coxeter frieze is constructed from some  $LR$  word. In fact, there is a Conway-Coxeter frieze such that a 1-zigzag line connecting the ceiling and the floor does not appear. It depends on whether a triangle with only a diagonal line appears

...	1	1	1	1	1	1	1	1	1	1	1	1	1	...
...	2	4	2	2	1	4	2	3	1	2	4	2	2	...
...	1	7	7	3	1	3	7	5	2	1	7	7	3	...
...	3	12	10	1	2	5	17	3	1	3	12	10	1	...
...	2	5	17	3	1	3	12	10	1	2	5	17	3	...
...	3	7	5	2	1	7	7	3	1	3	7	5	2	...
...	1	4	2	3	1	2	4	2	2	1	4	2	3	...
...	1	1	1	1	1	1	1	1	1	1	1	1	1	...

Fig. 2. the CCF corresponding to  $L^2R^2L$

in the triangulation of a polygon corresponding to a Conway-Coxeter frieze (see [8, Remark 3.10]).

In the present paper we only consider Conway-Coxeter friezes where 1-zigzag lines appear. Such a CCF is called a Conway-Coxeter frieze of *zigzag type*.

Any Conway-Coxeter frieze of zigzag type is constructed from some  $LR$  word as explained above. This means that the map  $w \mapsto \Gamma(w)$  is a surjection from the set of  $LR$  words to the set of Conway-Coxeter friezes of zigzag type. This map is not bijective since  $\Gamma((ir)(w))$  and  $\Gamma(w)$  are transformed by a horizontal translation and the reflection with respect to the middle horizontal line each other [4, 8, 10]. We consider that two CCFs are equivalent if they are transformed by the vertical or horizontal reflection or the composition of them.

Let  $\Gamma$  be a CCF of zigzag type. One can find the maximum number, say  $q$ , in  $\Gamma$ . If  $\Gamma = \Gamma(w(\alpha))$  for some  $\alpha \in \mathbb{Q} \cap (0, 1)$ , then the four numerators of  $\alpha, i(\alpha), r(\alpha), (ir)(\alpha)$  appear around  $q$  in  $\Gamma$ . For example, in the case where  $\Gamma$  is given by Figure 2, the maximum number is 17, and  $\alpha = \frac{7}{17}, i(\alpha) = \frac{10}{17}, r(\alpha) = \frac{12}{17}, (ir)(\alpha) = \frac{5}{17}$ , whose numerators appear around 17 in  $\Gamma$ . In this way, a Conway-Coxeter frieze of zigzag type is determined by the set  $\{w, i(w), r(w), (ir)(w)\}$  for an  $LR$  word  $w$ , or equivalently are determined by the set  $\{\alpha, i(\alpha), r(\alpha), (ir)(\alpha)\}$  for a rational number  $\alpha$  in the open interval  $(0, 1)$ .

### 3. A characterization of CCFs of zigzag type by rational links

Let  $\alpha$  be a rational number, and expand it as  $\alpha = [a_0, a_1, \dots, a_n]$  as a continued fraction, where  $a_0 \in \mathbb{Z}$  and  $a_1, \dots, a_n \in \mathbb{N}$ . Then a  $(2, 2)$ -tangle diagram  $T(\alpha)$  is defined as follows. If  $n$  is even, then

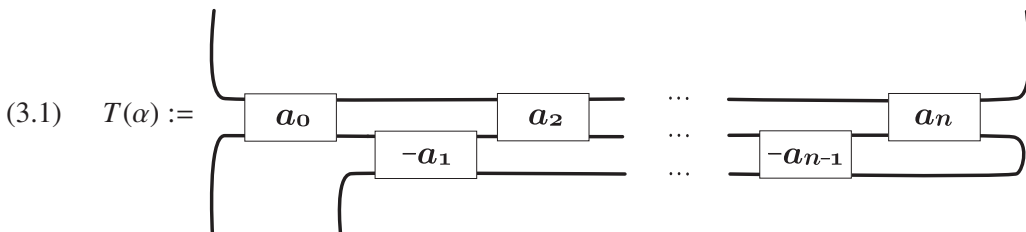

where

$$\boxed{n} = \begin{cases} \overleftarrow{n} \cdots \overrightarrow{n} & \text{if } n \geq 0, \\ \overleftarrow{-n} \cdots \overrightarrow{-n} & \text{if } n < 0. \end{cases}$$

If  $n$  is odd, then

$$(3.2) \quad T(\alpha) := \left( \begin{array}{c} \text{---} \boxed{a_0} \text{---} \boxed{a_2} \text{---} \cdots \boxed{a_{n-1}} \text{---} \\ \text{---} \boxed{-a_1} \text{---} \cdots \boxed{-a_n} \text{---} \end{array} \right).$$

The definition of  $T(\alpha)$  is well-defined since the diagram (3.1) for  $a_n \geq 2$  is regular isotopic to the diagram

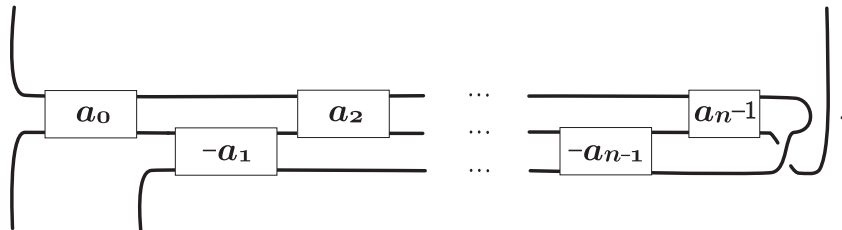

For a  $(2, 2)$ -tangle diagram  $T$  the denominator  $D(T)$  and the numerator  $N(T)$  are links obtained by closing the edge points as Figure 3. We frequently use the same symbols as their diagrams.

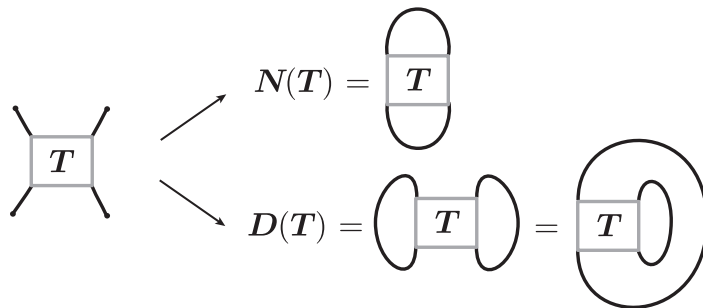

Fig.3. the denominator  $D(T)$  and the numerator  $N(T)$

A *rational link* or a *two-bridge link* is a link which is equivalent to the denominator of a rational tangle. Such links was classified by Schubert [14] in 1956. The unoriented version of the classification result is as follows.

**Theorem 3.1** (Schubert). *For rational numbers  $\alpha = \frac{p}{q}$  and  $\beta = \frac{p'}{q'}$ , the rational links  $D(T(\alpha))$  and  $D(T(\beta))$  are isotopic as unoriented links if and only if the following two conditions are satisfied:*

- (1)  $q = q'$ ,

(2)  $pp' \equiv 1 \pmod{q}$  or  $p \equiv p' \pmod{q}$ .

For a  $(2, 2)$ -tangle diagram  $T$ , we denote by  $\overline{T}$  the mirror image of  $T$ , that is obtained by changing over and under at all crossings. Theorem 3.1 can be reformulated in terms of the operations  $i, r, ir$  as follows.

**Theorem 3.2.** *Let  $\alpha = \frac{p}{q}$  ( $q \geq 2$ ) be a rational number in  $(0, 1)$ , and  $p' \in \{1, \dots, q-1\}$ . We set  $\beta = \frac{p'}{q}$ . Then the rational link  $D(T(\beta))$  is isotopic to  $D(T(\alpha))$  or  $D(\overline{T(\alpha)})$  as unoriented links if and only if  $\beta$  coincides with one of  $\alpha, i(\alpha), r(\alpha), (ir)(\alpha)$ .*

Proof. Let  $(\frac{x}{r}, \frac{y}{s})$  be the pair of parents of  $\alpha$ .

• If  $\beta = i(\alpha)$ , then  $\beta = \frac{q-p}{q}$  and  $q-p \equiv -p \pmod{q}$ . By Theorem 3.1,  $D(T(i(\alpha)))$  is isotopic to  $D(T(\frac{-p}{q})) = D(T(-\alpha)) = D(\overline{T(\alpha)})$  as unoriented links.

• If  $\beta = (ir)(\alpha)$ , then  $\beta = \frac{s}{q}$ . Since

$$ps = (x+y)s = ry - 1 + ys = -1 + (r+s)y = -1 + qy \equiv -1 \pmod{q},$$

it follows from Theorem 3.1 that  $D(T((ir)(\alpha)))$  is isotopic to  $D(T(\frac{-p}{q})) = D(T(-\alpha)) = D(\overline{T(\alpha)})$  as unoriented links.

• If  $\beta = r(\alpha)$ , then  $\beta = \frac{r}{q}$ . Since

$$pr = (x+y)r = xr + 1 + xs = x(r+s) + 1 = qx + 1 \equiv 1 \pmod{q}$$

it follows from Theorem 3.1 that  $D(T(r(\alpha)))$  is isotopic to  $D(T(\alpha))$  as unoriented links.

Conversely, assume that  $p' \in \{1, \dots, q-1\}$  satisfies  $pp' \equiv \pm 1 \pmod{q}$  or  $p \equiv \pm p' \pmod{q}$ .

• If  $pp' \equiv 1 \pmod{q}$ , then  $pp' = xq + 1$  for some  $x \in \mathbb{Z}$ . Since  $pp' > 0$  and  $p' < q$ , it follows that  $p > x \geq 0$ . Furthermore,  $\frac{p}{q} = \frac{x}{p'} \# \frac{p-x}{q-p'}$  and  $p'(p-x) - x(q-p') = p'p - xq = 1$ . Thus  $(\frac{x}{p'}, \frac{p-x}{q-p'})$  is the pair of parents of  $\alpha$ , and  $r(\alpha) = \frac{p'}{q}, (ir)(\alpha) = \frac{(q-p')}{q}$ .

• If  $pp' \equiv -1 \pmod{q}$ , then  $pp' = yq - 1$  for some  $y \in \mathbb{Z}$ . Since  $pp' > 0$  and  $p' < q$ , it follows that  $p > y \geq 0$ . Furthermore,  $\frac{p}{q} = \frac{p-y}{q-p'} \# \frac{y}{p'}$  and  $(q-p')y - (p-y)p' = qy - p'p = 1$ . Thus  $(\frac{p-y}{q-p'}, \frac{y}{p'})$  is the pair of parents of  $\alpha$ , and  $r(\alpha) = \frac{(q-p')}{q}, (ir)(\alpha) = \frac{p'}{q}$ .

• If  $p \equiv p' \pmod{q}$ , then  $p = p'$  since  $p, p' \in \{1, \dots, q-1\}$ . Therefore,  $\alpha = \frac{p'}{q}$ .

• If  $p \equiv -p' \pmod{q}$ , then  $q-p' \equiv p \pmod{q}$ . Since  $p' \in \{1, \dots, q-1\}$ , it follows that  $q-p' = p$ . Thus  $i(\alpha) = \frac{q-p}{q} = \frac{p'}{q}$ . □

As a corollary of Theorem 3.2 we have:

**Theorem 3.3.** *There is a one-to-one correspondence between the Conway-Coxeter friezes of zigzag-type and the sets of pairs of unoriented rational links  $\{D(T(\alpha)), D(\overline{T(\alpha)})\}$ .*

REMARK 3.4. For a  $(2, 2)$ -tangle diagram  $T$ , denote by  $T^{\text{in}}$  the new tangle diagram which is obtained by turning  $\overline{T}$  to 90 degree. If  $T = T(\alpha)$  for an  $\alpha = [0, a_1, \dots, a_n]$ , where  $n$  is even, then we see that as unoriented links

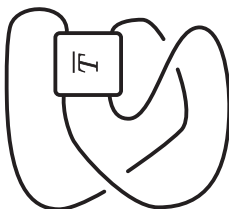
(3.3)  $D(T(i(\alpha))) \sim D((T^{\text{in}} \bowtie [-1]) * [1]) \sim$  



$$\sim \left( \begin{array}{c} \text{---} \\ \text{---} \\ \text{---} \\ \text{---} \end{array} \right) \sim D(\overline{T(\alpha)}),$$

where  $\sim$  means regular isotopic on the 2-dimensional sphere  $\mathbb{S}^2$ , and  $\bowtie$  and  $*$  mean the sum and the product operations on tangle diagrams, respectively. The equivalence (3.3) follows from Lemma 1.4(1) and the Conway’s classification result on rational tangles [1].

If we set  $T(\alpha)^{\text{pal}} := T([0, a_n, \dots, a_1])$ , called the palindrome of  $T(\alpha)$ , then

$$(3.4) \quad D(T((ir)(\alpha))) = D(T(\alpha)^{\text{pal}})$$

$$= \left( \begin{array}{c} \text{---} \\ \text{---} \\ \text{---} \\ \text{---} \end{array} \right) = D(\overline{T(\alpha)}).$$

See the proof of [8, Theorem 3.12] for (3.4).

From the above observation we also conclude that  $D(T(r(\alpha))) \sim D(T(\alpha))$ .

### 4. Jones polynomials for the CCFs of zigzag type

As an application of Theorem 3.3, in this section, we show that “Jones polynomial” for the CCFs of zigzag type can be defined. To describe the formulation we will need to introduce a convention of orientation for the rational links. Our convention is the completely same in [9].

Let  $\alpha = \frac{p}{q}$  be an irreducible fraction. Note that if  $q$  is odd, then the denominator  $D(T(\alpha))$  is a knot, and otherwise it is a two-component link. Moreover, we write  $\alpha = [0, a_1, \dots, a_n]$  for some  $a_1, \dots, a_n \in \mathbb{N}$ , and choose an orientation for  $D(T(\alpha))$  as follows.

- If  $q$  is odd and  $n$  is even, then

$$(4.1) \quad D(T(\alpha)) = \left( \begin{array}{c} \text{---} \\ \text{---} \\ \text{---} \\ \text{---} \end{array} \right).$$

- If  $q$  and  $n$  are even, then

$$(4.2) \quad D(T(\alpha)) = \left( \begin{array}{c} \text{---} \\ \text{---} \\ \text{---} \\ \text{---} \end{array} \right).$$

- If  $q$  and  $n$  are odd, then

$$(4.3) \quad D(T(\alpha)) = \left( \begin{array}{c} \text{---} \\ \text{---} \\ \text{---} \\ \text{---} \end{array} \right).$$

- If  $q$  is even and  $n$  is odd, then

$$(4.4) \quad D(T(\alpha)) = \left( \begin{array}{c} \text{---} \\ \text{---} \\ \text{---} \\ \text{---} \end{array} \right).$$

We denote by  $wr(\alpha)$  the writhe of  $D(T(\alpha))$  with the above orientation.

If  $D(T(\alpha))$  is a two-component link, namely  $\alpha$  is  $\frac{1}{0}$ -type, then we have another orientation for  $D(T(\alpha))$  by changing the given orientation. We denote by  $D_{+-}(T(\alpha))$ ,  $D_{--}(T(\alpha))$ ,  $D_{-+}(T(\alpha))$  the obtained links with the following new orientations, respectively. If  $n$  is chosen as even, then

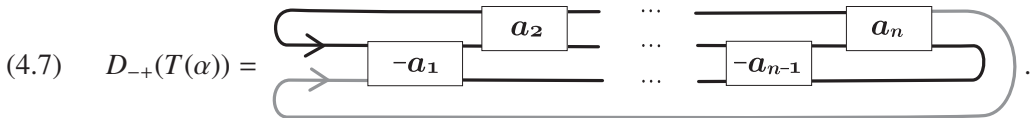
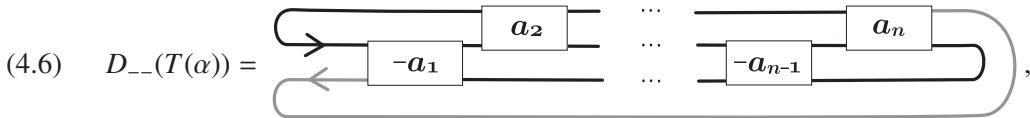
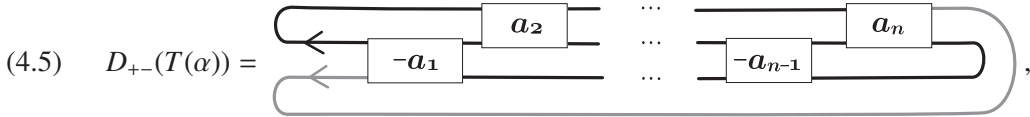

In the case where  $n$  is chosen as odd, they are defined by similar oriented diagrams.

We denote by  $wr_{+-}(\alpha)$ ,  $wr_{--}(\alpha)$ ,  $wr_{-+}(\alpha)$  the writhes of  $D_{+-}(T(\alpha))$ ,  $D_{--}(T(\alpha))$ ,  $D_{-+}(T(\alpha))$ , respectively.

**Lemma 4.1.** *Let  $\alpha = [0, a_1, a_2, \dots, a_n]$  be a rational number in  $(0, 1)$  of type  $\frac{1}{0}$ .*

- (1) *Assume that  $n$  is even. If  $N_0(a_1, \dots, a_n)$  is even, then the oriented diagram  $D_{+-}(T(\alpha))$  is regular isotopic to  $D(\overline{T((ir)(\alpha)})}$ . If  $N_0(a_1, \dots, a_n)$  is odd, then  $D_{+-}(T(\alpha))$  is regular isotopic to  $D_{-+}(\overline{T((ir)(\alpha)})}$  with orientation. Therefore,*

$$wr_{+-}(\alpha) = \begin{cases} -wr((ir)(\alpha)) & \text{if } N_0(a_1, \dots, a_n) \text{ is even,} \\ -wr_{-+}((ir)(\alpha)) & \text{if } N_0(a_1, \dots, a_n) \text{ is odd.} \end{cases}$$

- (2) *Assume that  $n$  is even. If  $N_0(a_1, \dots, a_n)$  is even, then the oriented diagram  $D_{--}(T(\alpha))$  is regular isotopic to  $D_{-+}(\overline{T((ir)(\alpha)})}$ . If  $N_0(a_1, \dots, a_n)$  is odd, then  $D_{--}(T(\alpha))$  is regular isotopic to  $D(\overline{T((ir)(\alpha)})}$  with orientation. Therefore,*

$$wr(\alpha) = \begin{cases} -wr_{-+}((ir)(\alpha)) & \text{if } N_0(a_1, \dots, a_n) \text{ is even,} \\ -wr((ir)(\alpha)) & \text{if } N_0(a_1, \dots, a_n) \text{ is odd.} \end{cases}$$

- (3) *The oriented diagram  $D(T(\alpha))$  is regular isotopic to  $D_{-+}(\overline{T(i(\alpha))}$  with orientation, and therefore*

$$wr(\alpha) = -wr_{-+}(i(\alpha)).$$

Proof. By Lemma 1.4  $(ir)(\alpha) = [0, a_n, \dots, a_2, a_1]$ .

For an even integer  $n$ , let  $B(\alpha)$  be the following 3-braid:

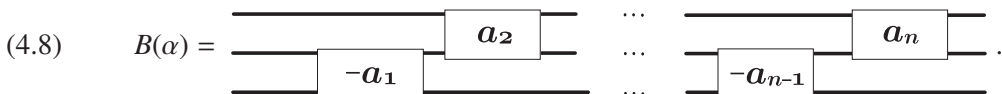

Assume that the both three terminal points of  $B(\alpha)$  are numbered as 1, 2, 3 beginning at the top. When the  $j$ th terminal point on the left is connected with the  $i_j$ th terminal point on the right by a strand of  $B(\alpha)$ , we set

$$\sigma(\alpha) := \begin{pmatrix} 1 & 2 & 3 \\ i_1 & i_2 & i_3 \end{pmatrix}.$$

The diagram  $D(T(\alpha))$  has two-component if and only if the number 3 is sent to the number 1 under this permutation  $\sigma(\alpha)$ .

(1) If the number  $N_0(a_1, \dots, a_n)$  is even, then  $\sigma(\alpha)$  sends 1 to 2. The oriented diagram  $D_{+-}(T(\alpha))$  can be deformed as

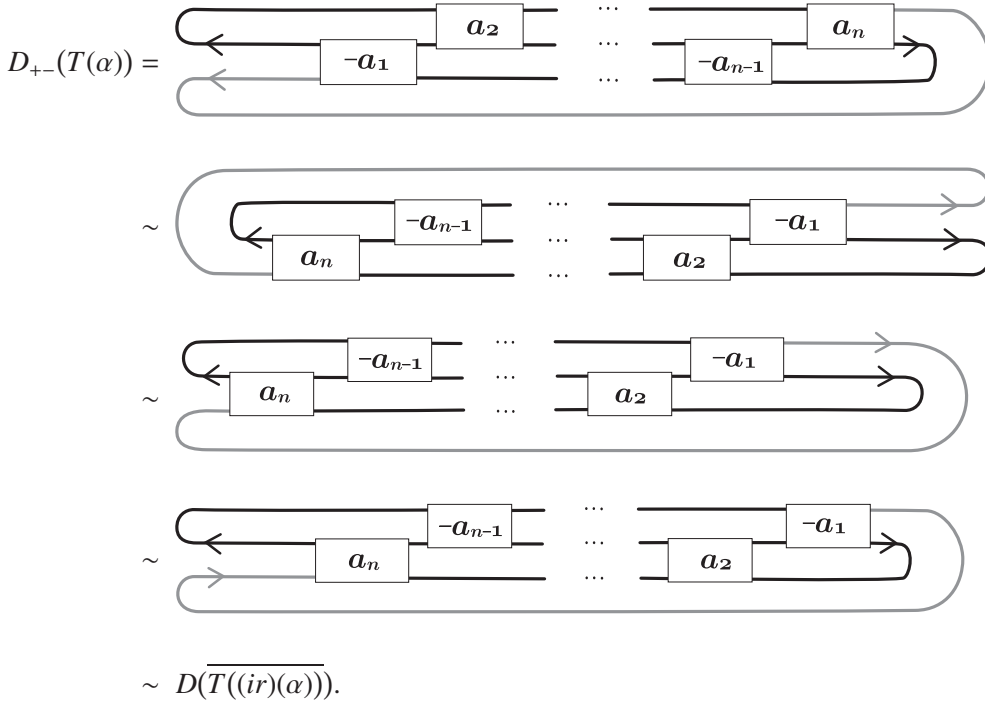

Thus we have

$$\text{wr}_{+-}(\alpha) = \text{wr}(D(\overline{T((ir)(\alpha))})) = -\text{wr}((ir)(\alpha)).$$

If  $N_0(a_1, \dots, a_n)$  is odd, then  $\sigma(\alpha)$  sends 1 to 3. By deforming  $D_{+-}(T(\alpha))$  in the same manner, we have

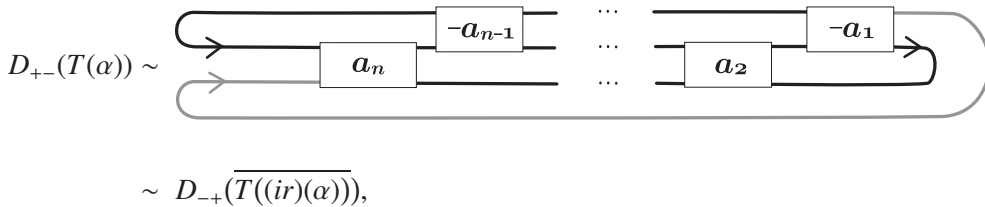

and hence

$$\text{wr}_{+-}(\alpha) = \text{wr}(D_{-+}(\overline{T((ir)(\alpha))})) = \text{wr}(D_{+-}(\overline{T((ir)(\alpha))})) = -\text{wr}_{+-}((ir)(\alpha)).$$

(2) By the same method if  $N_0(a_1, \dots, a_n)$  is even, then  $D_{--}(T(\alpha)) \sim D_{-+}(\overline{T((ir)(\alpha))})$ , and

hence

$$\text{wr}(\alpha) = \text{wr}_{--}(\alpha) = \text{wr}\left(D_{-+}(\overline{T((ir)(\alpha))})\right) = -\text{wr}_{+-}((ir)(\alpha)).$$

If  $N_0(a_1, \dots, a_n)$  is odd, then  $D_{--}(T(\alpha)) \sim D(\overline{T((ir)(\alpha))})$ , and hence

$$\text{wr}(\alpha) = \text{wr}_{--}(\alpha) = -\text{wr}((ir)(\alpha)).$$

(3) Assume that  $a_n \geq 2$ . By Lemma 1.4,  $i(\alpha) = [0, 1, a_1 - 1, a_2, \dots, a_n]$ .

If  $n$  is even, then

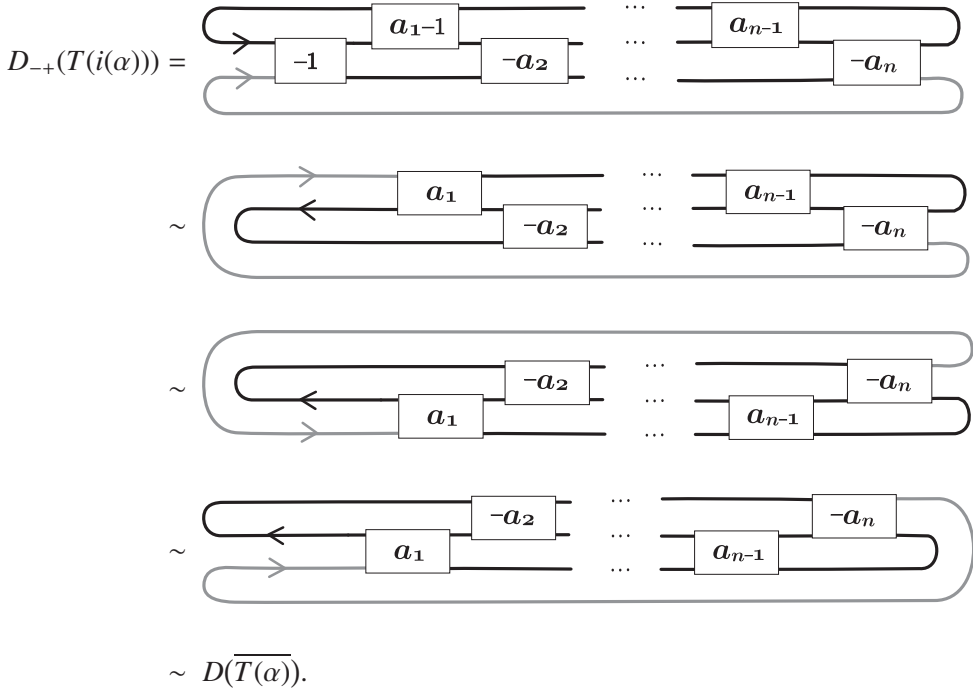

Thus  $D_{-+}(\overline{T(i(\alpha))}) \sim D(T(\alpha))$ , and therefore  $\text{wr}(\alpha) = -\text{wr}_{+-}(i(\alpha)) = -\text{wr}_{+-}((ir)(\alpha))$ .

In the case where  $n$  is odd, applying the same method we have the same result. □

**Lemma 4.2.** *Let  $\alpha = \frac{p}{q}$  be a rational number in  $(0, 1)$ , and assume that  $q$  is odd. Then*

$$\text{wr}(\alpha) = \text{wr}((ir)(\alpha)) = -\text{wr}(i(\alpha)).$$

*Proof.* Since  $q$  is odd,  $D(T(i(\alpha)))$  is a knot diagram. So,  $D(T(i(\alpha))) \sim D(\overline{T(\alpha)})$  and  $\text{wr}(\alpha) = -\text{wr}(i(\alpha))$ .

Let  $D_{-}(T(\alpha))$  be the oriented diagram  $D(T(\alpha))$  with the opposite orientation. By a similar manner in the proof of Lemma 4.1(1),  $D_{-}(T(\alpha))$  is regular isotopic to  $D(T((ir)(\alpha)))$ . It follows that  $\text{wr}(\alpha) = \text{wr}(D_{-}(T(\alpha))) = -\text{wr}((ir)(\alpha))$ . □

Let  $V(\alpha)$  be the Jones polynomial of the oriented link given by the diagram  $D(T(\alpha))$  with orientation given by (4.1) – (4.4). Then

$$(4.9) \quad V(\alpha) = (-A^3)^{-\text{wr}(\alpha)} \langle D(T(\alpha)) \rangle,$$

where the bracket  $\langle \ \rangle$  means the Kauffman bracket polynomial [7], which is a Laurent

polynomial in variable  $A$  with integer coefficient and is defined by the following axioms.

$$(KB1) \langle \diagdown \diagup \rangle = A \langle \rangle \langle \rangle + A^{-1} \langle \diagup \diagdown \rangle$$

$$(KB2) \langle D \sqcup \bigcirc \rangle = \delta \langle D \rangle, \text{ where } \delta = -A^2 - A^{-2}.$$

$$(KB3) \langle \bigcirc \rangle = 1.$$

(KB4)  $\langle D \rangle$  is a regular isotopy invariant of  $D$ , that is, it is invariant under Reidemeister moves II and III.

The Kauffman bracket polynomials for Conway-Coxeter friezes of zigzag-type are introduced in [8]. To describe it, we use the weight  $wt(\alpha)$  for a positive rational number  $\alpha$  which is defined as follows. Express  $\alpha$  as  $\alpha = [a_0, a_1, \dots, a_n]$  such that  $a_0$  is a non-negative integer and  $a_1, \dots, a_n$  are positive integers, and set

$$(4.10) \quad wt(\alpha) = \begin{cases} a_0 - a_1 + a_2 - \dots + a_n & \text{if } n \text{ is even,} \\ a_0 - a_1 + a_2 - \dots - a_n + 2 & \text{if } n \text{ is odd.} \end{cases}$$

It can be easily shown that  $wt(\alpha)$  is well-defined.

For the Conway-Coxeter frieze  $\Gamma_\alpha$  corresponding to a rational number  $\alpha$  in  $(0, 1)$ , the Kauffman bracket polynomial  $\langle \Gamma_\alpha \rangle$  is given by the formula (see [8, Theorem 2.10, Equation (2.7)]):

$$(4.11) \quad \langle \Gamma_\alpha \rangle = (-A^3)^{wt(\alpha)} \langle D(T(\alpha)) \rangle.$$

Let us introduce the extended weight  $\widetilde{wt}(\alpha)$  by

$$(4.12) \quad \widetilde{wt}(\alpha) = -wr(\alpha) - wt(\alpha).$$

Combining (4.11) and (4.9) we have:

**Proposition 4.3.** *For a rational number  $\alpha$  in  $(0, 1)$ , the Jones polynomial  $V(\alpha)$  of the rational link  $D(T(\alpha))$  is given by*

$$(4.13) \quad V(\alpha) = (-A^3)^{\widetilde{wt}(\alpha)} \langle \Gamma_\alpha \rangle.$$

REMARK 4.4. Nagai and Terashima [13, Theorem 4.4] found a combinatorial formula for the writhe  $wr(\alpha)$ . If we write in the form  $\alpha = [0, a_1, \dots, a_n]$  by some  $a_1, \dots, a_n \in \mathbb{N}$ , then the writhe is given by

$$(4.14) \quad -wr(\alpha) = \sum_{j=1}^n t_\alpha(\Delta_j) a_j.$$

Here,  $\{\Delta_1, \dots, \Delta_n\}$  is the sequence of triangles determined by the continued fraction expansion  $\alpha = [0, a_1, \dots, a_n]$ , and  $t_\alpha(\Delta_j)$  is a sign of  $\Delta_j$  determined as follows.

$$t_\alpha(\Delta_1) = \begin{cases} 1 & \text{if } \alpha \text{ is } \frac{1}{0} \text{ or } \frac{0}{1}\text{-type,} \\ -1 & \text{if } \alpha \text{ is } \frac{1}{1}\text{-type,} \end{cases}$$

$$t_\alpha(\Delta_j) = \begin{cases} -t_\alpha(\Delta_{j-1}) & \text{if the Seifert path of } \alpha \text{ goes through between } \Delta_{j-1} \text{ and } \Delta_j, \\ t_\alpha(\Delta_{j-1}) & \text{otherwise.} \end{cases}$$

More direct recursive formula is given in the last section. Thus, the extended weight  $\widetilde{wt}(\alpha)$  is computable in a purely combinatorial way.

If a rational number  $\alpha$  is  $\frac{1}{0}$ -type, then we define  $\widetilde{\text{wt}}_{+-}(\alpha)$  by

$$(4.15) \quad \widetilde{\text{wt}}_{+-}(\alpha) := -\text{wr}_{+-}(\alpha) - \text{wt}(\alpha).$$

**Lemma 4.5.** *Let  $p, q$  be coprime integers satisfying with  $0 < p < q$ , and  $(\frac{x}{s}, \frac{y}{r})$  be the pair of parents of  $\alpha = \frac{p}{q}$ .*

(1) *If  $q$  is odd, then*

$$\widetilde{\text{wt}}(i(\alpha)) = \widetilde{\text{wt}}((ir)(\alpha)) = -\widetilde{\text{wt}}(\alpha), \quad \widetilde{\text{wt}}(r(\alpha)) = \widetilde{\text{wt}}(\alpha).$$

(2) *If  $q$  and  $x$  are even, then*

$$\widetilde{\text{wt}}(i(\alpha)) = \widetilde{\text{wt}}((ir)(\alpha)) = -\widetilde{\text{wt}}_{+-}(\alpha), \quad \widetilde{\text{wt}}(r(\alpha)) = \widetilde{\text{wt}}(\alpha).$$

(3) *If  $q$  and  $y$  are even, then*

$$\widetilde{\text{wt}}(i(\alpha)) = -\widetilde{\text{wt}}_{+-}(\alpha), \quad \widetilde{\text{wt}}((ir)(\alpha)) = -\widetilde{\text{wt}}(\alpha), \quad \widetilde{\text{wt}}(r(\alpha)) = \widetilde{\text{wt}}_{+-}(\alpha).$$

Proof. Let  $\alpha$  express as a continued fraction  $\alpha = [0, a_1, \dots, a_n]$ , where  $n$  is even.

(1) If  $q$  is odd, then by Lemma 4.2,  $\text{wr}(i(\alpha)) = -\text{wr}(\alpha)$ . Since  $n$  is even,  $i(\alpha) = [0, 1, a_1 - 1, a_2, \dots, a_n]$  and

$$\text{wt}(i(\alpha)) = -1 + (a_1 - 1) + \sum_{k=2}^n (-1)^k a_k = -\sum_{k=1}^n (-1)^{k-1} a_k = -\text{wt}(\alpha).$$

Thus, we have

$$\widetilde{\text{wt}}(i(\alpha)) = -\text{wr}(i(\alpha)) - \text{wt}(i(\alpha)) = \text{wr}(\alpha) + \text{wt}(\alpha) = -\widetilde{\text{wt}}(\alpha).$$

By the same manner, since  $\text{wr}((ir)(\alpha)) = -\text{wr}(\alpha)$  and  $\text{wt}((ir)(\alpha)) = -\text{wt}(\alpha)$ , it follows that  $\widetilde{\text{wt}}((ir)(\alpha)) = -\widetilde{\text{wt}}(\alpha)$ .

If we set  $\beta = (ir)(\alpha)$ , then  $r(\alpha) = i(\beta)$ , and hence

$$\text{wr}(r(\alpha)) = \text{wr}(i(\beta)) = -\text{wr}(\beta) = -\text{wr}((ir)(\alpha)) = \text{wr}(\alpha).$$

Since  $n$  is even,  $r(\alpha) = [0, 1, a_n - 1, a_{n-1}, \dots, a_1]$  and

$$\text{wt}(r(\alpha)) = -1 + (a_n - 1) + \sum_{k=2}^n (-1)^{k-1} a_{n-k+1} + 2 = a_n - \sum_{k=1}^{n-2} (-1)^{n-k+1} a_k = \sum_{k=1}^n (-1)^k a_k = \text{wt}(\alpha).$$

Thus, we have  $\widetilde{\text{wt}}(r(\alpha)) = \widetilde{\text{wt}}(\alpha)$ .

(2) Since  $q$  is even,  $\text{wr}(i(\alpha)) = -\text{wr}_{+-}(\alpha)$  by Lemma 4.1(3). Since  $n$  is even, as the proof of Part (1) one can show that  $\text{wt}(i(\alpha)) = -\text{wt}(\alpha)$ . Thus,  $\widetilde{\text{wt}}(i(\alpha)) = -\widetilde{\text{wt}}_{+-}(\alpha)$ .

Since  $n$  is even, as the proof of Part (1) one can show that  $\text{wt}((ir)(\alpha)) = -\text{wt}(\alpha)$ .

If  $x$  is even, then  $N_0(a_1, \dots, a_n)$  is also even by Lemma 1.5. Thus,  $\text{wr}((ir)(\alpha)) = -\text{wr}_{+-}(\alpha)$  by Lemma 4.1(1), and therefore,

$$\widetilde{\text{wt}}((ir)(\alpha)) = \text{wr}_{+-}(\alpha) + \text{wt}(\alpha) = -\widetilde{\text{wt}}_{+-}(\alpha).$$

If we set  $\beta = (ir)(\alpha)$ , then  $r(\alpha) = i(\beta)$ , and hence

$$\text{wr}(r(\alpha)) = \text{wr}(i(\beta)) = -\text{wr}_{+-}(\beta)$$

by Lemma 4.1(3). Since  $\beta = \frac{s}{q} = [0, a_n, \dots, a_2, a_1]$  is of type  $\frac{1}{0}$  and  $N_0(a_n, \dots, a_1)$  is even, it follows that

$$\text{wr}(\beta) = -\text{wr}_{+-}((ir)(\beta)) = -\text{wr}_{+-}(\alpha)$$

by Lemma 4.1(1). Thus,  $\text{wr}(r(\alpha)) = \text{wr}(\alpha)$ . Since  $n$  is even,

$$\text{wt}(r(\alpha)) = -1 + (a_n - 1) + \sum_{k=2}^n (-1)^{k-1} a_{n-k+1} + 2 = a_n - \sum_{k=1}^{n-2} (-1)^{n-k+1} a_k = \sum_{k=1}^n (-1)^k a_k = \text{wt}(\alpha),$$

and hence

$$\widetilde{\text{wt}}(r(\alpha)) = -\text{wr}(\alpha) - \text{wt}(\alpha) = \widetilde{\text{wt}}(\alpha).$$

Part (3) can be shown by the same manner in the proof of Parts (1) and (2). □

**Theorem 4.6.** *Let  $p, q$  be coprime integers satisfying with  $0 < p < q$ , and  $(\frac{x}{s}, \frac{y}{r})$  be the pair of parents of  $\alpha = \frac{p}{q}$ . Then,*

$$(4.16) \quad (\langle \Gamma_\alpha \rangle, \langle \Gamma_{i(\alpha)} \rangle, \langle \Gamma_{r(\alpha)} \rangle, \langle \Gamma_{(ir)(\alpha)} \rangle) = (\langle \Gamma_\alpha \rangle, \overline{\langle \Gamma_\alpha \rangle}, \langle \Gamma_\alpha \rangle, \overline{\langle \Gamma_\alpha \rangle})$$

holds, where  $\overline{\langle \Gamma_\alpha \rangle}$  denotes the Laurent polynomial obtained from  $\langle \Gamma_\alpha \rangle$  by replacing  $A$  with  $A^{-1}$ . Furthermore,

(1) *If  $q$  is odd, then*

$$\begin{aligned} V(i(\alpha)) &= V((ir)(\alpha)) = \overline{V(\alpha)}, \\ V(r(\alpha)) &= V(\alpha). \end{aligned}$$

(2) *If  $q$  and  $x$  are even, then*

$$\begin{aligned} V(i(\alpha)) &= V((ir)(\alpha)) = (-A^3)^{-\text{wr}(\alpha) - \text{wr}(i(\alpha))} \overline{V(\alpha)}, \\ V(r(\alpha)) &= V(\alpha). \end{aligned}$$

(3) *If  $q$  and  $y$  are even, then*

$$\begin{aligned} V(i(\alpha)) &= (-A^3)^{-\text{wr}(\alpha) - \text{wr}(i(\alpha))} \overline{V(\alpha)}, \\ V((ir)(\alpha)) &= \overline{V(\alpha)}, \\ V(r(\alpha)) &= (-A^3)^{\text{wr}(\alpha) + \text{wr}(i(\alpha))} V(\alpha). \end{aligned}$$

Proof. The equation (4.16) has already shown in [8, Theorems 3.12 and 3.15]. The rest of all equations can be easily obtained from (4.13), Lemmas 4.1 and 4.5. □

**REMARK 4.7.** In the case where  $q$  is even, we may consider the Jones polynomial  $V_{+-}(\alpha)$  of the rational link  $D_{+-}(T(\alpha))$ . By Lemma 4.1(3),  $D_{+-}(T(\alpha))$  is isotopic to  $D_{--}(\overline{T(i(\alpha))})$  as an oriented link. This implies that

$$(4.17) \quad V_{+-}(\alpha) = \overline{V(i(\alpha))}.$$

**Corollary 4.8.** *For a Conway-Coxeter frieze  $\Gamma$  of zigzag-type, we choose a rational number  $\alpha$  in the open interval  $(0, 1)$  such that  $\Gamma = \Gamma_\alpha$ , and  $(\frac{x}{s}, \frac{y}{r})$  be the pair of parents of  $\alpha = \frac{p}{q}$ . Define the equivalence class  $V(\Gamma)$  by*

$$(4.18) \quad V(\Gamma) := \begin{cases} V(\alpha) \equiv \overline{V(\alpha)} & \text{if } q \text{ is odd,} \\ V(\alpha) \equiv V(i(\alpha)) & \text{if } q \text{ and } x \text{ are even,} \\ V(\alpha) \equiv V(i(\alpha)) \equiv \overline{V(i(\alpha))} \equiv \overline{V(\alpha)} & \text{if } q \text{ and } y \text{ are even.} \end{cases}$$

Then  $V(\Gamma)$  is well-defined. We treat  $V(\Gamma)$  as a Laurent polynomial in variable  $t^{\frac{1}{2}}$  by substituting  $t = A^{-4}$ , and call it the Jones polynomial of the Conway-Coxeter frieze  $\Gamma$ .

EXAMPLE 4.9. (1) When  $\alpha = \frac{1}{4}$ , by Lemma 1.3,  $i(\frac{1}{4}) = \frac{3}{4}$ ,  $r(\frac{1}{4}) = \frac{1}{4}$ ,  $(ir)(\frac{1}{4}) = \frac{3}{4}$ . Since the pair of parents of  $\alpha$  is  $(\frac{0}{1}, \frac{1}{3})$ , by Theorem 4.6(2), we see that

$$(V(\alpha), V(i(\alpha)), V(r(\alpha)), V((ir)(\alpha))) = (V(\alpha), \overline{V_{+-}(\alpha)}, V(\alpha), \overline{V_{+-}(\alpha)}).$$

Since  $\alpha = [0, 4]$  and  $i(\alpha) = [0, 1, 3]$ ,  $wr(\alpha) = wr(i(\alpha)) = 4$ . So,  $wr(\alpha) + wr(i(\alpha)) = 8$  and  $V(\frac{1}{4}) = t^{\frac{3}{2}}(-t^3 - t + 1 - t^{-1})$ . Thus

$$V(\Gamma_{\frac{1}{4}}) \equiv t^{\frac{3}{2}}(-t^3 - t + 1 - t^{-1}) \equiv t^{\frac{9}{2}}(-t^{-3} - t^{-1} + 1 - t).$$

Indeed,  $V(\frac{3}{4}) = t^{\frac{3}{2}}(-t^{-3} - t^{-1} + 1 - t) = t^6 \overline{V(\frac{1}{4})}$ .

(2) When  $\alpha = \frac{3}{10}$ , by Lemma 1.3,  $i(\frac{3}{10}) = \frac{7}{10}$ ,  $r(\frac{3}{10}) = \frac{7}{10}$ ,  $(ir)(\frac{3}{10}) = \frac{3}{10}$ . Since the pair of parents of  $\alpha$  is  $(\frac{2}{7}, \frac{1}{3})$ , by Theorem 4.6(2), we see that

$$(V(\alpha), V(i(\alpha)), V(r(\alpha)), V((ir)(\alpha))) = (V(\alpha), \overline{V_{+-}(\alpha)}, V(\alpha), \overline{V_{+-}(\alpha)}).$$

Since  $\alpha = [0, 3, 3]$  and  $i(\alpha) = [0, 1, 2, 3]$ ,  $wr(\alpha) = wr(i(\alpha)) = 6$ . So,  $wr(\alpha) + wr(i(\alpha)) = 12$  and  $V(\frac{3}{10}) = t^{\frac{9}{2}}(-t^3 + t^2 - 2t + 2 - 2t^{-1} + t^{-2} - t^{-3})$ . In this case  $V(\frac{7}{10}) = t^9 \overline{V(\frac{3}{10})} = V(\frac{3}{10})$ , and hence

$$V(\Gamma_{\frac{3}{10}}) \equiv t^{\frac{9}{2}}(-t^3 + t^2 - 2t + 2 - 2t^{-1} + t^{-2} - t^{-3}).$$

The result  $V(\frac{7}{10}) = V(\frac{3}{10})$  is confirmed by  $3 \cdot 7 \equiv 1 \pmod{2 \cdot 10}$ . Because, by Schubert's classification theorem for the rational links with orientation [14], the congruent equation implies that two oriented links  $D(T(\frac{3}{10}))$  and  $D(T(\frac{7}{10}))$  are isotopic.

(3) When  $\alpha = \frac{3}{14}$ , by Lemma 1.3,  $i(\frac{3}{14}) = \frac{11}{14}$ ,  $r(\frac{3}{14}) = \frac{5}{14}$ ,  $(ir)(\frac{3}{14}) = \frac{9}{14}$ . Since the pair of parents of  $\alpha$  is  $(\frac{1}{5}, \frac{2}{9})$ , by Theorem 4.6(2), we see that

$$(V(\alpha), V(i(\alpha)), V(r(\alpha)), V((ir)(\alpha))) = (V(\alpha), \overline{V_{+-}(\alpha)}, V_{+-}(\alpha), \overline{V(\alpha)}).$$

Since  $\alpha = [0, 4, 1, 2]$  and  $i(\alpha) = [0, 1, 3, 1, 2]$ ,  $wr(\alpha) = 1$ ,  $wr(i(\alpha)) = 3$ . So,  $wr(\alpha) + wr(i(\alpha)) = 4$ . By computation we have

$$\begin{aligned} V(\frac{3}{14}) &= t^{-\frac{3}{2}}(-t^5 + t^4 - 2t^3 + 2t^2 - 3t + 2 - 2t^{-1} + t^{-2}), \\ V(\frac{11}{14}) &= t^{\frac{9}{2}}(t^2 - 2t + 2 - 3t^{-1} + 2t^{-2} - 2t^{-3} + t^{-4} - t^{-5}). \end{aligned}$$

Thus



$$V\left(\frac{11}{14}\right) = t^3 \overline{V\left(\frac{3}{14}\right)}, \quad V\left(\frac{5}{14}\right) = t^{-3} V\left(\frac{3}{14}\right), \quad V\left(\frac{9}{14}\right) = \overline{V\left(\frac{3}{14}\right)},$$

and

$$V\left(\Gamma_{\frac{3}{14}}\right) \equiv V\left(\frac{3}{14}\right) \equiv t^3 \overline{V\left(\frac{3}{14}\right)} \equiv t^{-3} V\left(\frac{3}{14}\right) \equiv \overline{V\left(\frac{3}{14}\right)}.$$

Via the CCFs of zigzag type, we can recognize the following phenomena on the Jones polynomials for rational links.

REMARK 4.10. It is known that there are four pairs of rational knots with less than or equal to 12 crossings such that their Jones polynomials are the same up to replacing  $t$  with  $t^{-1}$ . The pairs are given as follows.

- (1)  $\{D(T(\frac{29}{49})), D(T(\frac{36}{49}))\}$ ,
- (2)  $\{D(T(\frac{19}{81})), D(T(\frac{37}{81}))\}$ ,
- (3)  $\{D(T(\frac{32}{121})), D(T(\frac{43}{121}))\}$ ,
- (4)  $\{D(T(\frac{64}{147})), D(T(\frac{104}{147}))\}$ .

Viewing the corresponding CCFs, we notice that any pair  $\{D(T(\alpha)), D(T(\beta))\}$  of them has a common characteristic such as  $n(\alpha) - n(ir(\alpha)) = n(r(\alpha)) - n(i(\alpha)) = n(\beta) - n(ir(\beta)) = n(r(\beta)) - n(i(\beta)) = \pm 2$ , and  $n(\alpha) - n(r(\alpha)), n(\beta) - n(r(\beta))$  can be divided by any prime factor of  $d(\alpha) = d(\beta)$ , where  $n(\alpha)$  and  $d(\alpha)$  stand for the numerator and the denominator of  $\alpha$ .

29	22	36	15	19	64	37	46
	49		49		81		81
27	20	34	13	17	62	35	44
32	87	43	76	64	85	106	43
	121		121		147		147
34	89	45	78	62	83	104	41

Further development will be appeared in a forthcoming paper.

### 5. A recurrence formula of the writhe of a rational link diagram in terms of continued fractions

Let us consider a rational number  $\alpha$  in  $(0, 1)$ , and its Yamada’s ancestor triangle  $YAT(\alpha)$  (see [8, 15] for the precise definition and details). We write  $\alpha$  in the continued fraction form  $\alpha = [0, a_1, \dots, a_n]$ . Then, there is a unique downward path in  $YAT(\alpha)$ , which is started from 0 to  $\alpha$ , and is passing through the vertices

$$[0], [0, a_1], [0, a_1, a_2], \dots, [0, a_1, a_2, \dots, a_n].$$

We call the path the *continued fraction path* associated with  $\alpha$ . By the continued fraction path  $YAT(\alpha)$  is divided into  $n$  triangles, which are named as  $\Delta_1, \dots, \Delta_n$  from the top. We note that if  $j$  is odd, then the vertex corresponding to  $[0, a_1, \dots, a_j]$  is on the right oblique line, and otherwise it is on the left.

EXAMPLE 5.1. For  $\alpha = \frac{3}{8} = [0, 2, 1, 2]$ ,  $[0] = \frac{0}{1}$ ,  $[0, 2] = \frac{1}{2}$ ,  $[0, 2, 1] = \frac{1}{3}$ .

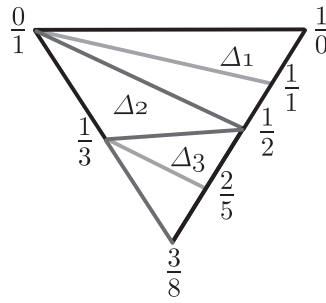

Fig.4. the continued fraction path of  $\frac{3}{8}$

Thus, the continued fraction path of  $\frac{3}{8}$  is the path  $\frac{0}{1} \rightarrow \frac{1}{2} \rightarrow \frac{1}{3} \rightarrow \frac{3}{8}$ . See Figure 4.

**Theorem 5.2.** For each  $j \in \{1, \dots, n\}$  let  $t_\alpha(\Delta_j)$  be the sign of  $\Delta_j$  defined in Remark 4.4, and set  $\alpha_j = [0, a_1, \dots, a_j]$ .

In the case where  $n = 2$ ,

$$t_\alpha(\Delta_2) = (-1)^{a_1}, \quad t_\alpha(\Delta_1) = (-1)^{a_1 a_2 + a_2 + 1}.$$

In the case where  $n \geq 3$ ,

(1) if  $\alpha_{n-2}$  is  $\frac{1}{1}$ -type and  $\alpha_{n-1}$  is  $\frac{1}{0}$ -type, then

$$t_\alpha(\Delta_j) = \begin{cases} (-1)^{d(\alpha_j)(a_n-1)} t_{\alpha_{n-1}}(\Delta_j) & (j = 1, 2, \dots, n-1), \\ t_{\alpha_{n-1}}(\Delta_{n-1}) & (j = n). \end{cases}$$

(2) if  $\alpha_{n-2}$  is  $\frac{0}{1}$ -type and  $\alpha_{n-1}$  is  $\frac{1}{0}$ -type, then

$$t_\alpha(\Delta_j) = \begin{cases} (-1)^{d(\alpha_j)a_n} t_{\alpha_{n-1}}(\Delta_j) & (j = 1, 2, \dots, n-1), \\ -t_{\alpha_{n-1}}(\Delta_{n-1}) & (j = n). \end{cases}$$

(3) if  $\alpha_{n-2}$  is  $\frac{1}{0}$ -type and  $\alpha_{n-1}$  is  $\frac{0}{1}$ -type, then

• if  $a_n$  is even, then

$$t_\alpha(\Delta_j) = \begin{cases} t_{\alpha_{n-1}}(\Delta_j) & (j = 1, 2, \dots, n-1), \\ -t_{\alpha_{n-1}}(\Delta_{n-1}) & (j = n). \end{cases}$$

• if  $a_n$  is odd, then

$$t_\alpha(\Delta_j) = \begin{cases} (-1)^{d(\alpha_j)} t_{\alpha_{n-2}}(\Delta_j) & (j = 1, 2, \dots, n-2), \\ (-1)^{a_{n-1}-1} t_{\alpha_{n-2}}(\Delta_{n-2}) & (j = n-1, n). \end{cases}$$

(4) if  $\alpha_{n-2}$  is  $\frac{1}{1}$ -type and  $\alpha_{n-1}$  is  $\frac{0}{1}$ -type, then

• if  $a_n$  is even, then

$$t_\alpha(\Delta_j) = \begin{cases} t_{\alpha_{n-2}}(\Delta_j) & (j = 1, 2, \dots, n-2), \\ (-1)^{a_{n-1}} t_{\alpha_{n-2}}(\Delta_{l-2}) & (j = n-1, n). \end{cases}$$

• if  $a_n$  is odd, then

$$t_\alpha(\Delta_j) = \begin{cases} t_{\alpha_{n-1}}(\Delta_j) & (j = 1, 2, \dots, n-1), \\ t_{\alpha_{n-1}}(\Delta_{n-1}) & (j = n). \end{cases}$$

(5) if  $\alpha_{n-2}$  is  $\frac{0}{1}$ -type and  $\alpha_{n-1}$  is  $\frac{1}{1}$ -type, then

$$t_\alpha(\Delta_j) = \begin{cases} t_{\alpha_{n-2}}(\Delta_j) & (j = 1, 2, \dots, n-2), \\ (-1)^{a_{n-1}} t_{\alpha_{n-2}}(\Delta_{l-2}) & (j = n-1, n). \end{cases}$$

(6) if  $\alpha_{n-2}$  is  $\frac{1}{0}$ -type and  $\alpha_{n-1}$  is  $\frac{1}{1}$ -type, then

$$t_\alpha(\Delta_j) = \begin{cases} t_{\alpha_{n-2}}(\Delta_j) & (j = 1, 2, \dots, n-2), \\ (-1)^{a_{n-1}} t_{\alpha_{n-2}}(\Delta_{n-2}) & (j = n-1, n). \end{cases}$$

Here,  $d(\alpha_j) \in \{0, 1\}$  is the denominator of the type of  $\alpha_j$ .

To prove the theorem let us recall the definition of a Seifert path, which is introduced by Nagai and Terashima [13]. Let  $\alpha$  be a rational number in  $(0, 1)$ . Every vertex in the Yamada’s ancestor triangle  $YAT(\alpha)$  is one of the  $\frac{1}{1}$ ,  $\frac{1}{0}$ ,  $\frac{0}{1}$ -types. A *Seifert path* of  $\alpha$  is a downward path in  $YAT(\alpha)$ , which is started from  $\frac{0}{1}$  to  $\alpha$  satisfying the following condition: The end points of any edge in the path consist of  $\frac{1}{1}$ - and  $\frac{1}{0}$ -types, or consist of  $\frac{1}{0}$ - and  $\frac{0}{1}$ -types. If the denominator of  $\alpha$  is odd, then a Seifert path is uniquely determined. We denote the Seifert path by  $\gamma_\alpha$ . If the denominator of  $\alpha$  is even, namely  $\alpha$  is of type  $\frac{1}{0}$ , then there are exactly two Seifert paths. In this case we denote by  $\gamma_\alpha$  the Seifert path whose vertices consist of  $\frac{1}{0}$ - and  $\frac{0}{1}$ -types, and denote by  $\gamma'_\alpha$  the remaining Seifert path. As a similar to  $t_\alpha(\Delta_j)$ , we define a sign  $t'_\alpha(\Delta_j)$  by the following inductive rules.

- at first, set  $t'_\alpha(\Delta_1) := -1$ , and
- after  $t'_\alpha(\Delta_j)$  is defined, set

$$t'_\alpha(\Delta_{j+1}) := \begin{cases} t'_\alpha(\Delta_j) & \text{if there is no edge in } \gamma'_\alpha \text{ between } \Delta_j \text{ and } \Delta_{j+1}, \\ -t'_\alpha(\Delta_j) & \text{otherwise.} \end{cases}$$

We remark that  $t'_\alpha(\Delta_j) = \epsilon_j t_\alpha(\Delta_j)$  holds for  $j = 1, 2, \dots, n$ , where

$$\epsilon_1 = 1, \quad \epsilon_j = \begin{cases} 1 & \text{if the denominator of } \alpha_{j-1} \text{ is odd,} \\ -1 & \text{otherwise.} \end{cases}$$

Proof of Theorem 5.2. It can be easily verified in the case where  $n = 2$ . So, we consider the case where  $n \geq 3$ . In this case, the statement can be shown by case-by-case argument. We only demonstrate the proof of Part (1) since other cases are verified by a quite similar argument.

Consider the case where  $a_n$  is even. Then the Seifert path  $\gamma_\alpha$  is obtained by connecting  $\gamma'_{\alpha_{n-1}}$  with the edges between  $\alpha_{n-1}$  and  $\alpha$ .

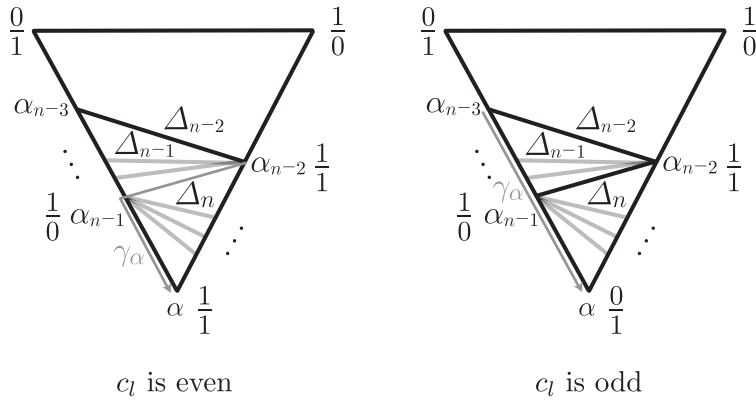

Since there is an edge in  $\gamma_\alpha$  between  $\Delta_{n-1}$  and  $\Delta_n$ , we have  $t_\alpha(\Delta_n) = -t_\alpha(\Delta_{n-1})$ . Moreover, for all  $j = 1, 2, \dots, n - 2$ , we see that

$$t_\alpha(\Delta_j) = -t_\alpha(\Delta_{j+1}) \iff t'_{\alpha_{n-1}}(\Delta_j) = -t'_{\alpha_{n-1}}(\Delta_{j+1}).$$

Since  $\alpha$  is  $\frac{1}{1}$ -type whereas  $\alpha_{n-1}$  is  $\frac{1}{0}$ -type,  $t_\alpha(\Delta_1) = 1$  and  $t'_{\alpha_{n-1}}(\Delta_1) = -1$ . Thus,

$$t_\alpha(\Delta_j) = -t'_{\alpha_{n-1}}(\Delta_j) = -\epsilon_j t_{\alpha_{n-1}}(\Delta_j)$$

for all  $j = 1, 2, \dots, n - 1$ . Since  $\alpha_{n-2}$  is  $\frac{1}{1}$ -type, we have  $t_\alpha(\Delta_{n-1}) = -t_{\alpha_{n-1}}(\Delta_{n-1})$ , and hence  $t_\alpha(\Delta_n) = -t_\alpha(\Delta_{n-1}) = t_{\alpha_{n-1}}(\Delta_{n-1})$ . It follows that

$$t_\alpha(\Delta_j) = \begin{cases} -\epsilon_j t_{\alpha_{n-1}}(\Delta_j) & (j = 1, 2, \dots, n - 1), \\ t_{\alpha_{n-1}}(\Delta_{n-1}) & (j = n). \end{cases}$$

Consider the case where  $a_n$  is odd. Then  $\gamma_\alpha$  is obtained by connecting  $\gamma_{\alpha_{n-1}}$  with the edges between  $\alpha_{n-1}$  and  $\alpha$ . In this case, since there is no edge in  $\gamma_\alpha$  between  $\Delta_{n-1}$  and  $\Delta_n$ , we have  $t_\alpha(\Delta_n) = t_\alpha(\Delta_{n-1})$ . Since  $\alpha$  is  $\frac{0}{1}$ -type and  $\alpha_{n-1}$  is  $\frac{1}{0}$ -type, it follows that  $t_\alpha(\Delta_1) = -1 = t_{\alpha_{n-1}}(\Delta_1)$ . So, by the same argument above, we see that

$$t_\alpha(\Delta_j) = t_{\alpha_{n-1}}(\Delta_j)$$

for all  $j = 1, 2, \dots, n - 1$ . In particular,  $t_\alpha(\Delta_{n-1}) = t_{\alpha_{n-1}}(\Delta_{n-1})$ . Thus  $t_\alpha(\Delta_n) = t_\alpha(\Delta_{n-1}) = t_{\alpha_{n-1}}(\Delta_{n-1})$ , and therefore,

$$t_\alpha(\Delta_j) = \begin{cases} t_{\alpha_{n-1}}(\Delta_j) & (j = 1, 2, \dots, n - 1), \\ t_{\alpha_{n-1}}(\Delta_{n-1}) & (j = n). \end{cases}$$

□

By induction argument we have the following corollary from Theorem 5.2.

**Corollary 5.3.** *Under the same notation with Theorem 5.2, the sign  $t_\alpha(\Delta_n)$  of the top triangle  $\Delta_n$  is given by the formula:*

$$t_\alpha(\Delta_n) = (-1)^{(d(\alpha_n)+1)n(\alpha_{n-1})+d(\alpha_n)n(\alpha_{n-1})+n},$$

where,  $d(\alpha_j), n(\alpha_j) \in \{0, 1\}$  are the denominator and the numerator of the type of  $\alpha_j$ , respectively.

EXAMPLE 5.4. (1) Consider the case where  $\alpha = \frac{3}{8} = [0, 2, 1, 2]$ . We set

$$\alpha_1 := [0, 2] = \frac{1}{2}, \quad \alpha_2 := [0, 2, 1] = \frac{1}{3}, \quad \alpha_3 := [0, 2, 1, 2] = \frac{3}{8},$$

and let  $\{\Delta_1, \Delta_2, \Delta_3\}$  be the corresponding triangle sequence for  $\alpha$ . Since  $\alpha_1$  is  $\frac{1}{0}$ -type and  $\alpha_2$  is  $\frac{1}{1}$ -type, it follows from Theorem 5.2(6) that

$$\begin{aligned} t_\alpha(\Delta_3) &= t_\alpha(\Delta_2) = (-1)^{2-1}t_{\alpha_1}(\Delta_1) = -t_{\alpha_1}(\Delta_1), \\ t_\alpha(\Delta_1) &= t_{\alpha_1}(\Delta_1). \end{aligned}$$

By Theorem 5.2 again, we have  $t_{\alpha_1}(\Delta_1) = (-1)^{2+1} = -1$ , and therefore

$$t_\alpha(\Delta_3) = t_\alpha(\Delta_2) = 1, \quad t_\alpha(\Delta_1) = -1.$$

By using the formula (4.14) we see that the writhe of the oriented diagram  $D(T(\frac{3}{8}))$  is given by  $\text{wr}(\frac{3}{8}) = -((-1) \cdot 2 + 1 \cdot 1 + 1 \cdot 2) = -1$ .

(2) Consider the case where  $\alpha = \frac{8}{11} = [0, 1, 2, 1, 2]$ . We set

$$\alpha_1 := [0, 1] = \frac{1}{1}, \quad \alpha_2 := [0, 1, 2] = \frac{2}{3}, \quad \alpha_3 := [0, 1, 2, 1] = \frac{3}{4}, \quad \alpha_4 := [0, 1, 2, 1, 2] = \frac{8}{11},$$

and let  $\{\Delta_1, \Delta_2, \Delta_3, \Delta_4\}$  be the corresponding triangle sequence for  $\alpha$ . Since  $\alpha_2$  is  $\frac{0}{1}$ -type and  $\alpha_3$  is  $\frac{1}{0}$ -type, it follows from Theorem 5.2(2) that

$$\begin{aligned} t_\alpha(\Delta_4) &= -t_{\alpha_3}(\Delta_3), \\ t_\alpha(\Delta_j) &= (-\epsilon_j)^2 t_{\alpha_3}(\Delta_j) = t_{\alpha_3}(\Delta_j) \end{aligned}$$

for  $j = 1, 2, 3$ . In addition,  $\alpha_1$  is  $\frac{1}{1}$ -type and  $c_3 = 1$  is odd. Thus, applying Theorem 5.2(4) we have

$$\begin{aligned} t_{\alpha_3}(\Delta_3) &= t_{\alpha_2}(\Delta_2), \\ t_{\alpha_3}(\Delta_j) &= t_{\alpha_2}(\Delta_j) \end{aligned}$$

for  $j = 1, 2$ . Since  $t_{\alpha_2}(\Delta_2) = (-1)^1 = -1$ ,  $t_{\alpha_2}(\Delta_1) = (-1)^{2+3} = -1$ , we see that

$$\begin{aligned} t_\alpha(\Delta_4) &= -t_{\alpha_3}(\Delta_3) = -t_{\alpha_2}(\Delta_2) = 1, \\ t_\alpha(\Delta_3) &= t_{\alpha_3}(\Delta_3) = t_{\alpha_2}(\Delta_2) = -1, \\ t_\alpha(\Delta_2) &= t_{\alpha_3}(\Delta_2) = t_{\alpha_2}(\Delta_2) = -1, \\ t_\alpha(\Delta_1) &= t_{\alpha_3}(\Delta_1) = t_{\alpha_2}(\Delta_1) = -1. \end{aligned}$$

By using the formula (4.14) we see that the writhe of the oriented diagram  $D(T(\frac{8}{11}))$  is given by  $\text{wr}(\frac{8}{11}) = 2$ .

ACKNOWLEDGEMENTS. We would like to thank Professors Mikami Hirasawa, Makoto Sakuma, Yuji Terashima for many helpful comments. The work of the first author is partially supported by Grant-in-Aid for Scientific Research (C) No.17K05209 from Japan Society for the Promotion of Science.

---

### References

- [1] J.H. Conway: *An enumeration of knots and links, and some of their algebraic properties*; in Computational problems in abstract algebra 1967, Pergamon Press, Oxford, 1970, 329–335.
- [2] J.H. Conway and H.S.M. Coxeter: *Triangulated polygons and frieze patterns*, Math. Gaz. **57** (1973), 87–94.
- [3] J.H. Conway and H.S.M. Coxeter: *Triangulated polygons and frieze patterns II*, Math. Gaz. **57** (1973), 175–183.
- [4] H.S.M. Coxeter: *Frieze patterns*, Acta Arith. **18** (1971), 297–310.
- [5] P. Cromwell: *Knots and links*, Cambridge University Press, Cambridge, 2004.
- [6] A. Hatcher and U. Ortel: *Boundary slopes for Montesinos knots*, Topology **28** (1989), 453–480.
- [7] L.H. Kauffman: *State models and the Jones polynomial*, Topology **26** (1987), 395–407.
- [8] T. Kogiso and M. Wakui: *A bridge between Conway-Coxeter Friezes and rational tangles through the Kauffman bracket polynomials*, J. Knot Theory Ramifications **28** (2019), 1950083, 40pp.
- [9] K. Lee and R. Schiffler: *Cluster algebras and Jones polynomials*, Selecta Math. (N.S.) **25** (2019), Paper No.58, 41pp.
- [10] S. Morier-Genoud: *Coxeter’s frieze patterns at the crossroads of algebra, geometry and combinatorics*, Bull. London Math. Soc. **47** (2015), 895–938.
- [11] S. Morier-Genoud and V. Ovsienko: *q-deformed rationals and q-continued fractions*, Forum Math. Sigma **8** (2020), e13, 55pp.
- [12] K. Murasugi: *Knot theory and its applications*, translated from the 1993 Japanese original by Bohdan Kurpita, Birkhäuser, Boston, MA, 1996.
- [13] W. Nagai and Y. Terashima: *Cluster variables, ancestral triangles and Alexander polynomials*, Adv. Math. **363** (2020), 106965, 37pp.
- [14] H. Schubert: *Knoten mit zwei Brücken*, Math. Zeit. **65** (1956), 133–170.
- [15] S. Yamada: *Jones polynomial of two-bridge knots (Ni-hashi musubime no Jones takoushiki)*, in Japanese, in Proceedings of “Musubime no shomondai to saikin no seika”, 1996, 92–96.

Takeyoshi Kogiso  
 Department of Mathematics  
 Josai University  
 1–1, Keyakidai Sakado, Saitama, 350–0295  
 Japan  
 e-mail: kogiso@josai.ac.jp

Michihisa Wakui  
 Department of Mathematics, Faculty of Engineering Science  
 Kansai University  
 Suita-shi, Osaka 564–8680  
 Japan  
 e-mail: wakui@kansai-u.ac.jp