

The iteration of cubic polynomials

Part I: The global topology of parameter space

by

BODIL BRANNER and JOHN H. HUBBARD

*The Technical University of Denmark
and
Cornell University, Ithaca, NY, U.S.A.*

*Cornell University,
Ithaca, NY, U.S.A.*

Table of contents

Introduction.	143
CHAPTER I. Univalent functions in complex analytic dynamics.	147
1. Attraction to infinity.	147
2. Parametrizing the space of polynomials.	150
3. Compactness of the connectedness locus.	153
4. The mapping φ_p is close to the identity.	156
5. The high level sets of H are spheres.	160
CHAPTER II. Wringing the complex structure.	165
6. Beltrami forms invariant under a polynomial.	166
7. Analytic dependence on parameters.	169
8. Stretching and wringing the complex structure.	171
9. Continuity on the structural stability set.	177
10. Continuity for cubic polynomials.	179
CHAPTER III. The global topology of parameter space.	183
11. Fibrations.	184
12. The structure of the fiber, part 1.	185
13. The structure of the fiber, part 2.	193
14. The global topology of parameter space.	197
References.	205

Introduction

This series of papers is concerned with the way in which the space of polynomials of degree $d > 2$ is decomposed when the polynomials are classified according to their dynamic behavior under iteration. Our results are satisfying only for $d=3$.

According to Fatou and Julia, and the more recent work of Mañé, Sad, Sullivan, the main question to ask about a rational map is: *what are the orbits under iteration of*

the critical points? Therefore a coarse decomposition of the space of polynomials of degree d can be obtained by separating those with different numbers of critical points attracted to the superattractive fixed point infinity.

More precisely, if P is a monic polynomial of degree d , we will show that the function

$$h_P(z) = \lim d^{-n} \log_+ |P^{\circ n}(z)|$$

exists and is continuous on \mathbb{C} , vanishing identically on

$$K_P = \{z \mid P^{\circ n}(z) \text{ does not tend to } \infty\}.$$

The function h_P measures the rate at which z escapes to ∞ . In fact, h_P is the Green's function of K_P .

Let $H(P) = \sup \{h_P(\omega) \mid \omega \text{ a critical point of } P\}$.

The *first decomposition* is to separate the *connectedness locus* from the rest, where the connectedness locus

$$\mathcal{C}_d = \{P \mid H(P) = 0\}$$

consist of those polynomials of degree d for which none of the finite critical points are attracted to infinity. Equivalently

$$\mathcal{C}_d = \{P \mid K_P \text{ is connected}\},$$

whence the name.

Call a polynomial *centered* if the average of its roots is zero. We will show that in any degree $d \geq 2$, the set of centered monic polynomials P with K_P connected is compact. The third paper in this series will deal with the fine structure of the connectedness locus for cubic polynomials.

Outside the connectedness locus the decomposition can be refined. Let

$$\mathcal{S}_r = \{P \mid P \text{ is monic, centered and } H(P) = \log r\}$$

for $r > 1$.

CONJECTURE. *The space \mathcal{S}_r is homeomorphic to a sphere of dimension $2d-3$ for any $d \geq 2$. In particular, the connectedness locus is cell-like in any degree.*

In this paper we will prove that \mathcal{S}_r is homeomorphic to a sphere of dimension $2d-3$

for any $d \geq 2$ if $\log r$ is sufficiently large (Theorem 5.6), but we are able to prove the conjecture only for d equal to 2 and 3 (Theorem 11.1 and Corollary 11.2).

One of the two principal conjectures for the Mandelbrot set $M = \mathcal{C}_2$ is that the set is locally connected. Recently J. Minor [M] has observed that the connectedness locus \mathcal{C}_3 is not locally connected.

In order to describe further refinements of the parameter space for cubic polynomials, we need to introduce a specific parametrization. If we write our cubic polynomials

$$P(z) = z^3 - 3a^2z + b$$

so that the critical points are $\pm a$, we can divide \mathcal{S}_r into \mathcal{S}_r^+ and \mathcal{S}_r^- according to whether the critical point which escapes fastest is $+a$ or $-a$, providing the *second decomposition*.

THEOREM. *The interiors of \mathcal{S}_r^\pm are solid tori unknotted in \mathcal{S}_r and linked with linking number 3.*

This result, stated more precisely as Theorem 13.1, together with the proof of the conjecture for $d=3$, are the main results of his paper.

This decomposition can be refined further; any polynomial P of degree d can be analytically conjugated to $z \mapsto z^d$ in a neighborhood of infinity. There is a canonical choice for the conjugating map φ_P and therefore a canonical choice of polar coordinates in the neighborhood of infinity. If the polynomial is outside the connectedness locus the neighborhood can always be chosen to contain the image of the fastest escaping critical point, i.e. the function

$$\psi^\pm(P) = \varphi_P(P(\pm a))$$

is well-defined on \mathcal{S}_r^\pm .

The *third decomposition* therefore is to separate polynomials according to not only the escape rate but also the angle for the fastest escaping critical point. For cubic polynomials the set

$$\mathcal{Y}_r^\pm(\alpha) = \{P \in \mathcal{S}_r^\pm \mid \psi^\pm(P) = r^3 e^{2\pi i \alpha}\}$$

is three closed discs with one boundary point in common, i.e. a trefoil clover leaf (Corollary 13.3).

The *fourth decomposition* for cubic polynomials will be obtained by dividing up each clover leaf according to how the other critical point is attracted to infinity, if it is. The decomposition can be described completely combinatorially. Each leaf contains infinitely many copies of the Mandelbrot set for quadratic polynomials. The combinatorics involved is quite complicated, and the theory of polynomial-like mappings [D-H3] is essential. This will be the content of the second paper in this series.

This paper is divided into three chapters.

In the first chapter, *Univalent functions in complex analytic dynamics*, we analyze the main tools for understanding iteration of a polynomial P : the maps h_P and φ_P mentioned above. In order to estimate how much the univalent function φ_P differs from the identity we use a generalization of the Area theorem and the Koebe $\frac{1}{4}$ -theorem. From these estimates we can prove that the connectedness locus is compact and that the set of polynomials outside the connectedness locus with a fixed escape rate to infinity for the fastest escaping critical point is homeomorphic to a sphere for sufficiently large escape rate.

In the second chapter, *Wringing the complex structure*, we stretch and turn (i.e. wring) the complex structure, in such a way that it is invariant under a given polynomial P . By using the measurable Riemann mapping theorem each P -invariant wring gives rise to a new polynomial. *Only for cubic polynomials we are able to show that the new polynomials depend continuously on the original polynomials and the wring.* The proof of continuity outside the set of structural stability for cubic polynomials comes in Section 10. It is hard and the main technical result of the paper. Until Section 10 everything is true for polynomials in general.

In the third chapter, *The global topology of parameter space*, we restrict ourselves to cubic polynomials. By using the stretching of the complex structure we can show that the map measuring the fastest escape rate outside the connectedness locus is a fibration with fibers homeomorphic to S^3 . By using the wringing of the complex structure we can show that the map measuring the fastest escape rate and the angle is a fibration. The hard work is done in Chapter 2. It is not so easy to show that the fibers for the last fibration are homeomorphic to a clover leaf. This is the content of Sections 12 and 13, and requires some tools from algebraic topology, including the classification of surfaces and a theorem of Alexander's about embeddings of the torus in S^3 . In Section 14 the global topological structure of each sphere is described.

In the beginning of each chapter there is a short introduction to that chapter.

For a general reference on complex analytic dynamics, see [BI] and [D-H2]. This paper fits into the investigation developed in [D-H2], but the main result uses quasi-

conformal mappings, in the way pioneered by Sullivan [S]; many of the ideas are inspired by his vision.

We thank P. Blanchard, W. Thurston and especially A. Douady for many helpful conversations, the Mittag-Leffler Institute and the Department of Mathematics at Cornell for hospitality and N.S.F. grant DMS 83-01564 for support during the research that went into this paper.

Chapter I. Univalent functions and complex dynamical systems

Introduction

The key to understanding iteration of polynomials in the complex domain is the existence of an analytic map conjugating the polynomial to $z \mapsto z^d$ in a neighborhood of infinity. This map is unique up to multiplication by a $(d-1)$ th root of 1; so it gives a “dynamically defined” coordinate system near infinity. If a critical point is attracted to infinity, some forward image is in the domain of this local coordinate, providing “dynamically defined” analytic functions on the parameter space.

In this chapter we will apply this idea. Moreover, the behaviour of the critical points determines the region in which the conjugating mapping above is univalent. There are a wealth of results on univalent functions, and a small modification of the area theorem will give us inequalities which will relate the positions in the “dynamic” local coordinate to the actual positions in \mathbb{C} .

Section 1. Attraction to infinity

For any polynomial P of degree $d > 1$, the point at infinity is attractive, in fact super-attractive. But it is classical (see [Bl]) that any time z_0 is a fixed point of an analytic mapping f with

$$f(z_0 + u) = z_0 + a_d u^d + \dots$$

there is a coordinate system ζ near z_0 in which f is written ζ^d ; furthermore this coordinate system is very rigid: it is unique up to multiplication by a $(d-1)$ -root of 1. (The coordinate ζ is sometimes referred to as a Boettcher coordinate.) Using this coordinate system, we can try to “locate points with respect to ∞ ”, if they are attracted to infinity. This location has been a key tool in iteration of polynomials.

More precisely, let \mathcal{P}_d be the set of monic polynomials of degree $d > 1$, with no term of degree $d-1$. Note that each polynomial of degree d is affine conjugate to an element

of \mathcal{P}_d , and that the only affine maps conjugating an element of \mathcal{P}_d to another are the multiplications by $(d-1)$ th roots of 1.

For any $P \in \mathcal{P}_d$, define the real valued function h_P on \mathbf{C} by

$$h_P(z) = \lim_{n \rightarrow \infty} d^{-n} \log_+ |P^n(z)|,$$

where \log_+ is the supremum of \log and 0.

PROPOSITION 1.1. (1) h_P is defined and continuous on all of \mathbf{C} ,

(2) $h_P(P(z)) = dh_P(z)$,

(3) The set K_P is precisely the set of z with $h_P(z) = 0$, and h_P is harmonic on $\mathbf{C} - K_P$,

(4) The critical points of h_P in $\mathbf{C} - K_P$ are the inverse images of the critical points of P by $P^{\circ n}$.

Proof. All of this is proved in [D-H2, VIII]. However, we will need a strengthening of (1), and will reprove (1) in the process. \square

PROPOSITION 1.2. The mapping $h_P(z)$ is continuous as a function of both z and P .

Proof. The function $h_P(z)$ is defined by the formula

$$h_P(z) = \lim_{n \rightarrow \infty} d^{-n} \log_+ |P^{\circ n}(z)|;$$

we will show that the sequence converges uniformly on compact subsets.

Make the sequence into a series in the obvious way:

$$h_P(z) = \log_+(z) + \sum (d^{-(n+1)} \log_+ |P^{\circ(n+1)}(z)| - d^{-n} \log_+ |P^{\circ n}(z)|).$$

Write the polynomial $P(z) = z^d + c_{d-2}z^{d-2} + \dots + c_0$, then

$$\frac{P(z)}{z^d} = 1 + \frac{c_{d-2}}{z^2} + \dots + \frac{c_0}{z^d},$$

and thus

$$|\log_+ |P(z)| - d \log_+ |z|| \leq C(P)$$

where $C(P)$ depends continuously on P and is independent of z . Now

$$h_p(z) = \log_+(z) + \sum d^{-(n+1)} (\log_+ |P(z_n)| - d \log_+ |(z_n)|)$$

where $z_n = P^{\circ n}(z)$. The general term of the series depends continuously on P and z , and the series converge uniformly when P ranges in a compact set. \square

Let Ω_p be the set of critical points of P in \mathbb{C} , and define

$$H(P) = \sup_{\omega \in \Omega_p} h_p(\omega).$$

COROLLARY 1.3. *The function $H: \mathcal{P}_d \rightarrow \mathbb{R}$ is continuous.*

Further define $U_p = \{z \mid h_p(z) > H(P)\}$. Since h has no critical points in U_p , the level curves of h_p are real-analytic simple closed curves in U_p . Note that if $H(P)=0$, then $U_p = \mathbb{C} - K_p$; this is why K_p is connected in that case.

The level curves of h_p and their orthogonal curves form something like a system of polar coordinates on U_p . Define r_p by

$$\log r_p = H(P).$$

PROPOSITION 1.4. *There exists a unique analytic isomorphism*

$$\varphi_p: U_p \rightarrow \mathbb{C} - \bar{D}_{r_p}$$

such that

(1) *the diagram*

$$\begin{array}{ccc} U_p & \xrightarrow{P} & U_p \\ \varphi_p \downarrow & & \downarrow \varphi_p \\ \mathbb{C} - \bar{D}_{r_p} & \xrightarrow{P_0} & \mathbb{C} - \bar{D}_{r_p} \end{array}$$

commutes, where $P_0(z) = z^d$;

(2) φ_p is tangent to the identity at infinity.

The other maps φ_k satisfying (1) are precisely $e^{2\pi i k/(d-1)} \varphi_p$.

Proof. These results are proved in [D-H2]. However, we need the following construction from the proof. The mapping φ_p can be defined in a neighborhood of ∞ by the infinite product

$$\varphi_P(z) = z \prod \left(1 + \frac{Q(P^{\circ n}(z))}{(P^{\circ n}(z))^d} \right)^{d^{-(n+1)}}, \quad (1)$$

in analogy to the series defining h_P , where $Q(z) = P(z) - z^d$. In Section 5 we will show by induction that $|P^{\circ n}(z)|$ is increasing with n under appropriate circumstances, so that

$$\frac{|Q(P^{\circ n}(z))|}{|(P^{\circ n}(z))^d|} < \frac{1}{4} \quad (2)$$

holds for all n and the principal branch of the $d^{(n+1)}$ -root is well defined.

Remarks. (a) Note that φ_P is defined on all $\mathbb{C} - K_P$ if all critical points of P are in K_P , giving a uniformization of $\tilde{\mathbb{C}} - K_P$.

(b) In U_P , we have that $h_P = \log |\varphi_P|$.

(c) φ_P can be extended analytically to $\mathbb{C} - (K_P \cup G_P)$, where G_P is the union of the singular points of the vector-field $\text{grad}(h_P)$ and their stable manifolds.

These mappings h_P and φ_P are the main tools of the entire paper.

Section 2. Parametrizing the space of polynomials

We shall now discuss the parametrization to be used.

First note that for an arbitrary polynomial Q of degree n

$$Q(z) = q_n z^n + q_{n-1} z^{n-1} + \dots + q_0$$

the roots z_1, z_2, \dots, z_n are centered at 0 i.e. $\sum z_i = 0$ if and only if $q_{n-1} = 0$.

As a consequence, for a monic polynomial, the following three properties are equivalent:

- (1) $P \in \mathcal{P}_d$
- (2) the critical points are centered at 0 (set $Q = P'$)
- (3) the preimages of any w are centered at 0 (set $Q = P - w$).

A polynomial which satisfies (1), (2), (3) will be called *centered*.

Let $\mathbf{H} = \mathbf{H}^{d-2}$ denote the following hyperplane in \mathbb{C}^{d-1}

$$\mathbf{H} = \left\{ \mathbf{a} = (a_1, a_2, \dots, a_{d-1}) \in \mathbb{C}^{d-1} \mid \sum a_i = 0 \right\}.$$

To each $(\mathbf{a}, b) \in \mathbf{H} \times \mathbf{C}$ let $P_{\mathbf{a}, b} \in \mathcal{P}_d$ denote the polynomial with critical points a_1, a_2, \dots, a_{d-1} and $P(0) = b$.

The coefficients for $P_{\mathbf{a}, b}$ can be expressed in terms of the elementary symmetric polynomials in $(a_1, a_2, \dots, a_{d-1})$, where the j th elementary symmetric polynomial is

$$\sigma_j(\mathbf{a}) = \sum_{1 \leq i_1 < \dots < i_j \leq d-1} a_{i_1} \dots a_{i_j}.$$

Since

$$\begin{aligned} P'_{\mathbf{a}, b}(z) &= d(z-a_1)(z-a_2) \dots (z-a_{d-1}) \\ &= d[z^{d-1} + (-1)\sigma_1(\mathbf{a})z^{d-2} + (-1)^2\sigma_2(\mathbf{a})z^{d-3} + \dots + (-1)^{d-1}\sigma_{d-1}(\mathbf{a})], \end{aligned}$$

we have

$$P_{\mathbf{a}, b}(z) = z^d + (-1)^2 \frac{d}{d-2} \sigma_2(\mathbf{a}) z^{d-2} + \dots + (-1)^{d-1} d \sigma_{d-1}(\mathbf{a}) z + b.$$

It is clear that $P_{\mathbf{a}, b} = P_{\tilde{\mathbf{a}}, \tilde{b}}$ if and only if $\tilde{b} = b$ and $(\tilde{a}_1, \dots, \tilde{a}_{d-1})$ is a permutation of (a_1, \dots, a_{d-1}) .

Note that for $d=2$ the polynomials are

$$P_b(z) = z^2 + b, \quad b \in \mathbf{C}$$

and that for $d=3$ the polynomials are

$$P_{a, b}(z) = z^3 - 3a^2z + b, \quad (a, b) \in \mathbf{C}^2.$$

In the study of degree d polynomials we shall use $\mathbf{H} \times \mathbf{C}$ as parameter space. The map $(\mathbf{a}, b) \mapsto P_{\mathbf{a}, b}$ is a $(d-1)!$ -fold cover of \mathcal{P}_d ramified along the set of polynomials for which there is a critical point of multiplicity greater than 2. For cubic polynomials we shall use \mathbf{C}^2 as parameter space instead of $\mathbf{H} \times \mathbf{C}$ where $\mathbf{a} = (a_1, a_2) = (+a, -a)$.

Suppose the polynomials $P_{\mathbf{a}, b}$ and $P_{\tilde{\mathbf{a}}, \tilde{b}}$ are affine conjugated, then the conjugating map is necessarily of the form $f_\delta: z \mapsto \delta z$, where δ is a $(d-1)$ th root of unity. Therefore $\tilde{b} = \delta b$ and $\tilde{\mathbf{a}}$ equals $\delta \mathbf{a}$ up to permutation.

Let $P = P_{\mathbf{a}, b}$ and let $\varphi = \varphi_{\mathbf{a}, b}$ be the unique φ -map tangent to the identity at ∞ as defined in Proposition 1.4. The φ -map for the polynomial $P_\delta = P_{\delta \mathbf{a}, \delta b}$ is $\varphi_\delta = f_\delta \circ \varphi \circ f_\delta^{-1}$ defined on $f_\delta(U_P)$. Instead of changing from a polynomial P with canonical polar coordinates defined by φ to the polynomial P_δ with canonical polar coordinates defined

by φ_δ we could as well just have kept P and used the polar coordinate system defined by $\delta\varphi$.

Points in $\mathbf{H} \times \mathbf{C}$ then correspond bijectively to a polynomial of degree d provided with a numbering of the critical points and a φ -map, up to conjugacy.

In Section 14 we shall discuss the global topology of the parameter space \mathbf{C}^2 for cubic polynomials and of different quotients thereof.

The parameter space $\mathbf{H} \times \mathbf{C}$ splits up into the *connectedness locus*

$$\mathcal{C}_d = \{(\mathbf{a}, b) \mid H(\mathbf{a}, b) = 0\},$$

where $K_{P_{\mathbf{a}, b}}$ is connected, and the complement $\mathbf{H} \times \mathbf{C} - \mathcal{C}_d$, where $K_{P_{\mathbf{a}, b}}$ is not connected.

For $r > 1$ define

$$\mathcal{S}_r = \{(\mathbf{a}, b) \mid H(\mathbf{a}, b) = \log r\}.$$

Each \mathcal{S}_r can be covered by

$$\mathcal{S}_r^j = \{(\mathbf{a}, b) \mid h_{\mathbf{a}, b}(a_j) = \log r\}, \quad j = 1, \dots, d-1.$$

The linear maps $\mathbf{H} \times \mathbf{C} \rightarrow \mathbf{H} \times \mathbf{C}$ given by permuting $(a_1, a_2, \dots, a_{d-1})$ permute the \mathcal{S}_r^j . Finally each subset \mathcal{S}_r^j splits up into

$$\mathcal{Y}_r^j(\alpha) = \{(\mathbf{a}, b) \in \mathcal{S}_r^j \mid \varphi_{\mathbf{a}, b}(P_{\mathbf{a}, b}(a_j)) = r^\alpha e^{i2\pi\alpha}\}.$$

In every parameter space $\mathbf{H} \times \mathbf{C}$ the subset $\{0\} \times \mathbf{C}$, corresponding to the polynomials $P_{0, b}(z) = z^d + b$, plays an important role. The intersection of $\{0\} \times \mathbf{C}$ with the connectedness locus is called the *Mandelbrot set*

$$M_d = \{b \in \mathbf{C} \mid P_{0, b} \circ^n(z) \rightarrow \infty\}.$$

A description of $\mathbf{C} - M_d$ can be given for any $d \geq 2$, similar to the description of M_2 given in [D-H2].

Let $b \in \mathbf{C} - M_d$ and define $\Phi(b) = \varphi_{0, b}(b)$. As for quadratic polynomials we have the following

THEOREM 2.1. *The map $\Phi: \mathbf{C} - M_d \rightarrow \mathbf{C} - \bar{D}$ is an analytic isomorphism.*

The proof is a copy of the proof in degree $d=2$ [D-H2, VIII]. The proof is an application of the principle: an analytic mapping is an isomorphism if it is proper of

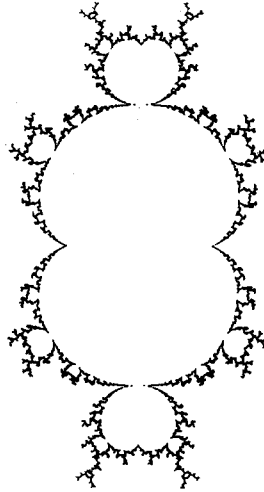

Fig. 2.1

degree 1. We shall use the theorem for cubic polynomials in Section 12, where we also shall use the principle again.

COROLLARY 2.2. *The Mandelbrot set M_d is connected.*

This result has been found independently by several authors, in particular Chaves [C], L. Goldberg [D-G-H].

The set M_3 is shown in Figure 2.1. Figure 5.1 shows M_2 .

The following proposition gives a characterization of the polynomials $P_{a,b}$.

PROPOSITION 2.3. *If all the critical values are equal for a polynomial $P_{a,b}$, then $a=0$.*

Proof. Since $P: \mathbb{C} - P^{-1}(P(\Omega)) \rightarrow \mathbb{C} - P(\Omega)$ is an unramified covering and $P(\Omega)$ is a point, it follows that the covering space $\mathbb{C} - P^{-1}(P(\Omega))$ is a plane minus a point. Therefore $P^{-1}(P(\Omega)) = \{0\}$ and $a=0$. □

Section 3. Compactness of the connectedness locus

We shall prove not only that the connectedness locus \mathcal{C}_d is compact for any $d \geq 2$, but more generally that the set

$$\mathcal{H}_r = \{(a, b) \in \mathbb{H} \times \mathbb{C} \mid H(a, b) \leq \log r\}$$

is compact for all $r \geq 1$. Hence \mathcal{S}_r and \mathcal{S}_r^j are compact sets.

In both this section and the next, estimates from the theory of univalent functions are the main tool. All follow from Proposition 3.1, a generalization of the Area theorem. We shall apply this generalization to the map

$$\psi_{a,b} = (\varphi_{a,b})^{-1}: \mathbb{C} - \bar{D}_r \rightarrow \mathbb{C},$$

where $\log r = H(a,b)$. The map $\psi_{a,b}$ satisfies the assumptions in the following proposition and in Corollary 3.3 of Proposition 3.2.

PROPOSITION 3.1. *If $F: \mathbb{C} - \bar{D}_r \rightarrow \mathbb{C}$ is analytic and injective and*

$$F(z) = z + \sum_{n=2}^{\infty} \frac{\alpha_n}{z^n}, \quad z \in \mathbb{C} - \bar{D}_r,$$

where $r \geq 1$, then

$$\sum_{n=1}^{\infty} \frac{n |\alpha_n|^2}{R^{2n}} \geq R^2$$

for any $R > r$. In particular,

$$|\alpha_n| \leq \frac{r^{n+1}}{\sqrt{n}}, \quad n = 1, 2, \dots$$

Proof. See [A] and [R]. □

PROPOSITION 3.2. *If $f: D_{1/r} \rightarrow \mathbb{C}$ is analytic and injective and*

$$f(z) = z + \sum_{n=2}^{\infty} a_n z^n, \quad z \in D_{1/r},$$

then

$$|a_2| \leq 2r \quad \text{and} \quad f(D_{1/r}) \supset D_{1/4r}.$$

Proof. Again, this is a standard result [R]. □

COROLLARY 3.3. *If $F: \bar{\mathbb{C}} - \bar{D}_r \rightarrow \bar{\mathbb{C}}$ is analytic and injective and*

$$F(z) = z + \sum_{n=1}^{\infty} \frac{\alpha_n}{z^n}, \quad z \in \mathbb{C} - \bar{D}_r,$$

then

$$F(\mathbb{C} - \bar{D}_r) \supset \mathbb{C} - \bar{D}_{2r}.$$

Proof. Let w be a point not in the image of F . Then the map

$$f(z) = \frac{1}{F(z^{-1}) - w} = z + wz^2 + \dots$$

satisfies Proposition 3.2, so $|w| \leq 2r$. □

If $H(P) = \log r$, then

$$\psi_P = (\varphi_P)^{-1}: \bar{C} - \bar{D}_r \rightarrow \bar{C}$$

satisfies Corollary 3.3. (A formal computation gives $\alpha_0 = 0$.) Therefore

$$\psi_P(C - \bar{D}_r) \supset C - \bar{D}_{2r}.$$

Hence the map φ_P is defined on $\bar{C} - \bar{D}_{2r}$, and satisfies Corollary 3.3.

COROLLARY 3.4. *If $H(P) = \log r$, then $\varphi_P(C - \bar{D}_{2r}) \supset C - \bar{D}_{4r}$.*

We can now obtain the following proposition in the *dynamical plane*:

PROPOSITION 3.5. *If $H(\mathbf{a}, b) = \log r \geq 0$, then for every $R \geq r$*

$$L_{\mathbf{a}, b}(R) = \{z \mid h_{\mathbf{a}, b}(z) \leq \log R\} \subset \bar{D}_{2R}.$$

Proof. Let z be given such that $h_{\mathbf{a}, b}(z) \leq \log R$. Since z is not in the image of $\psi_{\mathbf{a}, b}: \bar{C} - \bar{D}_R \rightarrow \bar{C}$ it follows from Corollary 3.3 that $|z| \leq 2R$. □

From this we can obtain the following Proposition in the *parameter space*:

PROPOSITION 3.6. *The set*

$$\mathcal{K}_r = \{(\mathbf{a}, b) \in \mathbf{H} \times \mathbf{C} \mid H(\mathbf{a}, b) \leq \log r\}$$

is compact for every $r \geq 1$ and contained in the compact set

$$K_r = \{(\mathbf{a}, b) \in \mathbf{H} \times \mathbf{C} \mid |a_j| \leq 2r \text{ and } |b| \leq 2(4r)^d\}.$$

Proof. Clearly K_r is compact and \mathcal{K}_r is closed, so what we need to show is that $\mathcal{K}_r \subset K_r$.

Since $a_j \in \{z \mid h_{\mathbf{a}, b}(z) \leq \log r\}$ for every j , we have

$$|a_j| \leq 2r.$$

(1) If $b \notin \psi_{a,b}(\mathbf{C}-\bar{D}_r)$, then $|b| \leq 2r$.

(2) If $0 \notin \psi_{a,b}(\mathbf{C}-\bar{D}_r)$ but $b \in \psi_{a,b}(\mathbf{C}-\bar{D}_r)$, then $h_{a,b}(b) \leq \log r^d$ and $|b| \leq 2r^d$.

(3) If $0, b \in \psi_{a,b}(\mathbf{C}-\bar{D}_r)$, then $\varphi_{a,b}(0)$ is defined, but $\varphi_{a,b}(0) \notin \mathbf{C}-\bar{D}_{4r}$ since $0 \notin \mathbf{C}-\bar{D}_{2r}$ by Corollary 3.4. Hence $h_{a,b}(0) \leq \log 4r$, $h_{a,b}(b) \leq \log(4r)^d$ and finally $|b| \leq 2(4r)^d$. \square

We are particularly interested in the following results:

COROLLARY 3.7. *The connectedness locus \mathcal{C}_d is compact and contained in*

$$K_1 = \{(\mathbf{a}, b) \in \mathbf{H} \times \mathbf{C} \mid |a_j| \leq 2 \text{ and } |b| \leq 2^{2d+1}\}.$$

For $d=3$, K_1 is defined by $|a| \leq 2$ and $|b| \leq 128$. From computer experiments it is known that the b -range for \mathcal{C}_3 is much less.

COROLLARY 3.8. *For $r > 1$ the sets*

$$\mathcal{S}_r = \{(\mathbf{a}, b) \in \mathbf{H} \times \mathbf{C} \mid H(\mathbf{a}, b) = \log r\}$$

and

$$\mathcal{S}_r^j = \{(\mathbf{a}, b) \in \mathcal{S}_r \mid h_{a,b}(a_j) = \log r\}, \quad j = 1, \dots, d-1$$

are compact.

Remark. Since H is continuous it follows that \mathcal{S}_r is outside K_{r_0} if

$$r > \max_{(\mathbf{a}, b) \in K_{r_0}} H(\mathbf{a}, b).$$

Moreover it follows from Proposition 3.6 that H is proper.

Section 4. The mapping φ_p is close to the identity

In this section we shall prove some inequalities, using the generalization of the Area theorem and the Koebe $\frac{1}{4}$ -theorem proved in Section 3 on the maps φ_p and $\psi_p = (\varphi_p)^{-1}$. The results in this section are used in the next section, where we prove that \mathcal{S}_r is homeomorphic to the sphere S^{2d-3} for r sufficiently large. Furthermore the results are used in Section 12, where we prove that for $d=3$ some other subsets \mathcal{S}_r of $\mathbf{C}^2 - \mathcal{C}_3$ are homeomorphic to the sphere \mathcal{S}^3 for r sufficiently large.

All the inequalities more or less follow from the inequality stated in the following proposition.

PROPOSITION 4.1. *If $F: \mathbb{C} - \bar{D}_r \rightarrow \mathbb{C}$ is analytic and injective and*

$$F(z) = z + \sum_{n=1}^{\infty} \frac{a_n}{z^n}, \quad z \in \mathbb{C} - \bar{D}_r,$$

then

$$|F(z) - z| \leq 3 \frac{r^2}{|z|} \quad \text{when } |z| > r.$$

Proof. Since $F(z) - z$ is an analytic function in $\bar{\mathbb{C}} - \bar{D}_r$, which vanishes at ∞ , its maximum on $\bar{\mathbb{C}} - D_R$ is achieved on S_R^1 for any $R > r$. Looking at an R close to r and using Corollary 3.3, we see that this maximum is at most $3r$. So the function

$$g(\zeta) = \frac{1}{3r} \left(F\left(\frac{r}{\zeta}\right) - \frac{r}{\zeta} \right)$$

is an analytic function in the unit disc bounded by 1, and satisfies $|g(\zeta)| < |\zeta|$. Setting $z = r/\zeta$, the inequality follows. \square

Remark. The number 3 in the inequality is sharp. First take $F_0: \mathbb{C} - \bar{D} \rightarrow \mathbb{C} - [-2, 2]$ defined by $F_0(z) = z + z^{-1}$. Let K_ε equal the 3 line segments

$$[-2 + i\varepsilon, 2 + i\varepsilon] \cup [-2 - i\varepsilon, 2 - i\varepsilon] \cup [-2 - i\varepsilon, -2 + i\varepsilon].$$

By the Caratheodory kernel theorem, using symmetry, the uniformization map $F_\varepsilon: \bar{D} \rightarrow \mathbb{C} - K_\varepsilon$ can be chosen to start with $F_\varepsilon(z) = a_\varepsilon z + b_\varepsilon z^{-1} + \dots$ where $a_\varepsilon, b_\varepsilon$ are real and tend to 1 as ε tends in 0. Clearly $F_\varepsilon(1) = -2$.

As in Section 3 consider a polynomial P such that $H(P) = \log r$. Then

$$\psi_P = (\varphi_P)^{-1}: \bar{\mathbb{C}} - \bar{D}_r \rightarrow \bar{\mathbb{C}}$$

and

$$\varphi_P: \bar{\mathbb{C}} - \bar{D}_{2r} \rightarrow \bar{\mathbb{C}}$$

satisfy Proposition 4.1. We therefore have the following two corollaries.

COROLLARY 4.2. *If $H(P) = \log r$, then*

$$|\varphi_P(z) - z| \leq 3 \frac{r^2}{|\varphi_P(z)|} \quad \text{for } |\varphi_P(z)| > r.$$

In particular, $|\varphi_P(z) - z| > 3r$.

Proof. Set $F = \psi_P: \tilde{C} - \tilde{D}_r \rightarrow \tilde{C}$, and use

$$|\varphi_P(z) - z| = |\varphi_P(z) - \psi_P(\varphi_P(z))|. \quad \square$$

COROLLARY 4.3. *If $H(P) = \log r$, then*

$$|\varphi_P(z) - z| \leq 12 \frac{r^2}{|z|} \quad \text{for } |z| > 2r.$$

Proof. Set $F = \varphi_P: \tilde{C} - \tilde{D}_{2r} \rightarrow \tilde{C}$. □

PROPOSITION 4.4. *If $(a, b) \in \mathcal{S}$, and $|z| \geq 6r\sqrt{d+1}$ then*

$$\frac{|P_{a,b}(z) - z^d|}{|z|^d} < \frac{1}{4}.$$

Remark. The number $\frac{1}{4}$ could be replaced by any c with $0 < c < 1$ by changing the constant $6\sqrt{d+1}$.

Proof. For $F: \tilde{C} - \tilde{D}_r \rightarrow \tilde{C}$ satisfying the assumption in Proposition 4.1 we have

$$\frac{|F(z) - z|}{|z|} \leq 3 \frac{r^2}{|z|^2} < 1 \quad \text{for } |z| > \sqrt{3}r.$$

Using

$$|\text{Log}(1+t)| < \frac{|t|}{1-|t|} \quad \text{for } |t| < 1$$

we get for $|z| > 2\sqrt{3}r$ that

$$\left| \text{Log} \frac{F(z)}{z} \right| = \left| \text{Log} \left(1 + \frac{F(z) - z}{z} \right) \right| \leq \frac{3r^2/|z|^2}{1-3r^2/|z|^2} < 4 \frac{r^2}{|z|^2}.$$

From Corollary 3.3 we know that

$$\mathbf{C} - \tilde{D}_{8r} \subset F(\mathbf{C} - \tilde{D}_{4r}).$$

Set $P=P_{a,b}$, $\varphi=\varphi_{a,b}$ and $F=\varphi^{-1}$, and choose z with $|z|>8r$. Then $w=\varphi(z)$ is defined and $|w|>4r$. Therefore

$$\left| \operatorname{Log} \frac{\varphi(z)}{z} \right| = \left| \operatorname{Log} \frac{F(w)}{w} \right| < 4 \frac{r^2}{|w|^2} < 6 \frac{r^2}{|z|^2}.$$

In the last inequality we have used

$$\frac{|z|}{|w|} = \left| 1 + \frac{F(w)-w}{w} \right| \leq 1 + 3 \frac{r^2}{|w|^2} < \frac{19}{16}.$$

Furthermore

$$\left| \operatorname{Log} \frac{\varphi(P(z))}{z^d} \right| = d \left| \operatorname{Log} \frac{\varphi(z)}{z} \right| < 6d \frac{r^2}{|w|^2}.$$

and

$$\left| \operatorname{Log} \frac{\varphi(P(z))}{P(z)} \right| < 4 \frac{r^2}{|\varphi(P(z))|^2} = 4 \frac{r^2}{|w|^{2d}} < 4 \frac{r^2}{|w|^2} < 6 \frac{r^2}{|z|^2}.$$

Then

$$\left| \operatorname{Log} \frac{P(z)}{z^d} \right| < 6(d+1) \frac{r^2}{|z|^2}.$$

If $|z|>6r\sqrt{d+1}$, then

$$\left| \operatorname{Log} \frac{P(z)}{z^d} \right| < \frac{1}{6}$$

and

$$\frac{|P(z)-z^d|}{|z|^d} < \frac{1}{4}. \quad \square$$

COROLLARY 4.5. *If $H(a,b)=\log r$ and $|z|\geq 6r\sqrt{d+1}$ then $|P(z)|>|z|$. In particular this will occur if $|\varphi(z)|\geq 3(1+2\sqrt{d+1})r$.*

Proof. If $|z|\geq 6r\sqrt{d+1}$ we have

$$|P(z)| \geq |z|^d - |P(z)-z^d| > \frac{3}{4}|z|^d.$$

So $|P(z)|>|z|$ as soon as $|z|<\frac{3}{4}|z|^d$, i.e. $|z|>(\frac{4}{3})^{1/(d-1)}$ which will in any case be true if $|z|>6$.

From Corollary 4.2 we have that $|\varphi(z)-z|<3r$, hence if $|\varphi(z)|\geq 3(1+2\sqrt{d+1})r$ we have

$$|z| \geq |\varphi(z)| - |\varphi(z) - z| > 6r\sqrt{d+1}. \quad \square$$

Section 5. The high level sets of H are spheres

In this section we shall prove that the compact set

$$\mathcal{S}_r = \{(a, b) \in \mathbf{H} \times \mathbf{C} \mid H(a, b) = \log r\}$$

is homeomorphic to the sphere S^{2d-3} for r sufficiently large. It may be true for all $r > 1$, but we know this only if $d=2$ or $d=3$.

The case $d=2$ is proved in [D-H2, VIII]. The proof in the case $d=3$ will be finished in Section 11, where we shall prove that

$$H: \mathbf{C}^2 - \mathcal{C}_3 \rightarrow (0, \infty)$$

is a fibration (with fibers \mathcal{S}_r).

Let γ denote the following action of \mathbf{C} on $\mathbf{H} \times \mathbf{C}$:

$$\gamma(t, (a, b)) = \gamma_{a,b}(t) = (ta, t^d b).$$

This definition is chosen since we have the following connection between the polynomials $P_{a,b}$ and $P_{ta, t^d b}$

$$P_{ta, t^d b}(tz) = t^d P_{a,b}(z).$$

In particular, the critical points of $P_{ta, t^d b}$ are $\{ta_1, \dots, ta_{d-1}\}$.

These properties imply an approximate homogeneity on the dynamic behavior of polynomials, at least for large t ; the object of this section is to exploit this ‘‘homogeneity’’.

We will be interested in the curves $\gamma_{a,b}(t)$ for fixed $(a, b) \neq (0, 0)$ and t real and positive. Along each such curve $\gamma_{a,b}$ the distance to the origin $(0, 0)$ is an increasing function of t . Therefore each curve $\gamma_{a,b}$ intersects any sphere in $\mathbf{H} \times \mathbf{C}$ centered at the origin, for instance the unit sphere S^{2d-3} , at a unique point.

Each curve $\gamma_{a,b}$ also intersects every γ_r , $r > 1$, by the intermediate value theorem. Indeed, by Corollary 1.3, H is continuous; $H(\gamma_{a,b}(0)) = H(P_0) = 0$, and $H(\gamma_{a,b}(t)) \rightarrow \infty$ when $t \rightarrow \infty$, since H is proper by Proposition 3.6.

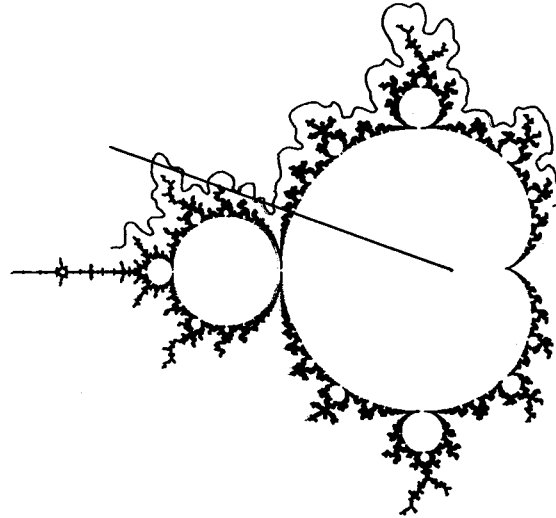

Fig. 5.1

A curve $\gamma_{a,b}$ might intersect \mathcal{S}_r in more than one point, and in fact they do, even for quadratic polynomials, if τ is close to 1 (see Figure 5.1). But we shall show that for r sufficiently large, there is a **unique** intersection point, giving a 1-1 correspondence between \mathcal{S}_r and S^{2d-3} .

PROPOSITION 5.1. *For each $(a, b) \neq (0, 0)$ the function $H(\gamma_{a,b}(t))$ is increasing in t for t sufficiently large.*

Note that (a, b) is fixed in the proposition. We shall deal with the uniformity problem in (a, b) in Proposition 5.5.

For a fixed (a, b) we shall denote

$$P = P_{a,b}, \quad P_t = P_{ta, t^d b}, \quad h = h_{a,b},$$

$$h_t = P_{ta, t^d b}, \quad \varphi = \varphi_{a,b}, \quad \varphi_t = \varphi_{ta, t^d b}.$$

Proposition 5.1 follows from the following two lemmas:

LEMMA 5.2. *For any $P = P_{a,b}$ with $H(P) = \log r$, the map $z \mapsto \varphi_t(P_t(tz))$ is defined for those z with $|P(z)| \geq 6r\sqrt{d+1}$ and for $|t| \geq 1$. In particular, it is defined for a_j with*

$$|P(a_j)| \geq 6r\sqrt{d+1}.$$

LEMMA 5.3. If $r \geq 11$ and $H(P) = \log r$, and if a_j satisfies $H(P) = h(a_j)$, then $|P(a_j)| \geq 6r\sqrt{d+1}$.

Proof of Lemma 5.2. We will prove that

$$\frac{|Q_t(P_t^{\circ n}(tz))|}{|(P_t^{\circ n}(tz))^d|} < \frac{1}{4} \quad \text{for } n = 1, 2, \dots$$

for every z such that $|P(z)| \geq 6r\sqrt{d+1}$, where $Q_t(z) = P_t(z) - z^d$. Set $u_{n+1} = t^{d-1}P(u_n)$ and $u_1 = t^{d-1}P(z)$, and see by induction that $P_t^{\circ n}(tz) = tu_n$ and

$$Q_t(P_t^{\circ n}(tz)) = Q_t(tu_n) = t^d Q(u_n).$$

Then

$$\frac{|Q_t(P_t^{\circ n}(tz))|}{|(P_t^{\circ n}(tz))^d|} = \frac{|Q_t(tu_n)|}{|(tu_n)^d|} = \frac{|Q(u_n)|}{|u_n^d|} < \frac{1}{4} \quad (1)$$

if

$$|u_n| \geq 6r\sqrt{d+1}$$

by Proposition 4.4. This will be true for $n \geq 1$ if

$$|u_1| \geq 6r\sqrt{d+1},$$

since

$$|u_{n+1}| = t^{d-1}|P(u_n)| \geq |P(u_n)| > |u_n| \geq |P(z)|,$$

by Corollary 4.5 and induction.

The function $\varphi_t(P_t(tz))$ is defined by

$$\varphi_t(P_t(tz)) = P_t(tz) \prod_{n=1}^{\infty} \left(1 + \frac{Q_t(P_t^{\circ n}(tz))}{(P_t^{\circ n}(tz))^d} \right)^{1/d^{n+1}}.$$

The inequality (1) shows that the principal branch of the root is defined if $|P(z)| \geq 6r\sqrt{d+1}$. Taking log of the absolute value the factor $1/d^{n+1}$ gives the convergence. \square

Proof of Lemma 5.3. If $(a, b) \notin \mathcal{C}_d$, then

$$|P(a_j)| \geq |\varphi(P(a_j))| - |P(a_j) - \varphi(P(a_j))| \geq r^d - 3 \frac{r^2}{|\varphi(P(a_j))|} = r^d - 3 \frac{r^2}{r^d} \geq r^d - 3,$$

so $|P(a_j)| \geq 6r\sqrt{d+1}$ as soon as $r^d - 3 \geq 6r\sqrt{d+1}$, which is true if $r \geq 11$ for all $d \geq 2$. \square

Proof of Proposition 5.1. Pick a fixed $(a, b) \neq (0, 0)$ and choose t_0 so that $H(P_t) \geq \log 11$ for $t > t_0$. Consider those a_j such that for some $t_j, t_j > t_0$, we have

$$H(P_{t_j}) = h_{t_j}(t_j a_j).$$

Then $\varphi_t(P_t(a_j))$ is defined and analytic for all complex t satisfying $|t| > t_j$. Moreover, this function has a pole of order d at ∞ , so its modulus is increasing for $|t|$ sufficiently large, and $H(P_t)$ is the supremum of a finite family of increasing functions. \square

PROPOSITION 5.4. *If $H(ta, t^d b) \geq \log 3$ for all $t \geq 1$ and if a is a critical point with $h(P(a)) < \log(r^d/4)$, then $h_t(ta) < H(P_t)$ for all $t \geq 1$.*

Remarks. (a) For a quadratic polynomial this can never occur since there is a unique critical point.

(b) The hypothesis, $H(ta, t^d b) \geq \log 3$ for all $t \geq 1$, is satisfied if $|a_j| > 6$ for some j or $|b| > 2(12)^d$.

Proof. Suppose the proposition is false. Then there exists a $t > 1$ such that $h_t(ta) \geq H_t(P_t)$. Therefore by continuity there exists a $t_0 > 1$ such that $h_{t_0}(t_0 a) = H_{t_0}(P_{t_0})$. Suppose that $H(a, b) = h(a_1)$.

It follows from Proposition 3.5 that $|P(a)| < \frac{1}{2}r^d$ and from Corollary 4.2 that

$$|P(a_1)| \geq |\varphi(P(a_1))| - |\varphi(P(a_1)) - P(a_1)| \geq r^d - 3r^{2-d}.$$

Therefore

$$|P(a_1)| - |P(a)| \geq r^d - 3 - \frac{1}{2}r^d > 12$$

and hence

$$|P_t(ta_1)| - |P_t(ta)| > 12t^d \quad \text{for all } t \geq 1.$$

On the other hand

$$|\varphi_{t_0}(P_{t_0}(t_0 a))| \geq |\varphi_{t_0}(P_{t_0}(t_0 a_1))|$$

by assumption. ($\varphi_{t_0}(P_{t_0}(t_0 a))$ is defined since $H(t_0 \mathbf{a}, t_0^d b) = h_{t_0}(t_0 a)$ for the given t_0 and $\varphi_t(P_t(ta_1))$ is defined for every $t \geq 1$.) Set $h_{t_0}(t_0 a) = r_0$. It follows from Corollary 4.2 that

$$|\varphi_{t_0}(P_{t_0}(t_0 a)) - P_{t_0}(t_0 a)| \leq 3r_0^{2-d} \leq 1$$

and therefore that

$$|\varphi_{t_0}(P_{t_0}(t_0 a))| < |P_{t_0}(t_0 a)| + 1.$$

Moreover

$$|P_{t_0}(t_0 a_1)| > |P_{t_0}(t_0 a)| \geq r_0^d - 3r_0^{2-d} > \frac{1}{2}r_0^d$$

so that we can use Corollary 4.3 and get

$$|\varphi_{t_0}(P_{t_0}(t_0 a_1)) - P_{t_0}(t_0 a_1)| \leq \frac{12r_0^2}{|P_{t_0}(t_0 a_1)|} < 24r_0^{2-d} < 8$$

for $r_0 \geq 3$. Therefore

$$|\varphi_{t_0}(P_{t_0}(t_0 a_1))| > |P_{t_0}(t_0 a_1)| - 8.$$

Hence $|P_{t_0}(t_0 a_1)| - |P_{t_0}(t_0 a)| < 8 + 1 < 12$, which is a contradiction. \square

PROPOSITION 5.5. *There exists a t_0 such that for all $(\mathbf{a}, b) \in \mathcal{S}_r$ with $r \geq 11$ the function $H(\gamma_{\mathbf{a}, b}(t))$ is an increasing function of t for all $t \geq t_0$.*

Proof. Let \mathcal{S}_r be divided into subsets

$$A_j = \{(\mathbf{a}, b) \in \mathcal{S}_r \mid P_{\mathbf{a}, b}(a_j) \geq 6r\sqrt{d+1}\}.$$

Each set A_j is a compact set, and the mappings

$$g_{j,(\mathbf{a}, b)}: \mathbf{C} - \tilde{D} \rightarrow \mathbf{C}$$

defined by

$$g_{j,(\mathbf{a}, b)}(t) = \varphi_{t\mathbf{a}, t^d b}(P_{t\mathbf{a}, t^d b}(ta_j))$$

is therefore a compact family, parametrized by (\mathbf{a}, b) , of analytic functions on $\mathbf{C} - \tilde{D}$. Each map $g_{j,(\mathbf{a}, b)}$ has a pole of order d at ∞ .

Suppose the proposition is false. Then there exists a sequence $(t_n, (a_n, b_n))$ such that $t_n \rightarrow \infty$ and

$$\frac{d}{dt} h_{t_n, r^{d_b}}(P_{t_n, r^{d_b}}(ta_j)) = 0 \quad \text{for } (t, (a, b)) = (t_n, (a_n, b_n)).$$

Assume (a_n, b_n) converges to (a_0, b_0) (if not extract a converging subsequence). But then $g_{j, (a_0, b_0)}$ would have a pole of order different from d at ∞ , which is a contradiction. Hence there exists a t_j such that the map $h_{t, r^{d_b}}(ta_j)$ is monotone increasing for all $t \geq t_j$ and for every $(a, b) \in A_j$.

Set $t_0 = \max \{t_j\}$. □

THEOREM 5.6. *There exists an r_0 such that $\mathcal{S}_r \simeq S^{2d-3}$ for any $r \geq r_0$.*

Proof. Set $\log r_0 = \sup_{(a, b) \in \mathcal{S}_{11}} H(\gamma_{a, b}(t_0))$ with t_0 as in Proposition 5.5. The number r_0 is well defined since the map is continuous and \mathcal{S}_{11} is compact. If we choose $r \geq r_0$ and $(a, b) \in S^{2d-3}$, then each curve $\gamma_{a, b}(t)$ intersects \mathcal{S}_r at a unique point. Consider the map

$$F_r: S^{2d-3} \rightarrow \mathcal{S}_r$$

which associates to (a, b) the corresponding point of intersection. This map is bijective, both S^{2d-3} and \mathcal{S}_r are compact, and F_r^{-1} is continuous, so F_r is a homeomorphism. □

Chapter II. Wringing the complex structure

Introduction

In [S], Sullivan introduced the use of the *Measurable Riemann Mapping Theorem* into the theory of rational functions. We will make crucial use of this technique.

The theorem, due to Ahlfors and Bers [A-B], is the following.

THE MEASURABLE RIEMANN MAPPING THEOREM. (a) *Let σ_μ be any measurable almost complex structure on $\bar{\mathbb{C}}$, defined by a Beltrami form $\mu = u(z) d\bar{z}/dz$. Suppose σ_μ has bounded dilatation ratio with respect to the standard complex structure σ_0 , i.e. $\|\mu\|_\infty < 1$. Then there exists a unique quasi-conformal homeomorphism $w_\mu: \mathbb{C} \rightarrow \mathbb{C}$ which is an analytic isomorphism*

$$w_\mu: (\bar{\mathbb{C}}, \sigma_\mu) \rightarrow (\bar{\mathbb{C}}, \sigma_0),$$

and fixes 0, 1 and ∞ .

(b) Let $\mu(\lambda) = u_\lambda d\bar{z}/dz$ be a family of Beltrami forms depending analytically on $\lambda \in \mathbb{C}^n$. This means that $u_\lambda(z)$ depends analytically on λ for fixed z . If $\|\mu(\lambda)\|_\infty \leq K < 1$ then $w_{\mu(\lambda)}(z)$ is analytic in λ for all z .

(c) Let $\mu(\lambda) = u_\lambda(z) d\bar{z}/dz$ be a family of Beltrami forms depending on a parameter λ , which in this case could be in any topological space. If $\|u_\lambda\|_\infty \leq K < 1$ for all λ and if $u_\lambda: \bar{C} \rightarrow \bar{C}$ is continuous in the L^1 -norm with respect to the spherical measure on \bar{C} , then $w_{\mu(\lambda)}(z)$ is a continuous function of λ and z .

The classical statement of the theorem does not use the language ‘‘analytic with respect to an almost complex structure’’. For a translation to the classical language, see [D-H3].

We will construct families of polynomials by taking a polynomial P and varying the complex structure on $\mathbb{C} - K_P$ in a specific way, described as the *wring* in Section 8. In Section 6 we will describe the appropriate normalization of a mapping

$$f_\mu: (\bar{C}, \sigma_\mu) \rightarrow (\bar{C}, \sigma_0)$$

analytic as above, required to keep $P_\mu = f_\mu \circ P \circ f_\mu^{-1}$ in \mathcal{P}_d when μ is P -invariant. In Section 7 we will investigate the dependence of P_μ on μ , which is fairly easy using (b) above. In Section 9 we will investigate the dependence of P_μ with respect to P for good P 's, which is harder. Then in Section 10 we deal with the bad P 's, which is harder yet; this is where degree 3 becomes essential.

Section 6. Beltrami-forms invariant under a polynomial

In this section we will show that if $P \in \mathcal{P}_d$ and if μ is a P -invariant Beltrami-form, then the analytic mapping

$$P(\mathbb{C}, \sigma_\mu) \rightarrow (\mathbb{C}, \sigma_\mu)$$

can be viewed as a new polynomial. In fact, by making an appropriate change of variables, this new polynomial can be made an element of \mathcal{P}_d .

Rather than work with general P -invariant Beltrami forms, we will use those obtained from the construction below. In fact, they can all be obtained by this construction, but we will not need this result. We will see in Section 8 that P -invariance is a very strong restriction, in some sense there is only a 1-parameter family of such Beltrami forms, up to ‘‘trivial’’ terms.

Let $P_0(z) = z^d$ and let $l: \mathbb{C} - \bar{D} \rightarrow \mathbb{C} - \bar{D}$ be any diffeomorphism (or more generally quasi-conformal homeomorphism) such that the diagram

$$\begin{array}{ccc} \mathbb{C} - \bar{D} & \xrightarrow{P_0} & \mathbb{C} - \bar{D} \\ l \downarrow & & \downarrow l \\ \mathbb{C} - \bar{D} & \xrightarrow{P_0} & \mathbb{C} - \bar{D} \end{array}$$

commutes. Let $\sigma_l = l^*(\sigma_0)$, where σ_0 denotes the standard complex structure. The complex structure σ_l is P_0 -invariant by construction, i.e. $P_0: (\mathbb{C} - \bar{D}, \sigma_l) \rightarrow (\mathbb{C} - \bar{D}, \sigma_l)$ is analytic. Suppose l is quasiconformal, i.e. σ_l has bounded dilatation ratio with respect to σ_0 , say bounded by k . Let P be any monic polynomial of degree d and let $\sigma_{l,P}$ denote the P -invariant almost complex structure corresponding to the Beltrami form $\mu_{l,P}$ satisfying

$$\sigma_{l,P} = \begin{cases} \varphi_P^*(\sigma_l) & \text{on } U_P \\ \sigma_0 & \text{on } K_P \end{cases}$$

The complex structure $\sigma_{l,P}$ is P -invariant on U_P by construction and it is well defined at points in $\mathbb{C} - \cup P^{-n}(\Omega_\infty)$, where Ω_∞ is the set of critical points for P in \mathbb{C} which are attracted to ∞ . Use the P -invariance on U_P and the fact that to each $z \in \mathbb{C} - (K_P \cup P^{-n}(\Omega_\infty))$ there exists an m such that $P^{\circ m}(z) \in U_P$, furthermore z is a regular point for $P^{\circ m}$. Since the dilatation ratio with respect to σ_0 is not changed by pull back through a map which is analytic with respect to σ_0 , then $\sigma_{l,P}$ has dilatation ratio bounded by k too.

The following proposition gives a normalization of an isomorphism

$$v_{l,P}: (\bar{\mathbb{C}}, \sigma_{l,P}) \rightarrow (\bar{\mathbb{C}}, \sigma_0)$$

appropriate to our purposes.

PROPOSITION 6.1. *If $P \in \mathcal{P}_d$ and $\sigma_{l,P}$ is as above, then there exists a unique analytic isomorphism*

$$v_{l,P}: (\bar{\mathbb{C}}, \sigma_{l,P}) \rightarrow (\bar{\mathbb{C}}, \sigma_0)$$

such that

- (1) $v_{l,P}(\infty) = \infty$
- (2) $P_l = v_{l,P} \circ P \circ v_{l,P}^{-1} \in \mathcal{P}_d$
- (3) $l \circ \varphi_P \circ v_{l,P}^{-1}$ is tangent to the identity at ∞ .

Remark. (1) We shall refer to $v_{l,P}$ as the *normalized analytic isomorphism from $(\bar{C}, \sigma_{l,P})$ to (\bar{C}, σ_0)* and to the polynomial P_l as the *polynomial induced by l from P* (or simply by l when P is fixed in the discussion).

(2) The conditions (1) and (2) determine $v_{l,P}$ up to $d-1$ choices, for each of which the map

$$l \circ \varphi_P \circ v_{l,P}^{-1}$$

conjugates P_l to P_0 near ∞ , corresponding to the $d-1$ maps satisfying (1) in Proposition 1.4.

Proof. Set $\mu = \mu_{l,P}$.

Existence. Choose the map w_μ . Then (1) is satisfied, and the map $w_\mu \circ P \circ w_\mu^{-1}$ is a polynomial of degree d . Suppose

$$w_\mu \circ P \circ w_\mu^{-1}(z) = c_0 z^d + c_1 z^{d-1} + \dots + c_d.$$

If $c_0 \neq 1$, then choose an arbitrary $(d-1)$ -root of c_0 , $c_0^{1/(d-1)}$, and set

$$f_\mu(z) = c_0^{1/(d-1)} w_\mu(z) + c_1/d(c_0^{1/(d-1)})^{d-2}.$$

The polynomial $f_\mu \circ P \circ f_\mu^{-1}$ satisfies (2). The map

$$l \circ \varphi_P \circ f_\mu^{-1}: f_\mu(U_P) \rightarrow l \circ \varphi_P(U_P)$$

is by construction an analytic isomorphism with respect to the standard complex structure σ_0 . It follows from the commutative diagram

$$\begin{array}{ccccccc}
 f_\mu(U_P), \sigma_0 & \xrightarrow{f_\mu^{-1}} & U_P, \sigma_{l,P} & \xrightarrow{\varphi_P} & C-\bar{D}, \sigma_l & \xrightarrow{l} & C-\bar{D}, \sigma_0 \\
 \downarrow f_\mu \circ P \circ f_\mu^{-1} & & \downarrow P & & \downarrow P_0 & & \downarrow P_0 \\
 f_\mu(U_P), \sigma_0 & \xrightarrow{f_\mu^{-1}} & U_P, \sigma_{l,P} & \xrightarrow{\varphi_P} & C-\bar{D}, \sigma_l & \xrightarrow{l} & C-\bar{D}, \sigma_0
 \end{array}$$

that the map $l \circ \varphi_P \circ f_\mu^{-1}$ conjugates the monic polynomial $f_\mu \circ P \circ f_\mu^{-1}$ to P_0 in the neighborhood $f_\mu(U_P)$ of ∞ . For a monic polynomial of degree d there are only $(d-1)$ possibilities. The conjugating map is tangent to multiplication by a $(d-1)$ -root of unity δ at infinity.

Set $v_{l,P}(z) = f_\mu(\delta z)$; then $v_{l,P}$ satisfies the requirements of Proposition 6.1.

Uniqueness. Suppose $v' = v'_{l,P}$ and $v'' = v''_{l,P}$ satisfy (1), (2), (3). Then

$$v'' \circ (v')^{-1}: (\bar{C}, \sigma_0) \rightarrow (\bar{C}, \sigma_0)$$

is an affine transformation. In a neighborhood of ∞ , $v'' \circ (v')^{-1}$ equals

$$(l \circ \varphi_P \circ (v'')^{-1})^{-1} \circ (l \circ \varphi_P \circ (v')^{-1})$$

and is therefore tangent to the identity at ∞ , hence $v'' \circ (v')^{-1}$ is a translation. Since the two polynomials

$$v' \circ P \circ (v')^{-1} \quad \text{and} \quad v'' \circ P \circ (v'')^{-1}$$

are in \mathcal{P}_d , they have no term of degree $(d-1)$, therefore the conjugating map $v'' \circ (v')^{-1}$ is the identity. □

Remark. The construction in the existence proof works for any P -invariant $\sigma_{l,P} = \varphi_P^*(\sigma_l)$ on U_P with bounded dilatation ratio.

We did not use $\sigma_{l,P} = \sigma_0$ on K_P . The proof for uniqueness of v works as well. We only used that $v: (\bar{C}, \sigma_{l,P}) \rightarrow (\bar{C}, \sigma_0)$ is an analytic isomorphism satisfying (1), (2) and (3).

Note finally that $v_{l,P}$ depends on l and not just on $\mu_{l,P}$.

Section 7. Analytic dependence on parameters

In this section, we will let the diffeomorphism l of Section 6 depend analytically on a parameter, but keep the polynomial P fixed.

LEMMA 7.1. *Let $l_\lambda: \mathbb{C} - \bar{D} \rightarrow \mathbb{C} - \bar{D}$ be a family of diffeomorphisms, analytic in λ . If $P \in \mathcal{P}_d$, then the induced Beltrami form $\mu_{\lambda,P} = \mu_{l_\lambda,P}$ is analytic in λ .*

Proof. In the domain of φ_P the Beltrami form $\mu_{\lambda,P}$ is

$$\varphi_P^* \left(\frac{\partial l_\lambda / \partial z}{\partial l_\lambda / \partial \bar{z}} \right)$$

hence analytic in λ if l is.

Elsewhere in $\mathbf{C}-K_P$, $\mu_{\lambda,P}$ is the pull-back by an iterate of P of the Beltrami-form above, still analytic in λ , and finally on K_P , we have $\mu_{\lambda,P}=0$, also analytic. \square

In Proposition 6.1 we proved that to any given polynomial $P \in \mathcal{P}_d$ and to any given diffeomorphism $l: \mathbf{C}-\bar{D} \rightarrow \mathbf{C}-\bar{D}$ we can construct another polynomial in \mathcal{P}_d . Let the polynomial P be given by a parameter value (\mathbf{a}, b) , let $l_\lambda: \mathbf{C}-\bar{D} \rightarrow \mathbf{C}-\bar{D}$ be given. Set $v_{l_\lambda,P}=v_{\lambda,P}$ and $a_{j,\lambda}=v_{\lambda,P}(a_j)$, $\mathbf{a}_\lambda=(a_{1,\lambda}, \dots, a_{d-1,\lambda})$ and let b_λ be determined by

$$v_{\lambda,P} \circ P_{\mathbf{a},b} \circ v_{\lambda,P}^{-1} = P_{\mathbf{a}_\lambda, b_\lambda}.$$

PROPOSITION 7.2. *If l_λ is a family of diffeomorphisms, analytic in λ , commuting with P_0 , then for a given $(\mathbf{a}, b) \in \mathbf{H} \times \mathbf{C}$ with $P = P_{\mathbf{a},b}$ the map $\lambda \mapsto v_{\lambda,P}(z)$ is analytic in λ for all z and $\lambda \mapsto (\mathbf{a}_\lambda, b_\lambda)$ is analytic in λ .*

Proof. Set $\mu_{\lambda,P} = \mu(\lambda)$.

Case (i): $\mathbf{a} = \mathbf{0}$. If $\mathbf{a} = \mathbf{0}$, then $P(z) = z^d + b$ and the polynomial

$$w_{\mu(\lambda)} \circ P \circ w_{\mu(\lambda)}^{-1}(z) = \gamma_\lambda(z^d + \beta_\lambda).$$

Since $w_{\mu(\lambda)}$ fixes 0 and 1, we have

$$w_{\mu(\lambda)}(P(0)) = \gamma_\lambda \beta_\lambda$$

$$w_{\mu(\lambda)}(P(1)) = \gamma_\lambda (1 + \beta_\lambda).$$

Since $w_{\mu(\lambda)}(P(0))$ and $w_{\mu(\lambda)}(P(1))$ are analytic in λ , it follows that γ_λ and β_λ are analytic in λ too.

Case (ii): $\mathbf{a} \neq \mathbf{0}$. If $\mathbf{a} \neq \mathbf{0}$, then consider the mapping

$$f_{\mu(\lambda)}(z) = w_{\mu(\lambda)}(z) - \frac{1}{d-1} \sum_{j=1}^{d-1} w_{\mu(\lambda)}(a_j),$$

which is analytic in λ for all z . The critical points for the polynomial $f_{\mu(\lambda)} \circ P \circ f_{\mu(\lambda)}^{-1}(z)$ are $f_{\mu(\lambda)}(a_j)$, centered at 0. A polynomial with critical points a_j centered at 0 has the form

$$\gamma(z^d + (-1)^2 \frac{d}{d-2} \sigma_2(\boldsymbol{\alpha}) z^{d-2} + \dots + (-1)^{d-1} d \sigma_{d-1}(\boldsymbol{\alpha}) z + \beta).$$

Suppose

$$f_{\mu(\lambda)} \circ P \circ f_{\mu(\lambda)}^{-1}(z) = \gamma_\lambda(z^d + (-1)^2 \frac{d}{d-2} \sigma_2(\alpha_\lambda) z^{d-2} + \dots + (-1)^{d-1} d \sigma_{d-1}(\alpha_\lambda) z + \beta_\lambda),$$

where $\alpha_\lambda = (\alpha_{1,\lambda}, \dots, \alpha_{d-1,\lambda}) = (f_{\mu(\lambda)}(a_1), \dots, f_{\mu(\lambda)}(a_{d-1}))$.

The critical values for the polynomial $f_{\mu(\lambda)} \circ P \circ f_{\mu(\lambda)}^{-1}$ are

$$f_{\mu(\lambda)}(P(a_j)) = \gamma_\lambda(\alpha_{j,\lambda}^d + \dots + \beta_\lambda).$$

Since $\alpha_{j,\lambda} = f_{\mu(\lambda)}(a_j)$ and $f_{\mu(\lambda)}(P(a_j))$ are analytic in λ and since there exists (i, j) such that $a_i \neq a_j$ and $P(a_i) \neq P(a_j)$, hence $f_{\mu(\lambda)}(a_i) \neq f_{\mu(\lambda)}(a_j)$ and $f_{\mu(\lambda)}(P(a_i)) \neq f_{\mu(\lambda)}(P(a_j))$, it follows that γ_λ and β_λ are analytic in λ too.

On any open simply connected set Λ choose a branch of the $(d-1)$ -root of γ_λ . The map $\gamma_\lambda^{1/(d-1)} f_{\mu(\lambda)}(z)$ is an analytic function of $\lambda \in \Lambda$ for every z . This is the new $f_{\mu(\lambda)}$ -map for $\lambda \in \Lambda$ and all the mappings $l_\lambda \circ \varphi_P \circ f_{\mu(\lambda)}^{-1}$ for $\lambda \in \Lambda$ are tangent at ∞ to multiplication by a $(d-1)$ th root of unity δ ; compose with $z \rightarrow \delta z$.

As a result we have shown that $v_{\lambda,P}(z)$ is analytic in λ for all z and that the coefficients in the polynomial $v_{\lambda,P} \circ P \circ v_{\lambda,P}^{-1}$ are analytic in λ too. \square

Remark. The conclusions in Proposition 7.2 are true for any P -invariant family $\sigma_{\lambda,P}$ of almost complex structures, analytic in λ , where $\sigma_{\lambda,P} = \varphi_P^*(\sigma_{l_\lambda})$ on U_P .

We did not use that $\sigma_{\lambda,P} = \sigma_0$ on K_P , only that $\sigma_{\lambda,P}$ is analytic in λ . We will use this remark in Section 10.

Section 8. Stretching and wringing the complex structure

We shall now study a particular one-parameter family of diffeomorphisms l_ζ , which depend analytically on the parameter ζ .

Let $G = \{\varrho + i\theta \mid \varrho > 0, \theta \in \mathbb{R}\}$ be the right halfplane. Then the map $\exp: G \rightarrow \mathbb{C} - \bar{D}$ is a universal covering of $\mathbb{C} - \bar{D}$.

Let $G \rightarrow \mathfrak{M}_2$ be the map

$$\varrho + i\theta \mapsto \begin{bmatrix} \varrho & 0 \\ \theta & 1 \end{bmatrix}$$

and let $*$ be the composition in G corresponding to matrix multiplication in \mathfrak{M}_2 , i.e.

$$(u+iv) \star (s+it) = us + i(vs+t) = (u+iv)s + it.$$

Then (G, \star) is a group. For each ζ in G let $l_\zeta: G \rightarrow G$ be left multiplication by $\zeta = s+it$:

$$l_\zeta(\rho+i\theta) = s\rho + i(t\rho+\theta).$$

This bijection projects to a diffeomorphism

$$l_\zeta: \mathbb{C}-\bar{D} \rightarrow \mathbb{C}-\bar{D}.$$

Furthermore l_ζ commutes with P_0 , and the dilatation ratio for $\sigma_\zeta = l_\zeta^*(\sigma_0)$ is constant, since the dilatation ratio of l_ζ is constant in the right half plane.

Remark. The family of mappings l_ζ is a complete set of maps

$$\mathbb{C}-\bar{D} \rightarrow \mathbb{C}-\bar{D}$$

which commute with P_0 up to trivial maps in the following sense: any such mapping can be deduced from one of the form

$$\rho+i\theta \mapsto s\rho + \alpha(\rho) + i(\theta + t\rho + \beta(\rho))$$

where $\alpha(d\rho) = d\alpha(\rho)$ and $\beta(d\rho) = d\beta(\rho)$.

The map l_ζ changes the complex structure σ_0 to σ_ζ by stretching and turning (i.e. wringing it).

For a pure stretch ($s \neq 1, t=0$) the geometrical picture is simple. The family of infinitesimal ellipses, which defines σ_ζ , is the family of ellipses, where the major (minor) axes are along the radial lines if $s < 1$ ($s > 1$ respectively), and where the ratio of the major to the minor axis equals $1/s$ (s respectively). The general statement is found in the following lemma.

LEMMA 8.1. *The family $l_\zeta: \mathbb{C}-\bar{D} \rightarrow \mathbb{C}-\bar{D}$ of diffeomorphisms defined above is analytic in ζ . The complex dilatation ratio for σ_ζ equals*

$$\frac{\zeta-1}{\zeta+1} \frac{z}{\bar{z}} \frac{dz}{d\bar{z}}$$

Proof. The coordinate $u = \rho + i\theta$ is an analytic complex coordinate in the right half plane. In this coordinate, $l_\zeta(\rho+i\theta) = \rho\zeta + i\theta$, which is analytic in ζ . Furthermore the complex dilatation ratio is the quotient of

$$\frac{\partial l_\zeta}{\partial \bar{u}} = \frac{1}{2} \left(\frac{\partial l_\zeta}{\partial \rho} + i \frac{\partial l_\zeta}{\partial \theta} \right) = \frac{1}{2} (\zeta - 1)$$

$$\frac{\partial l_\zeta}{\partial u} = \frac{1}{2} \left(\frac{\partial l_\zeta}{\partial \rho} - i \frac{\partial l_\zeta}{\partial \theta} \right) = \frac{1}{2} (\zeta + 1).$$

□

Let $(a, b) \in \mathbf{H} \times \mathbf{C}$ be given and $P = P_{a,b}$.

Let $\sigma_{\zeta,P}$ be the P -invariant almost complex structure satisfying

$$\sigma_{\zeta,P} = \begin{cases} \varphi_P^*(\sigma_\zeta) & \text{on } U_P \\ \sigma_0 & \text{on } K_P \end{cases}$$

and corresponding to the Beltrami form $\mu_{\zeta,P}$.

As in the last section let $v_{\zeta,P} = v_{l_\zeta,P}$, $a_{j,\zeta} = v_{\zeta,P}(a_j)$ and let $v_{\zeta,P} \circ P \circ v_{\zeta,P}^{-1} = P_{a_\zeta, b_\zeta}$. We shall use the short notation P_ζ for this polynomial, when it is clear what the omitted (a, b) is.

By this construction we have obtained the important map, *the wring operation*

$$\tau: G \times (\mathbf{H} \times \mathbf{C}) \rightarrow \mathbf{H} \times \mathbf{C},$$

where $\tau(\zeta, (a, b)) = (a_\zeta, b_\zeta)$.

Remark. For $\zeta = 1$ the map $l_1 = \text{id}$, therefore $\sigma_{1,P} = \sigma_0$, $v_{1,(a,b)} = \text{id}$ and $a_1 = a$, $b_1 = b$.

PROPOSITION 8.2. *Let $(a, b) \in \mathbf{H} \times \mathbf{C}$ and $P = P_{a,b}$. The Beltrami form $\mu_{\zeta,P}$ is analytic in ζ , and (a_ζ, b_ζ) is analytic in ζ .*

Proof. The analyticity of $\mu_{\zeta,P}$ follows from Lemmas 7.1 and 8.1, and the analyticity of (a_ζ, b_ζ) follows from Proposition 7.2. □

PROPOSITION 8.3. *If $(a, b) \in \mathbf{H} \times \mathbf{C}$ is given such that $P = P_{a,b} \in \mathcal{C}_d$, then $a_\zeta = a$ and $b_\zeta = b$ for all $\zeta \in G$.*

Proof. The result follows from Proposition 8.2 and the straightening theorem in [D-H3], which says

(a) every polynomial-like mapping $f: U' \rightarrow U$ of degree d is hybrid equivalent to a polynomial of degree d ,

(b) if K_f is connected, then the polynomial is unique up to conjugation by an affine map.

The set K_P is connected, since $P \in \mathcal{C}_d$. The polynomials $P_{\mathbf{a}_\zeta, b_\zeta}$ and $P_{\mathbf{a}, b}$ are quasi-conformally equivalent by the conjugating map $v_{\zeta, P}$, and $\tilde{\delta}v_{\zeta, P} = 0$ on K_P by construction, i.e. $P_{\mathbf{a}_\zeta, b_\zeta}$ is hybrid equivalent to $P_{\mathbf{a}, b}$. The only other polynomials in \mathcal{P}_d affine conjugated to $P_{\mathbf{a}, b}$ correspond to $\delta((a_{\nu(1)}, \dots, a_{\nu(d-1)}), b)$ in $\mathbf{H} \times \mathbf{C}$, where ν is a permutation of $1, 2, \dots, d-1$ and δ is a $(d-1)$ th root of unity. Therefore \mathbf{a}_ζ equals $\delta \mathbf{a}$ up to permutation and $b_\zeta = \delta b$. Since $(\mathbf{a}_1, b_1) = (\mathbf{a}, b)$, it follows from the analyticity of $(\mathbf{a}_\zeta, b_\zeta)$ that $(\mathbf{a}_\zeta, b_\zeta) = (\mathbf{a}, b)$ for all $\zeta \in G$. \square

We have now seen that the change in complex structure through l_ζ does not change a polynomial in the connectedness locus \mathcal{C}_d . It is quite a different matter with a polynomial outside \mathcal{C}_d , as we shall see in the following proposition. Notice how s corresponds to stretching and t to turning.

Recall that

$$\mathcal{Y}_r^j(\alpha) = \{(\mathbf{a}, b) \in \mathcal{S}_r^j \mid \varphi_{\mathbf{a}, b}(P_{\mathbf{a}, b}(a_j)) = r^d e^{i2\pi\alpha}\}.$$

Set

$$\mathcal{X}^j = \{(\mathbf{a}, b) \in \mathbf{H} \times \mathbf{C} - \mathcal{C}_d \mid h_{\mathbf{a}, b}(a_j) > \frac{1}{d} H(\mathbf{a}, b)\},$$

$$\mathcal{X}_r^j = \{(\mathbf{a}, b) \in \mathcal{X}^j \mid h_{\mathbf{a}, b}(a_j) = \log r\} \quad \text{and}$$

$$\mathcal{Y}_r^j(\alpha) = \{(\mathbf{a}, b) \in \mathcal{X}_r^j \mid \varphi_{\mathbf{a}, b}(P_{\mathbf{a}, b}(a_j)) = r^d e^{i2\pi\alpha}\}.$$

PROPOSITION 8.4. *Let (\mathbf{a}, b) be given such that $(\mathbf{a}, b) \in \mathcal{X}_r^j(\alpha)$ or $\mathcal{Y}_r^j(\alpha)$ respectively and let $\zeta = s + it \in G$. Then*

(1) $H(\mathbf{a}_\zeta, b_\zeta) = sH(\mathbf{a}, b)$.

(2) $(\mathbf{a}_\zeta, b_\zeta) \in \mathcal{X}_r^j(\alpha + \frac{1}{2\pi} t d \log r)$ or $\mathcal{Y}_r^j(\alpha + \frac{1}{2\pi} t d \log r)$ respectively.

(3) For a fixed $(\mathbf{a}, b) \in \mathbf{H} \times \mathbf{C} - \mathcal{C}_d$ the map $\zeta \mapsto (\mathbf{a}_\zeta, b_\zeta)$ is locally injective.

(4) For a fixed $(\mathbf{a}, b) \in \mathcal{X}_r^j(\alpha)$ the map

$$G \rightarrow \mathbf{C} - \bar{D} \quad \text{defined as} \quad \zeta \rightarrow \varphi_{\mathbf{a}_\zeta, b_\zeta}(P_{\mathbf{a}_\zeta, b_\zeta}(a_j, \zeta))$$

is a universal covering.

Proof. Let $P = P_{\mathbf{a}, b}$ and $P_\zeta = P_{\mathbf{a}_\zeta, b_\zeta}$. It follows from the proof of Proposition 8.2 that

$$\varphi_{P_\zeta} = l_\zeta \circ \varphi_P \circ v_{\zeta, P}^{-1}.$$

Let $z \in U_P$ and $\varphi_P(z) = e^{e+i\theta}$, then

$$\varphi_P(v_{\zeta, P}(z)) = l_\zeta(e^{e+i\theta}) = e^{se + i(t\theta + \theta)}.$$

Therefore

$$h_{\mathbf{a}_\zeta, b_\zeta}(v_{\zeta, P}(z)) = s h_{\mathbf{a}, b}(z) \quad \text{for all } z \in \mathbb{C},$$

and since

$$h_{\mathbf{a}, b}(a_j) > \frac{1}{d} h_{\mathbf{a}, b}(a_k)$$

it follows that

$$h_{\mathbf{a}_\zeta, b_\zeta}(a_{j, \zeta}) > \frac{1}{d} h_{\mathbf{a}_\zeta, b_\zeta}(a_{k, \zeta}).$$

With $\varphi_P(P(a)) = r^d e^{2\pi i a}$ we have especially that

$$\varphi_{P_\zeta}(P_{\mathbf{a}_\zeta, b_\zeta}(a_{j, \zeta})) = r^{sd} e^{i(t d \log r + 2\pi a)}.$$

The properties follow from the above expression for φ . \square

PROPOSITION 8.5. *The subset $\mathcal{X}^j(\alpha)$ of \mathcal{X}^j is a closed complex smooth hypersurface; in particular for $d=3$ it is a Riemann surface.*

Proof. The map $\psi^j: \mathcal{X}^j \rightarrow \mathbb{C} - \bar{D}$, $\psi^j(\mathbf{a}, b) = \varphi_{\mathbf{a}, b}(P_{\mathbf{a}, b}(a_j))$ is analytic and a submersion, since for each (\mathbf{a}, b) the map $G \rightarrow \mathbb{C} - \bar{D}$ in Proposition 8.4 (4) has non-vanishing derivative. The result follows from the implicit function theorem. \square

We shall now show another fundamental property for the wright operation $\tau: G \times (\mathbb{H} \times \mathbb{C}) \rightarrow \mathbb{H} \times \mathbb{C}$.

PROPOSITION 8.6. *The map τ is a group action, i.e. it satisfies*

$$\tau(\eta, (\tau(\zeta, (\mathbf{a}, b)))) = \tau(\eta * \zeta, (\mathbf{a}, b)).$$

Proof. This proposition really reflects the equality $l_\eta \circ l_\zeta = l_{\eta^*\zeta}$. In order to make the proof more transparent, we will think of polynomials as pairs (f, σ) , where $f: \bar{\mathbb{C}} \rightarrow \bar{\mathbb{C}}$ is a quasi-conformal mapping of degree d (typically a polynomial) with $f^{-1}(\infty) = \infty$, and σ is an f -invariant complex structure. To define an element of $\mathbf{H} \times \mathbf{C}$ in this way, we need in addition to label the critical points and to choose one of the φ -mappings. Of course, passing from this description to actual polynomials requires the measurable Riemann mapping theorem.

From this point of view, if P is a polynomial and φ_P the corresponding local coordinate near infinity, then

$$\tau(\zeta, P) = (P, \sigma_{\zeta, P}),$$

where $\sigma_{\zeta, P}$ is the complex structure $\varphi_P^*(\sigma_\zeta) = (l_\zeta \circ \varphi_P)^* \sigma_0$, extended by σ_0 to K_P . Note that $\varphi_{\tau(\zeta, P)} = l_\zeta \circ \varphi_P$ in this description. Now the proposition follows from the following chain of equalities:

$$\begin{aligned} \tau(\zeta, \tau(\eta, P)) &= \tau(\zeta, (P, \sigma_{\zeta, P})) = (P, (l_\zeta \circ \varphi_P)^* \sigma_\eta) = (P, (l_\eta \circ l_\zeta \circ \varphi_P)^* \sigma_0) \\ &= (P, (l_{\eta^*\zeta} \circ \varphi_P)^* \sigma_0) = (P, (\varphi_P^*(\sigma_{\eta^*\zeta}))), \end{aligned}$$

where we have omitted “extended by σ_0 ” in several places. \square

COROLLARY 8.7. *The following restrictions of the map $\tau: G \times (\mathbf{H} \times \mathbf{C}) \rightarrow \mathbf{H} \times \mathbf{C}$ are bijections:*

$$\begin{aligned} \tau: \{s+it\} \times \mathcal{X}_r^j(\alpha) &\rightarrow \mathcal{X}_r^j(\alpha + \frac{1}{2\pi} t d \log r) \\ \tau: \{s+it\} \times \mathcal{Y}_r^j(\alpha) &\rightarrow \mathcal{Y}_r^j(\alpha + \frac{1}{2\pi} t d \log r) \\ \tau: (0, \infty) \times \mathcal{S}_r &\rightarrow \mathbf{H} \times \mathbf{C} - \mathcal{C}_d \end{aligned}$$

for every $r > 1$, every $s+it \in G$, every $\alpha \in \mathbf{T} = \mathbf{R}/\mathbf{Z}$.

Proof. All the properties above follow from the fact τ is a group action, and that elements in a group have inverses. \square

We shall prove in Section 13 for cubic polynomials that $\mathcal{X}_r^j(\alpha)$ is analytically isomorphic to D and that $\mathcal{Y}_r^j(\alpha)$ is analytically isomorphic to 3 closed discs identified at one boundary point, a trefoil clover.

Section 9. Continuity on the structural stability set

Theorem 9.1 about continuity of the wring operation τ is the core of this paper. Up to now, everything works for polynomials of any degree ≥ 2 . In fact, the statement of Theorem 9.1 also makes sense in any degree; unfortunately, it is most likely false if $d > 3$. It is still quite possible that

$$H: \mathbf{H} \times \mathbf{C} - \mathcal{C}_d \rightarrow \mathbf{R}_+$$

is a fibration, but we do not know how to prove it.

THEOREM 9.1. *The map $\tau: G \times (\mathbf{C}^2 - \mathcal{C}_2) \rightarrow \mathbf{C}^2$ is continuous.*

Remark. The map $\tau: G \times \mathcal{C}_d \rightarrow \mathcal{C}_d$ is of course continuous, since it is just the second projection map. But it is most likely that the map $\tau: G \times \mathbf{C}^2 \rightarrow \mathbf{C}^2$ is not continuous. In [D-H3] there is an example of non-continuity for a family of cubic polynomials but in a different set up and with a different choice of complex structure.

The proof of Theorem 9.1 is inspired from [D-H3]. The proof is divided into two parts, following the Mañé-Sad-Sullivan decomposition of $\mathbf{H} \times \mathbf{C} - \mathcal{C}_d$. In [M-S-S] two decompositions of the parameter space are introduced. In [D-H3] the first decomposition is considered, while here the second one.

Let $\mathcal{R}_d \subset \mathbf{H} \times \mathbf{C} - \mathcal{C}_d$ denote the set of points $(\mathbf{a}_0, b_0) \in \mathbf{H} \times \mathbf{C} - \mathcal{C}_d$ for which $P_{\mathbf{a}_0, b_0}$ is structurally stable, i.e. the set of points (\mathbf{a}_0, b_0) for which there exists a neighborhood A in $\mathbf{H} \times \mathbf{C} - \mathcal{C}_d$ such that if $(\mathbf{a}, b) \in A$ then $P_{\mathbf{a}, b}$ and $P_{\mathbf{a}_0, b_0}$ are quasi-conformally equivalent.

In [M-S-S] and [S] it is shown that

(1) \mathcal{R}_d is open and dense in $\mathbf{H} \times \mathbf{C} - \mathcal{C}_d$.

(2) A neighborhood A and a family of quasi-conformal mappings $\omega_{\mathbf{a}, b}: \bar{\mathbf{C}} \rightarrow \bar{\mathbf{C}}$ can be chosen such that

(i) $\omega_{\mathbf{a}_0, b_0} = \text{id}$

(ii) $P_{\mathbf{a}, b} \circ \omega_{\mathbf{a}, b} = \omega_{\mathbf{a}, b} \circ P_{\mathbf{a}_0, b_0}$

(iii) $\omega_{\mathbf{a}, b}(z)$ is analytic in (\mathbf{a}, b) and quasi-conformal in z , with dilatation ratio bounded by a constant independent of $(\mathbf{a}, b) \in A$.

In the *first part* of the proof, which is the content of this section, we shall prove the continuity of τ at points $(\zeta(\mathbf{a}, b))$ where $(\mathbf{a}, b) \in \mathcal{R}_d$. This holds in any degree $d \geq 2$.

In the *second part* of the proof, which is the content of the next section, we shall restrict to *cubic* polynomials and assume that τ is not continuous at a point $(\zeta(a, b))$. We show that this implies that $(a, b) \in \mathcal{R}_3$, in contradiction with the first part.

First an easy observation about the set \mathcal{R}_d .

LEMMA 9.2. For any $(\mathbf{a}, b) \in \mathbf{H} \times \mathbf{C}$, where $a_i = a_j$ for some $i \neq j$, $(\mathbf{a}, b) \notin \mathcal{R}_d$.

Proof. For every $(\mathbf{a}, b) \in \mathbf{H} \times \mathbf{C} - \mathcal{C}_d$ with $a_i = a_j$ for some $i \neq j$ there are points (α, β) in $\mathbf{H} \times \mathbf{C} - \mathcal{C}_d$ arbitrary close to (\mathbf{a}, b) such that $\alpha_i \neq \alpha_j$ for every $i \neq j$. But no such polynomial $P_{\alpha, \beta}$ can be conjugated to $P_{\mathbf{a}, b}$. \square

In this section we will use part (c) of the Measurable Riemann Mapping Theorem. In order to emphasize the dependence on (\mathbf{a}, b) we shall in the following use the notation $v_{\zeta, (\mathbf{a}, b)} = v_{\zeta, P}$, $\mu_{\zeta, (\mathbf{a}, b)} = \mu_P(\zeta)$, $u_{\zeta, (\mathbf{a}, b)} = u_P(\zeta)$, where $P = P_{\mathbf{a}, b}$.

PROPOSITION 9.3. On the open set \mathcal{R}_d the Beltrami forms $\mu_{\zeta, (\mathbf{a}, b)}$ converge to $\mu_{\zeta_0, (\mathbf{a}_0, b_0)}$ in the L^1 -norm on any compact set as $(\zeta, (\mathbf{a}, b)) \rightarrow (\zeta_0, (\mathbf{a}_0, b_0))$.

Proof. The proof of Proposition 12 in [D-H3] can be copied. The inclusion relating the two M-S-S decompositions makes it actually easier for the second decomposition, which is the one considered here. \square

PROPOSITION 9.4. For every (\mathbf{a}, b) in the open set \mathcal{R}_d and for every $\zeta \in G$, $z \in \mathbf{C}$ the map $(\zeta, \mathbf{a}, b, z) \mapsto v_{\zeta, (\mathbf{a}, b)}(z)$ is continuous at $(\zeta, \mathbf{a}, b, z)$ and $(\mathbf{a}_\zeta, b_\zeta)$ depends continuously on $(\zeta, (\mathbf{a}, b))$.

Proof. Recall from Lemma 2 that

$$\|u_{\zeta_0, (\mathbf{a}, b)}\|_\infty = \left| \frac{\zeta_0 - 1}{\zeta_0 + 1} \right|.$$

Therefore to every bounded neighborhood $E \subset G$ of ζ_0 there is a K such that

$$\|u_{\zeta, (\mathbf{a}, b)}\|_\infty \leq K < 1$$

for all $(\zeta, (\mathbf{a}, b)) \in E \times \mathcal{R}_d$. Hence $w_{\mu_{\zeta, (\mathbf{a}, b)}}(z)$ depends continuously on $(\zeta, (\mathbf{a}, b))$ and z .

Proposition 9.4 follows now easily by copying the proof of Proposition 7.2 in case (ii). The case (i) is ruled out by Lemma 9.2. \square

This ends the proof of the first part of Theorem 9.1:

$$\tau: G \times \mathcal{R}_d \rightarrow \mathbb{C}^2 - \mathcal{C}_d$$

is continuous.

Section 10. Continuity for cubic polynomials

In this section we shall only consider cubic polynomials, and prove the second part of Theorem 9.1.

Assumptions and notation. Suppose τ is not continuous at $(\zeta_0, (a_0, b_0))$. Then there exists a sequence $(\zeta_n, (a_n, b_n))$ in $G \times (\mathbb{C}^2 - \mathcal{C}_3)$ converging to $(\zeta_0, (a_0, b_0))$, but such that $\tau(\zeta_n, (a_n, b_n))$ does not converge to $\tau(\zeta_0, (a_0, b_0))$.

Let $\sigma_n = \sigma_{\zeta_n}$, $P_n = P_{a_n, b_n}$, $\varphi_n = \varphi_{a_n, b_n}$, $K_n = K_{P_n}$, $v_n = v_{\zeta_n, P_n}$, $\mu_n = \mu_{\zeta_n, (a_n, b_n)}$ and let $P = P_{a_0, b_0}$, $\mu = \mu_{\zeta_0, (a_0, b_0)}$. Furthermore set $v_n \circ P_n \circ v_n^{-1} = Q_n = (P_n)_{\zeta_n}$.

The family (v_n) of quasi-conformal mappings has bounded dilatation ratio since $\zeta_n \rightarrow \zeta_0$. Therefore it is possible to extract a converging subsequence of (v_n) converging to $\bar{v} \neq v_{\zeta_0, (a_0, b_0)}$. Let the parameters for the induced polynomial $\bar{Q} = \bar{v} \circ P \circ \bar{v}^{-1}$ be denoted by (\bar{a}, \bar{b}) where $\bar{a} = \bar{v}(a)$. Then $(\bar{a}, \bar{b}) \neq \tau(\zeta_0, (a_0, b_0))$ by assumption. We may assume convergence for the original sequence, so $v_n \rightarrow \bar{v}$.

The steps in the proof. (1) The almost complex structure $\sigma_{\bar{\mu}} = \bar{v}^*(\sigma_0)$, corresponding to the Beltrami form $\bar{\mu}$, is P -invariant and $\sigma_{\bar{\mu}} = \varphi_P^*(\sigma_{\zeta_0})$ on U_P (Lemma 10.1). The Beltrami form $\bar{\mu}_1 = \bar{\mu} - \mu$ is therefore also P -invariant and $\sigma_{\bar{\mu}_1} = \sigma_0 = \varphi_P^*(\sigma_0)$ on U_P .

(2) The normalized analytic isomorphism $v_{\bar{\mu}_1}: (\bar{\mathbb{C}}, \sigma_{\bar{\mu}_1}) \rightarrow (\bar{\mathbb{C}}, \sigma_0)$ induces the polynomial $P_{\bar{\mu}_1}$ with parameters $(a_{\bar{\mu}_1}, b_{\bar{\mu}_1})$, where $a_{\bar{\mu}_1} = v_{\bar{\mu}_1}(a)$. The parameters $(a_{\bar{\mu}_1}, b_{\bar{\mu}_1})$ are different from (a_0, b_0) (Lemma 10.2).

(3) Each member in the two-parameter family of Beltrami forms $\nu(\zeta, n) = \mu_P(\zeta) + \eta \bar{\mu}_1$ is P -invariant and $\sigma_{\nu(\zeta, \eta)} = \varphi_P^*(\sigma_{\zeta})$ on U_P . The normalized analytic isomorphism

$$\nu_{(\zeta, \eta), P}: (\bar{\mathbb{C}}, \sigma_{\nu(\zeta, \eta)}) \rightarrow (\bar{\mathbb{C}}, \sigma_0)$$

induces the polynomial $P_{(\zeta, \eta)}$. The set of parameters for the polynomials $P_{(\zeta, \eta)}$ contains a neighborhood A of (a_0, b_0) in $\mathbb{C}^2 - \mathcal{C}_3$. For each $(\alpha, \beta) \in A$ the polynomial $P_{\alpha, \beta}$ is by construction quasi-conformally equivalent to P_{a_0, b_0} (Lemma 10.3), i.e. $(a_0, b_0) \in \mathcal{R}_3$.

LEMMA 10.1. *The complex structure $\sigma_{\bar{\mu}} = \bar{v}^*(\sigma_0)$ is P -invariant, and $\sigma_{\bar{\mu}} = \varphi_P^*(\sigma_{\zeta_0})$ on U_P . The map $\bar{v}: (\bar{\mathbb{C}}, \sigma_{\bar{\mu}}) \rightarrow (\bar{\mathbb{C}}, \sigma_0)$ is the normalized analytic isomorphism.*

Proof. We shall prove that $\bar{v}: (\bar{\mathbb{C}}, \sigma_{\bar{\mu}}) \rightarrow (\bar{\mathbb{C}}, \sigma_0)$ satisfies (1), (2), (3) in Proposition 6.1 with $l = l_{\zeta_0}$.

Since $v_n(\infty) = \infty$, we have $\bar{v}(\infty) = \infty$. The polynomial $\bar{Q} = \lim Q_n$ is monic and has no term of degree 2, i.e. \bar{Q} is a polynomial in \mathcal{P}_3 . From the commutative diagram

$$\begin{array}{ccc} (\bar{\mathbb{C}}, \sigma_{\bar{\mu}}) & \xrightarrow{P} & (\bar{\mathbb{C}}, \sigma_{\bar{\mu}}) \\ \bar{v} \downarrow & & \downarrow \bar{v} \\ (\bar{\mathbb{C}}, \sigma_0) & \xrightarrow{\bar{Q}} & (\bar{\mathbb{C}}, \sigma_0) \end{array}$$

it follows that the complex structure $\sigma_{\bar{\mu}}$ is P -invariant: at any point $z \in \mathbb{C} - \cup P^{-n}(\Omega_\infty)$ we have

$$\begin{aligned} P^*(\sigma_{\bar{\mu}}(P(z))) &= (\bar{v}^{-1} \circ \bar{Q} \circ \bar{v})^* [\bar{v}^*(\bar{v}(P(z)))] \\ &= \bar{v}^* \circ \bar{Q}^* [\sigma_0(\bar{Q}(\bar{v}(z)))] = \bar{v}^*(\sigma_0(\bar{v}(z))) = \sigma_{\bar{\mu}}(z). \end{aligned}$$

On $\mathbb{C} - \bar{D}$ we have that σ_n converges to σ_{ζ_0} . Since φ_n converges to φ_P uniformly on every compact subset of U_P we have that $\mu_n = \varphi_n^*(\sigma_n)$ converges to $\mu = \varphi_P^*(\sigma_{\zeta_0})$ on U_P . From this and from $\mathbb{C} - K_P \subset \lim_{n \rightarrow \infty} (\mathbb{C} - K_n)$ it follows that μ_n converges to μ uniformly on every compact subset of $\mathbb{C} - (K_P \cup \cup P^{-n}(\Omega_\infty))$.

Furthermore $\mu = \bar{\mu}$ on $\mathbb{C} - (K_P \cup \cup P^{-n}(\Omega_\infty))$, since $\sigma_{\mu_n} = v_n^*(\sigma_0)$ converges uniformly to $\sigma_{\bar{\mu}} = \bar{v}^*(\sigma_0)$ on every compact subset of $\mathbb{C} - (K_P \cup \cup P^{-n}(\Omega_\infty))$. Hence $\sigma_{\bar{\mu}} = \varphi_P^*(\sigma_{\zeta_0})$ on U_P .

The map $l_{\zeta_n} \circ \varphi_P \circ v_n^{-1}$ converges uniformly to $l_{\zeta_0} \circ \varphi_P \circ \bar{v}^{-1}$ on every compact subset of U_P , hence the map $l_{\zeta_0} \circ \varphi_P \circ \bar{v}^{-1}$ is tangent to the identity at ∞ . \square

From the remark after the proof of Proposition 6.1 it follows that for P_{ξ_0} and $\tilde{\mu}$ given as above, the map $\tilde{v}: (\tilde{C}, \sigma_{\tilde{\mu}}) \rightarrow (\tilde{C}, \sigma_0)$ is unique.

Let $\mu = u(z)d\bar{z}/dz$ and $\tilde{\mu} = \tilde{u}(z)d\bar{z}/dz$. Then

$$\tilde{u}(z) - u(z) = \begin{cases} 0 & \text{on } C - (K_P \cup \cup P^{-n}(\Omega_\infty)) \\ u(z) & \text{on } K_P \end{cases}$$

The form $\tilde{\mu}_1 = [\tilde{u}(z) - u(z)]d\bar{z}/dz$ is a P -invariant Beltrami form with bounded dilatation ratio. Once again we shall use the remark at the end of Section 6. Since $\sigma_{\tilde{\mu}_1} = \sigma_0 = \varphi_P^*(\sigma_0)$ on U_P , the complex structure is not changed at all on U_P , so that it corresponds to l being the identity on $C - \bar{D}$. No matter what $\tilde{\mu}_1$ is on K_P , there exists a unique analytic isomorphism $v_{\tilde{\mu}_1}: (\tilde{C}, \sigma_{\tilde{\mu}_1}) \rightarrow (\tilde{C}, \sigma_0)$ satisfying (1), (2), (3). Let

$$P_{\tilde{\mu}_1} = v_{\tilde{\mu}_1} \circ P \circ v_{\tilde{\mu}_1}^{-1}.$$

Notice that

$$\varphi_P = \varphi_P \circ v_{\tilde{\mu}_1}^{-1}$$

on $v_{\tilde{\mu}_1}(U_P)$, and let $(a_{\tilde{\mu}_1}, b_{\tilde{\mu}_1})$ be the parameters for $P_{\tilde{\mu}_1}$, where $a_{\tilde{\mu}_1} = v_{\tilde{\mu}_1}(a)$.

LEMMA 10.2. $(a_{\tilde{\mu}_1}, b_{\tilde{\mu}_1}) \neq (a_0, b_0)$.

Proof. Assume $(a_{\tilde{\mu}_1}, b_{\tilde{\mu}_1}) = (a_0, b_0)$. We shall show that this implies $(\tilde{a}, \tilde{b}) = \tau(\xi_0, (a_0, b_0))$, in contradiction with the assumption.

If $(a_{\tilde{\mu}_1}, b_{\tilde{\mu}_1}) = (a_0, b_0)$, then $P_{\tilde{\mu}_1} = P$ and the quasi-conformal mapping $v_{\tilde{\mu}_1}$ satisfies $P = v_{\tilde{\mu}_1} \circ P \circ v_{\tilde{\mu}_1}^{-1}$ and $\sigma_{\tilde{\mu}_1} = v_{\tilde{\mu}_1}^*(\sigma_0)$ by definition. At any point in $\tilde{C} - (K_P \cup \cup P^{-n}(\Omega_\infty))$ we have that $\sigma_{\tilde{\mu}_1} = \sigma_0 = v_{\tilde{\mu}_1}^*(\sigma_0)$ such that $v_{\tilde{\mu}_1}$ restricted to $\tilde{C} - (K_P \cup \cup P^{-n}(\Omega_\infty))$ is analytic with respect to the standard complex structure. Furthermore $\varphi_P = \varphi_P \circ v_{\tilde{\mu}_1}^{-1}$ in a neighborhood of ∞ . Therefore $v_{\tilde{\mu}_1}$ is the identity in that neighborhood of ∞ , hence the identity on $C - K_P$.

It is now clear that $v_{\tilde{\mu}_1}: (\tilde{C}, \sigma_{\tilde{\mu}_1}) \rightarrow (\tilde{C}, \sigma_\mu)$ is analytic: on $C - K_P$ the map $v_{\tilde{\mu}_1}$ is the identity and $\tilde{\mu} = \mu$, and $\tilde{\mu}$ equals $\tilde{\mu}_1$ on K_P . Look at the following commutative diagram

$$\begin{array}{ccc}
(\bar{C}, \bar{\sigma}_{\bar{\mu}}) & \xrightarrow{P} & (\bar{C}, \bar{\sigma}_{\bar{\mu}}) \\
v_{\bar{\mu}_1} \downarrow & & \downarrow v_{\bar{\mu}_1} \\
(\bar{C}, \sigma_{\bar{\mu}}) & \xrightarrow{P} & (\bar{C}, \sigma_{\bar{\mu}}) \\
v_{\zeta_0} \downarrow & & \downarrow v_{\zeta_0} \\
(\bar{C}, \sigma_0) & \xrightarrow{P_{\zeta_0}} & (\bar{C}, \sigma_0)
\end{array}$$

The map $v_{\zeta_0} \circ v_{\bar{\mu}_1}: (\bar{C}, \sigma_{\bar{\mu}}) \rightarrow (\bar{C}, \sigma_0)$ is an analytic isomorphism and it fulfills the normalizing conditions (1), (2) and (3) with $l=l_{\zeta_0}$. Therefore $v_{\zeta_0} \circ v_{\bar{\mu}_1} = \bar{v}$ and $\bar{a} = \bar{v}(a) = v_{\zeta_0}(a_0)$. Hence $(\bar{a}, \bar{b}) = \tau(\zeta_0(a_0, b_0))$. \square

Let $\nu(\zeta, \eta) = \mu(\zeta) + \eta \bar{\mu}_1$ with $\zeta \in G$ and $\eta \in D_{1/\|\bar{\mu}_1\|_\infty}$. Let $\nu(\zeta, \eta) = u(\zeta, \eta) dz/dz$ as Beltrami form. It means that

$$u(\zeta, \eta)(z) = \begin{cases} u(\zeta)(z) & \text{on } \mathbf{C} - (K_P \cup \mathbf{U}P^{-n}(\Omega_\infty)) \\ \eta \bar{u}(z) & \text{on } K_P \end{cases}$$

The Beltrami form $\nu(\zeta, \eta)$ is obviously P -invariant. The dilatation ratio for $\nu(\zeta, \eta)$ is bounded by the maximum of $|(\zeta-1)/(\zeta+1)|$ and $|\eta| \|\bar{\mu}_1\|_\infty$. For each (ζ, η) let $v_{(\zeta, \eta), P}$ denote the normalized analytic isomorphism $v_{(\zeta, \eta), P}: (\bar{C}, \sigma_{\nu(\zeta, \eta)}) \rightarrow (\bar{C}, \sigma_0)$, and let $P_{(\zeta, \eta)}$ denote the induced polynomial $v_{(\zeta, \eta), P} \circ P \circ v_{(\zeta, \eta), P}^{-1}$. Let $(a_{(\zeta, \eta)}, b_{(\zeta, \eta)})$ be the parameters for $P_{(\zeta, \eta)}$ with $a_{(\zeta, \eta)} = v_{(\zeta, \eta), P}(a)$. Then $(a_0, b_0) = (a_{(1,0)}, b_{(1,0)})$ and $(a_{\bar{\mu}_1}, b_{\bar{\mu}_1}) = (a_{(1,1)}, b_{(1,1)})$. The family of Beltrami forms $\nu(\zeta, \eta)$ is analytic in (ζ, η) , since $u(\zeta, \eta)(z)$ is analytic in (ζ, η) for all $z \in \mathbf{C} - \mathbf{U}P^{-n}(\Omega_\infty)$. From Proposition 7.2 and the remark after that it follows, that $v_{(\zeta, \eta), P}(z_0)$ is analytic in (ζ, η) for all z_0 and that $a_{(\zeta, \eta)}, b_{(\zeta, \eta)}$ are analytic in (ζ, η) . Furthermore it follows from Proposition 8.4 that the map $(\zeta, \eta_0) \mapsto (a_{(\zeta, \eta_0)}, b_{(\zeta, \eta_0)})$ for each fixed η_0 is locally injective. It follows from Lemma 10.2 that the map $(1, \eta) \mapsto (a_{(1, \eta)}, b_{(1, \eta)})$ is non-constant, since it is analytic in η and the values differ for $\eta=0$ and $\eta=1$. With these properties it follows (see Lemma 10.3), that the map is open at $(1, 0)$, i.e. all polynomials near P are quasi-conformally conjugate to P .

LEMMA 10.3. *If $f: (\mathbf{C}^2, (0, 0)) \rightarrow (\mathbf{C}^2, (0, 0))$ is an analytic map with $f(0, 0) = (0, 0)$, $f(\mathbf{C} \times \{0\}) \subset (\mathbf{C} \times \{0\})$, $f(\{0\} \times \mathbf{C}) \subset (\{0\} \times \mathbf{C})$, and if the restriction to one coordinate axis is injective and the restriction to the other is non-constant, then f is open at $(0, 0)$.*

Proof. Denote $(0, 0) = \mathbf{0}$. The hypothesis implies that $\mathbf{0}$ is an isolated point of $f^{-1}(\mathbf{0})$. If we take a small sphere surrounding $\mathbf{0}$ and consider its image under f , we may assume that the image does not contain $\mathbf{0}$ and hence has an enclosing number. This number must be positive, and the neighborhood of $\mathbf{0}$ where it is positive is in the image. \square

This ends the proof of Theorem 9.1. \square

Remark. One could, in degrees higher than 3, hope for a theorem similar to Theorem 9.1 about continuity outside the locus of polynomials with connected Julia set. However there are two places in the proof of Theorem 9.1, where it is essential that the degree $d=3$:

(1) In degree 3 we never have to consider points $(\zeta, (a, b))$ where $P_{a,b} \in \partial\mathcal{C}_3$, where in degree $d>3$ we would have to consider polynomials in $\mathbf{H} \times \mathbf{C} - \mathcal{C}_d$ which have a polynomial-like restriction equivalent to a polynomial in $\partial\mathcal{C}_3$.

(2) We use one variable ζ to vary the complex structure *outside* K_p and another variable η to vary the complex structure *inside* K_p , i.e. the number of variables equals the dimension of \mathcal{P}_3 .

Chapter III. The global topology of the parameter space

Introduction

In this chapter we will collect all the threads from the earlier parts of the paper. The mapping τ provides a section of H , showing that H is a trivial fibration. For large r we have shown that the fibers are spheres, so they all are. This result will be crucial in Section 13, because it will allow us to use a theorem of Alexander's that says that if a torus is nicely embedded in S^3 , one side at least is unknotted. Using this result, we can understand the topology of the dynamically defined Riemann surfaces of equation

$$\psi^\pm(a, b) = \text{constant};$$

where $\psi^\pm(a, b) = \varphi_{a,b}(P_{a,b}(\pm a))$ (cf. Section 8, Proposition 8.5).

Of course these equations are quite transcendental, and the curves they define are a priori mysterious.

For cubic polynomials we shall use

$$(+a, -a) = (a_1, a_2),$$

and similarly $\mathcal{S}_r^\pm, \mathcal{X}_r^\pm, \mathcal{Y}_r^\pm, \mathcal{Q}_r^\pm(a)$ for \mathcal{S}_r^j , etc.

Section 11. Fibrations

THEOREM 11.1. *The map $H: \mathbf{C}^2 - \mathcal{C}_3 \rightarrow (0, \infty)$ is a trivial fibration and each fiber $H^{-1}(r) = \mathcal{S}_r$ is homeomorphic to the 3-dimensional sphere S^3 .*

CONJECTURE. *The map $H: \mathbf{H} \times \mathbf{C} - \mathcal{C}_d \rightarrow (0, \infty)$ is a trivial fibration for any $d \geq 2$.*

Proof. Let $r > 1$ be chosen arbitrarily. Let $T_r: (0, \infty) \times \mathcal{S}_r \rightarrow \mathbf{C}^2 - \mathcal{C}_3$ be the map $T_r(u, (a, b)) = \tau(u/\log r, (a, b))$. Then the following diagram commutes

$$\begin{array}{ccc} (0, \infty) \times \mathcal{S}_r & \xrightarrow{T_r} & \mathbf{C}^2 - \mathcal{C}_3 \\ \pi_1 \searrow & & \swarrow H \\ & (0, \infty) & \end{array}$$

where π_1 is the projection onto the first factor. The map T_r is a bijection (Corollary 8.7), it is continuous (Theorem 9.1) and the inverse map T_r^{-1} is also continuous since for any $(a, b) \in \mathbf{C}^2 - \mathcal{C}_3$ we have $T_r^{-1}(a, b) = (H(a, b), \tau(\log r/H(a, b), (a, b)))$. Therefore T_r is a trivialization for each r .

It follows from Theorem 5.7 that \mathcal{S}_r is homeomorphic to S^3 for r sufficiently large, hence for all $r > 1$. \square

COROLLARY 11.2. *The connectedness locus \mathcal{C}_3 is cell-like; in particular \mathcal{C}_3 is contractible.*

Proof. Each of the spheres \mathcal{S}_r is collared, since it is one fiber of a fibration. Thus each bounds a ball by the Schoenflies theorem [Br]. Therefore the connectedness locus is a nested intersection of balls. \square

Remark. The proof of Theorem 11.1 works for quadratic polynomials as well and gives another proof of part of Theorem 2.1: *The map $H: \mathbf{C} - M \rightarrow (0, \infty)$ is a trivial fibration and each fiber $H^{-1}(r) = \mathcal{S}_r$ is homeomorphic to S^1 .*

Let $r > 1$ be given. Let $\psi^\pm: \mathcal{X}^\pm \rightarrow \mathbf{C} - \bar{D}$ be the map defined by $\psi^\pm(a, b) = \varphi_P(P(\pm a))$, where $P = P_{a, b}$, and let $\psi_r^\pm: \mathcal{S}_r^\pm \rightarrow S^1$ be the map defined by

$$\psi_r^\pm(a, b) = \frac{\psi^\pm(a, b)}{|\psi^\pm(a, b)|}$$

PROPOSITION 11.3. *The maps $\psi^\pm: \mathcal{X}^\pm \rightarrow \mathbf{C}-\bar{D}$ and $\psi_r^\pm: \mathcal{S}_r^\pm \rightarrow S^1$ are locally trivial topological fibrations.*

Proof. We will only give the argument for ψ^+ . Consider the pullback $(\text{exp})^* \mathcal{X}^+$ to the universal covering space $\text{exp}: G \rightarrow \mathbf{C}-\bar{D}$, giving a commutative diagram

$$\begin{array}{ccc} (\text{exp})^* \mathcal{X}^+ & \longrightarrow & \mathcal{X}^+ \\ \downarrow & \text{exp} & \downarrow \\ G & \longrightarrow & \mathbf{C}-\bar{D} \end{array}$$

Using exactly the same argument as in Theorem 11.1, we see that

$$(\text{exp})^* \mathcal{X}^+ \rightarrow G$$

is a trivial fibration, and hence that

$$\mathcal{X}^+ \rightarrow \mathbf{C}-\bar{D}$$

is locally trivial. □

In Section 13 we shall show that each fiber $\mathcal{X}_r^\pm(a)$ in the fibration $\psi_r^\pm: \mathcal{S}_r^\pm \rightarrow S^1$ is homeomorphic to a disc and that each fiber $\mathcal{Y}_r^\pm(a)$ in the fibration $\psi^\pm: \mathcal{S}_r^\pm \rightarrow S^1$ is homeomorphic to three closed discs with one boundary point in common, a trefoil clover.

Section 12. The structure of the fiber (Part 1)

It is not so easy to prove that the fiber $\mathcal{X}_r^+(a)$ in the fibration $\psi^+: \mathcal{X}^+ \rightarrow \mathbf{C}-\bar{D}$ is homeomorphic to a disc. The proof we give requires some heavy machinery from topology, given in the next section, together with the results of this section.

Let \mathcal{X}_r^+ be the biggest subset of \mathcal{X}_r^+ consisting of values (a, b) so that the φ map is defined on both critical values. More specifically, let

$$\mathcal{X}_r^+ = \{(a, b) \in \mathcal{X}_r^+ \mid \frac{1}{3} \log r < h_{a,b}(-a) < 3 \log r\},$$

and

$$\mathcal{X}_r^+(\alpha) = \mathcal{X}_r^+ \cap \mathcal{X}_r^+(\alpha).$$

The restriction of the fibration $\psi_r^+ : \mathcal{X}_r^+ \rightarrow S^1$ to \mathcal{X}_r^+ is of course a fibration, since the trivializing map T_r in the proof of Theorem 11.1 only involves turning without stretching so that the level of $h_{a,b}(-a)$ is maintained. Thus to understand the topology of the fibers we can restrict our attention to $\mathcal{X}_r^+(0)$ and with a large r if necessary.

Let $A = \{z \in \mathbb{C} \mid r < |z| < r^9\}$, and let us denote

$$F: \mathcal{X}_r^+(0) \rightarrow A$$

the mapping

$$\psi^-((a, b)) = \varphi_{a,b}(P_{a,b}(-a))$$

restricted to $\mathcal{X}_r^+(0)$; then F is analytic.

LEMMA 12.1. *The map F is proper, hence $\mathcal{X}_r^+(0)$ is a finite ramified covering space of A .*

Proof. The subsets

$$\{z \in \mathbb{C} \mid c_1^3 \leq |z| \leq c_2^3\}$$

of A with $\frac{1}{3} \log r < \log c_1 < \log r < \log c_2 < 3 \log r$ exhaust A by compact sets, so it is enough to prove that their inverse images are compact. Clearly the inverse image is

$$\{(a, b) \in \mathcal{X}_r^+(0) \mid \log c_1 \leq h_{a,b}(-a) \leq \log c_2\}$$

which is compact. □

So the question becomes: what finite ramified cover is it? In order to answer this question, we need a bit of notation.

First, let us denote σ_1 and σ_2 the segments of the real axis

$$\sigma_1 = \{z \mid r < z < r^3\} \quad \text{and} \quad \sigma_2 = \{z \mid r^3 < z < r^9\}.$$

Define

$$w: \pi_1(A - \{r^3\}) \rightarrow \mathbf{Z}/3$$

to be the mapping which takes a loop in $A - \{r^3\}$ and gives the class mod 3 of the winding number of the loop around r^3 . Since $\mathbf{Z}/3$ is abelian, we do not need to worry about base points.

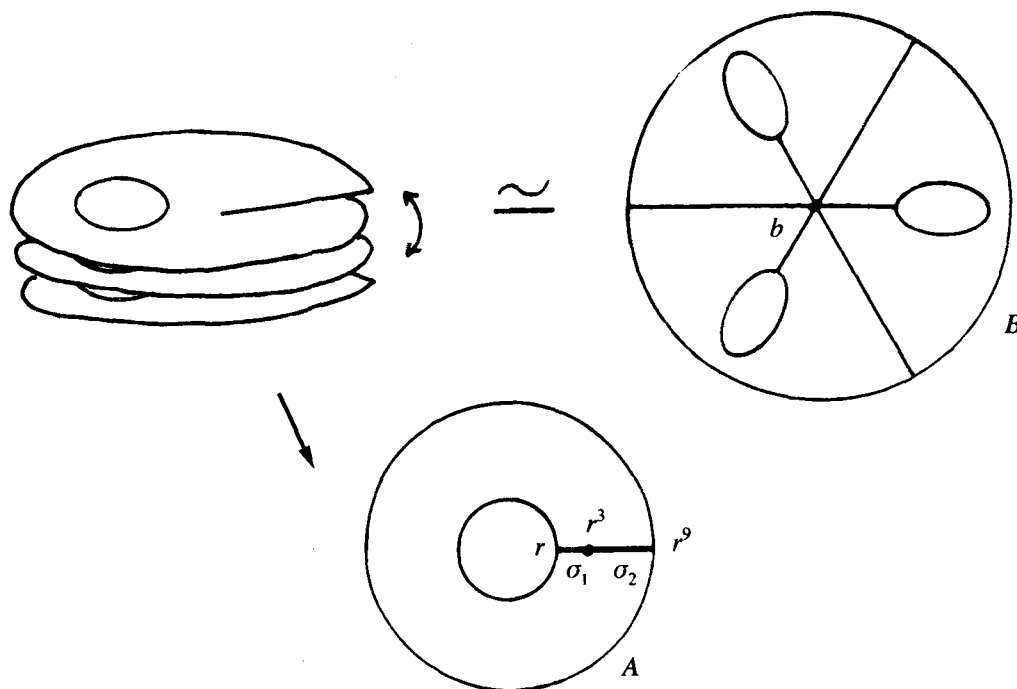

Fig. 12.1

Let $B \rightarrow A$ be the ramified covering space corresponding to the kernel of w , and let $\mathbf{b} \in B$ be the unique point above r^3 ; see Figure 12.1.

THEOREM 12.2. *The map $F: \mathcal{X}_r^+(0) \rightarrow A$ lifts to an isomorphism $\tilde{F}: \mathcal{X}_r^+(0) \rightarrow B$.*

Proof. The proof will require 2 lemmas and 2 propositions. We will show that \tilde{F} exists (Proposition 12.4 and 12.5) and that it is of degree 1 (Lemma 12.3 and 12.6 and Proposition 12.5). Since an analytic map proper of degree 1 between Riemann surfaces is an isomorphism, this proves the result.

LEMMA 12.3. *The set $F^{-1}(r^3)$ consists of a single point z . This point is on the complex line of equation $a=0$, and $\mathcal{X}_r^+(0)$ is transverse to the line at z .*

Proof. At any point (a, b) of $F^{-1}(r^3)$, we have

$$\varphi_{a,b}(P_{a,b}(+a)) = \varphi_{a,b}(P_{a,b}(-a)) = r^3.$$

In particular, $P_{a,b}(+a) = P_{a,b}(-a)$, so it follows from Proposition 2.3 that $a=0$. But for the polynomials of the form z^3+b , there is a ‘‘Mandelbrot set’’ M_3 and it follows from Theorem 2.1 that the value of the corresponding φ -map at the critical value specifies the polynomial uniquely if it is not in M_3 .

In fact, the proof goes by showing that $b \mapsto \varphi_{0,b}(b)$ is an isomorphism $\mathbb{C} - M_3 \rightarrow \mathbb{C} - \bar{D}$, in particular the derivative does not vanish. This proves the desired transversality. \square

PROPOSITION 12.4. *The mapping $F: \mathcal{X}_r^+(0) - \{z\} \rightarrow A - \{r^3\}$ lifts to a proper mapping $\tilde{F}: \mathcal{X}_r^+(0) - \{z\} \rightarrow B - \{b\}$.*

Proof. This is an application of the homotopy lifting criterion: we need to show that

$$w \circ F_*: \pi_1(\mathcal{X}_r^+(0) - \{z\}) \rightarrow \mathbb{Z}/3$$

is the zero-map, i.e. that if γ is any loop on $\mathcal{X}_r^+(0) - \{z\}$, then $F(\gamma)$ winds around r^3 a number of times which is divisible by 3.

Step 1. Suppose $(a, b) \in \mathcal{X}_r^+(0) - \{z\}$ satisfies $F(a, b) \in A - (\sigma_1 \cup \sigma_2)$. We define a function $\text{cl}(a, b) \in \mathbb{Z}/3$ as follows:

Let β be the angle of the exterior ray passing through $P(-a)$ and let β_1 be the angle of the exterior ray landing on $+2a$. This is one of the thirds of β and since $F(a, b)$ is not real and positive then β_1 lies in one of the sectors $(0, 1/3)$, $(1/3, 2/3)$ or $(2/3, 1)$. Define $\text{cl}(a, b)$ according to which sector it belongs to.

Step 2. Let $I=[0,1]$ and $\delta: I \rightarrow \mathcal{X}_r^+(0) - \{z\}$ be a path such that $F \circ \delta$ crosses σ_1 exactly once transversally, and does not cross σ_2 . Then $\text{cl}(\delta(0)) = \text{cl}(\delta(1))$.

This is best seen from looking at the 3 pictures in Figure 12.2, representing the dynamical plane just before the intersection, at the moment of intersection, and just after the intersection. There are two other analogous sets of pictures, depending on which thirds of 0 meet at $+a$, or equivalently which lift of σ_1 is being crossed. We leave to the reader the care of drawing them.

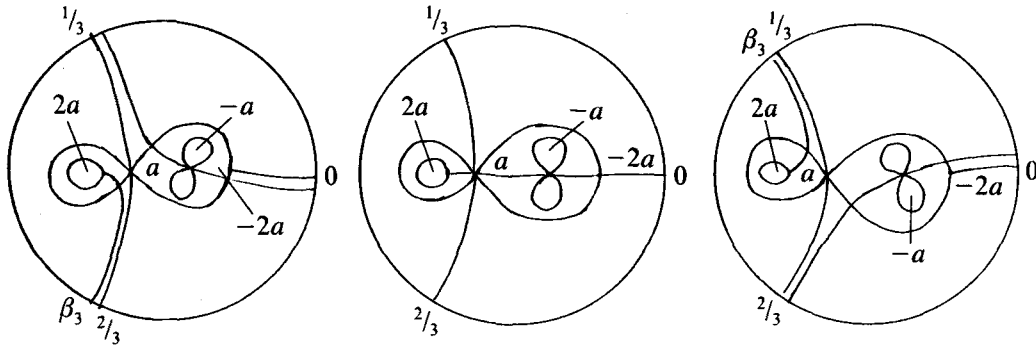

Fig. 12.2

Step 3. Let $I=[0,1]$ and $\delta: I \rightarrow \mathcal{X}_r^+(0) - \{z\}$ be a path such that $f \circ \delta$ crosses σ_2 exactly once transversally in the positive direction, and does not cross σ_1 . Then $cl(\delta(1)) = cl(\delta(0)) + 1$.

Again this is best seen from looking at the 3 pictures in Figure 12.3. As above, there are two other analogous sets of pictures, left to the reader.

Now the result of Lemma 12.4 is straightforward. Any element of $\pi_1(\mathcal{X}_r^+(0) - \{z\})$ can be represented by a smooth loop whose image under F intersects the positive real axis transversally. Since the class at the beginning of the loop must be the same as at the end, the algebraic number of intersections of $F(\gamma)$ with σ_2 must be divisible by 3.

The map \hat{F} is proper since the subsets in B above the subsets of A

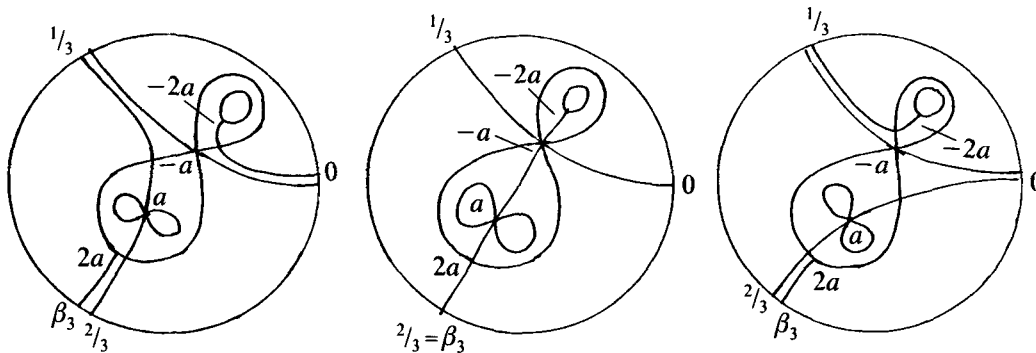

Fig. 12.3

$$\{z \in \mathbb{C} \mid c_1^3 \leq |z| \leq c_2^3\}$$

exhaust B by compact sets. □

PROPOSITION 12.5. *The mapping $\tilde{F}: \mathcal{X}_r^+(0) - \{z\} \rightarrow B - \{b\}$ extends analytically to a mapping $\tilde{F}: \mathcal{X}_r^+(0) \rightarrow B$ of degree 1.*

Proof. Step 1. The mapping $\tilde{F}: \mathcal{X}_r^+(0) - \{z\} \rightarrow B - \{b\}$ extends continuously to $\tilde{F}: \mathcal{X}_r^+(0) \rightarrow B$ since (a_n, b_n) converges to $z = (0, b_0)$ then $F(a_n, b_n)$ converges to r^3 and therefore $\tilde{F}(a_n, b_n)$ converges to b . Hence \tilde{F} has a removable singularity at z .

The degree can be computed at any point and for any value of $r > 1$; we will of course choose the point z . Proposition 12.5 follows if we can prove that $\tilde{F}_r^+(0) \rightarrow A$ has local degree 3 at z for r sufficiently large. The degree 3 follows from the assertions in step 2 and 3:

Step 2. If (a, b) follows a small loop going around z once in $\mathcal{X}_r^+(0)$ then $P_{a,b}(-a)$ turns 3 times around $P_{a,b}(+a)$.

This follows from the transversality in Lemma 12.3, since the number above will be the same for any loop on a curve transverse to the line $a=0$. For the curve $b=b_0$, where $z=(0, b_0)$

$$P_{a,b_0}(-a) = 2a^3 + b_0 \quad \text{and} \quad P_{a,b_0}(+a) = -2a^3 + b_0,$$

so the winding number above is 3 in that case.

Step 3. Along the same loop as above, $\varphi_{a,b}(P_{a,b}(-a))$ turns 3 times around $\varphi_{a,b}(P_{a,b}(+a)) = r^3$.

This is because $\varphi_{a,b}$ is a homeomorphism close to the identity for r sufficiently large. A proof will follow from the purely topological Lemma 12.6. In order to state the lemma we need some notation:

Let $D \subset \mathbb{C}$ be a disc, and let $\Phi = \{\varphi_t\}_{t \in [0,1]}$ be a family of injective mappings $\varphi_t: D \rightarrow \mathbb{C}$ depending continuously to $t \in [0,1]$ with $\varphi_0 = \varphi_1$. Then we can define $\deg \Phi = \text{ind}(\varphi_t(x) - \varphi_t(y))$ where ind measures the winding number around 0, and $x, y \in D$ are any distinct points. Clearly $\deg \Phi$ does not depend on the choice of x and y .

LEMMA 12.6. *If $x(t), y(t)$ are points of D with $x(t) \neq y(t)$ for all $t \in (0, 1]$ and $x(0) = x(1), y(0) = y(1)$, then*

$$\text{ind}(\varphi_t(x(t)) - \varphi_t(y(t))) = \text{deg } \Phi + \text{ind}(x(t) - y(t)).$$

Proof. Consider

$$\Psi: [0, 1] \times [0, 1] \rightarrow \mathbb{C} - \{0\} \quad \text{with} \quad \Psi(s, t) = \varphi_t(x(s)) - \varphi_t(y(s));$$

then Ψ is a continuous mapping with $\Psi(0, 0) = \Psi(0, 1) = \Psi(1, 1)$. The winding number of Ψ restricted to the diagonal is the same as the winding number of Ψ restricted to $\{0\} \times [0, 1] \cup [0, 1] \times \{1\}$, but the first is $\text{ind}(\varphi_t(x(t)) - \varphi_t(y(t)))$ and the second is $\text{deg } \Phi + \text{ind}(x(t) - y(t))$. This ends the proof of Lemma 12.6. \square

In our case choose r large enough so that $|b_0| > 12r$. It follows from Lemma 5.2 that $\varphi_{a,b}$ is defined for all z such that $|z| \geq 12r$. Choose a disc D around b_0 and satisfying $|z| \geq 12r$ for $z \in D$. If the loop $t \rightarrow (a(t), b(t))$ around $(0, b_0)$ in $\mathcal{X}_r^+(0)$ is chosen sufficiently small so points

$$x(t) = P_{(a(t), b(t))}(-a(t)) \quad \text{and} \quad y(t) = P_{(a(t), b(t))}(+a(t))$$

will be in D , and $\varphi_t = \varphi_{(a(t), b(t))}$ then step 3 follows.

Clearly if the local degree of F is 3, then the local degree of \tilde{F} is 1, finally proving Proposition 12.5. \square

Consider the map

$$h^-: \mathcal{X}_r^+ \rightarrow (\frac{1}{3} \log r, 3 \log r) \quad \text{with} \quad h^-(a, b) = h_{a,b}(-a).$$

Note that the restriction of ψ_r^+ to

$$\{(a, b) \in \mathcal{X}_r^+ \mid h^-(a, b) = \log s\}$$

is a fibration over a circle, since the trivialization map T_r in the proof of Theorem 11.1, as mentioned earlier, maintains the level of $h_{a,b}(-a)$. Using Theorem 12.1 we know the fibers for different values of s ; let the circles $|z| = s^4$ in A be oriented counterclockwise and give their inverse images in \mathcal{X}_r^+ the induced orientation. Then we have the following corollary of Theorem 12.2:

COROLLARY 12.7. *The level curve for $h^-: \mathcal{X}_r^+(0) \rightarrow (\frac{1}{3} \log r, 3 \log r)$ at level $\log s$ is one oriented simple closed curve, three oriented simple closed curves with one point in common (the boundary of a trefoil clover leaf) or three oriented simple closed curves if s is less than, equal to or greater than r respectively.*

PROPOSITION 12.8. *The level surface $\{(a, b) \in \mathcal{X}_r^+ | h^-(a, b) = \log s\}$ is homeomorphic to a torus for $s \neq r$ in $(r^{1/3}, r^3)$.*

Proof. If $\log r < \log s < 3 \log r$, the set above is a torus, since it is a bundle of oriented circles over a circle.

Of course the same is true if $\frac{1}{3} \log r < \log s < \log r$ by exchanging the role of $+a$ and $-a$. □

Remark. The mapping Ψ^- restricted to $\{(a, b) \in \mathcal{X}_r^+ | h^-(a, b) = \log s\}$ with $\frac{1}{3} \log r < \log s < \log r$ is a fibration over a circle, with fiber three oriented circles. Proposition 12.8 says that this is a non-trivial fibration; the three circles permute circularly when followed around the base.

PROPOSITION 12.9. (a) *The mapping $\psi_r^+: \mathcal{S}_r^+ \cap \mathcal{S}_r^- \rightarrow S^1$ is a bundle of boundaries of clover leaves; its monodromy is a circular permutation.*

(b) *The mapping $p = (\psi_r^+, \psi_r^-): \mathcal{S}_r^+ \cap \mathcal{S}_r^- \rightarrow S^1 \times S^1$ is a triple covering of the torus $S^1 \times S^1$ ramified along the diagonal Δ .*

Beware that ramified is used in a non standard way, since $\Delta \subset S^1 \times S^1$ is a curve, not a point, so that this triple cover has a circle covering Δ once, along which six surfaces meet, see Figure 12.4.

Proof. For part (a), we have seen all but the monodromy. The mapping

$$\psi_r^+: \mathcal{X}_r^+ \rightarrow S^1$$

is a bundle of discs with 3 holes, and we have seen that the monodromy permutes the holes circularly. Since the lobes of the clover leaves each surround one hole, they must permute as the holes do.

(b) By Corollary 12.7 the fiber of $\psi_r^+: \mathcal{S}_r^+ \cap \mathcal{S}_r^- \rightarrow S^1$ above a consists of 3 circles

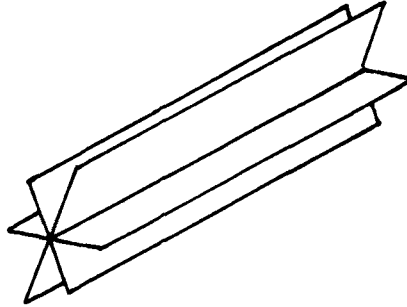

Fig. 12.4

joined at a point z_α . The mapping ψ_r^- restricts to such a fiber by mapping each circle homeomorphically to S^1 and $\psi_r^-(z_\alpha) = \alpha$. Thus $p^{-1}(\alpha, \beta)$ consists of 3 points above any point $(\alpha, \beta) \in S^1 \times S^1$ with $\alpha \neq \beta$ and of one point z_α if $\alpha = \beta$.

The fact that $p: \mathcal{S}_r^+ \cap \mathcal{S}_r^- - p^{-1}(\Delta) \rightarrow S^1 \times S^1 - \Delta$ is a covering map follows from the fact that the restrictions of ψ_r^+ and ψ_r^- to $\mathcal{S}_r^+ \cap \mathcal{S}_r^- - p^{-1}(\Delta)$ are fibrations with transverse fibers. □

Section 13. The structure of the fiber (Part 2)

In this section we shall prove that the fibers of the fibration

$$\psi^+: \mathcal{X}^+ \rightarrow \mathbf{C} - \bar{D}$$

are homeomorphic to discs, and that the fibers of the fibration

$$\psi_r^+: \mathcal{S}_r^+ \rightarrow S^1$$

are homeomorphic to 3 closed discs with one boundary point in common, a trefoil clover leaf.

First we shall prove that a certain subset $\tilde{\mathcal{S}}_r$ of $\mathbf{C}^2 - \mathcal{E}_3$ is homeomorphic to S^3 for r sufficiently large.

The function H is defined symmetrically with respect to $+a$ and $-a$. In order to use Proposition 12.7 we shall define a function similar to H , but not symmetrical in $+a$ and $-a$. Let

$$\tilde{H}(a, b) = \sup \{h_{a,b}(+a), h_{a,b}(-a) - \log 2\}.$$

The constant $\log 2$ is not essential, any constant different from 0 would do.

For $r < 1$ set

$$\begin{aligned} \mathcal{F}_r &= \{(a, b) \in \mathbb{C}^2 - \mathcal{C}_3 \mid \tilde{H}(a, b) = \log r\}, \\ \mathcal{F}_r^+ &= \{(a, b) \in \mathcal{F}_r \mid h_{a,b}(+a) = \log r\} \quad \text{and} \\ \mathcal{F}_r^- &= \{(a, b) \in \mathcal{F}_r \mid h_{a,b}(-a) = \log 2r\}. \end{aligned}$$

Note that $\mathcal{F}_r^+ \subset \mathcal{F}_r^+$ if $r > \sqrt{2}$, that $\mathcal{F}_r^- \subset \mathcal{F}_{2r}^-$ and that

$$\mathcal{F}_r \subset \{(a, b) \in \mathbb{C}^2 - \mathcal{C}_3 \mid \log r \leq H(a, b) \leq \log 2r\}.$$

It follows from Proposition 12.8 that $\mathcal{F}_r^+ \cap \mathcal{F}_r^-$ is a torus.

PROPOSITION 13.1. *There exists an r_0 such that $\mathcal{F}_r \simeq S^3$ for any $r \geq r_0$.*

The proof follows the same lines as the proof of Theorem 5.6. The following 2 Lemmas are similar to Proposition 5.1 and 5.5.

LEMMA 13.1. *For each $(a, b) \neq (0, 0)$ the function $\tilde{H}(\gamma_{a,b}(t))$ is increasing in t for t sufficiently large.*

LEMMA 13.2. *There exists a t_0 such that for all $(a, b) \in \mathcal{F}_r$ with $r \geq 11$ the function $\tilde{H}(\gamma_{a,b}(t))$ is increasing in t for all $t \geq t_0$.*

For $r \geq r_0$ we therefore have a torus $\mathcal{F}_r^+ \cap \mathcal{F}_r^-$ embedded in a 3-sphere \mathcal{F}_r . This is exactly the situation dealt with in a theorem by J. W. Alexander, for a proof see [A1]. Nowadays one can give an easier proof using the loop theorem.

THEOREM. *If $f: T \rightarrow S^3$ is a differentiable embedding, then $S^3 - f(T)$ has two connected components, and at least one of them is homeomorphic to a solid torus.*

Consider the fibrations

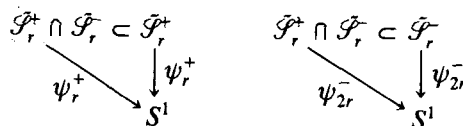

The first one is defined for $r > \sqrt{2}$.

THEOREM 13.2. *Both \mathcal{F}_r^+ and \mathcal{F}_r^- are homeomorphic to a solid torus. Each fiber in the fibration $\psi_r^+ : \mathcal{F}_r^+ \rightarrow S^1$ is homeomorphic to a closed disc, and each fiber in the fibration $\psi_{2r}^- : \mathcal{F}_r^- \rightarrow S^1$ is homeomorphic to three closed discs. Each fiber in the fibrations $\psi^\pm : \mathcal{X}^\pm \rightarrow \mathbf{C} - \bar{D}$ is homeomorphic to an open disc.*

Proof. Let $r \geq r_0$. It is sufficient to prove the theorem for $r \geq r_0$, since $\psi^\pm : \mathcal{X}^\pm \rightarrow \mathbf{C} - \bar{D}$ are fibrations.

Let $F_r^+ = (\psi_r^+)^{-1}(1)$ and $F_{2r}^- = (\psi_{2r}^-)^{-1}(1)$ denote the fibers over 1 in the fibrations $\psi_r^+ : \mathcal{F}_r^+ \rightarrow S^1$, $\psi_{2r}^- : \mathcal{F}_r^- \rightarrow S^1$ respectively. Choose a base point $x_0 \in F_r^+ \cap F_{2r}^-$.

Assume that \mathcal{F}_r^+ is homeomorphic to a solid torus. Then apply the long exact homotopy-sequence to the fibration $\psi_r^+ : \mathcal{F}_r^+ \rightarrow S^1$

$$\begin{array}{ccccccc} \dots & \rightarrow & \pi_2(S^1, 1) & \rightarrow & \pi_1(F_r^+, x_0) & \rightarrow & \pi_1(\mathcal{F}_r^+, x_0) \xrightarrow{(\psi_r^+)_*} \pi_1(S^1, 1) \rightarrow \pi_0(F_r^+, x_0) \rightarrow \dots \\ & & \wr \downarrow & & \wr \downarrow & & \wr \downarrow \\ & & \{0\} & & \mathbf{Z} & & \mathbf{Z} \end{array}$$

using that $(\psi_r^+)_*$ is an isomorphism, we get $\pi_1(F_r^+, x_0) = \{0\}$. Therefore F_r^+ is a contractible compact surface with boundary, i.e. homeomorphic to a closed disc. Then $\mathcal{X}_r^+(0)$ and any $\mathcal{X}_\alpha^+(a)$ is homeomorphic to an open disc. By symmetry any $\mathcal{X}_\alpha^-(a)$ is homeomorphic to a disc, in particular $\mathcal{X}_{2r}^-(0)$. As a consequence F_{2r}^- is homeomorphic to 3 closed discs and \mathcal{F}_r^- is homeomorphic to a solid torus.

Assume that \mathcal{F}_r^- is homeomorphic to a solid torus. Then apply the long exact homotopy-sequence to the fibration $\psi_{2r}^- : \mathcal{F}_r^- \rightarrow S^1$

$$\begin{array}{ccccccc} \rightarrow & \pi_2(S^1, 1) & \rightarrow & \pi_1(F_{2r}^-, x_0) & \rightarrow & \pi_1(\mathcal{F}_r^-, x_0) \xrightarrow{(\psi_{2r}^-)_*} \pi_1(S^1, 1) & \rightarrow & \pi_0(F_{2r}^-, x_0) & \rightarrow & \pi_0(\mathcal{F}_r^-, x_0) \\ & \wr \downarrow & & \wr \downarrow & & \wr \downarrow & & \wr \downarrow & & \wr \downarrow \\ & \{0\} & & \mathbf{Z} & & \mathbf{Z} & & \mathbf{Z} & & \{0\} \end{array}$$

using that $(\psi_{2r}^-)_*$ maps a generator in $\pi_1(\mathcal{F}_r^-, x_0)$ to 3 times a generator in $\pi_1(S^1, 1)$, we get $\pi_1(F_{2r}^-, x_0) = \{0\}$ and $\pi_0(F_{2r}^-, x_0) \cong \mathbf{Z}/3\mathbf{Z}$. Therefore F_{2r}^- is a surface with boundary with 3 contractible compact components, i.e. homeomorphic to 3 closed discs. Then $\mathcal{X}_{2r}^-(0)$ is homeomorphic to a disc and so is any $\mathcal{X}_\alpha^-(a)$ and $\mathcal{X}_\alpha^+(a)$. As a consequence F_r^+ is homeomorphic to a closed disc and \mathcal{F}_r^+ is homeomorphic to a solid torus. \square

Remark. We have finally discovered the structure of the inner part of \mathcal{X}_r^+ . The important steps in the proof were:

- (1) $\tilde{\mathcal{S}}_r$ is a sphere for r large, the culminating result of the first 5 sections;
- (2) The continuity of the wring, showing that the structure is independent of r .
- (3) The structure of \mathcal{X}_r^+ contained in Theorem 12.2.
- (4) Alexander's theorem which says that the two pieces of information above suffice.

One of our main results now follows as a corollary of Theorem 13.2 and Proposition 12.9.

COROLLARY 13.3. *Each fiber in the fibration $\psi_r^+ : \mathcal{S}_r^+ \rightarrow S^1$ is homeomorphic to three closed discs with one boundary point in common, a trefoil clover leaf. The total space \mathcal{S}_r^+ is homeomorphic to the unique triple cover of the solid torus $S^1 \times \bar{D}$ ramified along the diagonal Δ in $S^1 \times S^1$.*

COROLLARY 13.4. *The map $(\psi_r^+, \psi_r^-) : \mathcal{S}_r^+ \cap \mathcal{S}_r^- \rightarrow S^1 \times S^1$ is the unique triple cover ramified over the diagonal Δ .*

Remark. It might be possible to prove that $\mathcal{X}_r^+(0)$ is homeomorphic to a disc and that $\mathcal{Y}_r^+(0)$ is homeomorphic to a trefoil clover without using Alexander's theorem.

From Corollary 4.2 we know that

$$|\varphi_P(P(+a)) - P(+a)| \leq \frac{3}{r} \quad \text{for } P = P_{a,b} \quad \text{and } (a, b) \in \mathcal{S}_r^+.$$

Therefore for r large we get a good approximation for the set $\mathcal{Y}_r^+(0)$ by

$$\{a \in \mathbb{C} \mid |4a^3 + r^3| \leq r^3\}$$

and a good approximation for the set $\mathcal{X}_r^+(0)$ by

$$\{a \in \mathbb{C} \mid |4a^3 + r^3| \leq r^9\}.$$

The sets so defined are homeomorphic to a trefoil clover and an open disc respectively. One might hope that a transversality argument could be used to prove that the sets are homeomorphic to $\mathcal{Y}_r^+(0)$ and $\mathcal{X}_r^+(0)$ respectively for r large.

For sure this approach can be used to produce computer pictures which simulate what happens inside the clover leaves. The internal structure in the clover leaves is obtained from the fourth decomposition of the parameter space, and it is the content of the second paper in this series.

Section 14. The global topology of the parameter space

Our final theorems describe the topological structure of the triple $(\mathcal{S}_r; \mathcal{S}_r^+, \mathcal{S}_r^-)$ together with some quotients of $(\mathcal{S}_r; \mathcal{S}_r^+, \mathcal{S}_r^-)$.

Let

$$S^3 = \{(z_1, z_2) \in \mathbf{C}^2 \mid |z_1|^2 + |z_2|^2 = 1\}$$

be decomposed into the union of the two solid tori E_i , where

$$E_i = \{(z_1, z_2) \in S^3 \mid |z_i|^2 \leq \frac{1}{2}\}.$$

Let $T = E_1 \cap E_2$. The diagonal Δ_T in T is an unknotted circle in S^3 , so $\pi_1(S^3 - \Delta_T) \cong \mathbf{Z}$. Let \tilde{S}^3 be the ramified covering space of S^3 corresponding to the kernel of the canonical projection $\mathbf{Z} \rightarrow \mathbf{Z}/3$. Since Δ_T has codimension 2 in S^3 , the covering space is a 3-dimensional manifold, in fact \tilde{S}^3 is homeomorphic to S^3 . Let \tilde{E}_i be the inverse image in \tilde{S}^3 of E_i . The mapping $E_i \rightarrow S^1 \times \tilde{D}$ given by

$$(z_1, z_2) \mapsto \left(\frac{z_j}{|z_j|}, \sqrt{2} z_i \right) \quad \text{where } j \neq i$$

is a homeomorphism, so \tilde{E}_i is homeomorphic to a triple cover of $S^1 \times \tilde{D}$ ramified along the diagonal Δ in $S^1 \times S^1$.

THEOREM 14.1. *The triple $(\mathcal{S}_r; \mathcal{S}_r^+, \mathcal{S}_r^-)$ is homeomorphic to the triple cover of $(S^3; E_1, E_2)$ ramified along Δ_T in $T = E_1 \cap E_2$.*

Proof. Let $\pi: \tilde{S}^3 \rightarrow S^3$ be the triple cover ramified along Δ_T , and $\tilde{T} = \pi^{-1}(T)$ and $\tilde{\Delta}_T = \pi^{-1}(\Delta_T)$. The mapping $\tilde{T} \rightarrow S^1 \times S^1$ given by

$$x \mapsto \left(\frac{\pi(X)_1}{|\pi(X)_1|}, \frac{\pi(X)_2}{|\pi(X)_2|} \right)$$

is a triple cover ramified over the diagonal, in fact the only one (up to covering transformations) such that $\tilde{T} - \tilde{\Delta}_T$ is connected. The same is true of the mapping

$$(\psi_r^+, \psi_r^-): \mathcal{S}_r^+ \cap \mathcal{S}_r^- \rightarrow S^1 \times S^1,$$

by Corollary 13.4. So there exists a homeomorphism $F: \mathcal{S}_r^+ \cap \mathcal{S}_r^- \rightarrow \tilde{T}$ which commutes with the projections onto $S^1 \times S^1$.

Now the mapping $\tilde{E}_1 \rightarrow S^1$ given by

$$x \mapsto \frac{\pi(X)_2}{|\pi(X)_2|}$$

is a fibration with a clover leaf as fiber, just as is $\psi_r^+: \mathcal{S}_r^+ \rightarrow S^1$. So Theorem 14.1 follows from the following lemma:

LEMMA 14.2. *Let B be any topological space, and $X \rightarrow B, Y \rightarrow B$ any two locally trivial fibrations over B with fibers clover leaves. Then any homeomorphism $f: \partial X \rightarrow \partial Y$ making the diagram*

$$\begin{array}{ccc} \partial X & \xrightarrow{f} & \partial Y \\ & \searrow & \swarrow \\ & B & \end{array}$$

commute extends to a homeomorphism $\tilde{f}: X \rightarrow Y$ making the diagram

$$\begin{array}{ccc} X & \xrightarrow{\tilde{f}} & Y \\ & \searrow & \swarrow \\ & B & \end{array}$$

commute.

Proof. This is a standard result from algebraic topology. The obstruction to extending f is an element of $H^1(B)$ with coefficients in the sheaf of homeomorphisms of the fiber which are the identity on the boundary. But this group is contractible. Clearly it is the product of three copies of the corresponding group for the disc, and the group of homeomorphisms of the disc which extend the identity on the boundary is contractible, as can be seen for instance using the Alexander trick. \square

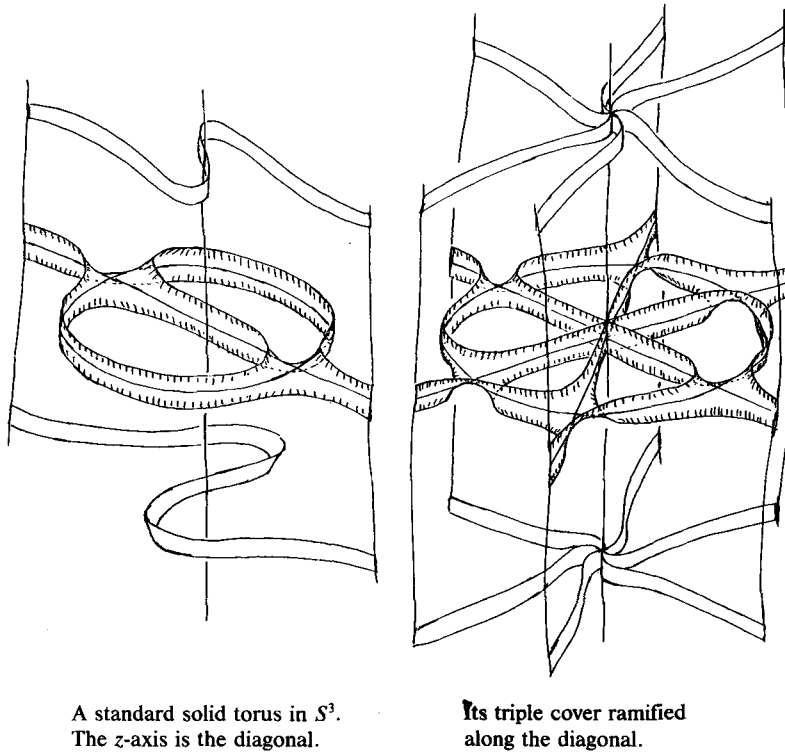

Fig. 14.1

Figure 14.1 is a drawing first of a torus embedded in S^3 , viewed as the one point compactification of \mathbb{R}^3 , so that its diagonal is the z-axis. Next to it is a drawing of the three-fold covering ramified along the z-axis, which is then easy to imagine.

Theorem 14.1 is not quite satisfying. Indeed \mathcal{S} , has a “dynamically defined” group Γ of automorphisms, isomorphic to $\mathbb{Z}/2 \times \mathbb{Z}/2$. We wish to find an action of the same group on \tilde{S}^3 , and an equivariant homeomorphism. This will allow us to understand the topology of quotients of \mathcal{S} , by subgroups of Γ by studying the corresponding quotients of \tilde{S}^3 .

Remark. The covering transformations of \tilde{S}^3 , on the other hand, do not seem to have a dynamic interpretation.

Automorphisms of \mathcal{S} . The group of automorphism Γ referred to above is formed of

$$\text{id}: (a, b) \mapsto (a, b)$$

$$\gamma_1: (a, b) \mapsto (-a, b)$$

$$\gamma_2: (a, b) \mapsto (a, -b)$$

$$\gamma_3: (a, b) \mapsto (-a, -b)$$

Observe that the γ_i do indeed map \mathcal{S}_r to itself, and are “dynamically defined”, in the following sense. Recall that a point of \mathbf{C}^2 can be thought of as a cubic polynomial with the critical points labeled $+a$ and $-a$, and a choice of a φ -map at infinity. Then γ_1 consists of reversing the labeling of the critical points, and γ_2 of choosing the other φ -map. Since $\gamma_3 = \gamma_1 \circ \gamma_2$, this gives a dynamic interpretation to γ_3 also.

Next, notice γ_1 and γ_2 map \mathcal{S}_r^+ to \mathcal{S}_r^- . This is clear for γ_1 and for γ_2 we see it as follows: the polynomials $P_{a,b}$ and $P_{a,-b}$ both have critical points at $\pm a$, and they are conjugated by $z \mapsto -z$. Thus $+a$ plays the same role for $P_{a,b}$ as $-a$ plays for $P_{a,-b}$, in particular if $+a$ escapes fastest for $P_{a,b}$ then $-a$ escapes fastest for $P_{a,-b}$. In particular, γ_3 maps each \mathcal{S}_r^\pm to itself.

Construction of the topological model. Consider the group G isomorphic to $\mathbf{Z}/2 \times \mathbf{Z}/2$ consisting of the following involutions of S^3

$$\text{id}: (z_1, z_2) \mapsto (z_1, z_2)$$

$$g_1: (z_1, z_2) \mapsto (z_2, z_1)$$

$$g_2: (z_1, z_2) \mapsto (-z_2, -z_1)$$

$$g_3: (z_1, z_2) \mapsto (-z_1, -z_2).$$

The involutions g_1 and g_2 map E_1 into E_2 .

PROPOSITION 14.3. *There exist unique liftings of $(\text{id}, g_1, g_2, g_3)$ to maps $(\text{id}, \tilde{g}_1, \tilde{g}_2, \tilde{g}_3)$ of the 3-fold ramified covering space \tilde{S}^3 of S^3 ramified along Δ_T , with $\tilde{G} = \{\text{id}, \tilde{g}_1, \tilde{g}_2, \tilde{g}_3\}$ forming a group still isomorphic to $\mathbf{Z}/2 \times \mathbf{Z}/2$.*

Proof. The existence of liftings follows immediately from the homotopy lifting criterion, since all the g_i restrict to homeomorphisms of $S^3 - \Delta$ homotopic to the

identity. In fact, each of the g_i has three lifts, which differ by composition with a covering transformation.

We will show that one of these lifts is an involution by considering the action on the anti-diagonal $\Theta = \{(z_1, z_2) | z_1 = -z_2\}$. The space Θ is a circle, parametrized for instance by the argument of z_1 , and each of the g_i maps Θ to itself, by the following maps:

$g_1|_{\Theta}$ is multiplication by -1 ,

$g_2|_{\Theta}$ is the identity, i.e. multiplication by 1 ,

$g_3|_{\Theta}$ is multiplication by -1 .

The inverse image $\tilde{\Theta}$ of Θ in \tilde{S}^3 is a circle which covers Θ three times, so the three lifts of g_1 and g_3 are multiplications by the cube roots of -1 , whereas the three lifts of g_2 are multiplication by the three cube roots of 1 . Choose the cube root -1 in the first two cases, and 1 for the other; this specifies \tilde{g}_i . Now each \tilde{g}_i^2 is a covering transformation, since it covers $\tilde{g}_i^2 = \text{id}$, and it is the identity on $\tilde{\Gamma}$, hence it is the identity; similarly $\tilde{g}_1 \circ \tilde{g}_2 = \tilde{g}_2 \circ \tilde{g}_1 = \tilde{g}_3$.

This proves existence of the lifts; uniqueness follows from the facts that for each of the cube roots above, only one was a square root of 1 . □

Construction of an equivariant homeomorphism.

THEOREM 14.4. *There exists a homeomorphism of \mathcal{S}_r with \tilde{S}^3 which conjugates the group Γ of automorphisms of \mathcal{S}_r to the group \tilde{G} above.*

Proof. As usual, it is easier to construct conjugacies when things are mapped to something else than when they are mapped to themselves. We will therefore begin by considering γ_3 .

Let $\tilde{\mathcal{S}}_r^+$ be the quotient of \mathcal{S}_r^+ by the group $\{\text{id}, \gamma_3\}$, and \tilde{E}_1 be the quotient of \tilde{E}_1 by $\{\text{id}, g_3\}$. The homeomorphism

$$F: \mathcal{S}_r^+ \cap \mathcal{S}_r^- \rightarrow \tilde{T}$$

induces a homeomorphism \tilde{F} from the boundary of $\tilde{\mathcal{S}}_r^+$ onto the boundary of \tilde{E}_1 .

LEMMA 14.5. *The homeomorphism above extends to a homeomorphism*

$$\mathcal{S}_r^+ \rightarrow \tilde{E}_1.$$

Proof. First, observe that $\varphi_{a,-b}(z) = -\varphi_{a,b}(-z)$. If $(a, b) \in \mathcal{S}_r^+$, so that $+a$ escapes faster than $-a$ for $P_{a,b}$ and $-a$ escapes faster than $+a$ for $P_{-a,-b}$, we have that

$$\varphi_{-a,-b}(P_{-a,-b}(-a)) = -\varphi_{a,b}(P_{a,b}(+a)).$$

Since ψ_r^+ fibers \mathcal{S}_r^+ over the circle, with fiber a clover leaf, the formula above means that the diagram

$$\begin{array}{ccc} \mathcal{S}_r^+ & \xrightarrow{\gamma_3} & \mathcal{S}_r^+ \\ \psi_r^+ \downarrow & & \downarrow \psi_r^+ \\ S^1 & \xrightarrow{z \mapsto -z} & S^1 \end{array}$$

commutes. Therefore the square $(\psi_r^+)^2$ fibers $\tilde{\mathcal{S}}_r^+$ over a circle, with fiber a clover leaf. In the same way $(z_2/|z_2|)^2$ fibers \tilde{E}_1 over the circle. The result now follows from Lemma 14.2. □

Proof of Theorem 14.4. Choose a homeomorphism \tilde{F} as in Lemma 14.3, and lift it to the homeomorphism $F: \mathcal{S}_r^+ \rightarrow \tilde{E}_1$ extending the given F on the boundary. Now map \mathcal{S}_r^- to \tilde{E}_2 by

$$(a, b) \mapsto g_1(F(-a, b)), \tag{1}$$

and denote this mapping still by F ; it is continuous since it coincides with the original F on $\mathcal{S}_r^+ \cap \mathcal{S}_r^-$.

This F has the two following properties by construction:

$$\begin{aligned} g_1 \circ F &= F \circ \gamma_1 && \text{on } \mathcal{S}_r^- \\ g_3 \circ F &= F \circ \gamma_3 && \text{on } \mathcal{S}_r^+. \end{aligned}$$

Everything required follows from these properties. Indeed, if $(a, b) \in \mathcal{S}_r^+$, then $\gamma_1(a, b) \in \mathcal{S}_r^-$ and

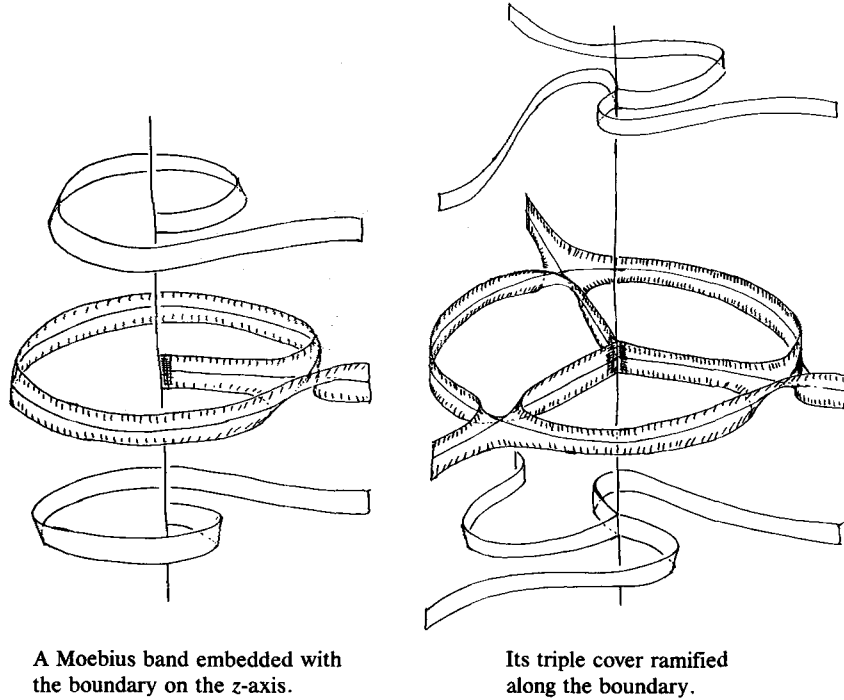

Fig. 14.2

$$F \circ \gamma_1(a, b) = g_1 \circ F \circ \gamma_1 \circ \gamma_1(a, b) = g_1 \circ F(a, b).$$

Thus $F \circ \gamma_1 = g_1 \circ F$ on \mathcal{S}_r . Next, on \mathcal{S}_r^- ,

$$F \circ \gamma_3 = g_1 \circ F \circ \gamma_1 \circ \gamma_3 = g_1 \circ F \circ \gamma_3 \circ \gamma_1 = g_1 \circ g_3 \circ F \circ \gamma_1 = g_3 \circ g_1 \circ F \circ \gamma_1 = g_3 \circ F,$$

so that $F \circ \gamma_3 = g_3 \circ F$ everywhere. Finally, since

$$\gamma_2 = \gamma_1 \circ \gamma_3 \quad \text{and} \quad g_2 = g_1 \circ g_3,$$

we have $F \circ \gamma_2 = g_2 \circ F$. □

Since for the following results it is enough to study the topological model, in which everything is explicit and elementary, we will not give proofs. However, we will give drawings which should help the reader visualize the objects described.

COROLLARY 14.6. *The quotient of \mathcal{S}_r by the group $\{\text{id}, \gamma_1\}$ is homeomorphic to a 3-sphere. The image of $\mathcal{S}_r^+ \cap \mathcal{S}_r^-$ in the quotient is homeomorphic to the triple cover of a standard Moebius band ramified along its boundary (see Figure 14.2).*

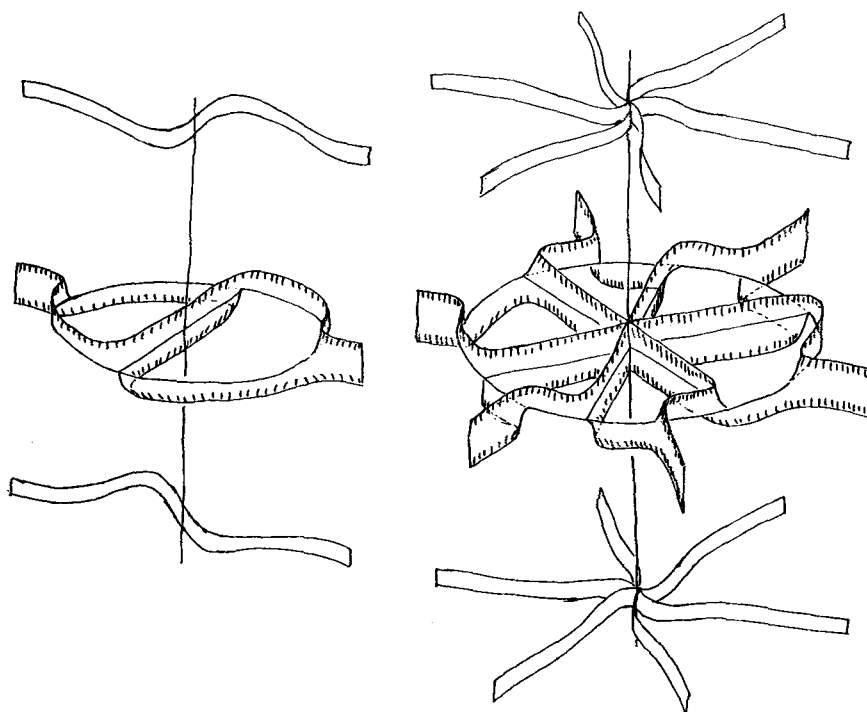

A Moebius band with central circle the z-axis.

Its triple cover ramified along the central circle.

Fig. 14.3

Remark. The quotient of \mathcal{S} by $\{\text{id}, \gamma_1\}$ is just the level surface of H for polynomials written in the form $z^3 + c_1 z + c_0$. The complement of the image of $\mathcal{S}_r^+ \cap \mathcal{S}_r^-$ is an open solid torus knotted in S^3 . It is the torus knot $V(2, 3)$, the trefoil knot (!) made so fat as to fill almost all of S^3 .

COROLLARY 14.7. *The quotient of \mathcal{S} by the group $\{\text{id}, \gamma_2\}$ is homeomorphic to a 3-sphere. The image of $\mathcal{S}_r^+ \cap \mathcal{S}_r^-$ in the quotient is homeomorphic to the triple cover of a standard Moebius band ramified along the circle running along its center (see Figure 14.3).*

COROLLARY 14.8. *The quotient of \mathcal{S} by the group $\{\text{id}, \gamma_3\}$ is homeomorphic to the 3-dimensional real projective space \mathbf{P}^3 .*

COROLLARY 14.9. *The quotient of \mathcal{S} by the group Γ is homeomorphic to a 3-sphere. The image of $\mathcal{S}_r^+ \cap \mathcal{S}_r^-$ in the quotient is the triple cover of an unknotted annulus*

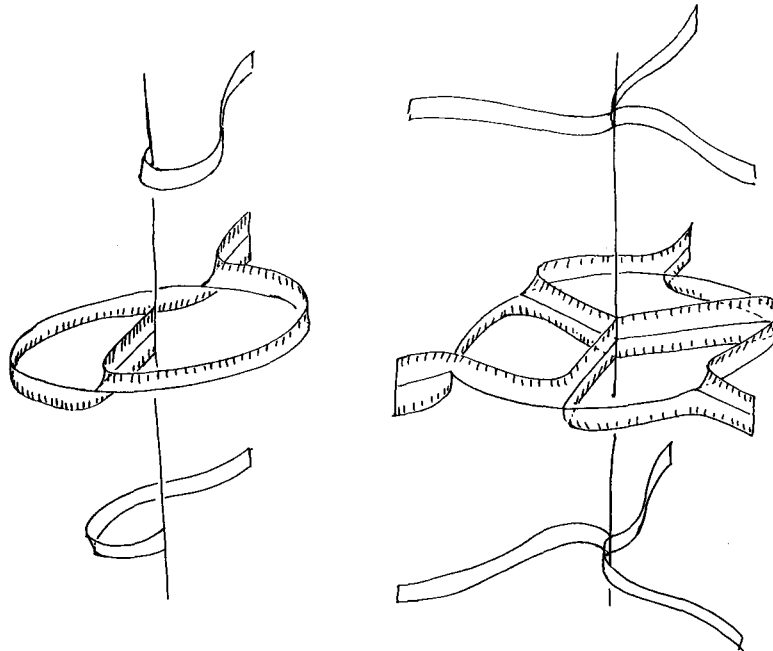

An annulus with one full twist.
One boundary component is the
z-axis, and the other a circle
in the (x, y) -plane.

Its triple cover ramified
along one boundary component.

Fig. 14.4

embedded in S^3 with one full twist, ramified along one component of the boundary (see Figure 14.4).

References

- [A] AHLFORS, L., *Lectures on quasi-conformal mappings*. Van Nostrand, 1966.
- [A-B] AHLFORS, L. & BERS, L., Riemann's mapping theorem for variable metrics. *Ann. of Math.*, 72 (1960), 385–404.
- [Al] ALEXANDER, J. W., On the subdivision of 3-space by a polyhedron. *Proc. Nat. Acad. Sci. U.S.A.*, 10 (1924), 6–8.
- [Bl] BLANCHARD, P., Complex analytic dynamics on the Riemann sphere. *Bull. Amer. Math. Soc.*, 11 (1984), 85–141.
- [Br] BROWN, M., A proof of the generalized Schoenflies theorem. *Bull. Amer. Math. Soc.*, 66 (1960), 74–76.
- [C] CHAVES, Private communication.
- [D-G-H] DEVANEY, R., GOLDBERG, L. & HUBBARD, J. Dynamics of the exponential map. Preprint.
- [D-H 1] DOUADY, A. & HUBBARD, J. Itération des polynômes quadratiques complexes. *C. R. Acad. Sci. Paris Ser. I Math.*, 294 (1982), 123–126.

- [D-H2] — *Étude dynamique des polynômes complexes, Première partie*. Publications Mathématiques d'Orsay, 1984.
- [D-H3] — On the dynamics of polynomial-like mappings *Ann. Sci. Ecole Norm. Sup. (4)*, 18 (1985), 287–343.
- [F] FATOU, P., Sur les équations fonctionnelles. *Bull. Soc. Math. France*, 47 (1919), 161–271; 48 (1920), 33–94 and 208–314.
- [J] JULIA, G., Mémoires sur l'itération des fonctions rationnelles. *J. Math. Pures Appl. (7)*, 4 (1918), 47–245.
- [M-S-S] MAÑE, R., SAD, P. & SULLIVAN, D., On the dynamics of rational maps. *Ann. Sci. Ecole Norm. Sup. (4)*, 16 (1983), 193–217.
- [M] MILNOR, J., The cubic Mandelbrot set. Preprint 1986.
- [R] RUDIN, W., *Real and complex analysis*. McGraw Hill, 1966, 1974.
- [S] SULLIVAN, D., Quasi-conformal homeomorphisms and dynamics, I, II, III. Preprint I.H.E.S.

Received July 15, 1986

Received in revised form January 23, 1987