

## MINIMAL GENUS SEIFERT SURFACES FOR SPECIAL ARBORESCENT LINKS

MAKOTO SAKUMA

(Received March 3, 1993)

### Introduction

The unique prime decomposition theorem of knots and links proved by Schubert [26] and Hashizume [11] reduces the classification problem of links to that of prime links, and it is also useful for the study of symmetries of composite links (see [21, 22]). In [2], Bonahon and Siebenmann studied decompositions of links by Conway spheres, i.e., spheres meeting links in four points, and established the characteristic splitting theorem of the simple links into the algebraic parts and the non-algebraic parts. They also carried out minute study of the algebraic parts, which leads to the determination of the symmetry groups of the algebraic links, or the arborescent links, except those of the Montesions links with three branches. (For the symmetry groups of the Montesions links with 3 branches, see [1] and [23].)

The concept of Murasugi sum (see [19]) generalizes the concept of connected sum, and in certain cases, Conway spheres come from Murasugi sums. So it seems to be natural to raise the following problem (see [20, Section 7]):

**Problem 0.1.** *Is there a certain kind of uniqueness in the decomposition of links into Murasugi sums?*

Since Murasugi sum is a concept defined not for links themselves but for Seifert surfaces for links, we need to treat the following two problems when we consider the above problem:

(1) Classify the minimal genus (or incompressible) Seifert surfaces for links.

(2) Classify the Murasugi sum structures of Seifert surfaces.

One purpose of this paper is to study these problems for *special arborescent links*, that is, links obtained from unknotted nontrivially twisted annuli by successive plumbing (see Section 2). In fact, we classify the minimal genus Seifert surfaces for these links (Theorem 2.3); and

for a certain subclass of these links, which we call the *very special arborescent links*, we classify their decompositions into “4-Murasugi sums” (Theorem 2.4). Since every 2-bridge knot is a special arborescent link, Theorem 2.3 may be considered as a generalization of a part of the results of Hatcher and Thurston [12]. By making use of these results, we classify the very special arborescent links (Theorem 2.6), and determine the symmetry groups of these links (Theorem 2.7). This recovers a part of the results of Bonahon and Siebenmann [2]. Though the links we consider in this paper constitute only a special subclass of the links considered by [2], our approach has the advantage that it gives a unified calculation of the symmetry groups of links including certain Montesons links with 3 branches and certain 2-bridge links without invoking the results of Schubert [27].

The other purpose of this paper is concerned with a conjecture raised by Kakimizu [13]. In [13, 14], he introduced a certain simplicial complex  $MS(L)$  [resp.  $IS(L)$ ] whose vertex set is the set of the equivalence classes of the minimal genus [resp. incompressible] Seifert surfaces for  $L$ . A result of Scharlemann and Thompson [24, Proposition 5] says that  $MS(L)$  is connected, and it is proved by Kakimizu [14, Theorem A] that  $IS(L)$  is also connected. Further, he proposed the following conjecture [13]:

**Conjecture 0.2.**  *$MS(L)$  and  $IS(L)$  are contractible.*

In [15], he verified this conjecture for prime knots up to 10 crossings by developing the methods initiated by Gabai [5, 6, 7, 8, 9] and Kobayashi [16]. In this paper we prove this conjecture for  $MS(L)$  with  $L$  a special arborescent link, by showing that it is homeomorphic to a finite dimensional ball (Theorem 3.3 and Proposition 3.11). Theorem 3.3 is also used when we calculate the symmetry groups of the very special arborescent links.

This paper is organized as follows. In Section 1, we recall the definition of the Murasugi sum, and introduce the concept of a composition of Murasugi sums. In Section 2, we give the definition of the special arborescent links, and state our results concerning the classification of the minimal genus Seifert surfaces and the calculation of the symmetry groups. In Section 3, we recall the definition of the complex  $MS(L)$ , and state the precise structure of  $MS(L)$  for a special arborescent link  $L$ . In Section 4, we provide fundamental tools for our purpose; we recall the concept of a sutured manifold, and state its relations with the Murasugi sum. The remaining Sections 5, 6, 7, and 8 are devoted to the proof of the results.

## TERMINOLOGY AND NOTATION

$S^3$  denotes the 3-sphere with a fixed orientation. For a link  $L$  in  $S^3$ ,  $E(L) = cl(S^3 - N(L))$  is the exterior of  $L$ , where  $N(L)$  is a fixed regular neighbourhood of  $L$  in  $S^3$ . A Seifert surface for an oriented link  $L$  in  $S^3$  is an oriented surface  $F$  in  $S^3$  without closed components such that  $\partial F = L$  as oriented links. We always assume that  $F$  intersects each component of  $N(L)$  in an annulus and that  $F \cap E(L)$  is properly embedded in  $E(L)$ . We refer to  $F \cap E(L)$  by denoting the same symbol  $F$ . Two Seifert surfaces for  $L$  are said to be *equivalent*, if they are *pairwise isotopic* in  $(S^3, L)$ ; i.e., they are isotopic by an isotopy of  $S^3$  which respects  $L$ . This is equivalent to the condition that they are isotopic as surfaces in  $E(L)$ . A Seifert surface  $F$  is *incompressible* [resp. of *minimal genus*], if  $F$  is incompressible in  $E(L)$  [resp. the Euler number  $\chi(F)$  is maximum among all Seifert surfaces for  $L$ ].

A link  $L$  is *semi-oriented* if an orientation of  $L$  is specified modulo simultaneous reversal of the orientations of the components of  $L$ . When we mention to Seifert surfaces of a semi-oriented link  $L$ , we fix an orientation of  $L$  which represents the semi-orientation of  $L$ .

$|\mathcal{K}|$ , where  $\mathcal{K}$  is a simplicial complex, denotes the underlying topological space for  $\mathcal{K}$ .

$|X|$ , where  $X$  is a topological space, denotes the number of the connected components.

$N(Y; X)$  or  $N(Y)$  in brief, where  $Y$  is a subspace of  $X$ , denotes a regular neighbourhood of  $Y$  in  $X$ .

A *closed up component* of  $X - Y$  means the closure in  $X$  of a connected component of  $X - Y$ .

$T$  denotes a finite plane tree; i.e., a finite tree embedded in the plane  $\mathbf{R}^2$ .

$V(T)$  denotes the set of the vertices of  $T$ .

$E(T)$  denotes the set of the edges of  $T$ .

$E(v, T)$ , where  $v$  is a vertex of  $T$ , denotes the set of the edges of  $T$  incident to  $v$ .

$w$  denotes a function from  $V(T)$  to  $\mathbf{Z} - \{0\}$ , where  $\mathbf{Z}$  is the ring of the integers.

$\rho$  denotes an orientation of  $T$ , i.e., an assignment of an orientation of each edge of  $T$ .

$(T'; \rho)$ , where  $T'$  is a subgraph of  $T$ , denotes the oriented graph whose underlying graph is  $T'$  and whose orientation is given by the restriction of  $\rho$  to  $T'$ . Similarly,  $(T', w; \rho)$  denotes the oriented and weighted graph whose weight is given by the restriction of  $w$  to  $V(T')$ .

$\mathcal{O}(T)$  denotes the set of the orientations of  $T$ .

1. Murasugi sum

Let  $F$  be a Seifert surface of an oriented link  $L$  in  $S^3$ . Suppose there is a decomposition of  $S^3$  into two 3-balls;  $S^3 = B_1^3 \cup B_2^3$ ,  $B_1^3 \cap B_2^3 = S^2$ , such that  $D = S^2 \cap F$  is a  $2n$ -gon (see Figure 1.1). Put  $F_i = B_i^3 \cap F$ , and give  $F_i$  the orientation induced from that of  $F$  for  $i=1,2$ . Then  $F$  is said to be a  $2n$ -Murasugi sum of the Seifert surfaces  $F_1$  and  $F_2$  along  $D$  (cf. [19]), and we call  $S^2$  a  $2n$ -Murasugi sphere for  $F$ . We also say that  $F$  has a  $2n$ -Murasugi decomposition into  $F_1$  and  $F_2$ . If  $n=1$ , then this decomposition gives a decomposition of the link  $L = \partial F$  into the connected sum of the links  $\partial F_1$  and  $\partial F_2$ . In case  $n=2$ , this operation is called a *plumbing*, and each 4-Murasugi sphere forms a Conway sphere for  $L$ . Two Murasugi spheres  $S_1^2$  and  $S_2^2$  for  $F$  are said to be *equivalent*, if there is an isotopy of  $S^3$  respecting  $F$  which carries  $S_1^2$  to  $S_2^2$ .

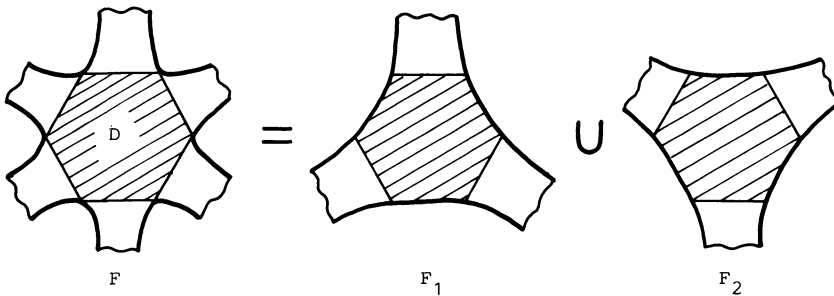

Figure 1.1

We say that a  $2n$ -Murasugi sphere is *essential*, if no closed up component of  $F_i - D$  ( $i=1,2$ ) is a disk which intersects  $D$  in an arc. If a  $2n$ -Murasugi sphere is not essential, it yields a  $2(n-1)$ -Murasugi sphere as illustrated in Figure 1.2.

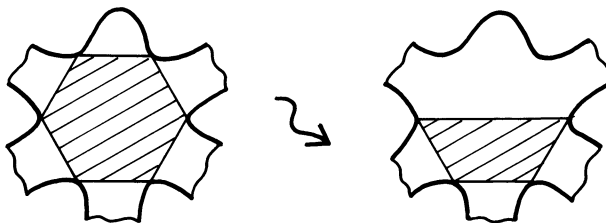

Figure 1.2

Even if the pairs  $(F_1, D)$  and  $(F_2, D)$  are specified, there are two kinds of Murasugi sums of  $F_1$  and  $F_2$  along  $D$  according to the direction of the normal vector  $\nu$  to  $D$ . [Here  $\nu$  is defined as follows: Let  $e_1$  and  $e_2$  be vectors on  $D$  such that the exterior product  $e_1 \wedge e_2$  is coherent with the orientation of  $D$ . Then  $e_1 \wedge e_2 \wedge \nu$  is coherent with the orientation of  $S^3$ .] Suppose  $\nu$  points into  $B_1^3$ ; then we express the Murasugi sum (or the Murasugi decomposition) by the symbol  $F_1 \triangleleft F_2$ . Consider the surface defined by  $F' = cl(F - D) \cup D'$ , where  $D' = cl(S^2 - D)$ , and give  $F'$  the orientation induced from that of  $cl(F - D) (\subset F)$ . Then  $F'$  is also a Seifert surface for  $L = \partial F$ . Since  $(F_i, D)$  is isotopic to  $(cl(F_i - D) \cup D', D')$  in  $S^3$  ( $i=1,2$ ),  $F'$  can also be regarded as a Murasugi sum of  $F_1$  and  $F_2$  along

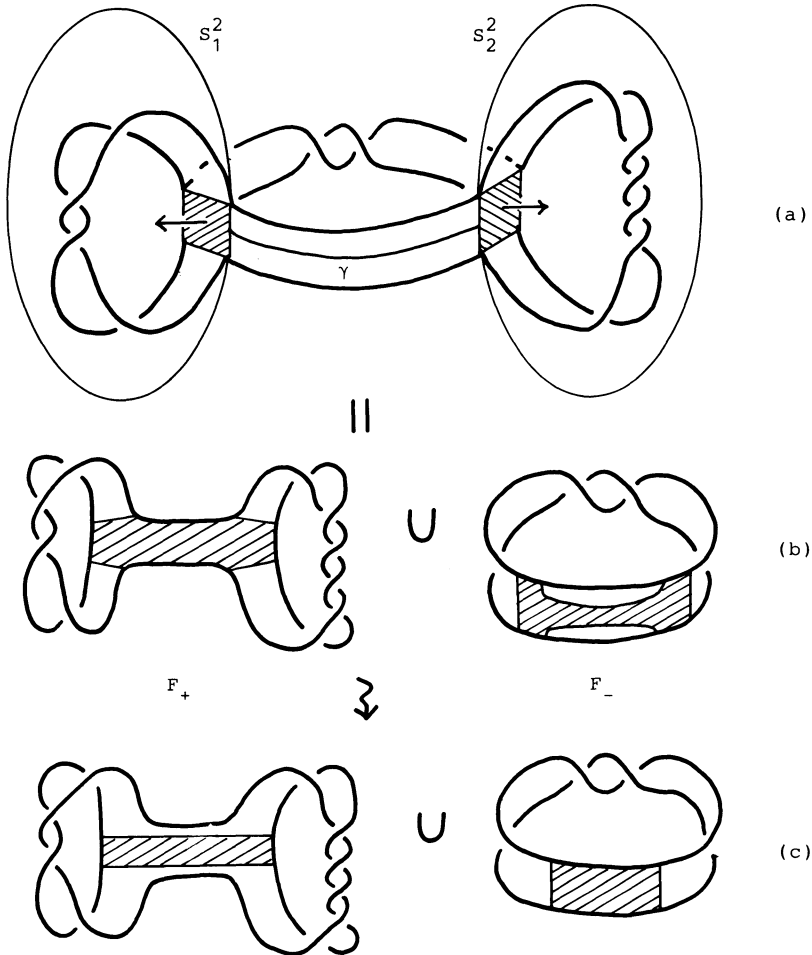

Figure 1.3

$D$ . However, the normal vector to  $D'$  points into  $B_2^3$ . Thus we denote this Murasugi sum by the symbol  $F_1 \triangleright F_2$ .  $F'$  is called the *dual* surface of  $F$  with respect to the Murasugi sum  $F_1 \triangleleft F_2$ .

We now define the concept of a *composition* of Murasugi spheres. Let  $S_1^2, \dots, S_r^2$  be mutually disjoint Murasugi spheres for a Seifert surface  $F$ . For each  $i$  ( $1 \leq i \leq r$ ), put  $D_i = S_i^2 \cap F$ , and orient  $S_i^2$  by the orientation of  $D_i$ . Suppose the following condition holds: For each closed up component  $P$  of  $S^3 - \cup_{i=1}^r S_i^2$ , either all the normal vectors to the boundary components of  $P$  point into  $P$  or otherwise point out of  $P$ . Suppose further that we are given a graph  $\gamma$  in  $cl(F - \cup_{i=1}^r D_i)$  such that  $(\cup_{i=1}^r D_i) \cup \gamma$  is contractible. Then the oriented 2-sphere obtained from  $\cup_{i=1}^r S_i^2$  by piping along  $\gamma$  determines a new Murasugi sphere for  $F$ . We call it the *composition* of the Murasugi spheres  $S_1^2, \dots, S_r^2$  along  $\gamma$ . To be more precise, let  $\mathcal{P}_+$  [resp.  $\mathcal{P}_-$ ] be the union of the closed up components of  $S^3 - \cup_{i=1}^r S_i^2$  where the normal vectors to the boundaries point into [resp. out of] the components, and let  $F_+$  [resp.  $F_-$ ] be the subsurface of  $F$  obtained from  $F \cap \mathcal{P}_+$  [resp.  $F \cap \mathcal{P}_-$ ] through boundary connected sum along the graph  $\gamma \cap \mathcal{P}_-$  [resp.  $\gamma \cap \mathcal{P}_+$ ]. Then the above 2-sphere determines a Murasugi decomposition  $F_+ \triangleleft F_-$  along a disk which is obtained from  $D_1, \dots, D_r$  through boundary connected sum along  $\gamma$  (see Figure 1.3 (a) and (b)). In some cases, the resulting Murasugi sphere is reducible (see Figure 1.3 (b) and (c)).

**2. Special arborescent links, and statement of results**

Let  $T$  be a finite plane tree, and let  $w$  be a function from  $V(T)$  to  $\mathbf{Z} - \{0\}$ . For each  $v \in V(T)$  we associate an unknotted annulus  $F(v)$  in  $S^3$  with  $w(v)$  right-hand full twists, where a core orientation  $c_v$  and a normal orientation  $n_v$  are specified as illustrated in Figure 2.1 (a). Let  $e_1, \dots, e_k$  be the elements of  $E(v, T)$ , and suppose they lie around  $v$  in this counter clockwise order (see Figure 2.1 (b)). Then we specify squares  $D(e_1, v), \dots, D(e_k, v)$  on the “flat” part of  $F(v)$  in this order as illustrated in Figure 2.1 (a).

If vertices  $v_1$  and  $v_2$  are joined by an edge  $e$ , then we plumb the bands  $F(v_1)$  and  $F(v_2)$  by gluing the squares  $D(e, v_1)$  and  $D(e, v_2)$  together using the rule  $c_{v_1} \leftrightarrow n_{v_2}$  and  $n_{v_1} \leftrightarrow c_{v_2}$ . The isotopy type of the resulting surface depends on the way of plumbing; but, the semi-oriented link which is obtained as the boundary of the surface is independent of the way of plumbing. We denote this semi-oriented link by the symbol  $L(T, w)$ , and call it the *special arborescent link* associated with the finite weighted plane tree  $(T, w)$ .

If we fix a base vertex  $v_*$ , and orient  $F(v)$  by  $c_v \wedge n_v$  or  $-c_v \wedge n_v$

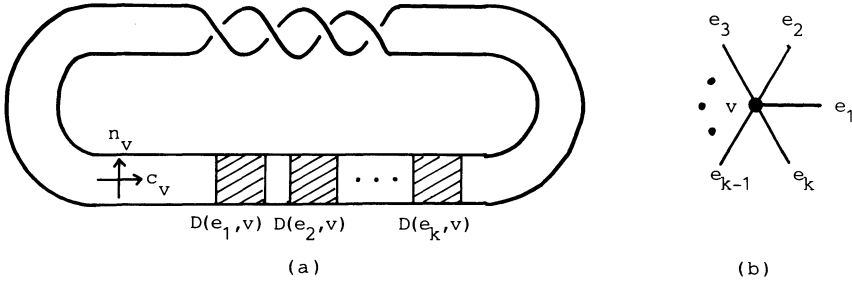

Figure 2.1

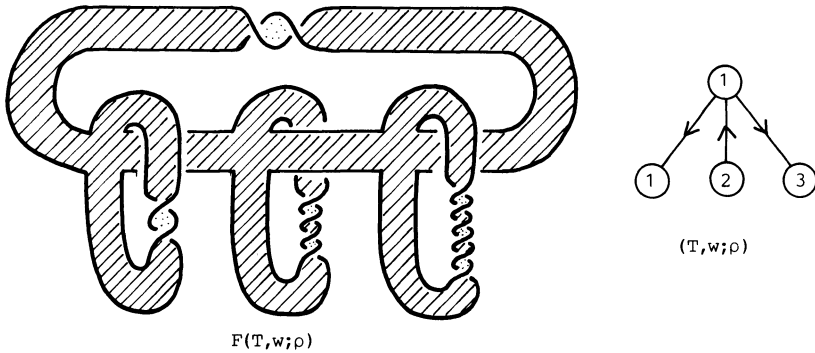

Figure 2.2

according as  $v$  is of even or of odd distance from  $v_*$ , then the gluing maps are orientation preserving, and therefore, the resulting surface can be oriented so that it is coherent with these orientations. Further, the way of the plumbing can be described by an *orientation*  $\rho$  of  $T$  by the following rule: Let  $v_1$  and  $v_2$ , respectively, be the initial point and the terminal point of an oriented edge  $(e; \rho)$ . Then plumb  $F(v_1)$  and  $F(v_2)$  so that  $F(v_2)$  lies above  $F(v_1)$  with respect the normal vector. The resulting surface is denoted by  $F(T, w; \rho)$  (see Figure 2.2).

In order to have all the surface  $F(T, w; \rho)$  for different  $\rho$ 's bounding a single link  $L(T, w)$ , we fix a position for  $L(T, w)$ , and reposition  $F(T, w; \rho)$  by a "canonical" isotopy of  $S^3$  which deforms  $\partial F(T, w; \rho)$  to  $L(T, w)$ . This can be done as follows. Perform the plumbing on the bands successively further and further away from the base vertex  $v_*$  eliminating the extra crossings created while plumbing. Then we obtain a "canonical projection" of  $L(T, w)$  as illustrated in Figure 2.3 (see [9, 1.9]). For each  $v \in V(T)$ , put  $A(v) = cl(F(v) - \cup_{e \in E(v, T)} D(e, v))$ , and  $A(T) = \cup_{v \in V(T)} A(v)$ .

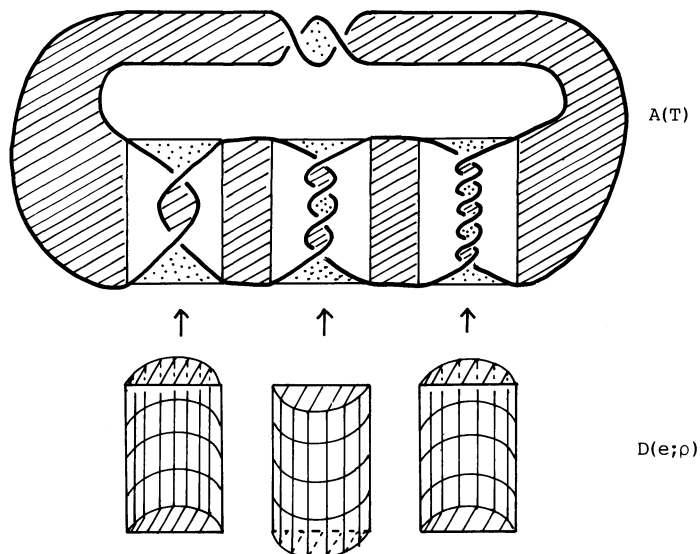

Figure 2.3

Then  $A(T)$  can be situated in  $S^3$  independently of the choice of  $\rho$  as illustrated in Figure 2.3. To construct the Seifert surface  $F(T, w; \rho)$ , we have only to specify the location of the square  $D(e, v_1) = D(e, v_2)$  for each  $e \in E(T)$ . (Here  $v_1$  and  $v_2$  denotes the end-points of  $e$ ). This can be done by plunging a square to  $A(T) \cup L(T, w)$  from the upper or lower side so that its boundary is equal to  $\partial D(e, v_1) = \partial D(e, v_2)$  and that this construction is consistent with the data specified by  $\rho$  (see Figure 2.3). We denote the plunged square by the symbol  $D(e; \rho)$ . Then we have  $F(T, w; \rho) = A(T) \cup (\cup_{e \in E(T)} D(e; \rho))$ .

Note that if  $\rho$  and  $\rho'$  induce different orientations on an edge  $e$  then the union  $D(e; \rho) \cup D(e; \rho')$  forms a 4-Murasugi sphere for  $F(T, w; \rho)$ , which we denote by  $S(e)$ . We can easily see the following:

**Lemma 2.1.** (1) *Let  $\mathcal{E}$  be a subset of  $E(T)$ . Then there exists a composition of the Murasugi spheres  $\{S(e)\}_{e \in \mathcal{E}}$  for  $F(T, w; \rho)$ , if and only if the following condition is satisfied: For each component  $B$  of  $T - \cup_{e \in \mathcal{E}} \text{int}(e)$ , let  $\mathcal{E}(B)$  be the subset of  $\mathcal{E}$  consisting of those elements which are incident to  $B$ ; then either all of the initial points or all of the terminal points of the oriented edges  $\{(e; \rho)\}_{e \in \mathcal{E}}$  lie in  $B$ .*

(2) *In case the above condition is satisfied, the dual surface of  $F(T, w; \rho)$  with respect to the resulting Murasugi sphere is equivalent to  $F(T, w; \rho')$ , where  $\rho'$  is the orientation of  $T$  obtained from  $\rho$  by reversing the orientations*



of the edges contained in  $\mathcal{E}$ .

We say that a vertex  $v$  of  $T$  is *positive* [resp. *negative*] with respect to an orientation  $\rho$  of  $T$ , if every edge  $e$  in  $E(v, T)$  is oriented by  $\rho$  so that  $v$  is the terminal point [resp. the initial point]. An orientation  $\rho$  of  $T$  is said to be *alternating*, if each of the vertices of  $T$  is either positive or negative with respect to  $\rho$ . Any tree with more than one vertices has precisely two alternating orientations. The condition in Lemma 2.1 (1) can be paraphrased as follows: Let  $\mathcal{T}$  be the tree obtained from  $T$  by shrinking each component of  $T - \cup_{e \in \mathcal{E}} \text{int}(e)$  to a point; then the orientation on  $\mathcal{T}$  induced by  $\rho$  is alternating.

Let  $\mathcal{O}(T)$  be the set of the orientations of  $T$ . If  $v$  is a vertex of  $T$  which is positive or negative with respect to  $\rho (\in \mathcal{O}(T))$ , then  $v(\rho)$  denotes the element of  $\mathcal{O}(T)$  obtained from  $\rho$  by reversing the orientations of the edges incident to  $v$ .

EXAMPLE 2.2. (1) Let  $\alpha$  be an arc lying on a small circle in the plane around a vertex  $v$  of  $(T; \rho)$  such that  $T \cap \alpha = T \cap \text{int}(\alpha) \neq \emptyset$  and that either all of the initial points or all of the terminal points of the oriented edges  $\{(e; \rho)\}_{e \cap \alpha \neq \emptyset}$  are equal to  $v$  (see Figure 2.4). Then the Murasugi spheres  $\{S(e)\}_{e \cap \alpha \neq \emptyset}$  are composable. Further, the resulting Murasugi sphere is reduced to an essential 4-Murasugi sphere (see Figure 1.3 (c)).

(2) Suppose  $v$  is a positive or negative vertex of  $(T; \rho)$  and  $|w(v)| = 1$ . Then, by the above observation,  $F(T, w; \rho)$  is a Murasugi sum of the Hopf band  $F(v)$  and another surface. Since  $F(v)$  is a fiber surface, i.e., a fiber of a fibration of a link exterior over  $S^1$ , the dual surface  $F(T, w; v(\rho))$  of  $F(T, w; \rho)$  with respect to this plumbing is equivalent to  $F(T, w; \rho)$  by [8, Corollary 3.2]. In this case, we say that  $v(\rho)$  is obtained from  $\rho$  by an *elementary operation*.

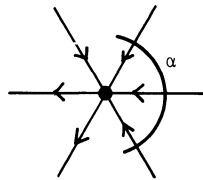

Figure 2.4

We shall prove the following theorem in Sections 5 and 6:

**Theorem 2.3.** (1) *Any minimal genus Seifert surface for a special*

arborescent link  $L(T, w)$  is equivalent to  $F(T, w; \rho)$  for some  $\rho \in \mathcal{O}(T)$ .

(2)  $F(T, w; \rho)$  is isotopic to  $F(T, w; \rho')$ , if and only if,  $\rho$  and  $\rho'$  are related by an iteration of finite number of elementary operations.

The structure theorem for the complex  $MS(L(T, w))$  shall be stated in the next section. We now state our results on the classification of the 4-Murasugi spheres. Unfortunately, we couldn't classify all 4-Murasugi spheres for general  $F(T, w; \rho)$ , and we need to restrict our attention to a certain subclass. A weight  $w$  on  $T$  is said to be *special* if  $|w(v)| \geq 2$  for any  $v \in V(T)$ . If  $w$  is special, the link  $L(T, w)$  is called a *very special arborescent link*.

**Theorem 2.4.** *Suppose  $L(T, w)$  is a very special arborescent link. Then any essential 4-Murasugi sphere for its minimal genus Seifert surface  $F(T, w; \rho)$  is equivalent to one that is described in Example 2.2 (1). Further, two such Murasugi spheres are equivalent, if and only if the corresponding arcs are ambient isotopic in  $(\mathbf{R}^2, T)$ .*

Kobayashi [17] and Scharelemann-Thompson [25] independently proved that any knot with unknotting number 1 has a minimal genus Seifert surface which is obtained by plumbing a Hopf band and another surface. Thus as a corollary to the above results, we obtain the following:

**Corollary 2.5.** *The unknotting number of any very special arborescent knot is greater than 1.*

To state the classification theorem for special arborescent links, we introduce a concept of equivalence among the finite plane trees. Recall that, for each vertex  $v$  of a plane tree  $T$ , the set  $E(v, T)$  is endowed with a cyclic order. An *isogeny* from a plane tree  $T$  to a plane tree  $T'$  is an isomorphism  $f$  between the abstract graphs  $T$  and  $T'$  which satisfies one of the following conditions:

(1)  $f$  preserves the cyclic order at every vertex, or reverses the cyclic order at every vertex.

(2)  $f$  reverses the cyclic order at one vertex and at each vertex at even distance from it; and  $f$  preserves the cyclic orders at the remaining vertices.

An *isogeny* between weighted plane trees  $(T, w)$  and  $(T', w')$  is an isogeny  $f$  between the plane trees  $T$  and  $T'$  such that  $w'(f(v)) = \epsilon w(v)$  for any  $v \in V(T)$ , where  $\epsilon = +1$  or  $-1$  and  $\epsilon$  does not depend on  $v$ . We define the *degree* of the isogeny  $f$  by  $\deg(f) = \epsilon$ . Two weighted plane trees are said to be *isogenic* [resp. (+)-*isogenic*] if there is an isogeny

[resp. an isogeny of degree +1] between them.

An *isomorphism* between two semi-oriented links  $(S^3, L)$  and  $(S^3, L')$  is a homeomorphism  $g$  between the pairs  $(S^3, L)$  and  $(S^3, L')$  such that  $g(L) = \pm L'$ . We define the degree of  $g$  by its degree as a self-homeomorphism of  $S^3$ . Two semi-oriented links are said to be *isomorphic*, [resp. (+)-*isomorphic*] if there is an isomorphisms [resp. an isomorphism of degree +1] between them.

**Theorem 2.6.** *Let  $(T, w)$  and  $(T', w')$  be finite weighted plane trees, such that the weights  $w$  and  $w'$  are special. Then the semi-oriented links  $L(T, w)$  and  $L(T', w')$  are isomorphic [resp. (+)-isomorphic], if and only if  $(T, w)$  and  $(T', w')$  are isogenic [resp. (+)-isogenic].*

The *symmetry group*  $Sym(T, w)$  [resp. the (+)-*symmetry group*  $Sym+(T, w)$ ] of a weighted plane tree  $(T, w)$  is the group of the self-isogenies [resp. the self-isogenies of degree +1] of  $(T, w)$ . The *symmetry group*  $Sym_s(S^3, L)$  [resp. the (+)-*symmetry group*  $Sym_s^+(S^3, L)$ ] of a semi-oriented link  $(S^3, L)$  is the group of the self-isomorphisms [resp. the self-isomorphisms of degree +1] of the semi-oriented link  $(S^3, L)$  modulo those isomorphisms which are pairwise isotopic to the identity.

**Theorem 2.7.** *For a very special arborescent link  $L(T, w)$ , we have an exact sequence;*

$$1 \rightarrow \Gamma(T) \rightarrow Sym_s(S^3, L(T, w)) \rightarrow Sym(T, w) \rightarrow 1,$$

which restrict to an exact sequence,

$$1 \rightarrow \Gamma(T) \rightarrow Sym_s^+(S^3, L(T, w)) \rightarrow Sym^+(T, w) \rightarrow 1.$$

Here  $\Gamma(T)$  is isomorphic to (1)  $\mathbf{Z}_2 \oplus \mathbf{Z}_2$ , (2)  $\mathbf{Z}_2$ , or (3) 1 according as (1)  $|T|$  is an interval or a point, (2)  $|T|$  is neither an interval nor a point, and there is a vertex  $v_0$  of  $T$  such that any vertex at an odd distance from  $v$  has valency 1 or 2, or (3) otherwise.

### 3. Simplicial complexes $MS(L)$

For an oriented link  $L$  in  $S^3$ , Kakimizu [14] defined a simplicial complex  $MS(L)$  and  $IS(L)$  as follows:

(1) The vertex set of  $MS(L)$  [resp.  $IS(L)$ ] is the set of the equivalence classes of the minimal genus [resp. incompressible] Seifert surfaces for  $L$ .

(2) A set of  $k+1$  vertices  $\{\sigma_0, \sigma_1, \dots, \sigma_k\}$  of  $MS(L)$  [resp.  $IS(L)$ ] spans a  $k$ -simplex of  $MS(L)$  [resp.  $IS(L)$ ], if and only if there are

representatives  $F_0, F_1, \dots, F_k$  of  $\sigma_0, \sigma_1, \dots, \sigma_k$  which are mutually disjoint in  $E(L)$ .

In this section, we study  $MS(L(T, w))$ . Put  $n = |V(T)| - 1 = |E(T)|$ . A cycle in  $\mathcal{O}(T)$  is a sequence

$$\rho_0 \xrightarrow{v_0} \rho_1 \xrightarrow{v_1} \dots \rightarrow \rho_n \xrightarrow{v_n} \rho_0,$$

where  $\{v_0, v_1, \dots, v_n\} = V(T)$ , and  $\{\rho_0, \rho_1, \dots, \rho_n\}$  are mutually distinct elements of  $\mathcal{O}(T)$  such that  $v_i$  is positive with respect to  $\rho_i$  and  $\rho_{i+1} = v_i(\rho_i)$  ( $0 \leq i \leq n$ ). In brief, we denote the cycle by  $(\rho_0, \rho_1, \dots, \rho_n)$ . Let  $\mathcal{K}(T)$  be the simplicial complex defined as follows:

- (1) The vertex set  $V(\mathcal{K}(T))$  is  $\mathcal{O}(T)$ .
- (2) A set of vertices  $\{\rho_0, \rho_1, \dots, \rho_k\}$  of  $\mathcal{K}(T)$  spans a  $k$ -simplex of  $\mathcal{K}(T)$  if there is a cycle in  $\mathcal{O}(T)$  containing it.

EXAMPLE 3.1. If  $T$  has two [resp. three] vertices, then  $\mathcal{K}(T)$  gives a triangulation of  $I$  [resp.  $I^2$ ] as illustrated in Figure 3.1.

For a finite weighted tree  $(T, w)$ , let  $\mathcal{K}(T, w)$  be the simplicial complex obtained from  $\mathcal{K}(T)$  by collapsing each dege of the form  $\overline{\rho \cdot v(\rho)}$  to a

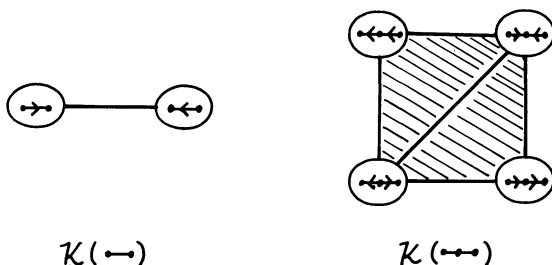

Figure 3.1

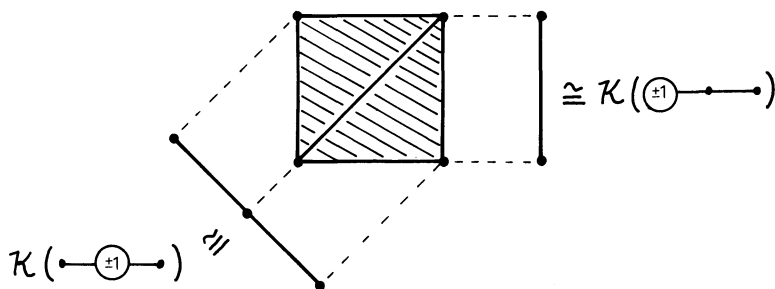

Figure 3.2

point, where  $v$  is a vertex of  $T$  with  $|w(v)|=1$  which is positive or negative with respect to  $\rho$ .

EXAMPLE 3.2. If  $T$  has three vertices, and just one vertex of  $T$  has weight 1, then  $\mathcal{K}(T,w)$  is as illustrated in Figure 3.2.

We shall prove the following theorem in Section 5.

**Theorem 3.3.**  *$MS(L(T,w))$  is isomorphic to  $\mathcal{K}(T,w)$ .*

In the rest of this section, we clarify the structure of  $\mathcal{K}(T,w)$  (Propositions 3.9 and 3.11).

**Lemma 3.4.** *Let  $T$  be a finite tree, and let  $\rho$  be an element of  $\mathcal{O}(T)$ . Then there is a cycle in  $\mathcal{O}(T)$  containing  $\rho$ .*

Proof. We use induction on  $n=|E(T)|$ . By Example 3.1, this lemma holds for  $n=1$  and 2. Let  $T$  be a finite tree with  $n \geq 2$ . Let  $v_*$  be a vertex of  $T$  whose valency is not 1, and let  $T'$  and  $T''$  be the closed up components of  $T - \{v_*\}$ . Then  $\mathcal{O}(T)$  can be identified with the Cartesian product  $\mathcal{O}(T') \times \mathcal{O}(T'')$ . Here  $\rho \in \mathcal{O}(T)$  corresponds to  $(\rho', \rho'')$ , where  $\rho'$  and  $\rho''$  are the restrictions of  $\rho$  to  $T'$  and  $T''$  respectively. Put  $r=|E(T')|$  and  $s=|E(T'')|$ . Then  $r < n$ ,  $s < n$ , and  $n=r+s$ . By the inductive hypothesis, there are a cycle

$$\tau'_0 \xrightarrow{v'_0} \tau'_1 \xrightarrow{v'_1} \dots \rightarrow \tau'_r \xrightarrow{v'_r} \tau'_0$$

in  $\mathcal{O}(T')$  containing  $\rho'$  and a cycle

$$\tau''_0 \xrightarrow{v''_0} \tau''_1 \xrightarrow{v''_1} \dots \rightarrow \tau''_s \xrightarrow{v''_s} \tau''_0$$

in  $\mathcal{O}(T'')$  containing  $\rho''$ . We may suppose  $v'_r = v''_s = v_*$ . Let  $p$  and  $q$  be the integers such that  $\tau'_p = \rho'$  and  $\tau''_q = \rho''$ . Now consider a shortest path contained in the lattice in the plane from  $(0,0)$  to  $(r,s)$  through  $(p,q)$ , and let  $(i_0, j_0) = (0,0), (i_1, j_1), \dots, (i_n, j_n) = (r,s)$  be the integral points on the path in this order. Then we can see that  $(\tau'_{i_0}, \tau''_{j_0}), (\tau'_{i_1}, \tau''_{j_1}), \dots, (\tau'_{i_n}, \tau''_{j_n})$  forms a cycle in  $T$  containing  $\rho = (\rho', \rho'')$ . In fact, for each  $k$  ( $0 \leq k \leq n-1$ ),  $(\tau'_{i_{k+1}}, \tau''_{j_{k+1}})$  is obtained from  $(\tau'_{i_k}, \tau''_{j_k})$  by the operation of  $v'_{i_k}$  or  $v''_{j_k}$  according as  $(i_{k+1}, j_{k+1}) = (i_k + 1, j_k)$  or  $(i_k, j_k + 1)$ ; and  $(\tau'_{i_0}, \tau''_{j_0})$  is obtained from  $(\tau'_{i_n}, \tau''_{j_n})$  by the operation of  $v_*$ .

Let  $\rho$  and  $\rho'$  be two elements of  $\mathcal{O}(L)$ . Put  $E(\rho, \rho') = \{e \in E(T) | \rho|_e \neq \rho'|_e\}$ ,

and let  $V(\rho, \rho')$  be the set of the components of  $T - \cup_{e \in E(\rho, \rho')} \text{int}(e)$ . Let  $T(\rho, \rho')$  be the tree with the vertex set  $V(\rho, \rho')$  and the edge set  $E(\rho, \rho')$ . As a topological space,  $T(\rho, \rho')$  is obtained from  $T$  by collapsing each subtree  $B (\in V(\rho, \rho'))$  to a point. Let  $[\rho]$  and  $[\rho']$  be the orientations of  $T(\rho, \rho')$  induced by  $\rho$  and  $\rho'$  respectively.

**Lemma 3.5.** *There is a cycle in  $T$  containing  $\rho$  and  $\rho'$  if and only if the orientation  $[\rho]$  of  $T(\rho, \rho')$  is alternating.*

Proof. Suppose there is a cycle

$$\tau_0 \xrightarrow{v_0} \tau_1 \xrightarrow{v_1} \cdots \rightarrow \tau_n \xrightarrow{v_n} \tau_0$$

in  $\mathcal{O}(T)$  with  $\rho = \tau_0$  and  $\rho' = \tau_p$  for some  $p$  ( $1 \leq p \leq n$ ). Put  $V_1(T) = \{v_i | 0 \leq i \leq p-1\}$ , and  $V_2(T) = \{v_i | p \leq i \leq n\}$ . Then we see that  $E(\rho, \rho')$  consists of those edges  $e$  such that precisely one of the end-points of  $e$  is contained in  $V_1(T)$ . Thus, for each  $B \in V(\rho, \rho')$ , the vertex set  $V(B)$  of the subtree  $B$  is contained in either  $V_1(T)$  or  $V_2(T)$ . Further  $B$  is a positive vertex or a negative vertex of the oriented tree  $(T(\rho, \rho'); [\rho])$  according as  $V(B)$  is contained in  $V_1(T)$  or  $V_2(T)$ . Hence the orientation  $[\rho]$  is alternating.

Conversely, suppose that the orientation  $[\rho]$  is alternating. Let  $B_1, B_2, \dots, B_r$  [resp.  $B_{r+1}, B_{r+2}, \dots, B_{r+s}$ ] be the positive [resp. negative] vertices of  $(T(\rho, \rho'); [\rho])$ . By Lemma 3.4, there is a cycle

$$\tau_{i,0} \xrightarrow{v_{i,0}} \tau_{i,1} \xrightarrow{v_{i,1}} \cdots \rightarrow \tau_{i,n_i} \xrightarrow{v_{i,n_i}} \tau_{i,0}$$

in  $\mathcal{O}(B_i)$  with  $\tau_{i,0} = \rho|_{B_i}$  for each  $i$  ( $1 \leq i \leq r+s$ ). By using the positivity of the vertex  $B_1$  in  $(T(\rho, \rho'); [\rho])$ , we see that the sequence of the vertices  $v_{1,0}, v_{1,1}, \dots, v_{1,n_1}$  can operate on  $\rho$  successively in this order. The resulting orientation  $\rho_1 = v_{1,n_1}(\dots v_{1,1}(v_{1,0}(\rho)))$  is obtained from  $\rho$  by reversing the orientations of the edges in  $E(\rho, \rho')$  which are incident to  $B_1$ . The vertices  $B_2, \dots, B_r$  remain to be positive in  $(T(\rho, \rho'); [\rho_1])$ . Thus, by repeating the above argument, we see that the sequence of the vertices  $v_{2,0}, v_{2,1}, \dots, v_{2,n_2}, \dots, v_{r,0}, v_{r,1}, \dots, v_{r,n_r}$  can operate on  $\rho_1$  successively in this order. We see that the resulting orientation is equal to  $\rho'$  and that  $B_{r+1}, \dots, B_{r+s}$  are positive in  $(T(\rho, \rho'); [\rho'])$ . Hence the sequence of the vertices  $v_{r+1,0}, v_{r+1,1}, \dots, v_{r+1,n_{r+1}}, \dots, v_{r+s,0}, v_{r+s,1}, \dots, v_{r+s,n_{r+s}}$  can operate on  $\rho'$  successively in this order. The resulting orientation is equal to  $\rho$ . The above process gives a cycle in  $\mathcal{O}(T)$  containing  $\rho$  and  $\rho'$ .

From the above proof, we see the following:

REMARK 3.6. (1) In each cycle in  $\mathcal{O}(T)$  containing  $\rho$  and  $\rho'$ , the elements of  $V(T)$  contained in positive [resp. negative] vertices of  $(T(\rho, \rho'); [\rho])$  are used in the part of the cycle from  $\rho$  to  $\rho'$  [resp. from  $\rho'$  to  $\rho$ ].

(2) Suppose  $(T(\rho, \rho'); [\rho])$  is alternating and  $|w(v)|=1$  either for every  $v \in V(T)$  which is contained in positive vertices of  $(T(\rho, \rho'); [\rho])$  or for every  $v \in V(T)$  which is contained in negative vertices of  $(T(\rho, \rho'); [\rho])$ . Then  $\rho$  and  $\rho'$  are related by a finite sequence of elementary operations.

We now recall the concept of an *ordered simplicial complex* (see [3, pp.67–68]). A simplicial complex is *ordered* if, for each simplex, an order of its vertices is given such that the order of each simplex agrees with the orders of faces. This is equivalent to a binary relation  $\leq$  on  $V(\mathcal{K})$ , such that (i)  $v_1 \leq v_2$  and  $v_2 \leq v_1$  imply  $v_1 = v_2$ , (ii)  $v_1$  and  $v_2$  are vertices of a simplex of  $\mathcal{K}$  if and only if  $v_1 \leq v_2$  or  $v_1 \geq v_2$  holds, and (iii) if  $v_1, v_2, v_3$  are vertices of a simplex of  $\mathcal{K}$  and  $v_1 \leq v_2$  and  $v_2 \leq v_3$ , then  $v_1 \leq v_3$ . The Cartesian product  $\mathcal{K}_1 \times \mathcal{K}_2$  of two ordered simplicial complex  $\mathcal{K}_1$  and  $\mathcal{K}_2$  is defined as follows: Define a binary relation  $\leq$  in  $V(\mathcal{K}_1) \times V(\mathcal{K}_2)$  by the rule  $(v_1, w_1) \leq (v_2, w_2)$  if and only if  $v_1 \leq v_2$  and  $w_1 \leq w_2$ . Then  $\mathcal{K}_1 \times \mathcal{K}_2$  is an ordered simplicial complex consisting of those simplices whose vertices are simply ordered by this partial order. We have a canonical homeomorphism  $|\mathcal{K}_1 \times \mathcal{K}_2| \cong |\mathcal{K}_1| \times |\mathcal{K}_2|$  (cf. [3, p.68]).

Let  $T$  be a finite tree and  $v_*$  a fixed vertex. Define a relation  $\leq$  on  $\mathcal{O}(T)$  by the rule;  $\rho \leq \rho'$  if there is a cycle  $(\rho_0, \rho_1, \dots, \rho_n)$  in  $\mathcal{O}(T)$  with  $\rho_0 = v_*(\rho_n)$ ,  $\rho = \rho_i$ , and  $\rho' = \rho_j$  where  $i$  and  $j$  are integers such that  $0 \leq i \leq j \leq n$ .

**Lemma 3.7.** *With the above relation  $\mathcal{K}(T)$  is an ordered simplicial complex.*

Proof. By Lemma 3.5 and Remark 3.6 (1), we see  $\rho \leq \rho'$  if and only if  $\rho = \rho'$  or the orientation  $[\rho]$  on  $T(\rho, \rho')$  is alternating and the vertex  $B$  of the oriented tree  $(T(\rho, \rho'); [\rho])$  containing  $v_*$  (as a subtree of  $T$ ) is negative. Thus it follows that this relation does not depend on the choice of the cycles and that this relation satisfies Condition (i). It is clear that this relation satisfies Conditions (ii) and (iii). Thus we obtain the desired result.

From the proof of Lemma 3.4, we obtain the following:

**Lemma 3.8.** *Suppose the valency of the base vertex  $v_*$  is not 1. Let  $T$  and  $T''$  be the closed up components of  $T - \{v_*\}$ . Then the ordered simplicial complex  $\mathcal{K}(T)$  is isomorphic to the Cartesian product  $\mathcal{K}(T') \times \mathcal{K}(T'')$ , where  $\mathcal{K}(T')$  and  $\mathcal{K}(T'')$  are endowed with the structures of ordered simplicial complexes by using the vertex  $v_*$ .*

By repeatedly using the above lemma, we obtain the following:

**Proposition 3.9.**  *$\mathcal{K}(T)$  gives a triangulation of the  $n$ -dimensional cube  $I^n$  whose vertex set consists of its corners, where  $n = |E(T)|$*

REMARK 3.10. Though the topological type of  $|\mathcal{K}(T)|$  depends only on  $n$ , the combinatorial structure depends on the shape of  $T$ . For example, the complexes corresponding to  $T_1 = \bullet \rightarrow \bullet \rightarrow \bullet$  and  $T_2 = \begin{matrix} & \bullet & \\ & / \ \backslash & \\ \bullet & & \bullet \end{matrix}$  are different. In fact, the 3-simplices of  $\mathcal{K}(T_2)$  have a (unique) common edge, whereas there is no such edge in  $\mathcal{K}(T_1)$ .

To study  $\mathcal{K}(T, w)$ , we describe the homeomorphism from  $|\mathcal{K}(T)|$  to  $I^n$  more precisely. Fix a numbering  $\{e_1, e_2, \dots, e_n\}$  of the edges of  $T$ , and choose an alternating orientation, say  $\rho_+$ , on  $T$ . For each  $\rho \in \mathcal{O}(T)$ , we associate a corner point  $(\varepsilon_1, \varepsilon_2, \dots, \varepsilon_n)$  of  $I^n$  by the rule  $\varepsilon_i = 0$  or  $1$  according to whether the orientations on  $e_i$  induced by  $\rho$  and  $\rho_+$  are equal or not. From the proof of Proposition 3.9, we can see that this correspondence induces a homeomorphism from  $|\mathcal{K}(T)|$  to  $I^n$ . In the following we identify  $|\mathcal{K}(T)|$  and  $I^n$  through this homeomorphism.

First, we study the case where there is a unique vertex, say  $v_1$ , of  $T$  such that  $|w(v_1)| = 1$ . For each orientation  $\rho$  such that  $\overline{\rho \cdot v_1(\rho)}$  is positive or negative with respect to  $\rho$ , the line-segment  $\overline{\rho \cdot v_1(\rho)}$  forms an edge of  $\mathcal{K}(T)$ ; and  $\mathcal{K}(T, w)$  is obtained from  $\mathcal{K}(T)$  by collapsing each of these edges to a point. We can see the following:

- (1) An edge of  $\mathcal{K}(T)$  is of this type if and only if it is parallel to the edge  $\overline{\rho_+ \cdot v_1(\rho_+)}$  in  $I^n$  ( $\subset \mathbf{R}^n$ ).
- (2) Each  $n$ -simplex of  $\mathcal{K}(T)$  contains a unique edge of this type.

Let  $H$  be a hyperplane in  $\mathbf{R}^n$  orthogonal to  $\overline{\rho_+ \cdot v_1(\rho_+)}$ , and let  $p: \mathbf{R}^n \rightarrow H$  be the orthogonal projection. Then, by the above observation, we see that the set of the images under  $p$  of the simplices in  $\mathcal{K}(T)$  forms a triangulation of the  $(n - 1)$ -dimensional ball  $p(I^n)$ , and that this simplicial complex is isomorphic to  $\mathcal{K}(T, w)$  (see Figure 3.2).

In general, let  $v_1, \dots, v_d$  be the set of vertices of  $T$  whose weights have absolute value 1. For each  $i$  ( $1 \leq i \leq d$ ), let  $H_i$  be the hyperplane in  $\mathbf{R}^n$  through the origin which is orthogonal to the edge  $\overline{\rho_+ \cdot v_i(\rho_+)}$ . Since the directions determined by  $\overline{\rho_+ \cdot v_i(\rho_+)}$  ( $1 \leq i \leq d$ ) are linearly independent



except when  $d=n+1$ , the dimension of the subspace of  $H = \cap_{i=1}^d H_i$  is equal to  $\max\{n-d, 0\}$ . Let  $p: \mathbf{R}^n \rightarrow H$  be the orthogonal projection. Then, as in the above, we can see the following:

**Proposition 3.11.** *The set of the images under  $p$  of the simplices of  $\mathcal{K}(T)$  forms a triangulation of the space  $p(I^n)$ , and this triangulation is isomorphic to  $\mathcal{K}(T, w)$ . In particular  $|\mathcal{K}(T, w)|$  is homeomorphic to the ball of dimension  $\max\{n-d, 0\}$ .*

#### 4. The complementary sutured manifold for a Seifert surface

First, we recall some fundamental concepts concerning sutured manifolds (cf. [7]). A *sutured manifold* is a pair  $(M, \gamma)$ , where  $M$  is a compact oriented 3-manifold and  $\gamma$  is a union of pairwise disjoint annuli in  $\partial M$ . For each component of  $\gamma$ , an oriented core circle (called a *suture*) is fixed, and  $s(\gamma)$  denotes the set of all sutures. Moreover  $cl(\partial M - \gamma)$  is a union of two surfaces  $R_+(\gamma)$  and  $R_-(\gamma)$  which are oriented so that  $\partial R_+(\gamma)$  and  $\partial R_-(\gamma)$  are homologous to  $s(\gamma)$  in  $\gamma$ . Since  $M$  is oriented, we can define a normal vector field to  $R_\varepsilon(\gamma)$  ( $\varepsilon = +$  or  $-$ ) as in Section 1. Then we can regard  $R_+(\gamma)$  [resp.  $R_-(\gamma)$ ] as the union of the components of  $cl(\partial M - \gamma)$  whose normal vectors point out of  $M$  [resp. into  $M$ ].  $(M, \gamma)$  is a *product sutured manifold* if  $M = F \times [-1, 1]$ ,  $\gamma = \partial F \times [-1, 1]$ ,  $R_+(\gamma) = F \times \{1\}$ , and  $R_-(\gamma) = F \times \{-1\}$ , where  $F$  is a compact oriented surface.

CONVENTION 4.1. We often identify  $R_\pm(\gamma)$  with the closed up component of  $\partial M - s(\gamma)$  containing  $R_\pm(\gamma)$ . In this case, we use the symbol  $\gamma$  to denote the suture  $s(\gamma)$ .

A disk  $Q$  properly embedded in  $(M, \gamma)$  is called a *2n-gon*, if  $\partial Q$  intersects  $s(\gamma)$  transversely in  $2n$  points. If  $Q$  is oriented, then by an operation called the *sutured manifold decomposition* of  $(M, \gamma)$  along  $Q$ , we obtain a new sutured manifold  $(M', \gamma')$  (see Figure 4.1). One copy, say  $Q_1$ , of  $Q$  in  $(M', \gamma')$  is a disk in  $R_+(\gamma')$ , and the other copy, say  $Q_2$ , of  $Q$  is a disk in  $R_-(\gamma')$ , such that  $Q_i \cap \gamma'$  consists of  $n$  arcs in  $\partial Q_i$  ( $i=1, 2$ ). In case  $n=2$ , we associate a *vertical mark* and a *horizontal mark* to each of  $Q_1$  and  $Q_2$  as illustrated in Figure 4.2. Then  $(M, \gamma)$  can be reconstructed from  $(M', \gamma')$  by identifying  $Q_1$  and  $Q_2$  so that the vertical mark and the horizontal mark for  $Q_1$  correspond to the horizontal mark and the vertical mark for  $Q_2$  respectively. A 2-gon is called a *product disk*, and a sutured manifold decomposition along a union of mutually disjoint product disks is called a *product decomposition*.

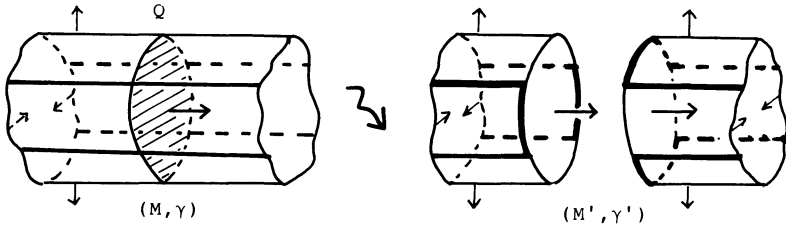

Figure 4.1

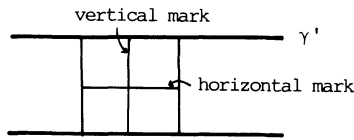

Figure 4.2

Let  $L$  be an oriented link in  $S^3$  and  $F$  a Seifert surface for  $L$ . Put  $N = N(F; E(L))$  and  $\delta = N \cap \partial E(L)$ , then  $(N, \delta)$  can be identified with  $(F \times [-1, 1], \partial F \times [-1, 1])$ , and we may suppose the normal vector to  $F = F \times \{0\}$  points to the  $+1$  side. Then by defining  $R_+(\delta) = F \times \{1\}$  and  $R_-(\delta) = F \times \{-1\}$ ,  $(N, \delta)$  becomes a product sutured manifold. We call it the *product sutured manifold* for  $F$ . The *complementary sutured manifold*  $(M, \gamma)$  for  $F$  is the sutured manifold  $(cl(E(L) - N), cl(\partial E(L) - \delta))$  with  $R_{\pm}(\gamma) = R_{\mp}(\delta)$ . Note that  $F$  is a fibre surface if and only if  $(M, \gamma)$  is a product sutured manifold. If we employ Convention 4.1, then  $(N, \delta)$  can be identified with  $(\tilde{N}, L)$ , where  $\tilde{N}$  is a *blister neighbourhood* of  $F$  in  $(S^3, L)$ ; i.e.,  $\tilde{N}$  is an embedded copy of  $F \times [-1, 1] / \sim$  in  $S^3$ , where  $\sim$  pinches  $\partial F \times [-1, 1]$ , by collapsing each arc  $x \times I$  to one point for each  $x \in \partial F$ ;  $F \times \{0\}$  and  $\partial F \times [-1, 1] / \sim$  correspond to  $F$  and  $L$  respectively. In this case  $(M, \gamma)$  can be identified with  $(cl(S^3 - \tilde{N}), L)$ .

Suppose  $F$  is a  $2n$ -Murasugi sum  $F_1 \triangleleft F_2$  of two Seifert surfaces  $F_1$  and  $F_2$ , and let  $S$  be the  $2n$ -Murasugi sphere corresponding to this Murasugi sum. We employ Convention 4.1 for the product sutured manifold  $(N, \delta)$  and the complementary sutured manifold  $(M, \gamma)$  for  $L$ ; thus  $N$  is identified with a blister neighbourhood of  $F$  in  $(S^3, L)$ . Put  $D = S \cap N$ . Then, we may suppose the following condition holds (see Figure 4.3):

CONDITION 4.2.  $D = D_0 \cup \{ \cup_{i=1}^{2n} \Delta_i \}$ , where

- (1)  $D_0 = D \cap F$  is a  $2n$ -gon with  $\partial D_0 = \alpha_1 \cup \alpha_2 \cup \dots \cup \alpha_{2n}$  in this cyclic

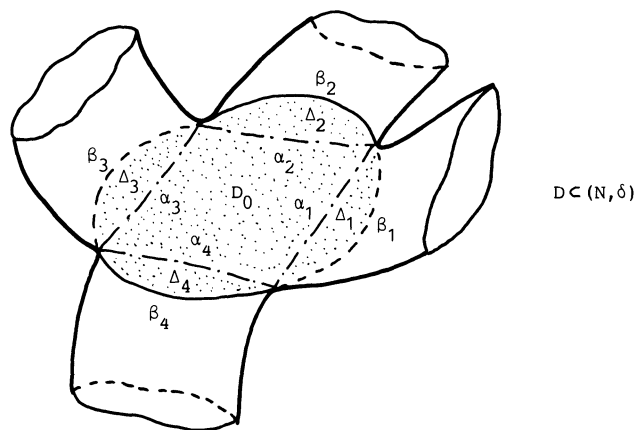

Figure 4.3

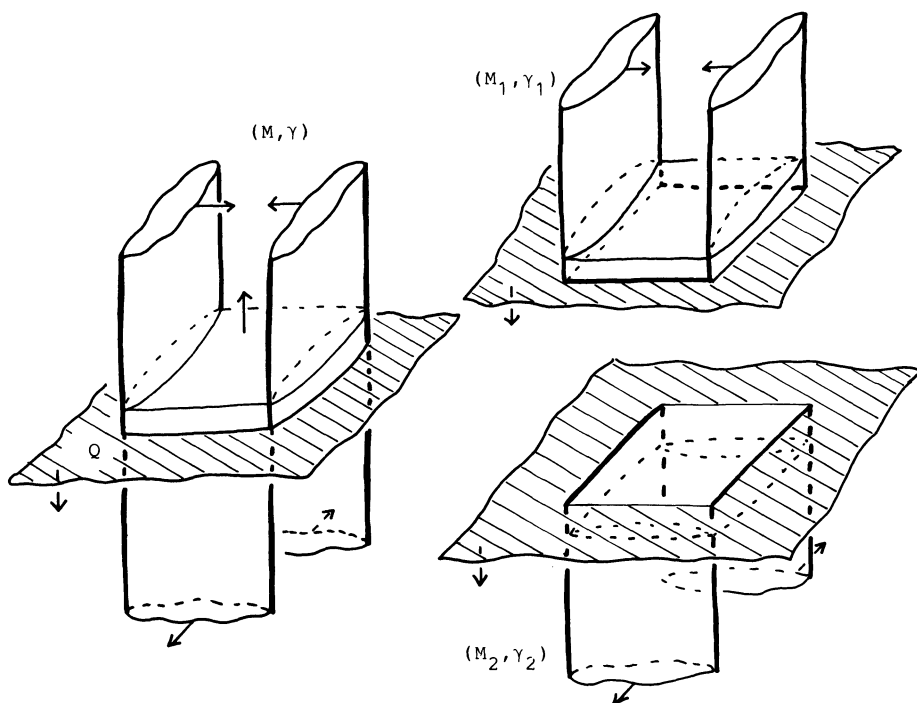

Figure 4.4

order,

(2)  $\Delta_i$  is a properly embedded disk in  $F \times [0, 1] / \sim$  or  $F \times [-1, 0] / \sim$  ( $\subset N$ ) according as  $i$  is even or odd, such that  $\partial \Delta_i = \alpha_i \cup \beta_i$ , where  $\beta_i$  is a properly embedded arc in  $F \times (-1)^i$ .

We orient  $D$  by using the orientation of  $D_0 \subset F$ . Put  $Q = cl(S - D)$  and orient it so that  $\partial Q$  is equal to  $\partial D$  as oriented circles. Then  $Q$  is a  $2n$ -gon in  $(M, \gamma)$ , and the sutured manifold obtained from  $(M, \gamma)$  by the sutured manifold decomposition along  $Q$  is the disjoint union of the complementary sutured manifolds  $(M_1, \gamma_1)$  and  $(M_2, \gamma_2)$  for  $F_1$  and  $F_2$  respectively as illustrated in Figure 4.4 (see [6, 10]). We say that a  $2n$ -gon  $Q$  in  $(M, \gamma)$  is *essential* if there is no disk in  $\partial M$  whose boundary is the union of an arc in  $\partial Q$  and an arc in  $\gamma$ . We see that a  $2n$ -Murasugi sphere is essential if and only if the corresponding  $2n$ -gon  $Q$  in  $(M, \gamma)$  is essential.

EXAMPLE 4.3. The Seifert surface  $F(T, w; \rho)$  introduced in Section 2 is obtained from the twisted annuli  $\{F(v)\}_{v \in V(T)}$  by successive plumbing. Let  $(M, \gamma)$  [resp.  $(M_v, \gamma_v)$ ] be the complementary sutured manifold of  $F(T, w; \rho)$  [resp.  $F(v)$ ]. For each edge  $e$  of  $T$ , put  $Q(e) = M \cap S(e)$ , where  $S(e)$  is the 4-Murasugi sphere corresponding to  $e$ , and  $Q(e)$  is oriented as indicated in the above. Put  $\mathcal{Q} = \cup_{e \in E(T)} Q(e)$ . Then

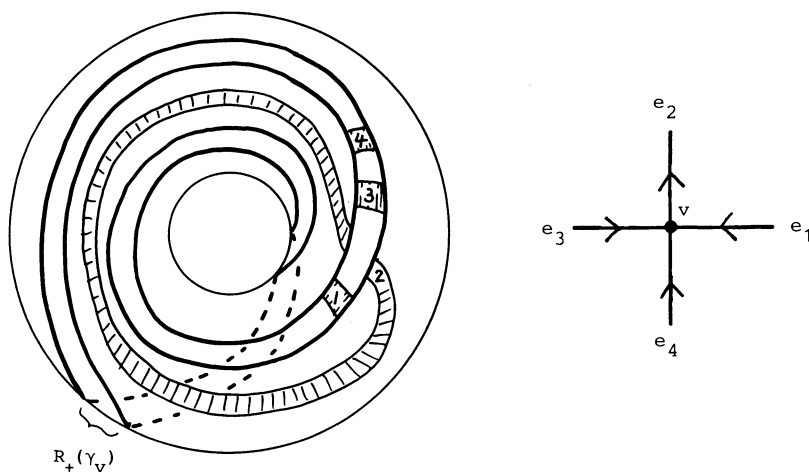

Figure 4.5

the sutured manifold obtained from  $(M, \gamma)$  through sutured manifold decomposition along  $\mathcal{Q}$  is the disjoint union of  $\{(M_v, \gamma_v)\}_{v \in V(T)}$ . For a vertex  $v$ , let  $e_1, e_2, \dots, e_k$  be the elements of  $E(v, T)$  lying around  $v$  in this counter-clockwise order. Then the copies of  $Q(e_1), Q(e_2), \dots, Q(e_k)$  in  $(M_v, \gamma_v)$  can be seen as illustrated in Figure 4.5. Note that, for each  $i$  ( $1 \leq i \leq r$ ), the copy of  $Q(e_i)$  in  $(M_v, \gamma_v)$  lies in  $R_+(\gamma_v)$  or  $R_-(\gamma_v)$  according as  $e_i$  is oriented by  $\rho$  so that  $v$  is the terminal point or the initial point.

The following proposition shall be used in Section 7.

**Proposition 4.4.** *For a connected Seifert surface  $F$  of an oriented link  $L$  in  $S^3$ , there is a bijection between the set of the equivalence classes of essential  $2n$ -Murasugi spheres for  $F$  and the set of the  $\gamma$ -isotopy classes of essential  $2n$ -gons  $Q$  in  $(M, \gamma)$  such that there is a  $2n$ -gon  $D$  in  $(N, \delta)$  with  $\partial D = \partial Q$  which satisfies Condition 4.2. Here two surfaces in  $(M, \gamma)$  are said to be  $\gamma$ -isotopic, if there is an isotopy of the pair  $(M, \gamma)$  sending one to the other.*

To prove this proposition, we need the following lemma.

**Lemma 4.5.** *Let  $D$  and  $D'$  be two  $2n$ -gons in  $(N, \delta)$  which satisfy Condition 4.2, and suppose  $\partial D = \partial D'$ . Then they are isotopic by an isotopy which is constant on  $\partial N$  and preserves  $F = F \times 0$ .*

*Proof.* By the assumption,  $D = D_0 \cup \{\cup_{i=1}^{2n} \Delta_i\}$  [resp.  $D' = D'_0 \cup \{\cup_{i=1}^{2n} \Delta'_i\}$ ], where  $D_0$  and  $\Delta_i$  [resp.  $D'_0$  and  $\Delta'_i$ ] are as in Condition 4.2. Let  $\alpha_i$  and  $\beta_i$  [resp.  $\alpha'_i$  and  $\beta'_i$ ] be as in Condition 4.2. Since  $\partial D = \partial D'$ , we may assume  $\beta_i = \beta'_i$ . Then  $\alpha_i$  is homotopic to  $\alpha'_i$  in  $N$  (and therefore in  $F$ ) keeping end-points fixed. Hence, by the proof of [4, Theorem 3.1],  $\cup_{i=1}^{2n} \alpha_i$  is isotopic to  $\cup_{i=1}^{2n} \alpha'_i$  by an isotopy which is fixed on  $\partial F$ . Thus, by the isotopy extension theorem, we may assume  $\alpha_i = \alpha'_i$  ( $1 \leq i \leq 2n$ ), and hence  $D_0 = D'_0$ . We now have  $\partial \Delta_i = \partial \Delta'_i$ , and therefore we see that  $\cup_{i=1}^{2n} \Delta_i$  and  $\cup_{i=1}^{2n} \Delta'_i$  are isotopic by an isotopy which is fixed on  $F \times \{-1, 0, 1\}$  ( $\subset N$ ). This completes the proof.

*Proof of Proposition 4.4.* First, we show that there is a well-defined map from the second set to the first set. Let  $Q$  be a  $2n$ -gon in  $(M, \gamma)$  such that there is a  $2n$ -gon  $D$  in  $(N, \delta)$  with  $\partial D = \partial Q$  which satisfies Condition 4.2. Put  $S = Q \cup D$ , then  $S$  is a  $2n$ -Murasugi sphere for  $F$ . By Lemma 4.5, the equivalence class of  $S$  does not depend on the choice of  $D$ . Thus, by using isotopy extension theorem, we can see that each  $\gamma$ -isotopy class of  $2n$ -gons in  $(M, \gamma)$  satisfying the required condition determines a unique equivalence class of Murauigi spheres. This map is clearly surjective.

Next, we show that that map is injective. Let  $Q_0$  and  $Q_1$  be  $2n$ -gons in  $(M, \gamma)$  satisfying the required condition, and let  $S_0$  and  $S_1$  be  $2n$ -Murasugi spheres for  $F$  determined by  $Q_0$  and  $Q_1$  respectively. Suppose  $S_0$  and  $S_1$  are equivalent; i.e., there is a level preserving self-homeomorphism  $\Phi = \{\phi_t\}_{0 \leq t \leq 1}$  of  $(S^3, F) \times [0, 1]$ , such that  $\phi_0 = 1$  and  $\phi_1(S_0) = S_1$ . We can find a very small blister neighbourhood  $N' (\subset N)$  of  $F$  such that, for any  $t$  ( $0 \leq t \leq 1$ ),  $D'_t = \phi_t(S_0) \cap N'$  is a  $2n$ -gon in the sutured manifold  $(N', \delta')$ , where  $\delta' = \delta = L$ . Consider the complementary sutured manifold  $(M', \gamma') = (cl(S^3 - N'), \delta')$ . Then  $Q'_t = cl(\phi_t(S_0) - D'_t)$  ( $0 \leq t \leq 1$ ) forms a continuous family of  $2n$ -gons in  $(M', \gamma')$ , and hence  $Q'_0$  and  $Q'_1$  are " $\gamma'$ -homotopic". By using [4, Theorem 2.1] and the fact that  $M'$  is irreducible (since  $F$  is connected), we see that  $Q'_0$  and  $Q'_1$  are  $\gamma'$ -isotopic. Hence  $Q_0$  and  $Q_1$  are  $\gamma$ -isotopic.

**REMARK 4.6.** Suppose  $n=2$ ; then the second set in Proposition 4.4 is equal to the set of the  $\gamma$ -isotopy classes of the 4-gons  $Q$  in  $(M, \gamma)$  such that  $\partial Q$  bounds a disk in  $(N, \delta)$ . This follows from the fact that any 4-gon in a product sutured manifold  $(N, \delta)$  is obtained by piping two mutually disjoint product disks along an arc in  $R_+(\delta)$  or  $R_-(\delta)$  (cf. [10, Lemma 2.3]).

Next, we present a fundamental observation due to Gabai (cf. [8]), which plays an important role in Sections 5 and 6. Let  $F$  and  $G$  be Seifert surfaces for an oriented link  $L$ , and suppose that they are disjoint in  $E(L)$ . Let  $E_1$  [resp.  $E_2$ ] be the closed up component of  $E(L) - (F \cup G)$ , such that the normal vector to  $F$  [resp.  $G$ ] points into  $E_1$  [resp.  $E_2$ ]. Put  $\delta_i = \partial E(L) \cap E_i$  ( $i=1, 2$ ). Then  $(E_1, \delta_1)$  [resp.  $(E_2, \delta_2)$ ] is a sutured manifold with  $R_-(\delta_1) = F$  and  $R_+(\delta_1) = G$  [resp.  $R_-(\delta_2) = G$  and  $R_+(\delta_2) = F$ ]. We call  $(E_1, \delta_1)$  [resp.  $(E_2, \delta_2)$ ] the sutured manifold between  $F$  and  $G$  [resp. between  $G$  and  $F$ ]. The following proposition follows from the argument of Gabai in [8, pp.529–530].

**Proposition 4.7.** *Suppose  $F$  is a Murasugi sum  $F_1 \triangleleft F_2$  of two Seifert surfaces  $F_1$  and  $F_2$ , and let  $F'$  be the dual surface of  $F$  with respect to this Murasugi sum. After a tiny isotopy,  $F'$  can be made disjoint from  $F$  in  $E(L)$ . Let  $(E_1, \delta_1)$  [resp.  $(E_2, \delta_2)$ ] be the sutured manifold between  $F$  and  $F'$  [resp. between  $F'$  and  $F$ ]. Then, for  $i=1, 2$ ,  $(E_i, \delta_i)$  has a product decomposition into the disjoint union of the complementary sutured manifold  $(M_i, \gamma_i)$  for  $F_i$  and a product sutured manifold.*

In the remainder of this section, we describe a fundamental tool for the study of isotopy types of surfaces and some of its consequences,

which are used in Sections 5, 6, and 8. Let  $F$  and  $G$  be properly embedded surfaces in a 3-manifold  $M$ , which meet each other transversely. A *blister* between  $F$  and  $G$  is an embedded copy  $P$  of  $\Sigma \times I / \sim$  with the following properties:

- (1)  $\sim$  pinches  $k \times I$ , with  $k$  a compact 1-submanifold of  $\partial\Sigma$ , by collapsing each arc  $x \times I$  to one point for each  $x \in k$ .
- (2)  $\Sigma \times 0$  [resp.  $\Sigma \times 1$ ,  $cl(\partial\Sigma - k) \times I$ ] is contained in  $F$  [resp.  $G$ ,  $\partial M$ ].
- (3)  $F \cap int(P) = \emptyset$ , and  $G \cap int(P)$  can be nonempty only when  $\Sigma$  is a disk and  $P \cap \partial M$  is connected.

The following result is essentially due to Waldhausen [28]:

**Proposition 4.8.** *Let  $M$  be a Haken manifold whose boundary is incompressible. Let  $F$  and  $G$  be incompressible, boundary-incompressible surfaces in  $M$ , which are in general position.*

- (1) *If  $F$  is isotopic to  $G$ , then there is a blister between  $F$  and  $G$ .*
- (2) *Suppose  $F \cap G \neq \emptyset$  and  $F$  is isotopic to a surface disjoint from  $G$ . Then there is a blister between  $F$  and  $G$ .*

Proof. (1) is a special case of [2, Proposition 6.21], and is proved by using the doubling trick and [28, Proposition 5.4].

(2) follows from the argument in [18, Proof of Theorem 5.4].

By using the proposition above, we can easily prove the following:

**Proposition 4.9.** *For an unsplittable link  $L$  in  $S^3$ , the following holds:*

- (1) *A set of vertices  $\{\sigma_0, \sigma_1, \dots, \sigma_k\}$  of  $MS(L)$  [resp.  $IS(L)$ ] spans a simplex in  $MS(L)$  [resp.  $IS(L)$ ] if and only if any sub-pair  $\{\sigma_i, \sigma_j\}$  ( $0 \leq i < j \leq k$ ) spans an edge of  $MS(L)$  [resp.  $IS(L)$ ].*
- (2) *Let  $(\sigma_0, \sigma_1, \dots, \sigma_k)$  be a  $k$ -simplex of  $MS(L)$  or  $IS(L)$ , and let  $F_0, F_1, \dots, F_k$  be mutually disjoint representatives for the vertices  $\sigma_0, \sigma_1, \dots, \sigma_k$ . Then the isotopy type of the union  $F_0 \cup F_1 \cup \dots \cup F_k$  in  $E(L)$  is uniquely determined by the simplex  $(\sigma_0, \sigma_1, \dots, \sigma_k)$ .*

### 5. Proof of Theorems 2.3 (2) and 3.3

In this section we prove Theorems 2.3 (2) and 3.3 by assuming Theorem 2.3 (1). Let  $(T, w)$  be a finite weighted plane tree, and let  $\rho$  and  $\rho'$  be two elements of  $\mathcal{O}(T)$ . Let  $E(\rho, \rho')$ ,  $V(\rho, \rho')$ ,  $T(\rho, \rho')$ ,  $[\rho]$  and  $[\rho']$  be as in Section 3 (see the paragraph before Lemma 3.5). Put  $L = L(T, w)$ . For each element  $B$  of  $V(\rho, \rho')$ , we have  $\rho|_B = \rho'|_B$ , and we obtain a Seifert surface  $F(B, w; \rho) = F(B, w; \rho')$ . The Seifert surfaces  $F(T, w; \rho)$  and  $F(T, w; \rho')$  for  $L$  are obtained from  $\{F(B, w; \rho)\}_{B \in V(\rho, \rho')}$  by

plumbing according to the data determined by the oriented trees  $(T(\rho, \rho'); [\rho])$  and  $(T(\rho, \rho'); [\rho'])$  respectively. To be more precise, recall the construction of these surfaces;

$$F(T, w; \rho) = (\cup_{v \in V(T)} A(v)) \cup (\cup_{e \in E(T)} D(e; \rho)),$$

$$F(T, w; \rho') = (\cup_{v \in V(T)} A(v)) \cup (\cup_{e \in E(T)} D(e; \rho')),$$

where  $A(v) = cl(F(v) - \cup_{e \in E(v, T)} D(e, v))$  (see Section 2). We may assume each piece in this construction meets the exterior  $E(L)$  “nicely”. In the remainder of this section, we discuss in  $E(L)$ , and refer to the intersection of  $E(L)$  with each piece in the above construction by denoting the same symbol. For each  $B \in V(\rho, \rho')$ , put  $F(B) = (\cup_{v \in B} A(v)) \cup (\cup_{e \in E(B)} D(e; \rho))$ . Then we see

$$F(T, w; \rho) = (\cup_{B \in V(\rho, \rho')} F(B)) \cup (\cup_{e \in E(\rho, \rho')} D(e; \rho)),$$

$$F(T, w; \rho') = (\cup_{B \in V(\rho, \rho')} F(B)) \cup (\cup_{e \in E(\rho, \rho')} D(e; \rho')).$$

We move  $F(T, w; \rho)$  by an isotopy of  $E(L)$  so that it intersects  $F(T, w; \rho')$  transversely and “minimally” according to the following indication: Choose a “base edge”  $e_* \in E(\rho, \rho')$ , and define a sign  $\varepsilon(B)$  for each  $B \in V(\rho, \rho')$  as follows: Let  $e_* = e_0, e_1, \dots, e_k$  be the shortest path in  $T(\rho, \rho')$  joining  $e_*$  and  $B$ . [If  $B$  is an end-point of  $e_*$ , then  $k=0$ .] Define  $\varepsilon(B) = +$  or  $-$  according as  $B$  is the terminal point or the initial point of  $(e_k; \rho)$  (see Figure 5.1).

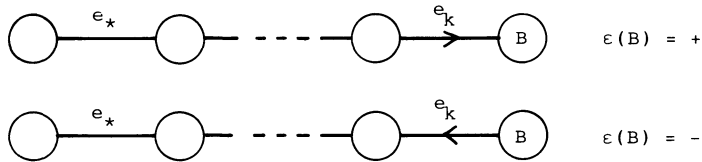

Figure 5.1

For each  $B \in V(\rho, \rho')$ , we move  $F(B)$  in the  $\varepsilon(B)$ -direction of the normal vector to the oriented surface  $F(T, w; \rho)$ , so that they are disjoint from  $F(T, w; \rho')$ . According to this move, we modify  $D(e; \rho)$  ( $e \in E(\rho, \rho')$ ) as indicated in the following: Let  $B_1$  and  $B_2$  be the end-points of  $e$ .

Case 1.  $\varepsilon(B_1) = -\varepsilon(B_2)$ : We may assume  $\varepsilon(B_1) = +$  and  $\varepsilon(B_2) = -$ . Then we see from the definition of  $\varepsilon$  that  $B_1$  and  $B_2$  are the terminal point and the initial point of  $(e; \rho)$  respectively. We can shrink  $D(e; \rho)$  to a subdisk of the original one, so that the new  $F(B_1) \cup D(e; \rho) \cup F(B_2)$  is disjoint from  $F(T, w; \rho)$ . Note that  $cl(\text{old}(D(e; \rho)) - \text{new}(D(e; \rho)))$  is



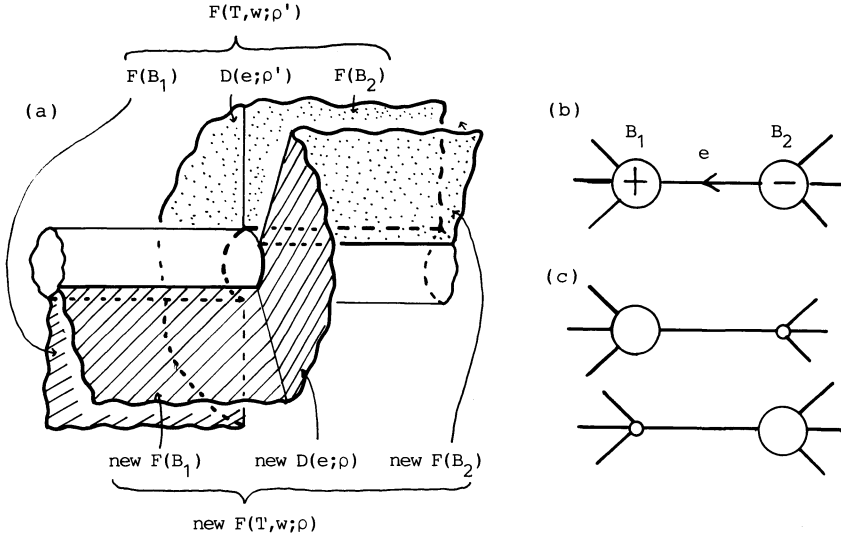

Figure 5.2

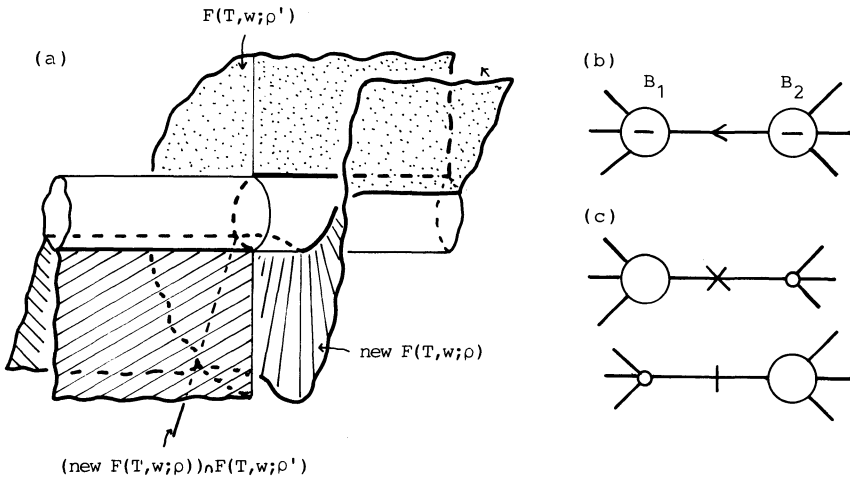

Figure 5.3

the disjoint union of four “product disks”; i.e., each of them meets the new  $F(T, w; \rho)$  [resp.  $F(T, w; \rho')$ ,  $\partial E(L)$ ] in an arc [resp. an arc, two arcs]. Near the 4-Murasugi sphere  $S(e)$ ,  $E(L) - (F(T, w; \rho) \cup F(T, w; \rho'))$  has two closed up components; and each of the them contain two of the above product disks. (See Figure 5.2 (a) and (b), where a neighbourhood

of a component of  $S(e) \cap \partial E(L)$  is depicted.)

Case 2.  $\varepsilon(B_1) = \varepsilon(B_2)$ : We can modify a small neighbourhood of  $D(e; \rho)$  in  $F(T, w; \rho)$  so that it intersects  $F(T, w; \rho')$  transversely in two arcs lying in the 4-Murasugi sphere  $S(e)$ . Near  $S(e)$ ,  $E(L) - (F(T, w; \rho) \cup F(T, w; \rho'))$  has three components; and one of them has the closure that is not a 3-manifold. (See Figure 5.3 (a) and (b).)

We call the above isotopy a *small isotopy*. After a small isotopy,  $F(T, w; \rho)$  intersects  $F(T, w; \rho')$  transversely. The closed up components of  $E(L) - (F(T, w; \rho) \cup F(T, w; \rho'))$  can be described in terms the following trees with distinguished vertex sets and with marks on the edge sets. Let  $B_0$  be the initial point of  $(e_*; \rho)$ , and let  $V_0(\rho, \rho')$  [resp.  $V_1(\rho, \rho')$ ] be the set of the elements of  $V(\rho, \rho')$  which have even [resp. odd] distance from  $B_0$  in the tree  $T(\rho, \rho')$ . For  $i=0,1$ , let  $T_i(\rho, \rho')$  denote the tree  $T(\rho, \rho')$  where the subset  $V_i(\rho, \rho')$  of the vertex set  $V(\rho, \rho')$  is specified. We call a vertex contained in  $V_i(\rho, \rho')$  a *distinguished vertex* of  $T_i(\rho, \rho')$ . We assign a "cut mark" | and a "bad mark"  $\times$  to the above trees according to the following indication: Suppose the end-points of an edge  $e \in E(\rho, \rho')$  have the same sign. If  $e$  has an even [resp. odd] distance from  $B_0$ , then assign a bad mark  $\times$  to the corresponding edge of  $T_0(\rho, \rho')$  [resp.  $T_1(\rho, \rho')$ ], and assign a cut mark | to the corresponding edge of  $T_1(\rho, \rho')$  [resp.  $T_0(\rho, \rho')$ ]. Here the distance between  $B_0$  and  $e$  is defined as the distance between  $B_0$  and the nearest end-point of  $e$  from  $B_0$  in the tree  $T(\rho, \rho')$  (See Figure 5.4, where the distinguished vertices are represented by big circles.)

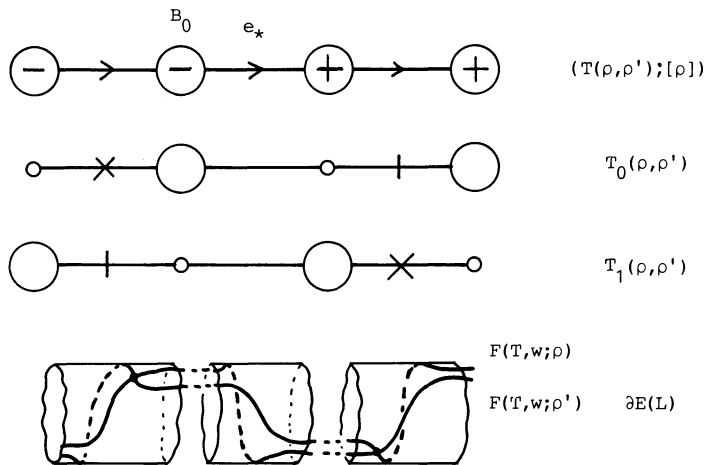

Figure 5.4

**Lemma 5.1.** *There is a bijection  $\mathcal{T}$  between the set  $\mathcal{A}$  of the closed up components of  $E(L(T,w)) - (F(T,w; \rho) \cup F(T,w; \rho'))$  and the set  $\mathcal{B}$  of the connected components of  $\cup_{i=1}^2 (T_i(\rho, \rho') - \{\text{cut marks}\})$ . Further, the structure of a closed up component  $P \in \mathcal{A}$  can be read from the corresponding element  $\mathcal{T}(P) \in \mathcal{B}$  as follows:*

- (1) *If  $\mathcal{T}(P)$  has a bad mark, then  $P$  is not a 3-manifold.*
- (2) *Suppose  $\mathcal{T}(P)$  does not have a bad mark. Put  $R = P \cap F(T,w; \rho)$ ,  $R' = P \cap F(T,w; \rho')$ . Let  $\gamma$  be the 1-submanifold of  $\partial P$  which forms the core of  $\partial P \cap (\partial E(L) \cup (F(T,w; \rho) \cap F(T,w; \rho')))$ . Then  $\gamma$  determines a sutured manifold  $(P, \gamma)$  (in the sense of Conventioin 4.1), such that  $R \subset R_\varepsilon(\gamma)$ ,  $R' \subset R_{-\varepsilon}(\gamma)$  ( $\varepsilon = +$  or  $-$ ), and that there are deformation retracts from  $R_\varepsilon(\gamma)$  to  $R$  and from  $R_{-\varepsilon}(\gamma)$  to  $R'$ . Further  $(P, \gamma)$  has a product decomposition into the disjoint union of a product sutured manifold and the complementary sutured manifolds  $\{(M_B, \gamma_B)\}$  for  $\{F(B,w; \rho)\}$ , where  $B$  runs over all distinguished vertices contained in  $\mathcal{T}(P)$ .*

Proof. The existence of  $\mathcal{T}$  and (1) follow from the construction of  $T_i(\rho, \rho')$ . (See Figure 5.2 (c) and 5.3 (c) for local correspondence, and see Figure 5.4 for the situation on  $\partial E(L)$ ).

(2) follows from the arguments in [8, pp.529–530] (cf. Proposition 4.7) by using the product disks given in Case 1 in the construction of the small isotopy.

**Lemma 5.2.** *Let  $P$  be an element of  $\mathcal{A}$ .*

(1)  *$P$  is a blister between  $F(T,w; \rho)$  and  $F(T,w; \rho')$ , if and only if  $\mathcal{T}(P)$  does not contain a bad mark and  $|w(v)|=1$  for every  $v \in V(T)$  which is contained a distinguished vertex in  $\mathcal{T}(P)$ .*

(2) *Suppose  $P$  is a blister. Then by an isotopy through  $P$ ,  $F(T,w; \rho)$  is equivalent to  $F(T,w; \rho'')$ , where  $\rho''$  is the orientation of  $T$  obtained from  $\rho$  by reversing the orientations of the edges  $e \in E(\rho, \rho')$  which are incident to the distinguished vertices in  $\mathcal{T}(P)$ .*

(3) *In the above,  $\rho''$  is related to  $\rho$  by an iteration of finite number of elementary operations.*

Proof. (1)  $P$  is a blister if and only if  $(P, \gamma)$  is a product sutured manifold. By Lemma 5.1 and by [8, Lemma 2.2], this is equivalent to the condition that (i)  $\mathcal{T}(P)$  does not contain a bad mark, and (ii) for every distinguished vertex  $B$  in  $\mathcal{T}(P)$ ,  $(M_B, \gamma_B)$  is a product sutured manifold. By [5, Theorem 3] (cf. [8, Lemma 2.4]),  $(M_B, \gamma_B)$  is a product sutured manifold, if and only if  $|w(v)|=1$  for any vertex  $v$  of  $B$ . Thus we obtain the desired result.

(2) Moving  $F(T,w; \rho)$  through  $P$  amounts to replacing  $D(e; \rho)$  with

$D(e; -\rho)$  for every edge  $e(\in E(\rho, \rho'))$  which is incident to a distinguished vertex contained in  $\mathcal{T}(P)$ , Thus we obtain the desired result.

(3) We prove this assertrion by using Remark 3.6 (2). Let  $B$  be a distinguished vertex in  $\mathcal{T}(P)$ , and let  $e_* = e_0, e_1, \dots, e_k$  be the shortest path in  $T(\rho, \rho')$  joining  $e_*$  and  $B$ . Suppose  $B$  is not positive nor negative. Then there is an edge  $e_{k+1}$  incident to  $B$  such that the terminal points of  $(e_k; [\rho])$  and  $(e_{k+1}; [\rho])$  are different. By the definition of  $\varepsilon$ , the signs of the end-points of  $e_{k+1}$  are equal. On the other hand, the distance between  $B_0$  and  $B$  is equal to the distance between  $B_0$  and  $e_{k+1}$ . Hence the edge  $e_{k+1}$  in  $\mathcal{T}(P)$  must have a bad mark, a contradiction. Hence any distinguished vertex in  $\mathcal{T}(P)$  is positive or negative. By using the fact that  $\mathcal{T}(P)$  has no bad marks and the fact that any pair of distinguished vertices in  $\mathcal{T}(P)$  has an even mutual distance, we can see that either all the distinguished vertices in  $\mathcal{T}(P)$  are positive or otherwise negative. Hence, by (1), (2), and remark 3.6 (2), we obtain the desired result.

Now we are in a position to prove Theorem 2.3 (2) and Theorem 3.3

Proof of Theorem 2.3 (2). By applying a small isotopy, we may suppose  $F(T, w; \rho)$  and  $F(T, w; \rho')$  intersect as described in Lemma 5.1. Suppose these two surfaces are equivalent. Then there is a blister  $P$  between these two surfaces by Proposition 4.8 (1). By Lemma 5.2,  $F(T, w; \rho)$  is equivalent to  $F(T, w; \rho'')$  via an isotopy through  $P$ , where  $\rho''$  is related to  $\rho$  by a finite sequence of elementary operations. If  $|F(T, w; \rho) \cap F(T, w; \rho')| = 0$ , then we have  $\rho'' = \rho'$ ; otherwise we have  $|F(T, w; \rho'') \cap F(T, w; \rho')| < |F(T, w; \rho) \cap F(T, w; \rho')|$  after a small isotopy. Thus, by repeating this process, we see  $\rho$  and  $\rho'$  are related by a finite sequence of elementary operations. This completes the proof of Theorem 2.3 (2).

Proof of Theorem 3.3 assuming Theorem 2.3 (1). By virtue of Proposition 4.9 (1), we have only to show that  $F(T, w; \rho)$  and  $F(T, w; \rho')$  can be made disjoint in  $E(L)$  if and only if there is a simplex in  $\mathcal{K}(T, w)$  containing both  $p(\rho)$  and  $p(\rho')$  as vertices, where  $p$  is the projection  $\mathcal{K}(T) \rightarrow \mathcal{K}(T, w)$ . We prove the “only if” part of this assertion. Suppose  $F(T, w; \rho)$  and  $F(T, w; \rho')$  can be made disjoint in  $E(L)$ . Then by an argument parallel to the proof of Theorem 2.3 (2) (using Proposition 4.8 (2) instead of Proposition 4.8 (1)), we can see that there is an element  $\rho^*$  of  $\mathcal{O}(T)$  such that  $p(\rho^*) = p(\rho)$  and the orientation  $[\rho^*]$  on  $T(\rho^*, \rho')$  is alternating. By Lemma 3.5, there is a cycle in  $\mathcal{O}(T)$  containing  $\rho^*$  and  $\rho$ . This cycle determines the desired simplex in  $\mathcal{K}(T, w)$ . The “if”

part easily follows from Lemma 5.1.

At the end of this section, we present a consequence of Theorem 3.3, which is used in Section 8. We say that two vertices  $\sigma_1$  and  $\sigma_2$  of  $MS(L)$  [resp.  $IS(L)$ ] are *adjacent*, if the following condition is satisfied: There are representatives  $F_1$  and  $F_2$  of  $\sigma_1$  and  $\sigma_2$  respectively which are mutually disjoint in  $E(L)$ , such that one of the closed up component of  $E(L) - (F_1 \cup F_2)$  contains no minimal genus [resp. incompressible] Seifert surfaces for  $L$  except those surfaces that are isotopic to  $F_1$  or  $F_2$ . By virtue of Theorem 3.3 and Proposition 4.9 (2), we can determine the pairs of vertices of  $MS(L(T,w))$  which are adjacent. In particular we obtain the following.

**Proposition 5.3.** *Suppose  $w$  is a special weight on  $T$ . Then, two vertices  $[F(T,w; \rho)]$  and  $[F(T,w; \rho')]$  of  $MS(L(T,w))$  are adjacent if and only if  $v(\rho) = \rho'$  for some vertex  $v$  of  $T$  which is positive or negative with respect to  $\rho$ .*

**6. Proof of Theorem 2.3 (1)**

Let  $(T,w)$  be a finite weighted plane tree, and put  $L = L(T,w)$ . By Lemma 3.4,  $\mathcal{O}(T)$  has a cycle

$$\rho_0 \xrightarrow{v_0} \rho_1 \xrightarrow{v_1} \cdots \rightarrow \rho_n \xrightarrow{v_n} \rho_0.$$

Put  $F_i = F(T,w; \rho_i)$ . The following assertion follows from the proof of Theorem 3.3.

**Assertion 6.1.** *After small isotopies, the following holds:*

(1)  $F_0, F_1, \dots, F_n$  are mutually disjoint in  $E(L)$ , and they are situated in  $E(L)$  in this cyclic order.

(2) For each  $i$  ( $0 \leq i \leq n$ ), let  $(E_i, \delta_i)$  be the sutured manifold between  $F_i$  and  $F_{i+1}$ . Then it has a product decomposition into the disjoint union of the complementary sutured manifold  $(M_{v_i}, \gamma_{v_i})$  for the twisted band  $F(v_i)$  and a product sutured manifold. Here the suffix is considered with modulo  $n+1$ .

Let  $v$  be an element of  $V(T)$ , and let  $k$  be the integer such that  $v = v_k$ . Then  $M_v$  is embedded in  $E_k \subset E(L)$  by Assertion 6.1 (2). Let  $\mu_v$  denote a circle embedded in  $E(L)$  which forms a core of the solid torus  $M_v$ . Note that  $\mu_v$  is also a core of the solid torus  $cl(S^3 - N(A(v) \cup (\cup_{e \in E(v,T)} B^3(e,v))))$ , where  $B^3(e,v)$  is the 3-ball bounded by  $S(e)$  whose interior is disjoint from  $A(v)$  (cf. Figure 8.1 (a)). Since any  $F(T,w; \rho)$



To be more precise, let  $\mathcal{D}$  be the union of the product disks in  $(E_{[r]}, \delta_{[r]})$  which decompose  $(E_{[r]}, \delta_{[r]})$  into the disjoint union of a product sutured manifold, say  $(P, \delta)$ , and  $(M_v, \gamma_v)$  with  $v = v_{[r]}$  (cf. Assertion 6.1 (2)). We may suppose  $F$  intersects  $\mathcal{D}$  transversely. Note that  $E(L)$  is irreducible since  $L$  has a connected minimal genus Seifert surface. Thus we may suppose  $F \cap \mathcal{D}$  does not contain loop components. By an isotopy of  $E(L)$  whose support is contained in a small neighbourhood of  $\mathcal{D}$ , we may suppose no (arc) component of  $F \cap \mathcal{D}$  has both end-points in  $R_-(\gamma_{[r]}) = F_{[r]}$  (see Figure 6.1 (b)). Then any component  $G$  of  $F \cap E_{[r]}$ , whose boundary is contained in  $F_{[r]}$ , is contained in either  $P$  or  $M_v$ . By the minimality of  $F$  and the irreducibility of  $E(L)$ , we may suppose  $G$  is incompressible and is not a disk. If  $G \subset P$ , then  $G$  is parallel to a subsurface in  $R_-(\delta)$ , and therefore we can delete the component  $G$  from  $F \cap E_{[r]}$  by an isotopy. If  $G \subset M_v$ , then  $G$  is an annulus since  $\pi_1(M_v) \cong \mathbf{Z}$ . Let  $G'$  a sub-annulus in  $R_-(\gamma_v)$  with  $\partial G' = \partial G$ . Then either  $G$  is parallel to  $G'$  or  $G \cup G'$  bounds a solid torus in  $M_v$  whose core is isotopic to  $\mu_v$ . Thus we can delete the component  $G$  from  $F \cap E_{[r]}$  by an isotopy or by a series of annulus modifications at  $v$  (see Figure 6.1 (c)). By repeating the above process, we obtain a surface  $F'$  from  $F$  through isotopies and annulus modifications at  $v$  such that, for any component  $G$  of  $F' \cap E_{[r]}$ ,  $\partial G$  is not contained in  $F_{[r]}$ . From the construction, we can see that  $r(F') \leq r - 1$  and  $s(F') \geq s(F)$ . Thus we obtain the desired result by repeating the above process.

By using [16, Proposition 2.6], we see any minimal genus Seifert surface for  $L$  which is disjoint from  $\cup_{i=0}^n F_i$  is isotopic to  $F_i = F(T, w; \rho_i)$  for some  $i$ . Thus we have only to show the following assertion to prove Theorem 2.3 (1).

**Assertion 6.3.** *Let  $\rho$  be an element of  $\mathcal{O}(T)$ ,  $F = F(T, w; \rho)$ , and  $v_*$  a vertex of  $T$ . Then any Seifert surface for  $L$  obtained from  $F$  through an annulus modification at  $v_*$  is equivalent to  $F(T, w; \rho')$  for some  $\rho' \in \mathcal{O}(T)$ .*

If  $|w(v_*)| = 1$ , then  $(M_{v_*}, \gamma_{v_*})$  is a product sutured manifold, and therefore any annulus modification at  $v_*$  does not change the isotopy type of a Seifert surface. Thus we assume  $|w(v_*)| \geq 2$  in the following. Then we have;

**Lemma 6.4.** *Let  $F'$  be a surface in  $E(L)$  isotopic to  $F$ , and suppose  $F'$  is also disjoint from  $\mu_{v_*}$ . Then  $F'$  is isotopic to  $F$  by an isotopy of  $E(L)$  which preserves  $\mu_{v_*}$ .*

Proof. For  $\varepsilon = \pm$ , let  $j_\varepsilon: H_1(F; \mathbf{Z}) \rightarrow H_1(E(L) - F; \mathbf{Z})$  be the homomorphism defined by pushing each cycle in the  $\varepsilon$ -direction of the normal vector to  $F$ . Then we see  $[\mu_{v_*}]$  is not contained in  $Im(j_\varepsilon)$  since  $|w(v_*)| \geq 2$ . Thus  $\mu_{v_*}$  is not homotopic in  $E(L)$  to a loop in  $F$ . We may suppose  $F$  and  $F'$  are in general position and the number  $|F \cap F'|$  is minimal among all surfaces isotopic to  $F'$  preserving  $\mu_{v_*}$ . Since  $F'$  is isotopic to  $F$ , there is a blister  $P$  between  $F$  and  $F'$  by Proposition 4.8 (1). By the above fact,  $\mu_{v_*}$  is not contained in  $P$ . If  $|F' \cap F|$  is not 0, then we can decrease it by an isotopy through  $P$  preserving  $\mu_{v_*}$ , a contradiction. So  $F \cap F' = \emptyset$ , and  $P$  gives a parallel region between  $F$  and  $F'$ . Hence there is an isotopy of  $E(L)$  preserving  $\mu_{v_*}$  which sends  $F'$  to  $F$ .

Let  $(M, \gamma)$  be the complementary sutured manifold for  $F$ . Then we have  $\mu_{v_*} \subset \text{int} M$ ; further, by the above lemma, the location of  $\mu_{v_*}$  in  $M$  is unique up to isotopy. Let  $W$  be a fixed regular neighbourhood of  $\mu_{v_*}$  in  $M$ . Then the annulus modifications at  $v$  are related to the following condition.

CONDITION 6.5. There is an annulus  $A$  properly embedded in  $cl(M - W)$  such that a component of  $\partial A$  is an essential loop in  $\partial W$  and the other component of  $\partial A$  is contained in  $R_-(\gamma)$ .

If this condition is satisfied, then we can perform a (+)-annulus modification at  $v_*$  to  $F$  as illustrated in Figure 6.2. More precisely, the surface obtained from  $F$  by the annulus modification is isotopic to  $Fr(N(R_-(\gamma) \cup A \cup W))$ , where  $N$  and  $Fr$  denote the regular neighbourhood and the frontier in  $M$  respectively. Conversely, any annulus modification of  $F$  at  $v$  is obtained in this way. If we interchange the signs  $+$  and  $-$  in the above, then we obtain the corresponding results for (-)-annulus modifications.

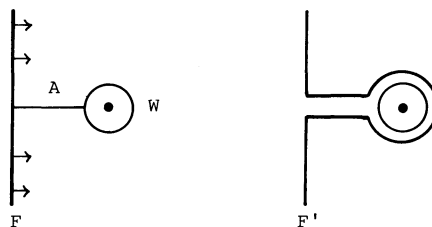

Figure 6.2



**Lemma 6.6.** *We can perform a (+)-annulus modification at  $v_*$  to  $F = F(T, w; \rho)$  if and only if the following condition is satisfied: Let  $T^+(v_*, \rho)$  be the subtree of  $T$  spanned by the vertices  $v$  of  $T$ , such that any edge contained in the (shortest) path from  $v_*$  to  $v$  is oriented by  $\rho$  so that it points to  $v$  (see Figure 6.3); then, for any vertex  $v$  of  $T^+(v_*, \rho)$  except  $v_*$ , the identity  $|w(v)| = 1$  holds.*

*Further, if this condition is satisfied, then there is a “unique” (+)-annulus modification of  $F$  at  $v_*$ . Similar results also hold for (-)-annulus modifications.*

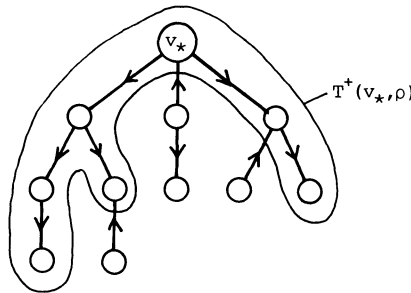

Figure 6.3

**Proof.** First, we show the “if” part. Suppose that the assumption in the lemma is satisfied. Recall that  $(M, \gamma)$  is obtained from the disjoint union of  $\{(M_v, \gamma_v)\}_{v \in V(T)}$  through identification along  $\mathcal{Q} = \cup_{e \in E(T)} Q(e)$  (see example 4.3). Consider the annulus  $A^*$  in  $cl(M_{v_*} - W)$  and the disk  $\Delta(v)$  in  $M_v$  for each  $v \in V(T^+(v_*, \rho)) - \{v_*\}$  as illustrated in Figure 6.4.

Note that the following holds:

(1) A component of  $\partial A^*$  is an essential loop in  $\partial W$  and the other component, say  $C$ , of  $\partial A^*$  is contained in  $R_-(\gamma_{v_*})$ . Let  $e$  be an element of  $E(v_*, T)$ . If  $e$  is contained in  $T^+(v_*, \rho)$ , then  $C \cap Q(e)$  is a horizontal mark for  $Q(e)$  in  $(M_{v_*}, \gamma_{v_*})$ ; otherwise  $C \cap Q(e) = \emptyset$ .

(2) For each  $v \in V(T^+(v_*, \rho)) - \{v_*\}$ ,  $\Delta(v)$  is a meridian disk of the solid torus  $M_v$  which intersects  $R_+(\gamma_v)$  in an arc. [Here we use the condition  $|w(v)| = 1$ .] Let  $e$  be an element of  $E(v, T)$ . Suppose  $e$  is contained in  $T^+(v_*, \rho)$ . Then  $\partial \Delta(v) \cap Q(e)$  is a vertical mark or a horizontal mark for  $Q(e)$  in  $(M_v, \gamma_v)$  according to whether  $e$  is contained in the path from  $v_*$  to  $v$  or not. If  $e$  is not contained in  $T^+(v_*, \rho)$ , then  $\partial \Delta(v) \cap Q(e) = \emptyset$ .

Thus we can construct an annulus  $A$  in  $cl(M - W)$  by piecing  $A^*$  and  $\Delta(v)$  ( $v \in V(T^+(v_*, \rho)) - \{v_*\}$ ) together. We can see that  $A$  is an

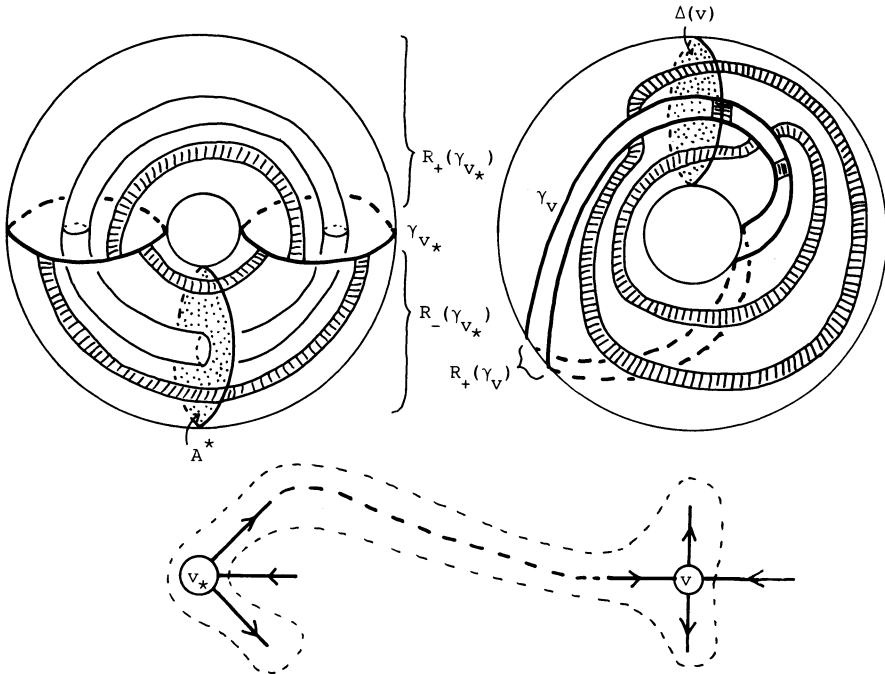

Figure 6.4

annulus required by Condition 6.5, and hence, we obtain the “if” part.

Next, we show the “only if” part and the uniqueness of the annulus modification. Suppose we can perform a (+)-annulus modification at  $v_*$  to  $F = F(T, w; \rho)$ , and let  $A$  be the corresponding annulus in  $cl(M - W)$  required by Condition 6.5. We show that  $A$  is  $\gamma$ -isotopic to the annulus constructed in the proof of the “if” part.

Step 1. Let  $C^*$  and  $C^-$  be the components of  $\partial A$  lying in  $\partial W$  and  $R_-(\gamma)$  respectively. We may suppose  $A$  intersects the union of 4-gons  $\mathcal{Q} = \cup_{e \in E(T)} Q(e)$  transversely, and the number  $|A \cap \mathcal{Q}|$  is minimized. By the incompressibility of  $A$  and the irreducibility of  $M$ ,  $A \cap \mathcal{Q}$  contains no loop components. Note that the boundary of any component of  $A \cap \mathcal{Q}$  lies in  $C^-$ , since  $\mathcal{Q}$  is disjoint from  $W$ . By using the incompressibility of  $R_-(\gamma)$  and the irreducibility of  $M$ , we see that each component of  $A \cap Q(e)$  is an arc in  $Q(e)$  joining the two components of  $\partial Q(e) \cap R_-(\gamma)$ .

Step 2. Suppose  $A \cap \mathcal{Q} \neq \emptyset$ . Let  $\alpha$  be an outermost component of  $A \cap \mathcal{Q}$  in  $A$ , and let  $e$  be the edge of  $T$  such that  $\alpha \subset Q(e)$ . Then  $\alpha$  cuts off a disk, say  $\Delta$ , in  $A$ , which forms a properly embedded disk in some  $M_v$ . Note that  $\partial \Delta \subset R_-(\gamma_v) \cup Q(e)$ ,  $\partial \Delta \cap Q(e) = \alpha$ , and  $\alpha$  is either a horizontal mark or a vertical mark for  $Q(e)$  in  $(M_v, \gamma_v)$ . If  $\alpha$  is a horizontal

mark, then  $\alpha \cap \gamma_v = \emptyset$ , and hence,  $\partial \Delta \subset R_-(\gamma_v)$ ; so  $\partial \Delta$  bounds a disk in  $R_-(\gamma)$ . This contradicts the condition  $\partial \Delta \cap Q(e) = \alpha$ . Hence,  $\alpha$  is a vertical mark. Then we see that  $Q(e) \subset R_+(\gamma_v)$  and that  $\partial \Delta$  intersects  $R_+(\gamma_v)$  in an essential arc. Hence  $v$  is the terminal point of  $(e; \rho)$  and  $|w(v)| = 1$ .

Step 3. Suppose  $A \cap \mathcal{Q}$  contains a component which is not outermost in  $A$ . Let  $\alpha$  be a component of  $A \cap \mathcal{Q}$  which is next to a set of outermost components, say  $\beta_1, \dots, \beta_k$ , and let  $\Delta$  be the disk in  $A$  cut off by  $\alpha \cup \beta_1 \cdots \cup \beta_k$  (see Figure 6.5 (a)). Then  $\Delta$  forms a properly embedded disk in some  $M_v$ . Let  $e_0$  and  $e_i$  ( $1 \leq i \leq k$ ) be the edges of  $T$  such that  $\alpha \subset Q(e_0)$  and  $\beta_i \subset Q(e_i)$ . Then by the Step 2,  $\beta_i$  is a horizontal mark for  $Q(e_i)$  in  $(M_v, \gamma_v)$ . Suppose  $\alpha$  is a horizontal mark for  $Q(e_0)$  in  $(M_v, \gamma_v)$ . Then  $\partial \Delta$  is contained in  $R_-(\gamma_v)$ , and hence, it bounds a disk, say  $\Delta'$ , in  $R_-(\gamma_v)$ . We can find a subdisk  $\sigma$  in  $\Delta'$ , such that  $\partial \sigma$  is the union of two arcs  $\zeta$  and  $\xi$ , where  $\zeta$  is a subarc of  $\partial \Delta$  such that  $\zeta \cap (\cup_{i=0}^k Q(e_i)) = \partial \zeta$ , and  $\xi$  is a subarc of  $\partial Q(e_i) - \gamma_v$  for some  $i$  ( $0 \leq i \leq k$ ) (see Figure 6.5 (b)).

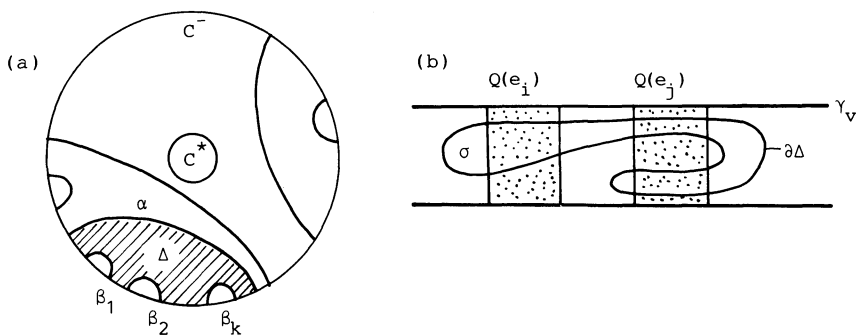

Figure 6.5

By using this disk, we can decrease the number  $|A \cap \mathcal{Q}|$ , a contradiction. Hence,  $\alpha$  is a vertical mark. So we see that  $Q(e_0) \subset R_+(\gamma_v)$  and that  $\partial \Delta$  intersects  $R_+(\gamma_v)$  in an essential arc. Thus we see  $|w(v)| = 1$ . Note that  $e_0$  [resp.  $e_i$  ( $1 \leq i \leq k$ )] is oriented by  $\rho$  so that  $v$  is the terminal [resp. initial] point.

Step 4. By repeating the above arguments, we obtain the following:

(1) Let  $\alpha$  be a component of  $A \cap \mathcal{Q}$ ,  $e$  the edge of  $T$  such that  $\alpha \subset Q(e)$ ,  $\tilde{\Delta}$  a disk in  $A$  cut off by  $\alpha$ , and  $v$  [resp.  $v'$ ] the end-point of  $e$  such that  $M_v$  [resp.  $M_{v'}$ ] contains a neighbourhood of  $\alpha$  in  $\tilde{\Delta}$  [resp. in  $cl(A - \tilde{\Delta})$ ]; then  $|w(v)| = 1$  and  $v$  is the terminal point of  $(e; \rho)$ .

(2) Let  $A^*$  be the closed up component of  $A - (A \cap \mathcal{Q})$  containing the boundary loop  $C^*$ . Then  $A^*$  is a properly embedded annulus in

$cl(M_{v_*} - W) (\cong T^2 \times I)$ , such that  $\partial A^* \cap \partial W = C^*$ . Further, for  $e \in E(v_*, T)$ ,  $Q(e)$  intersects  $C = \partial A^* - C^*$  only if  $v_*$  is the initial point of  $(e; \rho)$ ; and in this case  $C \cap Q(e)$  consists of horizontal marks for  $Q(e)$  in  $(M_{v_*}, \gamma_{v_*})$ .

Thus  $C$  is disjoint from  $\gamma_{v_*}$ , and hence it is contained in  $R_-(\gamma_{v_*})$ . Since  $C^*$  is an essential loop in  $\partial W$ ,  $C$  is an essential loop in  $R_-(\gamma_{v_*})$ . Hence  $C$  intersects  $Q(e)$  if and only if  $v_*$  is the initial point of  $(e; \rho)$ . Now the “only if” part of the lemma can be deduced from the facts listed in the above. To show the uniqueness, we continue the argument.

Step 5. By the minimality of  $|A \cap \mathcal{Q}|$ , we can see that, for each  $e \in E(v_*, T^+(v_*, \rho))$ ,  $C \cap Q(e)$  consists of only one arc. Now we can see that  $A^*$  is isotopic to the  $A^*$  in the proof of the “if” part by an isotopy of  $(cl(M_{v_*} - W), \gamma_{v_*})$  preserving  $\partial M_{v_*} \cap \mathcal{Q}$ . Similarly for each  $v \in V(T^+(v_*, \rho)) - \{v_*\}$ ,  $A \cap M_v$  is isotopic to  $\Delta(v)$  by an isotopy of  $(M_v, \gamma_v)$  preserving  $\mathcal{Q} \cap \partial M_v$ . This proves the uniqueness of the annulus  $A$  satisfying Condition 6.5.

Now the proof of Assertion 6.3 is completed as follows. Suppose a surface  $F'$  is obtained from  $F = F(T, w; \rho)$  by an annulus modification at a vertex  $v_*$  with  $|w(v_*)| \geq 2$ . Then the condition in Lemma 6.6 is satisfied. Let  $T_1, \dots, T_r$  be the components of the sub-forest of  $T$  spanned by  $V(T) - V(T^+(v_*, \rho))$ , and let  $e_i$  be the edge of  $T$  joining  $T^+(v_*, \rho)$  and  $T_i$  ( $1 \leq i \leq r$ ). Then  $(e_i; \rho)$  points to  $T^+(v_*, \rho)$ . Thus, by Lemma 2.1, the Murasugi spheres  $S(e_1), \dots, S(e_r)$  for  $F$  are composable, and the dual surface  $F''$  of  $F$  with respect to the resulting Murasugi sphere is equivalent to  $F(T, w; \rho')$ , where  $\rho'$  is obtained from  $\rho$  by reversing the orientations of  $e_1, \dots, e_r$ . The above Murasugi sphere decomposes  $F$  into  $F_1 = F(T^+(v_*, \rho), w; \rho)$  and a surface  $F_2$  which is a boundary connected sum of  $\{F(T_i, w; \rho)\}_{1 \leq i \leq r}$ . Since  $|w(v)| = 1$  for any  $v \in V(T^+(v_*, \rho)) - \{v_*\}$ , the complementary sutured manifold for  $F_1$  has a product decomposition into the disjoint union of  $(M_{v_*}, \gamma_{v_*})$  and a product sutured manifold. Hence, by Proposition 4.7, the sutured manifold between  $F$  and  $F''$  has a product decomposition into  $(M_{v_*}, \gamma_{v_*})$  and a product sutured manifold. This implies that  $F''$  is obtained from  $F$  by a (+)-annulus modification at  $v_*$ . By the uniqueness of the annulus modification proved by Lemma 6.6, we see  $F'$  is equivalent to  $F''$ . This completes the proof of Assertion 6.3. Now the proof of Theorem 2.3 (1) is complete.

### 7. Proof of Theorem 2.4

Let  $L = L(T, w)$  be a very special arborescent link, and consider a minimal genus Seifert surface  $F = F(T, w; \rho)$  for  $L$ . Let  $(M, \gamma)$  [resp.  $(N, \delta)$ ] be the complementary [resp. product] sutured manifold for  $F$ . As

in the previous section, we use the construction of  $(M, \gamma)$  as the union of  $\{(M_v, \gamma_v)\}_{v \in V(T)}$  along  $\mathcal{Q} = \cup_{e \in E(T)} Q(e)$ . By Proposition 4.4 and Remark 4.6, we have only to classify, up to  $\gamma$ -isotopy, the essential 4-gons  $E$  in  $(M, \gamma)$  such that  $\partial E$  bounds a disk in  $N$ . Note that such 4-gons are separating in  $M$ .

**Lemma 7.1.** *Let  $E$  be a separating essential 4-gon in  $(M, \gamma)$ . Then by a  $\gamma$ -isotopy,  $E$  can be made disjoint from  $\mathcal{Q}$ .*

*Proof.* After a  $\gamma$ -isotopy, we may suppose  $E$  intersects  $\mathcal{Q}$  transversely and  $\partial E$  is disjoint from  $\partial \mathcal{Q} \cap \gamma$ . Suppose we have minimized  $|E \cap \mathcal{Q}|$ , and suppose  $|E \cap \mathcal{Q}| \neq 0$ . Since  $M$  is irreducible,  $E \cap \mathcal{Q}$  does not contain a loop component. Let  $\alpha$  be a component of  $E \cap \mathcal{Q}$  that is outermost in  $E$ . Let  $\Delta$  be a sub-disk of  $E$  such that  $\Delta \cap \mathcal{Q} = \alpha$ , and put  $\beta = cl(\partial \Delta - \alpha)$ . Since  $|E \cap \gamma| = 4$ , we may suppose, if necessary by choosing different outermost arc, that  $|\beta \cap \gamma| \leq 2$ . Let  $e$  be the edge of  $T$  such that  $\alpha \subset Q(e)$ , and let  $v$  be the vertex of  $T$  such that  $\Delta \subset M_v$ . Then  $\beta$  is a properly embedded arc in  $cl(\partial M_v - \mathcal{Q})$  with  $\partial \beta \subset \partial Q(e)$ . By the minimality of  $|E \cap \mathcal{Q}|$  and the fact that  $E$  is essential, we see  $\beta$  is “essential” in  $(cl(\partial M_v - \mathcal{Q}), cl(\gamma_v - \mathcal{Q}))$ ; that is, there is no disk  $\sigma$  in  $cl(\partial M_v - \mathcal{Q})$  such that  $\partial \sigma$  is the union of two arcs  $\xi$  and  $\zeta$ , and one of the following conditions is satisfied:

- (1)  $\xi \subset \beta$  and  $\sigma \cap cl(\gamma - \mathcal{Q}) = \partial \sigma \cap cl(\gamma - \mathcal{Q}) = \zeta$  (see Figure 7.1 (a)).
- (2)  $\xi = \beta$ ,  $\zeta \subset \partial Q(e)$ , and  $\sigma \cap cl(\gamma - \mathcal{Q})$  consists of (zero, one, or two) properly embedded arcs in  $\sigma$  each of which joins  $\xi$  and  $\zeta$  (see Figure 7.1 (b)).

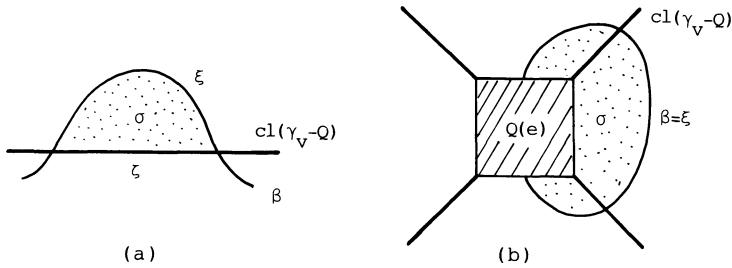

Figure 7.1

**Claim 7.2.**  $|\beta \cap \gamma| = 2$  and  $\alpha$  is a vertical mark for  $Q(e)$  in  $(M_v, \gamma_v)$ .

*Proof.* Since  $|\partial \Delta \cap \gamma_v| \leq |\beta \cap \gamma| + |\partial \alpha \cap \gamma_v| \leq 2 + 2 = 4$ , we see  $\Delta$  is a 0-gon, a 2-gon, or a 4-gon in  $(M_v, \gamma_v)$ .

Case 1.  $\Delta$  is an inessential disk in the solid torus  $M_v$ : Then, by

using the fact that  $\beta$  is “essential” in the above sense, we can see that  $\Delta$  is a 4-gon in  $(M_v, \gamma_v)$ , and  $\partial\Delta$  is situated in  $\partial M_v$  as illustrated in Figure 7.2 (a).

Case 2.  $\Delta$  is a meridian disk of  $M_v$ : Then we see  $2|w(v)| \leq |\partial\Delta \cap \gamma_v| \leq 4$ . Since  $|w(v)| \geq 2$  by the assumption, we see  $|w(v)| = 2$  and  $|\partial\Delta \cap \gamma_v| = 4$ . Thus is as illustrated in Figure 7.2 (b).

In both cases we obtain the desired result.

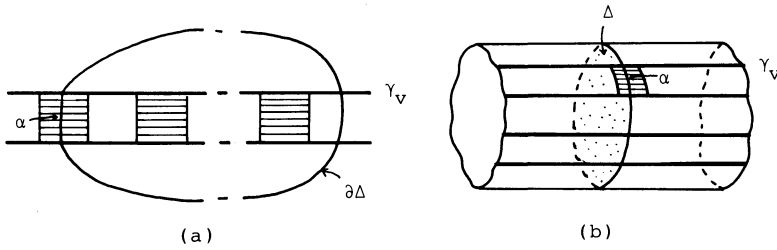

Figure 7.2

By the above claim, we see that  $E \cap \mathcal{Q}$  consists of arcs which are isotopic to each other in  $(E, \gamma \cap \partial E)$ . Let  $\Delta'$  be the closed up component of  $E - \mathcal{Q}$  that is adjacent to  $\Delta$ . Then  $\Delta \cap \Delta' = \alpha$ , and one of the following holds:

- (1)  $(\Delta' \cap \mathcal{Q}) - \alpha$  is an arc, say  $\alpha'$ , and  $\Delta' \cap \gamma = \emptyset$  (see Figure 7.3(a)).
- (2)  $E = \Delta \cup \Delta'$  (see Figure 7.3 (b)).

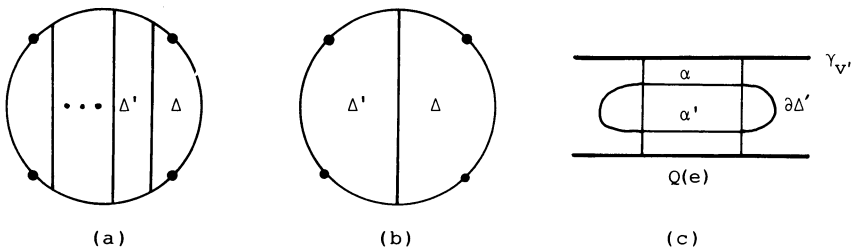

Figure 7.3

Let  $v'$  be the vertex of  $e$  opposite to  $v$ . Then  $\Delta' \subset M_{v'}$ . Since  $\alpha$  is a vertical mark for  $Q(e)$  in  $(M_v, \gamma_v)$ , it is a horizontal mark for  $Q(e)$  in  $(M_{v'}, \gamma_{v'})$ . Hence (2) does not occur by Claim 7.2. Thus we have the conclusion (1). Note that  $|\partial\Delta' \cap \gamma_{v'}| = |\partial\alpha' \cap \gamma_{v'}| \leq 2$ . Thus, using the assumption that  $|w(v')| \geq 2$ , we see that  $\partial\Delta' \cap \gamma_{v'} = \emptyset$  and that  $\partial\Delta'$  is as illustrated in Figure 7.3 (c). This contradicts the minimality of

$|E \cap \mathcal{Q}|$ . Hence we have  $|E \cap \mathcal{Q}| = 0$ , completing the proof of Lemma 7.1.

Proof of Theorem 2.4. Let  $S$  be an essential 4-Murasugi sphere for  $F = F(T, w; \rho)$ , and let  $E$  be the essential 4-gon in  $(M, \gamma)$  corresponding to  $S$ . By Lemma 7.1, we may suppose  $E$  is disjoint from  $\mathcal{Q}$ . Let  $v$  be a vertex of  $T$  such that  $E \subset M_v$ . Since  $E$  separates  $M$ ,  $\partial E$  bounds a disk, say  $\tilde{E}$ , in  $\partial M_v$ . Since  $|\partial E \cap \gamma_v| = 4$ ,  $\tilde{E} \cap \gamma_v$  consists of two arcs. Let  $\Delta$  be the closed up component of  $\tilde{E} - \gamma_v$  whose boundary contains both of the components of  $\tilde{E} \cap \gamma_v$ . Since  $E$  is an essential 4-gon in  $(M, \gamma)$ , we see  $\mathcal{Q} \cap \tilde{E} = \mathcal{Q} \cap \Delta$  is a nonempty union  $Q(e_1) \cup \dots \cup Q(e_r)$ , where  $\{e_1, \dots, e_r\}$  is a certain subset of  $E(v, T)$  (see Figure 7.4 (a)). Suppose  $Q(e_1), \dots, Q(e_r)$  lies in  $\Delta$  in this order. Then  $\{e_1, \dots, e_r\}$  lies successively in this order around  $v$ , and they are oriented by  $\rho$  so that  $v$  is the terminal point or the initial point according as  $\Delta$  lies in  $R_+(\gamma_v)$  or  $R_-(\gamma_v)$ . Thus we can express the 4-gon  $E$  by an arc  $\alpha$  in a small circle in  $\mathbf{R}^2$  around  $v$ , such that  $T \cap \alpha = T \cap \text{int}(\alpha)$  consists of  $k$  points from each of  $e_1, \dots, e_k$  (see Figure 7.4 (b)).

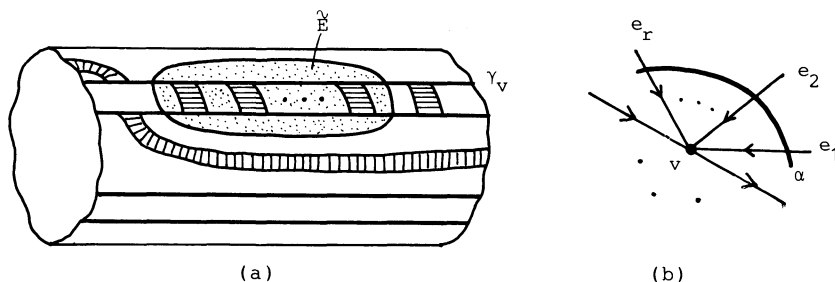

Figure 7.4

The  $\gamma$ -isotopy class of  $E$  is determined by the ordered set  $(e_1, \dots, e_r)$ . Hence it is determined by the isotopy class of  $\alpha$  in  $(\mathbf{R}^2, T)$ . This completes the proof of Theorem 2.4.

Note that a 4-Murasugi sphere in Example 2.2 (1) decomposes the link into two prime links, if and only if it is equivalent to  $S(e)$  for some  $e \in E(T)$ . Thus we obtain the following corollary, which is used in the next section to prove Theorems 2.6 and 2.7.

**Corollary 7.3.** *For a minimal genus Seifert surface  $F(T, w; \rho)$  of a very special arborescent link  $L(T, w)$ , the set of the 4-Murasugi spheres  $\{S(e)\}_{e \in E(T)}$  is “characteristic”; that is, for any self-homeomorphism  $g$  of the pair  $(S^3, F(T, w; \rho))$ , the 4-Murasugi sphere  $g(S(e))$ , where  $e$  is an arbitrary*

element of  $E(T)$ , is equivalent to  $S(e')$  for some  $e' \in E(T)$ . Moreover,  $g$  is isotopic to a homeomorphism which preserves  $\cup_{e \in E(T)} S(e)$  by an isotopy preserving  $F(T, w; \rho)$ .

Proof. The first assertion follows from Theorem 2.4 and the fact stated in the above. The second assertion can be proved by applying the argument in this section and Section 4 to the family  $\{S(e)\}_{e \in E(T)}$  of 4-Murasugi spheres.

**8. Proof of Theorems 2.6 and 2.7**

The arguments in this section are based on Corollary 7.3 and the following fact.

**Lemma 8.1.** *Let  $(T, w)$  be a finite weighted plane tree, and suppose that the weight  $w$  is special. Let  $\rho_+$  and  $\rho_-$  be the alternating orientations for  $T$ . Then the pair of the Seifert surfaces  $F(T, w; \rho_+)$  and  $F(T, w; \rho_-)$  is “characteristic”; that is, for any isomorphism  $g$  between two very special arborescent links  $L(T, w)$  and  $L(T', w')$ ,  $g(F(T, w; \rho_\varepsilon))$  ( $\varepsilon = +, -$ ) is equivalent to  $F(T', w'; \rho'_+)$  or  $F(T', w'; \rho'_-)$ , where  $\rho'_+$  and  $\rho'_-$  are the alternating orientations for  $T'$ .*

Proof. By Proposition 5.3, the number of the vertices in the complex  $MS(L(T, w))$  which are adjacent to a vertex  $[F(T, w; \rho)]$  is equal to the number of the vertices of  $T$  which are positive or negative with respect to  $\rho$ . The maximum of these numbers when  $\rho$  runs over  $\mathcal{O}(T)$  is equal to  $|V(T)|$ , and it is attained by the alternating orientations. Thus we obtain the desired result by Theorem 2.3.

Recall that  $B^3(e, v)$ , where  $v \in V(T)$  and  $e \in E(v, T)$ , denotes the 3-ball in  $S^3$  bounded by  $S(e)$  whose interior is disjoint from  $A(v)$ . Let  $P^3(v) = cl(S^3 - \cup_{e \in E(v, T)} B^3(e, v))$ . Then  $A(v)$  is a properly embedded surface in  $P^3(v)$ . For each  $e \in E(T)$ , put  $l(e) = S(e) \cap (A(v_1) \cup A(v_2))$ , where  $v_1$  and  $v_2$  are the end-points of  $e$ . Then  $l(e)$  is a circle in  $S(e)$  which divides  $S(e)$  into two plumbing patches for the minimal genus Seifert surfaces for  $L(T, w)$  (see Figure 8.1 (a)).

Proof of Theorem 2.6. Suppose there is an isomorphism  $g$  between the semi-oriented links  $(S^3, L(T, w))$  and  $(S^3, L(T', w'))$ . By the above lemma, we may suppose  $g(F(T, w; \rho_+)) = F(T', w'; \rho'_\varepsilon)$  ( $\varepsilon = +$  or  $-$ ). By Corollary 7.3, we may further suppose  $g(\cup_{e \in E(T)} S(e)) = \cup_{e' \in E(T')} S(e')$ . Thus we obtain an isomorphism  $g_*$  between the abstract graphs  $T$  and  $T'$  such



that  $g(P^3(v), A(v)) = (P^3(g_*(v)), A(g_*(v)))$  and  $g(S(e)) = S(g_*(e))$  ( $v \in V(T)$ ,  $e \in E(T)$ ). Since  $g(l(e)) = l(g_*(e))$  for any  $e \in E(T)$ , we see that, for each  $v \in V(T)$ ,  $g$  induces a homeomorphism  $g_v$  from  $(S^3, F(v))$  to  $(S^3, F(g_*(v)))$  such that  $g_v(D(e, v)) = D(g_*(e), g_*(v))$  for any  $e \in E(v, T)$ . Thus we see  $w'(g_*(v)) = w(v)$  or  $-w(v)$  according to whether  $g$  preserves the orientation of  $S^3$  or not. Define  $\varepsilon_c(v)$  [resp.  $\varepsilon_n(v)$ ] so that  $g_v$  sends the core orientation  $c_v$  [resp. the normal orientation  $n_v$ ] of  $F(v)$  to  $\varepsilon_c(v)c_{g_*(v)}$  [resp.  $\varepsilon_n(v)n_{g_*(v)}$ ]. Then the map  $g_*|_{E(v, T)}: E(v, T) \rightarrow E(g_*(v), T')$  preserves or reverses the cyclic order according as  $\varepsilon_c(v) = +1$  or  $-1$ . On the other hand, by considering the orientations of the Seifert surfaces, we see that the product  $\varepsilon_c(v)\varepsilon_n(v)$  does not depend on  $v$ . If  $\varepsilon_c(v)\varepsilon_n(v) = +1$ , then  $g_*$  preserves the cyclic order at every vertex or reverses the cyclic order at every vertex. If  $\varepsilon_c(v)\varepsilon_n(v) = -1$ , then  $g_*$  reverses the cyclic order at one vertex, and at each vertex at even distance from it, and  $g_*$  preserves the cyclic order at the remaining vertices. Hence  $g_*$  determines an isogeny between  $(T, w)$  and  $(T', w')$ . Conversely, by the above argument, we see any isogeny between  $(T, w)$  and  $(T', w')$  induces an isomorphism between  $L(T, w)$  and  $L(T', w')$ . This completes the proof of Theorem 2.6.

To prove Theorem 2.7, we need the following proposition:

**Proposition 8.2.** *Let  $L$  be a non-fibred, unsplittable, semi-oriented link in  $S^3$  and  $F$  an incompressible Seifert surface for  $L$ . Let  $g$  be a self-homeomorphism of  $(S^3, L)$  which preserves  $F$ . Suppose  $g$  is pairwise isotopic to the identity. Then there is a pairwise isotopy from  $g$  to the identity which preserves  $F$ .*

Proof. This proposition is analogous to [2, Proposition 6.19], and can be proved by applying the argument of [28, Section 7] to the restriction of  $g$  to  $E(L)$  and a hierarchy for  $E(L)$  starting from the surface  $F \subset (E(L))$ .

The first step of our proof of Theorem 2.7 is the following lemma.

**Lemma 8.3.** *For a very special arborescent link  $L(T, w)$ , there is a well defined epimorphism  $\gamma: \text{Sym}_s(S^3, L(T, w)) \rightarrow \text{Sym}(T, w)$ . By restriction, it gives an epimorphism  $\gamma^+: \text{Sym}_s^+(S^3, L(T, w)) \rightarrow \text{Sym}^+(T, w)$ .*

Proof. Let  $g$  be a self-isomorphism of the semi-oriented link  $L(T, w)$ . Then as in the proof of Theorem 2.6, we may assume  $g(F(T, w; \rho_+)) = F(T, w; \rho_\varepsilon)$  ( $\varepsilon = +$  or  $-$ ),  $g(\cup_{e \in E(T)} S(e)) = \cup_{e \in E(T)} S(e)$ , and  $g$  induces a self-isogeny  $g_*$  of  $(T, w)$ . We would like to define  $\gamma$  by  $\gamma(g) = g_*$ . To show that this is well-defined, we show that  $g_* = 1$  if  $g$  is

pairwise isotopic to the identity. Suppose  $g$  is pairwise isotopic to the identity. Then, by Proposition 8.2, there is a pairwise isotopy from  $g$  to the identity which preserves  $F(T, w; \rho_+)$ , since  $L(T, w)$  is not fibred. Thus  $g$  preserves each  $S(e)$  ( $e \in E(T)$ ) by Theorem 2.4. So we have  $g_* = 1$ , and hence the homomorphism  $\gamma$  is well-defined. By the proof of Theorem 2.6, we see that  $\gamma$  is surjective.

The next step for the proof of Theorem 2.7 is the determination of  $\text{Ker}(\gamma)$ . For each  $v \in V(T)$ , let  $\zeta_v$  be the involution of the pair  $(P^3(v), A(v))$  as illustrated in Figure 8.1 (a). In case  $|E(v, T)| \leq 2$ , let  $\eta_v$  be the involution of  $(P^3(v), A(v))$  as illustrated in Figure 8.1 (b). Note that  $\zeta_v$  and  $\eta_v$  generates a  $\mathbf{Z}_2 \oplus \mathbf{Z}_2$ -action on  $(P^3(v), A(v))$ . Let  $G(v)$  be the group of transformations of  $(P^3(v), A(v))$  generated by  $\{\zeta_v, \eta_v\}$  or by  $\{\zeta_v\}$  according to whether  $|E(v, T)| \leq 2$  or not. Then  $G(v)$  preserves each  $l(e)$  ( $e \in E(v, T)$ ).

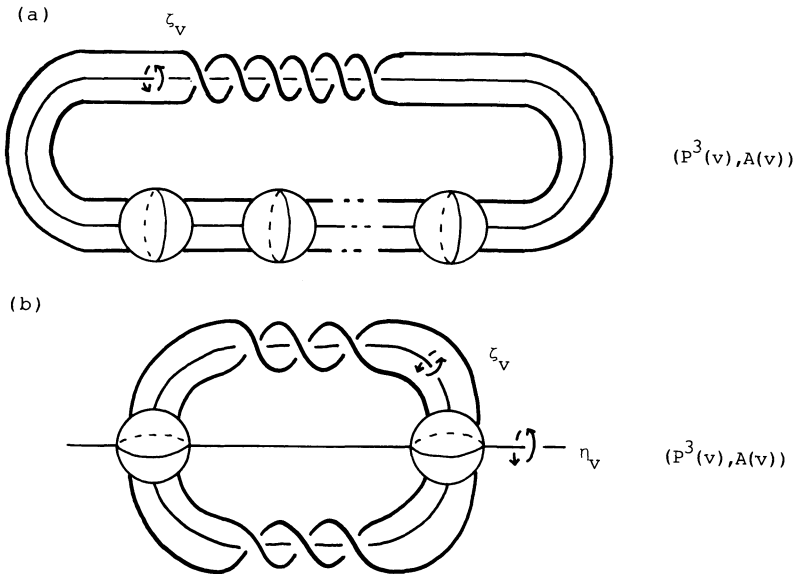

Figure 8.1

**Lemma 8.4.** *Let  $g$  be a self-homeomorphism of  $(P^3(v), A(v))$  which preserves each  $l(e)$  ( $e \in E(v, T)$ ). Then  $g$  is pairwise isotopic to an element of  $G(v)$ . Further, if the restriction of  $g$  to  $\partial P^3(v)$  is equal to the restriction of an element, say  $\zeta$ , of  $G(v)$ , then  $g$  is pairwise isotopic to  $\zeta$  by a pairwise isotopy which is constant on  $\partial P^3(v)$ .*

Proof. Using the assumption for  $g$  and the fact that each component of  $A(v)$  is a disk (or an annulus when  $k=0$ ), we can see that there is an element  $\xi$  of  $G(v)$  such that the restrictions of  $g$  to  $A(v)$  and  $S(e)$  ( $e \in E(v, T)$ ) are isotopic to those of  $\xi$ . Thus, by using the fact that  $cl(P^3(v) - N(\partial P^3(v) \cup A(v); P^3(v)))$  is a solid torus, we can see that  $g$  is pairwise isotopic to  $\xi$ . If  $g|_{S(e)} = \xi|_{S(e)}$ , then the isotopy can be made constant on  $S(e)$ .

Let  $e$  be an edge of  $T$ , and let  $v_1$  and  $v_2$  be the end-points of  $e$ , and suppose the valency of  $v_1$  is 1 or 2. Then we may suppose  $\eta_{v_1}|_{S(e)} = \zeta_{v_2}|_{S(e)}$ . Using this fact, we can define the group  $\Gamma(T)$  of self-isomorphisms of  $L(T, w)$  as follows:

Case 1.  $|T|$  is an interval or a point, that is, the valency of any vertex of  $T$  is equal to 1 or 2: Fix a vertex  $v_0$ , and let  $\zeta$  [resp.  $\eta$ ] be the self-isomorphism of  $L(T, w)$  whose restriction to  $P(v)$  is equal to  $\zeta_v$  [resp.  $\eta_v$ ] or  $\eta_v$  [resp.  $\zeta_v$ ] according as  $v$  is at even distance or odd distance from  $v_0$ . Then  $\zeta$  and  $\eta$  are commutative involutions and they generate a  $\mathbf{Z}_2 \oplus \mathbf{Z}_2$ -action on  $(S^3, L(T, w))$ . We define  $\Gamma(T)$  to be this group.

Case 2.  $|T|$  is neither an interval nor a point, and there is a vertex  $v_0$  of  $T$ , such that any vertex at an odd distance from  $v_0$  has valency 1 or 2: Then let  $\zeta$  be the self-homeomorphism of  $L(T, w)$  defined as in the above. Then  $\zeta$  is an involution, and we define  $\Gamma(T)$  to be the group generated by  $\zeta$ .

Case 3. Otherwise: Then  $\Gamma(T) = 1$ .

By using Lemma 8.4 and the fact that any element in  $Ker(\gamma)$  is represented by a self-isomorphism  $g$  of  $(S^3, L(T, w))$  preserving each  $S(e)$  ( $e \in E(T)$ ) and each  $A(v)$  ( $v \in V(T)$ ), we can see that there is an epimorphism from  $\Gamma(T)$  to  $Ker(\gamma)$ . Further, since each element of  $\Gamma(T)$  preserves the orientation of  $S^3$ , we see  $Ker(\gamma^+) = Ker(\gamma)$ .

To see that  $\Gamma(T)$  injects to  $Ker(\gamma)$ , note that each of  $\zeta$  and  $\eta$ , if it is defined, maps  $F(T, w; \rho_+)$  to  $F(T, w; \rho_-)$ . Since these two Seifert surfaces are not equivalent by Theorem 2.3,  $\zeta$  and  $\eta$  represent nontrivial elements in  $Ker(\gamma)$ . This shows the injectivity in Case 2. To show the injectivity in Case 1, we have only to show that the composite map  $\zeta\eta$  is not pairwise isotopic to the identity. Suppose it is pairwise isotopic to the identity. Then, by Proposition 8.2, there is a pairwise isotopy from  $\zeta\eta$  to the identity which preserves  $F(T, w; \rho_+)$ . This contradicts the fact that  $\zeta\eta$  acts on the nontrivial free abelian group  $H_1(S^3 - F(T, w; \rho); \mathbf{Z})$  as the multiplication by  $-1$ . This completes the proof of Theorem 2.7.

## ACKNOWLEDGEMENT

Part of this work was done while I was visiting at Toronto University and Ruhr University. I should like to express my sincere gratitude to Prof. K. Murasugi and Prof. H. Zieschang for their kind hospitality and encouragement. I should also like to thank Professors F. Bonahon and L. Siebenmann for giving me a chance to read [2], which deeply inspired me, and Professors O. Kakimizu, T. Kobayashi, M. Saito, and S. Yamada for valuable conversations.

## References

- 
- [1] M. Boileau and B. Zimmermann: *Symmetries of nonelliptic Montesinos links*, Math. Ann. **277** (1987), 563–584.
  - [2] F. Bonahon and L. Siebenmann: *Geometric splittings of links, and Conway's algebraic knots*, preprint.
  - [3] S. Eilenberg and N. Steenrod: "Foundations of algebraic topology," Princeton Univ. Press, 1952.
  - [4] D.B.A. Epstein: *Curves on 2-manifolds and isotopies*, Acta Math. **115** (1966), 83–107.
  - [5] D. Gabai: *The Murasugi sum is a natural geometric operation*, Contemporary Math. A.M.S. **20** (1983), 131–143.
  - [6] D. Gabai: *The Murasugi sum is a natural geometric operation II*, Contemporary Math. A.M.S. **44** (1985), 93–100.
  - [7] D. Gabai: *Foliations and genera of links*, Topology **23** (1984), 381–394.
  - [8] D. Gabai: *Detecting fibred links*, Comment. Math. Helv. **61** (1986), 519–555.
  - [9] D. Gabai: *Genera of arborescent links*, Mem. A.M.S. **339** (1986).
  - [10] H. Goba: *Heegaard splitting for sutured manifolds and Murasugi sum*, Osaka J. Math. **29** (1992), 21–40.
  - [11] Y. Hashizume: *On the uniqueness of the decomposition of a link*, Osaka Math. J. **10** (1958), 283–300.
  - [12] A. Hatcher and W. Thurston: *Incompressible surfaces in 2-bridge knot complements*, Inv. Math. **79** (1985), 225–246.
  - [13] O. Kakimizu: Talk at the meeting "Knot theory and related topics" held in Osaka, 1989.
  - [14] O. Kakimizu: *Finding disjoint incompressible spanning surfaces for a link*, Hiroshima Math. J. **22** (1992), 225–236.
  - [15] O. Kakimizu: *Classification of the incompressible spanning surfaces for prime knots of  $\leq 10$  crossings*, preprint.
  - [16] T. Kobayashi: *Uniqueness of minimal genus Seifert surfaces for links*, Topology and its Appl. **33** (1989), 265–279.
  - [17] T. Kobayashi: *Minimal genus Seifert surfaces for unknotting number 1 knots*, Kobe J. Math. **6** (1989), 53–62.
  - [18] F. Laudenbach: *Topologie de la dimension trois homotopie et isotopie*, Asterisque **12** (1974).
  - [19] K. Murasugi: *On a certain subgroup of the group of an alternating link*, Amer. J. Math. **85** (1963), 544–550.

- [20] K. Murasugi: *Invariants of graphs and their applications to knot theory*, Algebraic Topology, Poznań 1989, Lect. Notes in Math. **1474**, Springer-Verlag, 1991, 83–97.
- [21] M. Sakuma: *Periods of composite links*, Math. Sem. Notes, Kobe Univ. **9** (1981), 445–452.
- [22] M. Sakuma: *Uniqueness of symmetries of knots*, Math. Z. **192** (1986), 225–242.
- [23] M. Sakuma: *The geometries of spherical Montesions links*, Kobe J. Math. **7** (1990), 167–190.
- [24] M. Scharlemann and A. Thompson: *Finding disjoint Seifert surfaces*, Bull. London Math. Soc. **20** (1988), 61–64.
- [25] M. Scharlemann and A. Thompson: *Link genus and the Conway moves*, Comment. Math. Helv. **64** (1989), 527–535.
- [26] H. Schubert: *Die eindeutige Zerlegbarkeit eines Knoten im Primknoten*, Sitzungsber. Akad. Wiss. Heiderberg, math-nat. **3** (1949), 57–104.
- [27] H. Schubert: *Knoten mit zwei Brücken*, Math. Z. **65** (1956), 1334–170.
- [28] F. Waldhausen: *On irreducible 3-manifolds which are sufficiently large*, Ann. of Math. **87** (1968), 56–88.

Department of Mathematics,  
Faculty of Science,  
Osaka University,  
Toyanaka, Osaka, 560  
Japan  
sakuma@math.wani.osaka-u.ac.jp

