

Parrondo's Paradox

G. P. Harmer and D. Abbott

Abstract. We introduce Parrondo's paradox that involves games of chance. We consider two fair gambling games, A and B, both of which can be made to have a losing expectation by changing a biasing parameter ε . When the two games are played in any alternating order, a winning expectation is produced, even though A and B are now losing games when played individually. This strikingly counter-intuitive result is a consequence of discrete-time Markov chains and we develop a heuristic explanation of the phenomenon in terms of a Brownian ratchet model. As well as having possible applications in electronic signal processing, we suggest important applications in a wide range of physical processes, biological models, genetic models and sociological models. Its impact on stock market models is also an interesting open question.

Key words and phrases: Gambling paradox, Brownian ratchet, noise.

1. INTRODUCTION

The study of probability dates back to the seventeenth century. It arises from games of chance, originating from the ancient game of throwing bones—the forerunners of dice. Strongly associated with probability is gambling; from dice to actuarial tables and risk-benefit analysis, gambling has always been at the forefront of expanding probability theory (Shlesinger, 1996). This dates back to correspondence between Pascal and Fermat in 1654 when a problem was posed to Pascal by a French gambler. “Games of chance” can be considered a process that consists of random events or random variables. The erratic Brownian motion of dust particles or pollen grains in a liquid, due to collisions with the liquid molecules, is the classic example (Hughes, 1995). The motion of each grain is sufficiently erratic that it can be considered to be random, the simplest model being that of a random walk.

Random motion or “noise” in physical systems is usually considered to be a deleterious effect. However, the rapidly growing fields of stochastic resonance (Berdichevsky and Gitterman, 1998; Gammaitoni, Hänggi, Jung and Marchesoni, 1998) and Brownian ratchets (Bier, 1997a) have brought the

increasing realization that random motion can play a constructive role.

The apparent paradox that two losing games A and B can produce a winning expectation, when played in an alternating sequence, was devised by Parrondo as a pedagogical illustration of the Brownian ratchet (Parrondo, 1997). However, as Parrondo's games are remarkable and may have important applications in areas such as electronics, biology and economics, they require analysis in their own right.

In this paper, we first introduce the concept of the Brownian ratchet and then illustrate Parrondo's games. Graphical simulations of the outcomes of Parrondo's games are then explained in terms of the Brownian ratchet model.

1.1 Brownian Ratchets

A ratchet and pawl device, shown in Figure 1, was introduced in the last century as a proposed perpetual motion machine: the aim was to try and harness the thermal Brownian fluctuations of gas molecules, by a process of rectification. The device is considered to be of molecular scale and works in the following manner. Let the temperature of the thermal bath in the boxes be equal so $T_1 = T_2 = T$. Hence, the energy, which is directly related to the temperature of the thermal baths, is also equal in each bath. Due to the bombardments of gas molecules on the vane, it oscillates and jiggles. Since the wheel at the other end of the axle only turns one way, motion in one direction will cause the axle to turn while motion in the other direction will not. Thus the wheel will turn slowly and may

G. P. Harmer and D. Abbott are with the Centre for Biomedical Engineering (CBME), Department of Electrical and Electronic Engineering, University of Adelaide, SA 5005, Australia (e-mail: gpharmer@eleceng.adelaide.edu.au and dabbott@eleceng.adelaide.edu.au).

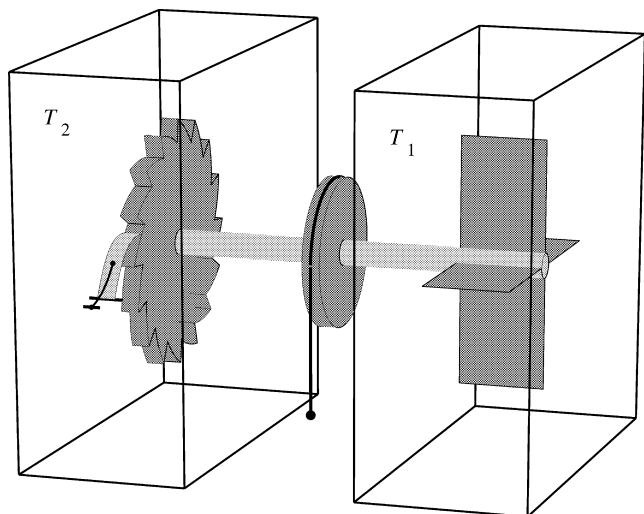

FIG. 1. The ratchet and pawl machine. There are two boxes with a vane in one and a wheel that can only turn one way, a ratchet and pawl, in the other. Each box is in a thermal bath of gas molecules at equilibrium. The two boxes are connected mechanically by a thermally insulated axle. The whole device is considered to be reduced to microscopic size so gas molecules can randomly bombard the vane to produce motion.

even be able to lift some weight. This is a violation of the Second Law of Thermodynamics. This creates a paradox; the ratchet and pawl will apparently work in perpetual motion when $T_1 = T_2$. However, at equilibrium the effect of thermal noise is symmetric, even in an anisotropic medium. The Second Law implies that structural forces alone cannot bias Brownian motion as has been suggested with the ratchet and pawl device.

The short answer to the paradox is that at equilibrium when $T_1 = T_2$, there is no net motion of the wheel because the spring loaded pawl must also fluctuate with Brownian motion. This releases the ratchet wheel to rotate in either direction. These fluctuations and the bombardments of gas molecules on the vane are dependent on the energy of the thermal bath. These fluctuations are not defects in the ratchet; the whole device can be constructed of perfectly, ideal elastic parts. A longer answer to the paradox can be found in *The Feynman Lectures on Physics* (Feynman, Leighton and Sands, 1963), which gives a more complete explanation of the workings of the ratchet and pawl machine. Since there is no net movement at equilibrium, weight can only be lifted when energy is put into the system by maintaining $T_1 > T_2$.

In 1912, Smoluchowski (Smoluchowski, 1912) was the first to find this correct explanation for the ratchet and pawl device, which he called *Zahnrad mit einer Sperrklinke* in German. This device was later revisited by Feynman (Feynman, Leighton and Sands, 1963). Even though, to this day, no one

has been able to successfully derive the equations of detailed balance (Abbott, Davis and Parrondo, 1999) for this system and Feynman's work has been disputed (Parrondo and Español disagree with the efficiency of the ratchet and pawl engine calculated by Feynman; Parrondo and Español, 1996), it has been the source of inspiration for the "Brownian ratchet" concept.

The seminal paper for the Brownian ratchet was in 1993 by Magnasco (1993), where it was shown that Brownian particles could have directed motion in certain spatially asymmetric periodic energy potential profiles.

The focus of recent research is to harness Brownian motion and convert it to directed motion, or more generally, a Brownian motor, without the use of macroscopic forces or gradients. This research was inspired by considering molecules in chemical reactions, termed "molecular motors" (Astumian and Bier, 1994). The roots of these Brownian devices trace back to Feynman's exposition of the ratchet and pawl system. By supplying energy from external fluctuations or nonequilibrium chemical reactions in the form of thermal or chemical gradients, directed motion is possible even in an isothermal system (Astumian, 1997; Bier, 1997b). These types of devices have been shown to work theoretically (Astumian and Bier, 1994; Magnasco, 1993), even against a small macroscopic gradient (Hänggi and Bartussek, 1996). Recently, with the technology available to build micrometer scale structures, many manmade Brownian ratchet devices have been constructed and actually work (Astumian, 1997; Bier, 1997a).

A striking example is when a tilted periodic potential is toggled "on" and "off"; by solving the Fokker-Planck equation for this so-called "flashing ratchet," Brownian particles are shown to move "uphill" (Doering, 1995). If the potential is held in either the "on" state or the "off" state, the particles move "downhill." This is the inspiration for Parrondo's paradox: the individual states are said to be like "losing" games and when they are alternated we get uphill motion or a "winning" expectation.

1.2 Parrondo's Games

Game A, which is described by (1), is straightforward and can be thought of as tossing a weighted coin or going on a biased random walk:

$$(1) \quad \begin{aligned} \text{Game A: } \mathbf{P}[\text{winning}] &= \frac{1}{2} - \varepsilon \\ \mathbf{P}[\text{losing}] &= \frac{1}{2} + \varepsilon. \end{aligned}$$

Since game A is well known, a solution can be derived from the transition probabilities of winning and losing by considering it as a one-dimensional

random walk (Grimmett and Stirzaker, 1982; Hughes, 1995). The states $S = \{0, \pm 1, \pm 2, \dots\}$, which usually represent the displacement of the walk, are defined as being the capital, negative states indicating a loss. The transition probabilities for game A are

$$(2) \quad p_{ij} = \begin{cases} p, & \text{if } j = i + 1, \\ q = 1 - p, & \text{if } j = i - 1, \\ 0, & \text{otherwise,} \end{cases}$$

where $p = 1/2 - \varepsilon$ is the probability of winning and accordingly $q = 1/2 + \varepsilon$ is the probability of losing. The transition probability defined as $p_{ij} = P(X_{n+1} = j | X_n = i)$ is the probability of going from state i to state j in one game and X_n is the random variable that represents the amount of capital at game n . The solution is

$$(3) \quad p_{ij}(n) = \begin{cases} \binom{n}{\frac{1}{2}(n+j-i)} p^{(n+j-i)/2} q^{(n-j+i)/2}, & \text{if } n+j-i \text{ is even,} \\ 0, & \text{otherwise,} \end{cases}$$

where $p_{ij}(n)$ is the probability of ending at state j after n games, given that we started at state i at $n = 0$. The probability distribution from a fixed starting position for a given number of games is a binomial distribution; see the thick line curves in Figure 2.

The random variable Y , which counts the number of success on n trials has a binomial distribution $B(n, p)$. This is approximately $N(np, npq)$ in the continuous limit. Considering the losses as well, the change in capital is $Y - (n - Y) = 2Y - n$, which is approximately

$$(4) \quad N(n(p - q), 4npq).$$

Game B is a little more complex and can be generally described by the following statement. If the present capital is a multiple of M , then the chance of winning is p_1 , if not, then the chance of winning is p_2 . Substituting Parrondo's original numbers for these variables, $M = 3$, $p_1 = 1/10 - \varepsilon$ and $p_2 = 3/4 - \varepsilon$, gives game B as

$$(5) \quad \begin{aligned} \text{Game B: } \mathbf{P}[\text{winning} | \text{capital mod } 3 = 0] &= \frac{1}{10} - \varepsilon \\ \mathbf{P}[\text{losing} | \text{capital mod } 3 = 0] &= \frac{9}{10} + \varepsilon \\ \mathbf{P}[\text{winning} | \text{capital mod } 3 \neq 0] &= \frac{3}{4} - \varepsilon \\ \mathbf{P}[\text{losing} | \text{capital mod } 3 \neq 0] &= \frac{1}{4} + \varepsilon. \end{aligned}$$

Using the derivation for game A in (3) and computer simulations for both the games as described in (1) and (5), the probability distributions of the

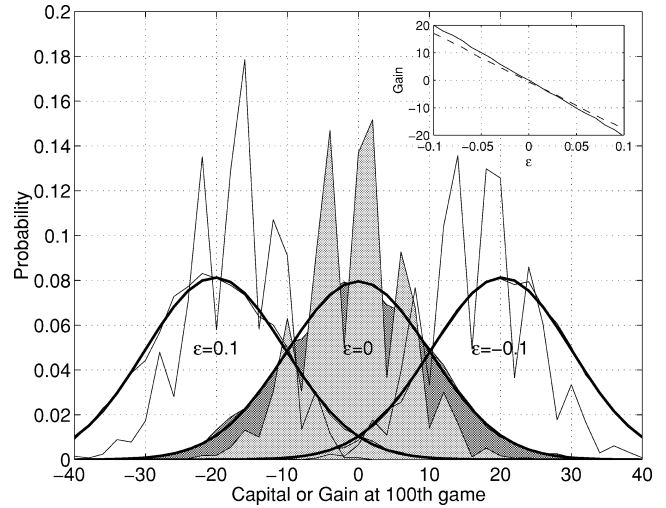

FIG. 2. Three probability distribution functions of both games from simulations [game A from (1), dark shading, and game B from (5), light shading] with values for ε of $-0.1, 0$ and 0.1 . The simulations played each game 100 times and averaged over 10,000 runs. The thick line shows the theoretical results for game A given by (3). The inset shows gain versus ε after playing 100 games, the solid line for game A and dashed line for game B. All curves are normalized to have unity area. The distributions with value zero have been omitted.

two games are shown in Figure 2. We refer to *capital* and *gain* as if anyone playing these games is against a common opponent, the bank, for example. The gain is based upon a one-unit capital where negative gains indicate a loss; thus a gain of five is equivalent to five units of capital. It is seen here that the two games are fair and that they start losing for $\varepsilon > 0$.

We will digress for a moment to discuss what constitutes a fair game. The reason is that the behavior of game B differs from game A as we are likely to win or lose a small amount depending on the starting capital. If the starting capital is a multiple of 3, then we will lose a little and vice versa. The deviations from different starting capitals after 100 games are shown in Figure 7b. The concept of what it means for a game to be winning, losing or fair can be defined precisely in terms of hitting probabilities and expected hitting times of discrete-time Markov chains. In this paper we shall be a little looser with this terminology. We shall consider a game to be winning, losing or fair according to whether the probability of moving up n states is greater than, less than, or equal to the probability of moving down n states as n becomes large.

Using the above criterion, both game A and game B are fair when ε is set to zero. This is true of game A because the probabilities of moving up and down n states are equal for all n . It is also true of

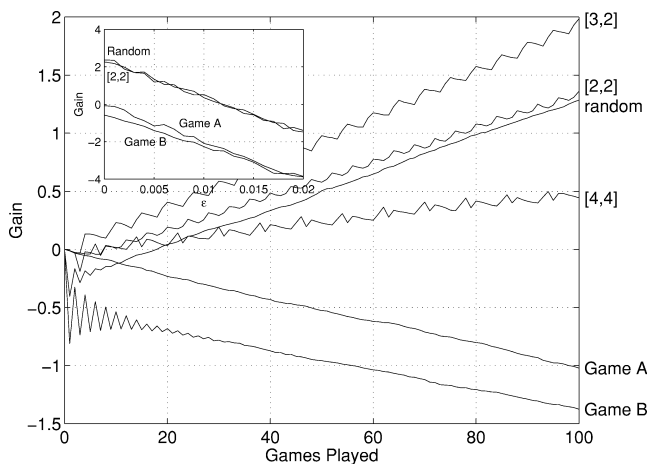

FIG. 3. The main plot shows the effect of playing A and B individually and the effect of switching between games A and B. The simulation was performed by playing $(A_{0.005}^a B_{0.005}^b)^{100/a+b}(0)$ and averaged over 50,000 trials. The values of a and b are shown by the vectors $[a, b]$. The inset shows the effect of the games' performance when varying ε by playing the games individually and alternately. That is, the inset shows the outcome after the 100th game is played.

game B even though the value of the starting capital influences the probability of going up and down n states for small values of n . Although there is some concern over whether game B is technically fair, it is not important here, since when $\varepsilon > 0$ it definitely loses. This is satisfactory since the only prerequisite we have on games A and B is that they lose when $\varepsilon > 0$.

2. RESULTS

It is clear now that both game A and game B lose when $\varepsilon > 0$. Consider the scenario if we start switching between the two losing games, play two games of A, two games of B, two of A, and so on. (The act of playing a game can not be broken up; that is, a game is either played in its entirety or not played at all.) The result, which is quite counter intuitive, is that we start winning. That is, we can play the two losing games A and B in such a way as to produce a winning expectation. Furthermore, deciding which game to play by tossing a fair coin also yields a winning expectation. Figure 3 shows the progress when playing games A and B, as well is the effect of switching periodically and randomly between the games. The effect of varying the parameter ε on the final capital is shown in the inset of Figure 3. The amount that games A and B lose by, when played individually, continues to increase as ε is increased. This also occurs with the alternating games until a point is reached where they no longer win.

When we consider the ratchet and pawl machine, we can only get directed motion of the weight when energy is added to the system. Similarly for a flashing Brownian ratchet, energy is taken up by switching between two states to produce “uphill” motion of Brownian particles. In the simulations of Parrondo's games, from two losing games we can yield a winning expectation. This creates a paradox, “money for free.” Where is the “energy” coming from in Parrondo's games? This is an unsolved problem and remains an open question. Perhaps the answer lies in the context in which Parrondo's games are applied. For instance, assuming they can be applied to stock market models, the “switching energy” can be thought of as the buying and selling transaction cost. However, in the case of two individuals gaming, the interpretation of switching energy becomes problematic; this appears truly paradoxical.

At this point we introduce new notation to describe how the games are played. If the games A and B are played with the bias parameter ε , they can be called A_ε and B_ε , respectively. Playing game A n times is denoted by A_ε^n . Alternating between games, playing game A a times, then game B b times and so on, for example, is represented by $(A_\varepsilon^a B_\varepsilon^b)^n$. The starting capital can be shown in parentheses as $A_\varepsilon(0)$ or $(A_\varepsilon^a B_\varepsilon^b)^n(x)$. By omitting the starting capital, we can assume the games start with zero capital.

Now it has been shown that a winning expectation can be produced by switching between games A and B, the question is, *does the sequence of this switching influence the gain?* A simulation that varied the sequence at which the games were switched was carried out. Figure 4 shows the variation of gain when changing the switching sequence; each point corresponds to playing a total of 500 games of either A or B.

Changing the values of the parameters M , p_1 and p_2 for game B varies the performance of the switched games vastly. The variables were changed by trial and error so that when $\varepsilon = 0$, game B was still fair. The first comparison was executed by keeping $M = 3$ and changing p_1 and p_2 . The result is shown in Figure 5a. We note that as p_1 approaches $1/2$ the gain approaches zero, since when $p_1 = 1/2$, game B is essentially the same as game A. The second comparison, shown in Figure 5b, was carried out with $p_1 = 0.1$ and varying M and p_2 . As M is likely to affect the periodicity of game B, several switching sequences were compared.

3. DISCUSSION

There are several mechanisms by which directed Brownian motion can be achieved (Fauchaux, Bour-

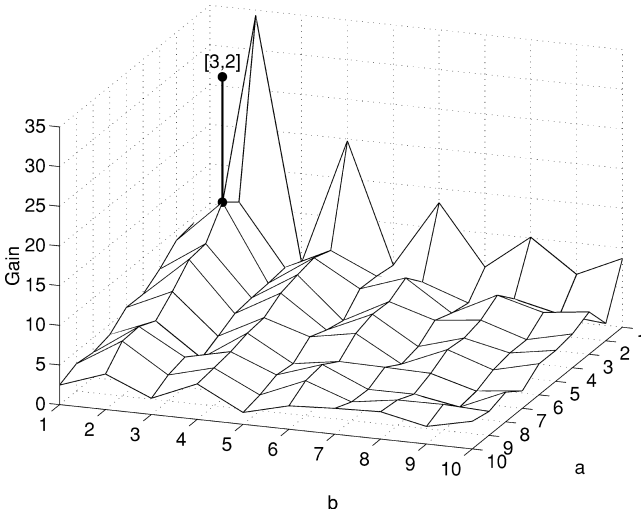

FIG. 4. The effect of varying the sequence of switching between games. The simulations were performed playing 500 games according to $(A_0^a B_0^b)^{500/a+b}(0)$ and averaged over 1000 trials. The example point $(A_0^3 B_0^2)^{100}(0)$ indicates that game A was played three times, then game B two times, which was repeated 100 times to give the total number 500 of games played.

dieu, Kaplan and Libchaber, 1995; Rousselet, 1994). We will now deal with a mechanism that may give some insight into what is happening between our two games. Consider a system where there exists two one-dimensional potentials, U_{on} and U_{off} , as shown in Figure 6. The asymmetry of the potential U_{on} is determined by α , where $0 \leq \alpha \leq 1$. Having $\alpha = 1/2$ creates a triangular symmetric potential; otherwise the potential is asymmetrical like U_{on} in Figure 6 where $\alpha < 1/2$. Let there be Brownian particles existing in the potential diffusing to a position of least energy. In equilibrium, if the potential height is larger than the thermal noise, the

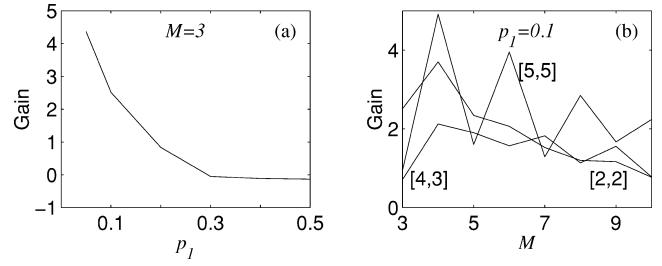

FIG. 5. The effect of gain when the parameters of game B are varied. Simulations were performed with $\epsilon = 0$. (a) Keeping M constant. (b) Keeping p_1 constant. Each value of p_2 for each M (or p_1) was set to satisfy detailed balance ($\epsilon = 0$).

particles are localized in a potential minima. However, time modulating the potential U_{on} for time τ_{on} and U_{off} for time τ_{off} can induce motion. When the U_{on} is applied, the particles are trapped in the minima of the potential so the concentration of the particles is peaked. Switching the potential off allows the particles to diffuse freely, so the concentration at the end of time off τ_{off} is a set of Gaussian curves centered around the minima. When U_{on} is switched on again, there is a probability P_{fwd} that is proportional to the darker shaded area of the curve that some particles are to the right of αL . These particles move forward to the minima located at L . Similarly, there is a probability P_{bck} (lightly shaded) that some particles are to the left of $-(1 - \alpha)L$ and move to the left minima located at $-L$. Since the potential is asymmetrical, as shown in Figure 6 with $\alpha < 1/2$, then $P_{fwd} > P_{bck}$ and the net motion of the particles is to the right. We can define the probability current as $J = P_{fwd} - P_{bck}$ for a particle diffusing forward one step in the potential.

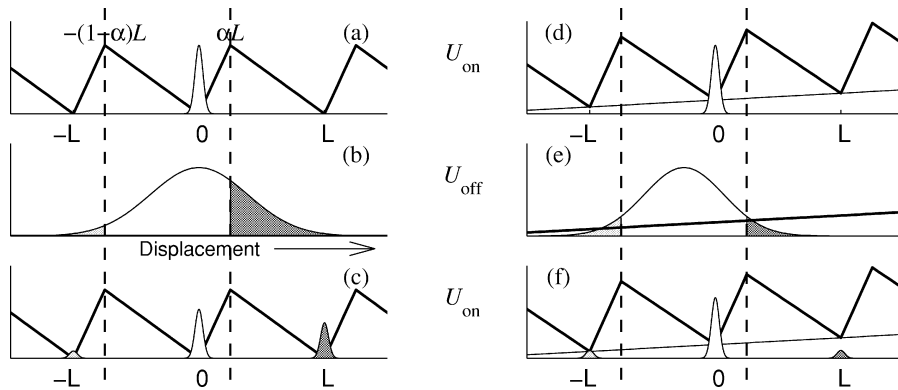

FIG. 6. The mechanism of the ratchet potential. The diagrams on the left, (a)–(c), show when there is no macroscopic gradient present and the net movement of particles is in the forward direction (defined by arrow). The diagrams on the right, (d)–(f), have a slight gradient present; this causes the particles to drift backwards while U_{off} is acting. Hence the net flow of particles in the forward direction is reduced.

If we consider the ratchet potentials in Figure 6, and the outcomes of the games in Figure 3, they can be related. With $\varepsilon = 0$ the games are fair, but there is a maximum gain when the games are alternated; similarly, when there is no macroscopic gradient, there is a maximum movement of particles in the Brownian ratchet. As ε is increased, the gain falls until a critical value of ε is reached. This is about 0.012 (see the inset of Figure 3) when alternating the games no longer produces a winning expectation. Similarly, the gradient can be increased (see Figure 6) until a value is reached where there is no net movement of particles. There is some similarity in the way that the two systems behave as the parameter ε is analogous to the macroscopic gradient.

Observing that the two systems behave similarly, an appropriate assumption would be that game B has a potential associated with it, like that of the ratchet. The problem is determining this potential, if it exists. In the case of a real physical system, one method of determination would be to uniformly place particles on the potential, recording their starting position, then leaving them until they reached equilibrium and finding out where they settled. For example, if there was an unknown potential like the one shown in Figure 6(a), then the result would look like Figure 7a. The trajectory patterns of the particles are directly related to the shape of the potential. For game B we can treat the capital like the particles in the Brownian ratchet. Thus, to find the potential of game B, we start with different amounts of capital, play a number of games until steady state is reached and record the final capital. All the results are shown in Figure 7. The movement of capital for game B is shown in (b), which has a pattern that repeats itself when the capital is a multiple of three. This is to be expected from the rules given in (5). The derived potential is shown as the solid line in (c). Where different values of starting capital converge together (e.g., a capital of 2.3 and 2.5), narrow spikes are formed in the resulting potential. By approximating the distributions on either side of the spikes as a single distribution, the spikes can be removed to give a clearer picture of the potential. The resulting potential is shown as the dashed line in Figure 7c. This consists of a symmetric and an asymmetric potential, thus could be considered asymmetric over the whole period.

So what we have are two systems that have very similar potentials; thus we would expect the mechanics of the two systems to be similar. We notice from the distribution with U_{off} in Figure 6b and game A in Figure 2 that the distribution is the same, namely, a normal distribution. Hence, we can

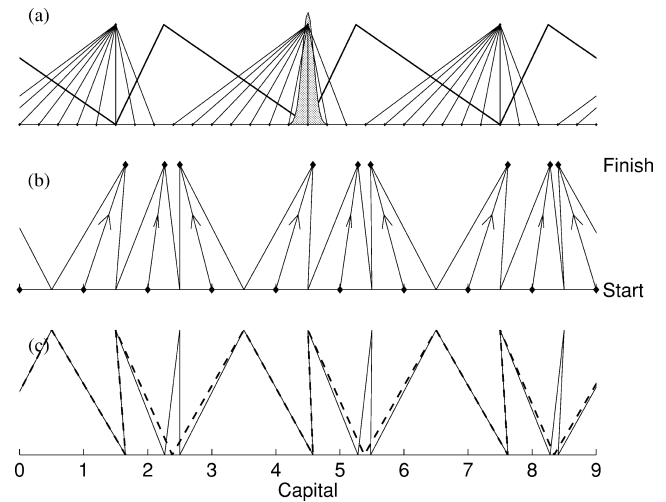

FIG. 7. The ratchet potential in (a) demonstrates where particles will diffuse to if uniformly placed on the potential. Tracing the particles from starting to finishing points gives an indication of the potential. The simulations averaged 10,000 trails of $B_0^{20}(x)$ with $x = \{0, \dots, 9\}$. (b) shows this technique applied to game B with the potentials drawn in. By removing the narrow spikes, a clearer picture of the potential is achieved as seen by the dashed line in (c).

consider the potential of game B to be analogous to U_{on} . A brief explanation of how the potentials of the two games work follows. Assuming that we initially start with game B, the capital is held at particular values by the minima of the potential wells as shown in Figure 8a. Switching to game A allows the trapped capital to “diffuse” or randomly walk, resulting in a normal distribution shown in (b). The longer game A is played, the broader the distribution becomes. When game B is played again, the potential causes the capital to move to the appropriate well as seen in (c). Increasing ε has the effect of causing the normal distribution when playing game A to slide backwards similar to that for the ratchet as shown in Figure 6.

Note that although the potentials are similar, there is a major difference between Parrondo’s ratchet and the Brownian ratchet. The latter is continuous in time and space; that is, the particles can exist at any real displacement along the potential, which can also be switched for any real times τ_{on} and τ_{off} . This is different from Parrondo’s ratchet, which is discrete in both the analogous time and space. The capital of the games is quantized, and only integer numbers of games can be played. The mode of analysis for the Brownian ratchet is via continuous variables in the Fokker–Planck equation (FPE), whereas for the Parrondo ratchet it is via discrete-time Markov chain (DTMC) analysis.

Now that we have the game B potential, it is interesting how it compares to playing the actual

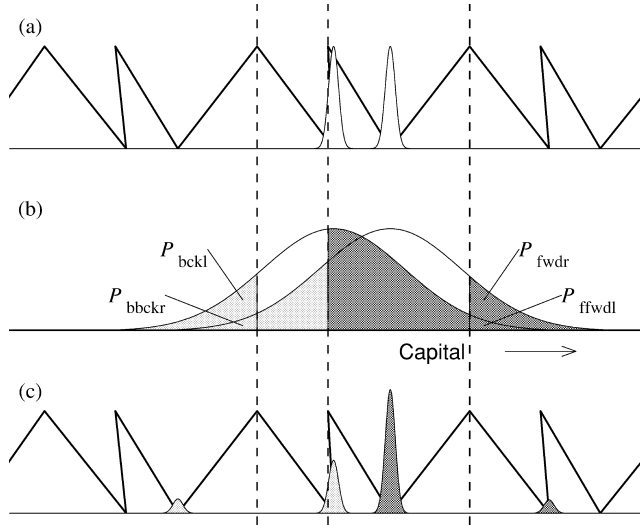

FIG. 8. This shows how switching between game A and B causes an increase in capital. The asymmetry of the potential is due to the rules of game B given in (5). The net flow of capital is to the right, that is, in the forward direction.

games. Instead of playing the actual games to get results, we can use the potentials of the games. Game A is played using the normal distribution pattern given by (4), which enables the number of times game A is played in a row to be varied via use of the variance and mean. Game B is played using the potential derived in Figure 7c. By playing $(A_0^a B_0^b)^n$ for $b = \{1, 2\}$ and increasing a , we expect the gain to decrease as seen in Figure 9a. This agrees with Figure 4 when $b = \{1, 2\}$. Figure 9b shows the probability current using $J = (P_{\text{ffwdl}} + P_{\text{fwdr}}) - (P_{\text{bbckr}} + P_{\text{bckl}})$ while increasing a ; see Figure 8b for probability definitions. The shape of the resulting probability current is similar to those published for Brownian ratchet systems (Berdishevsky and Gitterman, 1998; Faucheux et al., 1995; Magnasco, 1993).

During the discussion of Parrondo’s paradox, we have often compared the mechanics to that of the Brownian ratchet by analogy. Table 1 shows the relationships between some of the quantities used.

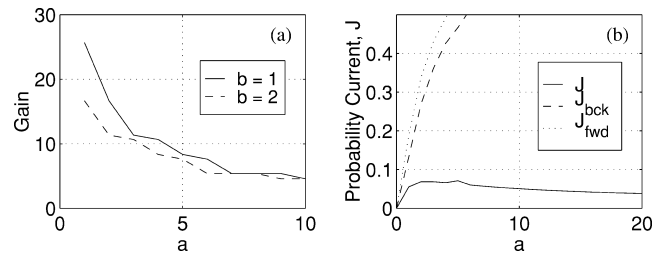

FIG. 9. This shows playing the games just using the potentials derived from the games. (a) This plots the gain when playing $(A_0^a B_0^b)^{500/a+b}(0)$ with $b = \{1, 2\}$ while increasing a . (b) The probability currents: there is an optimal, nonzero value of a that gives maximum movement of capital.

4. CONCLUSION

By switching between two states, a Brownian ratchet can move particles “uphill” or up in potential, even if particles ordinarily move down in each of the states. This is the so-called flashing ratchet. Parrondo’s inspiration was to recognize that the two states could be likened to two losing games A

TABLE 1
The relationship between quantities used for Parrondo’s paradox and the Brownian ratchet

Quantity	Brownian ratchet	Parrondo’s paradox
Source of potential	Electrostatic, gravity	Rules of games
Duration	Time	Number of games played
Potential	Potential field gradient	Parameter ε
Switching	U_{on} and U_{off} applied	Games A and B played
Switching durations	for τ_{on} and τ_{off}	a and b
Measurement/output	Displacement x	Capital or gain
External energy	Switching U_{on} and U_{off}	Alternating games
Potential asymmetry	Depends on α	Branching of B to p_1 or p_2

and B. When appropriate games are then alternated, a winning expectation is attained. We have developed this analogy further and have analyzed the games by a number of simulations. A number of characteristics of the resulting graphs were heuristically explained by using the Brownian ratchet model.

We introduced a novel method for tracing the shape of a potential profile from the paths of the particles. Using this technique, we were able to determine the notional potentials for Parrondo's game; these proved invaluable for a qualitative explanation of a number of observations.

Finally, we speculate that increased understanding of Parrondo's discrete ratchet may have applications in signal processing, biology and perhaps in economics. A statistical interpretation of the central result is that the birth and death processes A_ϵ^n and B_ϵ^n tend to be decreasing, whereas $(A_\epsilon^a B_\epsilon^b)^n$ is, surprisingly, increasing. This may also be a useful type of model of interest in population genetics.

ACKNOWLEDGMENTS

This work was funded by the Australian Research Council. Thanks to an anonymous reviewer who suggested the notation that we have adopted to represent the order that the games are played. Deepest thanks are due to Professor Peter Taylor, Department of Applied Mathematics, University of Adelaide, and Professor Juan M. R. Parrondo, Universidad Complutense, Spain, for helpful discussion.

REFERENCES

ABBOTT, D., DAVIS, B. R. and PARRONDO, J. M. R. (1999). The problem of detailed balance for the Feynman-Smoluchowski engine (FSE) and the multiple pawl paradox. In *Proceedings of the Second International Conference on Unsolved Problems of Noise and Fluctuations* (D. Abbott and L. B. Kiss, eds.) American Institute of Physics, Adelaide, Australia. To appear.

ASTUMIAN, R. D. and BIER, M. (1994). Fluctuation driven ratchets: molecular motors. *Phys. Rev. Lett.* **72** 1766–1769.

ASTUMIAN, R. D. (1997). Thermodynamics and kinetics of a Brownian motor. *Science* **276** 917–922.

BERDICHEVSKY, V. and GITTERMAN, M. (1998). Stochastic resonance and ratchets—new manifestations. *Phys. A* **249** 88–95.

BIER, M. (1997a). Brownian ratchets in physics and biology. *Contemp. Phys.* **38** 371–379.

BIER, M. (1997b). A motor protein model and how it relates to stochastic resonance, Feynman's ratchet, and Maxwell's demon. In *Stochastic Dynamics* **386** 81–87. Springer, Berlin.

DOERING, C. R. (1995). Randomly rattled ratchets. *Nuovo Cimento* **17D** 685–697.

FAUCHEUX, L. P., BOURDIEU, L. S., KAPLAN, P. D. and LIBCHABER, A. J. (1995). Optical thermal ratchet. *Phys. Rev. Lett.* **74** 1504–1509.

FEYNMAN, R. P., LEIGHTON, R. B. and SANDS, M. (1963). *The Feynman Lectures on Physics* **1** 46.1–46.9. Addison-Wesley, Reading, MA.

GAMMAITONI, L., HÄNGGI, P., JUNG, P. and MARCHESONI, F. (1998). Stochastic resonance. *Rev. Modern Phys.* **70** 223–287.

GRIMMETT, G. R. and STIRZAKER, D. R. (1982). *Probability and Random Processes*. Oxford Univ. Press.

HÄNGGI, P. and BARTUSSEK, R. (1996). Brownian rectifiers: how to convert Brownian motion into directed transport. *Nonlinear Physics of Complex Systems—Current Status and Future Trends. Lecture Notes in Phys.* **476** 294–308. Springer, Berlin.

HUGHES, B. D. (1995). *Random Walks and Random Variables* **1**. Oxford Univ. Press.

MAGNASCO, M. O. (1993). Forced thermal ratchets. *Phys. Rev. Lett.* **71** 1477–1481.

PARRONDO, J. M. R. (1997). Universidad Complutense, Madrid, Spain. Private communication.

PARRONDO, J. M. R. and ESPAÑOL, P. (1996). Criticism of Feynman's analysis of the ratchet as an engine. *Amer. J. Phys.* **64** 1125–1130.

ROUSSELET, J., SALOME, L., AJDARI, A. and PROST, J. (1994). Directional motion of Brownian particles induced by a periodic asymmetric potential. *Nature* **370** 446–448.

SHLESINGER, M. F. (1996). A brief history of random processes. In *Proceedings of the First International Conference on Unsolved Problems of Noise* (C. R. Doering, L. B. Kiss and M. F. Shlesinger, eds.) 3–10. World Scientific, Szeged, Hungary.

VON SMOLUCHOWSKI, M. (1912). Experimentall nachweisbare, der üblichen Thermodynamik widersprechende Molekularphänomene. *Physikalische Zeitschrift* **13** 1069–1080.