

## Realization of simple Lie algebras via Hall algebras of tame hereditary algebras

Dedicated to Professor Takeshi Sumioka on the occasion of his 60-th birthday

By Hideto ASASHIBA

(Received Mar. 17, 2003)

**Abstract.** We realize simple complex Lie algebras as quotient Lie algebras defined via Hall algebras of tame hereditary algebras.

Let  $A$  be a finite-dimensional hereditary algebra over a finite field  $k$  with  $q$  elements, and consider the free abelian group  $\mathcal{H}(A)$  with basis the isoclasses of finite  $A$ -modules. Then by Ringel [13]  $\mathcal{H}(A)$  turns out to be an associative ring with identity, called the *Hall algebra* of  $A$ , with respect to the multiplication whose structure constants are given by the numbers of filtrations of modules with factors isomorphic to modules that are multiplied (see section 1 for details). The free abelian subgroup  $\bar{L}(A)$  of  $\mathcal{H}(A)$  with basis the isoclasses of finite indecomposable  $A$ -modules becomes a Lie subalgebra modulo  $q - 1$  whose Lie bracket is given by the commutator. It would be interesting to realize all types of simple (complex) Lie algebras using this Lie bracket given by the commutator of the Hall multiplication.

Along this line, Ringel [14] realized the positive part of the simple Lie algebra  $\mathfrak{g}(A)$  for each Dynkin type  $A$ . Further Peng and Xiao [10] realized the all types of simple Lie algebras by the so-called root categories of finite-dimensional representation-finite hereditary algebras. But the Lie bracket was not completely given by the above type, because the root category  $\mathcal{R}$  provides only the positive and the negative parts. The Hall multiplication was used to define the Lie bracket only inside  $\mathcal{R}$ , and when the bracket should not be closed in  $\mathcal{R}$  the definition was changed. In [1] we succeeded to realize general linear algebras and special linear algebras (i.e. the simple Lie algebras of type  $A_n$ ) by this Lie bracket defined on cyclic quiver algebras. In this realization also the Cartan subalgebra was naturally provided together with the positive and the negative parts. The purpose of this paper is to give a way how to realize all types of simple Lie algebras by the Lie bracket given by the Hall multiplication, in particular to give explicit realization of simple Lie algebras of type  $D_n$ . Here we use Hall algebras of tame hereditary algebras (affine quiver algebras in the simply-laced case), which were well studied by Ringel [15] and Peng and Xiao [11].

### 1. Preliminaries.

Throughout this note  $k$  is a finite field of cardinality  $q$ . For a  $k$ -algebra  $A$ , we denote by  $\text{mod } A$  the category of finite-dimensional (left)  $A$ -modules, and by  $\text{ind } A$  the

full subcategory of  $\text{mod } A$  consisting of indecomposable modules. For a field extension  $E$  of  $k$ , we set  $V^E := V \otimes_k E$  for all  $k$ -vector spaces  $V$ . We take an algebraic closure  $\bar{k}$  of  $k$ , and set  $\Omega = \Omega_A$  to be the set of all finite field extensions  $E$  of  $k$  contained in  $\bar{k}$  such that  $(\text{End}_A S)^E$  is a field for all simple  $A$ -modules  $S$ . Then since there are only finitely many isoclasses of simple  $A$ -modules,  $\Omega$  is an infinite set. For an  $A$ -module  $M$ ,  $\text{top } M := M/\text{rad } M$ ,  $\text{soc } M$  and  $l(M)$  denote the top, the socle and the composition length of  $M$ , respectively. The set of isoclasses of a skeletally small category  $\mathcal{C}$  is denoted by  $[\mathcal{C}]$ , e.g.,  $[\text{mod } A]$  denotes the set of isoclasses of modules in  $\text{mod } A$ . For each isoclass  $\alpha \in [\text{mod } A]$  we choose a module  $M(\alpha) \in \alpha$  once for all, and the isoclass containing a module  $M$  is denoted by  $[M]$ . For a set  $E$ ,  $|E|$  denotes the cardinality of  $E$ . For  $\alpha, \beta, \gamma \in [\text{mod } A]$ , we set

$$\mathcal{F}_{\alpha,*}^\gamma := \{X \leq M(\gamma) \mid M(\gamma)/X \cong M(\alpha)\},$$

$$\mathcal{F}_{*,\beta}^\gamma := \{X \leq M(\gamma) \mid X \cong M(\beta)\},$$

$$\mathcal{F}_{\alpha,\beta}^\gamma := \mathcal{F}_{\alpha,*}^\gamma \cap \mathcal{F}_{*,\beta}^\gamma,$$

and the cardinality of these are denoted by  $F_{\alpha,*}^\gamma, F_{*,\beta}^\gamma$ , and  $F_{\alpha,\beta}^\gamma$ , respectively. The set of positive integers is denoted by  $N$ . For a ring  $R, R^\times$  denotes the set of invertible elements of  $R$ . By  $\delta_{ij}$  we denote the Kronecker's symbol, i.e.,  $\delta_{ij} = 1$  if  $i = j$ , and  $\delta_{ij} = 0$  if  $i \neq j$ . For an abelian group  $L$ , we set  $L^{\mathbf{C}} := L \otimes_{\mathbf{Z}} \mathbf{C}$ . For a Lie algebra  $L$ , we set  $U(L)$  to be the universal enveloping algebra, and for elements  $x_1, \dots, x_n$  of  $L$ , we set

$$[x_1, x_2, x_3, \dots, x_n] := [[\dots [[x_1, x_2], x_3], \dots], x_n].$$

Let  $A$  be a finitely generated  $k$ -algebra. Then as shown in Ringel [13]  $A$  is a *finitary* ring, i.e.,  $\text{Ext}_A^1(X, Y)$  is a finite group for all finite  $A$ -modules  $X, Y$ . Recall first that the free abelian group  $\mathcal{H}(A)$  with basis  $\{u_\alpha\}_{\alpha \in [\text{mod } A]}$  together with the multiplication defined by

$$u_\alpha u_\beta := \sum_{\gamma \in [\text{mod } A]} F_{\alpha\beta}^\gamma u_\gamma$$

is called the *integral Hall algebra* of  $A$ . By [13]  $\mathcal{H}(A)$  is an associative ring with the identity  $1 = u_{[0]}$ . Now let  $\bar{L}(A)$  be the free abelian subgroup of  $\mathcal{H}(A)$  with basis  $\{u_\alpha\}_{\alpha \in [\text{ind } A]}$ . We set  $\mathcal{H}(A)_{(a)} := \mathcal{H}(A)/a\mathcal{H}(A)$  and  $\bar{L}(A)_{(a)} := \bar{L}(A)/a\bar{L}(A)$  for each integer  $a$ , and denote elements  $x + a\bar{L}(A)$  of  $\bar{L}(A)/a\bar{L}(A)$  ( $x \in \bar{L}(A)$ ) simply by  $x$ . Then we have the following by Ringel [16, Proposition 3] (see also Ringel [15, Proposition 1]).

LEMMA 1.1. *The free  $\mathbf{Z}/(q-1)\mathbf{Z}$ -module  $\bar{L}(A)_{(q-1)}$  is a Lie subalgebra of  $\mathcal{H}(A)_{(q-1)}$  over  $\mathbf{Z}/(q-1)\mathbf{Z}$  with the Lie bracket*

$$[u_\alpha, u_\beta] = \sum_{\gamma \in [\text{ind } A]} (F_{\alpha\beta}^\gamma - F_{\beta\alpha}^\gamma) u_\gamma$$

for each  $\alpha, \beta \in [\text{ind } A]$ .

We record a construction of the degenerate composition Lie algebra  $L(A)_1$  for a finite-dimensional hereditary  $k$ -algebra  $A$  following Peng and Xiao [11], which realizes the positive part of every symmetrizable Kac-Moody algebra.

Let  $A$  be a finite-dimensional hereditary  $k$ -algebra, and  $\{S_1, \dots, S_n\}$  a complete set of representatives of isoclasses of simple  $A$ -modules. By Lemma 1.1,  $\bar{L}(A^E)_{(|E|-1)}$  is a Lie subalgebra of  $\mathcal{H}(A^E)_{(|E|-1)}$  over  $\mathbf{Z}/(|E|-1)\mathbf{Z}$  for each  $E \in \Omega$ . Consider the direct product of Lie algebras

$$\Pi := \prod_{E \in \Omega} \bar{L}(A^E)_{(|E|-1)}$$

and write  $u_{[X]} := (u_{[X^E]})_{E \in \Omega} \in \Pi$  for  $A$ -modules  $X$  such that  $X^E$  is indecomposable for all  $E \in \Omega$  (e.g. simple modules). (All *exceptional* modules  $X$ , i.e., indecomposable modules  $X$  with  $\text{Ext}_A(X, X) = 0$ , satisfy this condition because  $\text{End}_A(X) \cong \text{End}_A(S_i)$  for some  $i$  by Ringel [18, Corollary 1]. This was used to prove [11, Theorem 4.7], which we use.) Then the Lie subalgebra  $L(A)_1$  of  $\Pi$  generated by  $\{u_{[S_i]} \mid i = 1, \dots, n\}$  is called the *degenerate composition Lie algebra* of  $A$ .

Recall that a symmetrizable generalized Cartan matrix  $C$  is attached to the algebra  $A$  as follows: Set first  $C_{ii} := 2$  for all  $i \in \{1, \dots, n\}$ . Let  $i \neq j$  be in  $\{1, \dots, n\}$ . Then  $\text{Ext}_A^1(S_i, S_j) = 0$  or  $\text{Ext}_A^1(S_j, S_i) = 0$ . Assume, say,  $\text{Ext}_A^1(S_j, S_i) = 0$ . Then we set

$$C_{ij} := -\dim_{\text{End } S_i} \text{Ext}_A^1(S_i, S_j),$$

$$C_{ji} := -\dim_{\text{End } S_j} \text{Ext}_A^1(S_i, S_j).$$

Then  $C$  is a generalized Cartan matrix. Put  $d_i := \dim_k \text{End } S_i$  for all  $i$ . Then we have  $d_i C_{ij} = d_j C_{ji}$  for all  $i, j \in \{1, \dots, n\}$ , which shows that  $C$  is symmetrizable. Note that conversely any symmetrizable generalized Cartan matrix is obtained in this way using some finite-dimensional hereditary  $k$ -algebra  $A$ . Namely, if  $\Delta$  is the valued graph expressing a given symmetrizable generalized Cartan matrix  $C$ , then  $A$  is given by the tensor algebra of a species of type  $\Delta$  (see Gabriel [3]; or a realization of  $\Delta$ , see Dlab-Ringel [2] for details).

For a symmetrizable generalized Cartan matrix  $C$  we denote by  $\mathfrak{g}(C)$  the complex Kac-Moody algebra of  $C$  and by  $\mathfrak{n}_+(C)$  (resp.  $\mathfrak{n}_-(C)$ ) the positive (resp. negative) part of  $\mathfrak{g}(C)$ . Then by a part of [11, Theorem 4.7] we have the following (see also Ringel [15, Theorems 2 and 3]).

**THEOREM 1.2.** *Let  $A$  be a finite-dimensional hereditary  $k$ -algebra,  $\{S_1, \dots, S_n\}$  a complete set of representatives of isoclasses of simple  $A$ -modules,  $C$  the symmetrizable generalized Cartan matrix of  $A$ , and  $e_1, \dots, e_n$  the Chevalley generators of  $\mathfrak{n}_+(C)$ . Then the correspondence  $u_{[S_i]} \otimes 1 \mapsto e_i$  for all  $i$  defines an isomorphism  $L(A)_1^C \rightarrow \mathfrak{n}_+(C)$  of complex Lie algebras.*

In particular, the theorem above gives realization of  $\mathfrak{n}_+(\Delta)$  via Hall algebras for all the affine graphs  $\Delta$ .

**2. Realization of simple Lie algebras.**

PROPOSITION 2.1. *Let  $\Delta$  be a Dynkin graph with  $n$  vertices,  $\tilde{\Delta}$  the corresponding (nontwisted) affine graph, and  $A$  a hereditary  $k$ -algebra with the generalized Cartan matrix expressed by  $\tilde{\Delta}$ . Then the correspondence  $u_{[S_i]} \otimes 1 \mapsto E_i$  for all  $i = 1, \dots, n + 1$  defines a surjective morphism*

$$\phi : L(A)_1^{\mathbb{C}} \rightarrow \mathfrak{g}(\Delta)$$

of Lie algebras, where  $E_i$  ( $i = 1, \dots, n$ ) are the Chevalley generators of  $\mathfrak{n}_+(\Delta)$  and  $E_{n+1}$  is a lowest root vector of  $\mathfrak{g}(\Delta)$ .

PROOF. This follows from Theorem 1.2 and [8, 7.4]. Set  $\mathcal{L} := \mathbb{C}[t, t^{-1}]$  to be the algebra of Laurent polynomials in an indeterminate  $t$ . Consider the loop algebra  $\mathcal{L}(\mathfrak{g}(\Delta)) := \mathcal{L} \otimes_{\mathbb{C}} \mathfrak{g}(\Delta)$ . Then as in Kac [8, 7.4]  $\mathfrak{n}_+(\tilde{\Delta})$  is contained in  $\mathcal{L}(\mathfrak{g}(\Delta))$ . More precisely,  $e_i := 1 \otimes E_i$  for  $i = 1, \dots, n$  and  $e_{n+1} := t \otimes E_{n+1}$  form the Chevalley generators of  $\mathfrak{n}_+(\tilde{\Delta})$ . Let  $\psi : \mathcal{L}(\mathfrak{g}(\Delta)) \rightarrow \mathfrak{g}(\Delta)$  be the morphism of Lie algebras given by substitution of  $t = 1$ . Then the restriction  $\psi' : \mathfrak{n}_+(\tilde{\Delta}) \rightarrow \mathfrak{g}(\Delta)$  of  $\psi$  is surjective because  $\{E_i \mid i = 1, \dots, n + 1\}$  generates  $\mathfrak{g}(\Delta)$ . The composite of  $\psi'$  and the isomorphism stated in Theorem 1.2 gives the surjective morphism  $\phi$  in the assertion.  $\square$

Keep the notation in the proposition above. Next we compute the kernel of  $\phi$ . We denote the set of vertices of  $\Delta$  (resp.  $\tilde{\Delta}$ ) by  $\Delta_0 := \{1, \dots, n\}$  (resp.  $\tilde{\Delta}_0 := \{1, \dots, n + 1\}$ ). We set  $C := (a_{ij})_{1 \leq i, j \leq n}$  to be the Cartan matrix corresponding to  $\Delta$ . Since  $\tilde{\Delta}$  is nothing else than the underlying valued graph of the valued quiver of  $A$ , dimension vectors of indecomposable  $A$ -modules are naturally identified with positive roots of  $\tilde{\Delta}$ . Those of preprojective and preinjective ones are positive real roots, and those of regular ones include all positive imaginary roots. Set  $w = (w_i)_{1 \leq i \leq n+1}$  to be the minimal positive imaginary root of  $\tilde{\Delta}$ , and  $e_i$  to be the simple root corresponding to  $i$  for each vertex  $i = 1, \dots, n + 1$  of  $\tilde{\Delta}$ . Then  $w' := (w_i)_{1 \leq i \leq n}$  is the highest root of  $\Delta$  and can be identified with  $w - e_{n+1}$ . For a positive real root  $v$  of  $\tilde{\Delta}$ , since the isoclass of indecomposable  $A$ -module with dimension vector  $v$  is unique, we denote it by  $m(v)$ , and set  $M(v) := M(m(v))$  for short. We set  $l := \sum_{i=1}^n w_i - 1$ . Then the following lemma is easily verified.

LEMMA 2.2. *Under the notation above the following hold.*

- (1) *For each  $i \in \Delta_0$  there exists a sequence  $p_i := (p_i(1), \dots, p_i(l))$  of vertices in  $\Delta_0$  such that*
  - (i)  *$w' - e_{p_i(1)} - \dots - e_{p_i(s)}$  is a positive real root of  $\Delta$  for each  $s = 1, \dots, l$ ; and*
  - (ii)  *$w' - e_{p_i(1)} - \dots - e_{p_i(l)} = e_i$ .*
- (2)  *$w \pm e_i$  are positive real roots of  $\tilde{\Delta}$  for all  $i$ .*

We now state our main theorem.

THEOREM 2.3. *Let  $\Delta$  be a Dynkin graph with  $n$  vertices,  $\tilde{\Delta}$  the corresponding (nontwisted) affine graph, and  $A$  a hereditary  $k$ -algebra with the generalized Cartan matrix expressed by  $\tilde{\Delta}$ . Then we have*

$$\mathfrak{g}(\Delta) \cong L(A)_1^{\mathbb{C}} / \langle u_{m(w+e_i)} - r_i u_{m(e_i)} \mid i \in \tilde{\Delta}_0 \rangle$$

for some  $r_1, \dots, r_{n+1} \in \mathbb{Q}$ .

PROOF. Let  $E_i \in \mathfrak{n}_+(\mathcal{A})$ ,  $F_i \in \mathfrak{n}_-(\mathcal{A})$ ,  $H_i := [E_i, F_i]$  ( $i \in \mathcal{A}_0$ ) be Chevalley generators of  $\mathfrak{g}(\mathcal{A})$ . Note that  $-w' = (-w_i)_{1 \leq i \leq n}$  is the lowest root of  $\mathcal{A}$ . Then as easily seen there exists a sequence  $(i_1, \dots, i_{l+1})$  of vertices in  $\mathcal{A}_0$  such that  $[F_{i_1}, \dots, F_{i_{l+1}}]$  is a lowest root vector, where  $F_i$  appears  $w_i$  times for all  $i$ . Hence we may take  $E_{n+1} := [F_{i_1}, \dots, F_{i_{l+1}}]$ . Recall that  $\phi$  is the composite of the isomorphism  $\rho : L(\mathcal{A})_1^{\mathbb{C}} \rightarrow \mathfrak{n}_+(\tilde{\mathcal{A}})$  and the surjective morphism  $\psi' : \mathfrak{n}_+(\tilde{\mathcal{A}}) \rightarrow \mathfrak{g}(\mathcal{A})$ , where  $\rho$  is defined by  $\varepsilon_i := u_{m(e_i)} = u_{[S_i]} \mapsto 1 \otimes E_i$  for all  $i \in \mathcal{A}_0$ ,  $\varepsilon_{n+1} := u_{m(e_{n+1})} = u_{[S_{n+1}]} \mapsto t \otimes E_{n+1}$  and  $\psi'$  is defined by the substitution of  $t = 1$ . Note that  $\mathfrak{n}_+(\mathcal{A}) = t\mathbb{C}[t] \otimes_{\mathbb{C}} (\mathfrak{n}_-(\mathcal{A}) + \mathfrak{h}(\mathcal{A})) + \mathbb{C}[t] \otimes_{\mathbb{C}} \mathfrak{n}_+(\mathcal{A}) \subseteq \mathcal{L}(\mathfrak{g}(\mathcal{A}))$ . Then as easily seen we have  $\text{Ker } \psi' = (t-1)\mathfrak{n}_+(\tilde{\mathcal{A}})$ , which is generated by  $(t-1)(1 \otimes E_i)$  ( $i \in \mathcal{A}_0$ ) and  $(t-1)t \otimes E_{n+1}$  as an ideal of  $\mathfrak{n}_+(\tilde{\mathcal{A}})$ . Therefore we have

$$(2.1) \quad \text{Ker } \phi = \langle \rho^{-1}((t-1)(1 \otimes E_1)), \dots, \rho^{-1}((t-1)(1 \otimes E_n)), \rho^{-1}((t-1)t \otimes E_{n+1}) \rangle.$$

Set  $\zeta_i := u_{m(w-e_i)}$  and  $\eta_i := [\varepsilon_i, \zeta_i]$  for each  $i \in \mathcal{A}_0$ . For each  $i \in \mathcal{A}_0$  take a sequence  $p_i := (p_i(1), \dots, p_i(l))$  of vertices in  $\mathcal{A}_0$  stated in Lemma 2.2. Then we have

- (i)  $(-w + e_{n+1}) + e_{p_i(1)} + \dots + e_{p_i(s)}$  is a negative real root for each  $s = 1, \dots, l$ ; and
- (ii)  $(-w + e_{n+1}) + e_{p_i(1)} + \dots + e_{p_i(l)} = -e_i$ .

And then  $\zeta_i$  (resp.  $F_i$ ) and  $[\varepsilon_{n+1}, \varepsilon_{p_i(1)}, \dots, \varepsilon_{p_i(l)}]$  (resp.  $[E_{n+1}, E_{p_i(1)}, \dots, E_{p_i(l)}]$ ) are nonzero and in the same 1-dimensional root space with root  $w - e_i$  (resp.  $-e_i$ ). Hence there exist  $a_i, b_i \in \mathbb{C}^\times$  such that

$$[\varepsilon_{n+1}, \varepsilon_{p_i(1)}, \dots, \varepsilon_{p_i(l)}] = a_i \zeta_i$$

and

$$[E_{n+1}, E_{p_i(1)}, \dots, E_{p_i(l)}] = b_i F_i.$$

By construction of  $L(\mathcal{A})_1$ , we have  $a_i \in \mathbb{Z}$  for all  $i$ . By Serre relations we see that  $b_i \in \mathbb{Z}$  for all  $i$ . Then for each  $i = 1, \dots, n$  we have

$$\begin{aligned} a_i \rho(\zeta_i) &= \rho[\varepsilon_{n+1}, \varepsilon_{p_i(1)}, \dots, \varepsilon_{p_i(l)}] \\ &= [\rho(\varepsilon_{n+1}), \rho(\varepsilon_{p_i(1)}), \dots, \rho(\varepsilon_{p_i(l)})] \\ &= [t \otimes E_{n+1}, 1 \otimes E_{p_i(1)}, \dots, 1 \otimes E_{p_i(l)}] \\ &= t \otimes b_i F_i \\ &= b_i(t \otimes F_i). \end{aligned}$$

Thus  $\rho(\eta_i) = [\rho(\varepsilon_i), \rho(\zeta_i)] = [1 \otimes E_i, (b_i/a_i)(t \otimes F_i)] = (b_i/a_i)(t \otimes H_i)$ , and

$$\begin{aligned} \rho([\eta_i, \varepsilon_i]) &= (b_i/a_i)[t \otimes H_i, 1 \otimes E_i] \\ &= (b_i/a_i)(t \otimes [H_i, E_i]) \\ &= (2b_i/a_i)(t \otimes E_i). \end{aligned}$$

Hence  $\rho((a_i/2b_i)[\eta_i, \varepsilon_i] - \varepsilon_i) = (t-1)(1 \otimes E_i)$ , i.e.,

$$\rho^{-1}((t-1)(1 \otimes E_i)) = (a_i/2b_i)[\eta_i, \varepsilon_i] - \varepsilon_i.$$

On the other hand, since  $[\eta_i, \varepsilon_i]$  and  $u_{m(w+e_i)}$  are nonzero and in the same 1-dimensional root space, we have

$$[\eta_i, \varepsilon_i] = d_i u_{m(w+e_i)}$$

for some  $d_i \in \mathbf{C}^\times$ . By construction of  $L(A)_1$  we have  $d_i \in \mathbf{Z}$ . As a consequence,

$$\rho^{-1}((t-1)(1 \otimes E_i)) = (a_i d_i / 2b_i) u_{m(w+e_i)} - u_{m(e_i)}.$$

Set  $r_i := 2b_i / a_i d_i \in \mathbf{Q}$ . Then we have

$$(2.2) \quad r_i \rho^{-1}((t-1)(1 \otimes E_i)) = u_{m(w+e_i)} - r_i u_{m(e_i)}.$$

Then for each  $j \in \Delta_0$  we have

$$\begin{aligned} [H_j, E_{n+1}] &= [[H_j, F_{i_1}], F_{i_2}, \dots, F_{i_{l-1}}] + [F_{i_1}, [H_j, F_{i_2}], F_{i_3}, \dots, F_{i_{l-1}}] \\ &\quad + \dots + [F_{i_{l-1}}, \dots, F_{i_{l-2}}, [H_j, F_{i_{l-1}}]] \\ &= - \left( \sum_{i=1}^n a_{ji} w_i \right) E_{n+1}. \end{aligned}$$

Since the Cartan matrix  $C$  is nonsingular, there exists some  $j$  such that

$$c := - \sum_{i=1}^n a_{ji} w_i \neq 0$$

(at least in the simply-laced case, such a  $j$  is unique, and is called the *exceptional* index for the maximal root  $w'$  and  $c = -1$  by [12, 1.1(7)]). Then  $0 \neq [H_j, E_{n+1}] = cE_{n+1}$ , and

$$\begin{aligned} \rho([\eta_j, \varepsilon_{n+1}]) &= [(b_j/a_j)(t \otimes H_j), t \otimes E_{n+1}] \\ &= (b_j/a_j)t^2 \otimes [H_j, E_{n+1}] \\ &= (b_j c/a_j)t^2 \otimes E_{n+1}. \end{aligned}$$

Therefore  $\rho((a_j/b_j c)[\eta_j, \varepsilon_{n+1}] - \varepsilon_{n+1}) = (t-1)t \otimes E_{n+1}$ , thus

$$\rho^{-1}((t-1)t \otimes E_{n+1}) = (a_j/b_j c)[\eta_j, \varepsilon_{n+1}] - \varepsilon_{n+1}.$$

Here since  $[\eta_j, \varepsilon_{n+1}]$  and  $u_{m(w+e_{n+1})}$  are nonzero and in the same 1-dimensional root space, we have

$$[\eta_j, \varepsilon_{n+1}] = d u_{m(w+e_{n+1})}$$

for some  $d \in \mathbf{C}^\times$ . By construction of  $L(A)_1$ , we have  $d \in \mathbf{Z}$ . Set  $r_{n+1} := b_j c / a_j d \in \mathbf{Q}$ . Then we obtain

$$(2.3) \quad r_{n+1} \rho^{-1}((t-1)t \otimes E_{n+1}) = u_{m(w+e_{n+1})} - r_{n+1} u_{m(e_{n+1})}.$$

By (2.1), (2.2) and (2.3) the assertion follows. □

REMARK 2.4. We summarize how to compute the numbers  $r_i$ . First take Chevalley generators  $E_i \in \mathfrak{n}_+(\mathcal{A})$ ,  $F_i \in \mathfrak{n}_-(\mathcal{A})$ ,  $H_i := [E_i, F_i]$  ( $i \in \Delta_0$ ) of  $\mathfrak{g}(\mathcal{A})$ .

- (a) Set  $E_{n+1} := [F_{i_1}, \dots, F_{i_{l+1}}]$ , where  $(i_1, \dots, i_{l+1})$  is a sequence of vertices in  $\Delta_0$  such that  $[F_{i_1}, \dots, F_{i_{l+1}}]$  is a lowest root vector, and  $F_i$  appears  $w_i$  times for all  $i \in \Delta_0$ .
- (b) For each  $i \in \Delta_0$  take a sequence  $p_i := (p_i(1), \dots, p_i(l))$  of vertices in  $\Delta_0$  such that
  - (i)  $w' - e_{p_i(1)} - \dots - e_{p_i(s)}$  is a positive real root of  $\Delta$  for each  $s = 1, \dots, l$ ; and
  - (ii)  $w' - e_{p_i(1)} - \dots - e_{p_i(l)} = e_i$ .
- (c) For each  $i \in \Delta_0$  compute  $a_i, b_i \in \mathbf{Z}^\times$  satisfying the equalities

$$[\varepsilon_{n+1}, \varepsilon_{p_i(1)}, \dots, \varepsilon_{p_i(l)}] = a_i \zeta_i$$

and

$$[E_{n+1}, E_{p_i(1)}, \dots, E_{p_i(l)}] = b_i F_i.$$

We set  $c_i := a_i/b_i$  for all  $i$ .

- (d) For each  $i \in \Delta_0$  compute  $\eta_i := [\varepsilon_i, \zeta_i]$  and the number  $d_i \in \mathbf{Z}^\times$  satisfying the equality

$$[\eta_i, \varepsilon_i] = d_i u_{m(w+e_i)}.$$

- (e) Take an  $i_0 \in \Delta_0$  and compute  $c$  such that  $c := -\sum_{i=1}^n a_{i_0 i} w_i \neq 0$ .
- (f) Compute a  $d \in \mathbf{Z}^\times$  such that  $[\eta_{i_0}, \varepsilon_{n+1}] = d u_{m(w+e_{n+1})}$ .
- (g) Using the data above set  $r_i := 2/c_i d_i$  for all  $i \in \Delta_0$  and  $r_{n+1} := c/c_{i_0} d$ .

REMARK 2.5. The elements  $\bar{u}_{m(e_i)}, c_i \bar{u}_{m(w-e_i)}, c_i \bar{\eta}_i$  ( $i = 1, \dots, n$ ) form Chevalley generators of  $L(A)_1^C/I$ , where  $I = \langle u_{m(w-e_i)} - r_i u_{m(e_i)} \mid i \in \tilde{\Delta}_0 \rangle$  and  $\bar{x} := x + I$  for all  $x \in L(A)_1^C$ .

REMARK 2.6. Note that the set  $\{\bar{u}_{m(v)}, \bar{u}_{m(w-v)}, \bar{\eta}_i \mid v \text{ is a positive root of } \Delta \text{ and } i \in \Delta_0\}$  forms a basis of  $L(A)_1^C/I$ .

### 3. Type $A_n$ .

In this section we compute the numbers  $r_i$  in Theorem 2.3 for simple complex Lie algebras of type  $A_n$ . Simple complex Lie algebras of type  $A_n$  are already realized in [1, Corollary 2.2] by cyclic quiver algebras. Here we give alternative realization using a different orientation of the graph of type  $\tilde{A}_n$ . Since the proof of the theorem for type  $A_n$  (Theorem 3.3) proceeds in the same way as in the case of  $D_n$  (Theorem 4.3), for which we present the proof in detail, we leave the proof to the reader.

#### 3.1. Orientation of type $\tilde{A}_n$ .

Let  $n \in \mathbf{N}$ . Here we take the following quiver  $Q$  of type  $\tilde{A}_n$ :

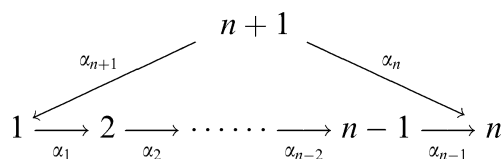

We set  $Q_0$  to be the set  $\{1, \dots, n+1\}$  of vertices of  $Q$ . Let  $A$  be the path  $k$ -algebra of the quiver  $Q$ .

**3.2. Lists of indecomposables for  $\tilde{A}_n$ .**

First we give a list (= complete set of representatives of isoclasses) of indecomposable modules with dimension vectors  $w$  and  $w \pm e_i$  for all  $i \in Q_0$ , which are necessary to compute the numbers  $r_i$ . Here the minimal positive imaginary root  $w = (w_i)_{i \in Q_0}$  is given by  $w_i = 1$  for all  $i \in Q_0$ . These lists are obtained, for instance, by noting that  $A$  is a special biserial algebra. In the following lists each indecomposable module  $V$  with dimension vector  $v = (v_i)_{i \in Q_0}$  is given by vector spaces  $V(i) = k^{v_i}$  for all  $i \in Q_0$  and by linear maps  $V(\alpha_i)$ , each of which is expressed by the matrix with respect to the standard bases of the spaces  $V(i)$ , and  $V$  is denoted by the sequence  $(V(\alpha_1), V(\alpha_2), \dots, V(\alpha_{n+1}))$  of matrices.

List of  $M(w - e_i)$  for  $i \in Q_0$ :

$$\begin{aligned}
 M(w - e_1) &= (0, 1, 1, \dots, 1, 0) \\
 M(w - e_i) &= (1, 1, \dots, 1, 0, 0, 1, 1, \dots, 1) \quad \text{for } 2 \leq i \leq n - 1 \\
 M(w - e_n) &= (1, 1, \dots, 1, 0, 0, 1) \\
 M(w - e_{n+1}) &= (1, 1, \dots, 1, 0, 0)
 \end{aligned}$$

List of indecomposable  $A$ -modules with dimension vector  $w$ :

$$\begin{aligned}
 X_{a:b} &= (1, 1, \dots, 1, b, a) \quad \text{for } (a : b) \in \mathbf{P}_k^1 \\
 Y_i &= (1, 1, \dots, 1, 0, 1, 1, \dots, 1) \quad \text{for } 1 \leq i \leq n - 1.
 \end{aligned}$$

List of  $M(w + e_i)$  for  $i \in Q_0$ :

$$\begin{aligned}
 M(w + e_i) &= (1, 1, \dots, 1, \begin{pmatrix} 1 \\ 0 \end{pmatrix}, (0, 1), 1, 1, \dots, 1) \quad \text{for } 1 \leq i \leq n \\
 M(w + e_{n+1}) &= (1, 1, \dots, 1, (0, 1), (1, 0)).
 \end{aligned}$$

In the lists above, if we replace the field  $k$  by an element  $E \in \Omega$  we obtain indecomposable  $A^E$ -modules, which will be denoted by  $X(E)$  for modules  $X$  in the lists to stress this replacement. Note that  $X(E) \cong X(k)^E$  unless  $X$  is of the form  $X_{a:b}$  with  $(a : b) \in \mathbf{P}_E^1 \setminus \mathbf{P}_k^1$ .

**THEOREM 3.3.** *Let  $n \in \mathbf{N}$  and  $A$  be the path  $k$ -algebra of the quiver  $Q$  in 3.1 of type  $\tilde{A}_n$ . Then we have*

$$\mathfrak{g}(A_n) \cong L(A)_1^C / \langle u_{m(w+e_i)} - (-1)^n u_{m(e_i)} \mid i \in Q_0 \rangle.$$

Namely, the numbers  $r_i$  in Theorem 2.3 are given by  $r_i = (-1)^n$  for all  $i = 1, \dots, n + 1$ . The numbers  $a_i, b_i, c_i, d_i, c$  and  $d$  that are necessary to compute  $r_i$  are given as follows.

$i$	$a_i$	$b_i$	$c_i$	$d_i$
1	$(-1)^n$	1	$(-1)^n$	2
$2, \dots, n - 1$	$(-1)^{n-1-i}$	$(-1)^{i-1}$	$(-1)^n$	2
$n$	1	$(-1)^{n-1}$	$(-1)^{n-1}$	-2



and  $c = d = -1$ . The following gives Chevalley generators of the right hand side:

- Positive part:  $\bar{u}_{m(e_i)}$ ;
- Negative part:  $c_i \bar{u}_{m(w-e_i)}$ ;
- Cartan subalgebra:  $c_i \bar{\eta}_i$ ,

for  $i = 1, \dots, n$ , where  $\eta_i$  are given as follows.

$$\begin{aligned} \eta_1 &= u_{[X_{0:1}]} - u_{[Y_1]}; \\ \eta_i &= u_{[Y_{i-1}]} - u_{[Y_i]} \quad \text{for } i = 2, \dots, n-1; \\ \eta_n &= \left( \sum_{a \in E} u_{[X_{1:a}(E)]} \right)_{E \in \Omega} - u_{[Y_{n-1}]}. \end{aligned}$$

The set  $\{\bar{u}_{m(v)}, \bar{u}_{m(w-v)}, \bar{\eta}_i \mid v \text{ is a positive root of } \Delta \text{ and } i \in \Delta_0\}$  forms a Chevalley basis up to signs.

#### 4. Type $D_n$ .

We next compute the numbers  $r_i$  in Theorem 2.3 for Lie algebras of type  $D_n$ .

##### 4.1. Orientation of type $\tilde{D}_n$ .

Let  $n \geq 4$ . Here we take the following quiver  $Q$  of type  $\tilde{D}_n$ :

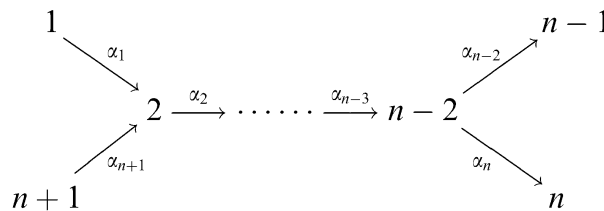

We set  $Q_0$  to be the set  $\{1, \dots, n+1\}$  of vertices of  $Q$ . Let  $A$  be the path  $k$ -algebra of the quiver  $Q$ .

##### 4.2. Lists of indecomposables for $\tilde{D}_n$ .

For the computation we need the following lists of indecomposable  $A$ -modules with dimension vector  $w$  and  $w \pm e_i$  for all  $i \in Q_0$ . First we have  $w = (w_i)_{1 \leq i \leq n+1}$ , where

$$(4.1) \quad w_i = \begin{cases} 1 & \text{if } i = 1, n-1, n, n+1, \\ 2 & \text{otherwise.} \end{cases}$$

These lists are obtained for instance by one-point extension technique explained in [12, 3.4]. In the following lists each indecomposable module  $V$  with dimension vector  $v = (v_i)_{i \in Q_0}$  is given as before by vector spaces  $V(i) = k^{v_i}$  for all  $i \in Q_0$  and by linear maps  $V(\alpha_j)$ , each of which is expressed by the matrix with respect to the standard bases of the spaces  $V(i)$ , and  $V$  is denoted by  $\left( \begin{matrix} V(\alpha_1) & & & & & \\ & V(\alpha_2) & & & & \\ & & \dots & & & \\ & & & V(\alpha_{n-3}) & & \\ & & & & V(\alpha_{n-2}) & \\ & & & & & V(\alpha_n) \end{matrix} \right)$ . We denote the standard basis of  $V(i)$  by  $x_i, (x_i, x'_i)$  or  $(x_i, x'_i, x''_i)$  according as  $\dim V(i) = 1, 2$ , or  $3$ .





PROOF. We compute the numbers  $r_i$  following the procedure stated in Remark 2.4.

(a) By looking at the form (4.1) of  $w$  we obtain

$$E_{n+1} = [F_1, F_2, \dots, F_n, F_{n-2}, F_{n-3}, \dots, F_3, F_2].$$

(b) Again by looking at (4.1) we obtain the sequences  $p_i$  as follows.

$$p_i = \begin{cases} (2, 3, \dots, n, n-2, n-3, \dots, 3, 2) & \text{if } i = 1, \\ (2, 3, \dots, n, n-2, n-3, \dots, i+1, 1, 2, \dots, i-1) & \text{if } 2 \leq i \leq n-2, \\ (2, 3, \dots, n-2, n, 1, 2, \dots, n-2) & \text{if } i = n-1, \\ (2, 3, \dots, n-2, n-1, 1, 2, \dots, n-2) & \text{if } i = n. \end{cases}$$

(c) Using the list of modules  $M(w - e_i)$  we easily obtain the values of  $a_i$  as follows.

$$a_i = \begin{cases} (-1)^{n-1} & \text{if } i = 1, \\ (-1)^{n-1-i} & \text{if } 2 \leq i \leq n-2, \\ 1 & \text{if } i = n-1, n. \end{cases}$$

By induction on  $2 \leq s \leq n-3$  it is easy to show the following:

$$\begin{aligned} [E_{n+1}, E_2, E_3, \dots, E_s] &= [F_1, F_2, \dots, F_{s-1}, F_{s+1}, \dots, F_n, F_{n-2}, F_{n-3}, \dots, F_s] \\ &\quad + [F_1, F_2, \dots, F_n, F_{n-2}, F_{n-3}, \dots, F_{s+1}]. \end{aligned}$$

Using this we easily obtain the values of  $b_i$  as follows.

$$b_i = \begin{cases} 1 & \text{if } i = 1, \\ (-1)^{i-1} & \text{if } 2 \leq i \leq n-2, \\ (-1)^n & \text{if } i = n-1, n. \end{cases}$$

Therefore  $c_i := a_i/b_i$  are given as follows.

$$c_i = \begin{cases} (-1)^{n-1} & \text{if } i = 1, n-1, n, \\ (-1)^n & \text{otherwise.} \end{cases}$$

(d) Using the list of indecomposable  $A$ -modules with dimension vector  $w$  we first obtain the elements  $\eta_i$  as stated in the theorem. Indeed, we have

$$\eta_1 = A_{0:1}u_{[X_{0:1}]} + \sum_{a \in k} A_{1:a}u_{[X_{1:a}]} + \sum_{i=2}^{n-2} B_i u_{[Y_i]} + \sum_{i=1}^2 C_i u_{[Z_i]}$$

in  $L(A)_{(q-1)}$ , where  $A_{a:b} := F_{\varepsilon_1, \zeta_1}^{X_{a:b}} - F_{\zeta_1, \varepsilon_1}^{X_{a:b}}$ ,  $B_i := F_{\varepsilon_1, \zeta_1}^{Y_i} - F_{\zeta_1, \varepsilon_1}^{Y_i}$ ,  $C_i := F_{\varepsilon_1, \zeta_1}^{Z_i} - F_{\zeta_1, \varepsilon_1}^{Z_i}$ . Let  $e_i$  be the trivial path corresponding to the vertex  $i \in Q_0$ . Then since  $e_1 \text{ soc } X_{0:1} = 0$ , we have  $\mathcal{F}_{*, \varepsilon_1}^{[X_{0:1}]} = \emptyset$ . Since  $e_1 \text{ top } X_{0:1}$  is 1-dimensional, looking at the dimension vector of modules in  $\mathcal{F}_{\varepsilon_1, * }^{[X_{0:1}]}$  we see that  $\mathcal{F}_{\varepsilon_1, * }^{[X_{0:1}]} \subseteq \{Ax_{n+1} - Ax'_2\}$ . Here  $Ax_{n+1} - Ax'_2 \cong M(w - e_1)$ . Therefore  $\mathcal{F}_{\varepsilon_1, \zeta_1}^{[X_{0:1}]} = \{Ax_{n+1} - Ax'_2\}$ , and we have  $A_{0:1} = 1 - 0 = 1$ . Similarly we have  $A_{1:a} = 1$  for all  $a \in k$ . Next for each  $i$  with  $2 \leq i \leq n-2$  it is easy to see

that  $\mathcal{F}_{*,\varepsilon_1}^{[Y_i]} = \emptyset$  and  $\mathcal{F}_{\varepsilon_1,*}^{[Y_i]} \subseteq \{Ax_{n+1} + Ax_2\}$ . But since  $Ax_{n+1} + Ax_2$  is decomposable, we see that  $\mathcal{F}_{\varepsilon_1,*}^{[Y_i]} = \emptyset$ , and  $B_i = 0$ . In this way we can compute  $C_1 = C_2 = 1$ . Hence

$$\eta_1 = u_{[X_{0:1}]} + \sum_{a \in k} u_{[X_{1:a}]} + u_{[Z_1]} + u_{[Z_2]}$$

in  $\bar{L}(A)_{(q-1)}$ . Therefore we have

$$\eta_1 = u_{[X_{0:1}]} + \left( \sum_{a \in E} u_{[X_{1:a}(E)]} \right)_{E \in \Omega} + u_{[Z_1]} + u_{[Z_2]}$$

in  $L(A)_1$ . The rest is shown similarly. Using these data we can compute  $[\eta_i, \varepsilon_i]$  for  $1 \leq i \leq n$  as follows.

$$[\eta_i, \varepsilon_i] = \begin{cases} -2u_{m(w+e_i)} & \text{if } i = 1, n-1, n \\ 2u_{m(w+e_i)} & \text{otherwise.} \end{cases}$$

Thus

$$d_i = \begin{cases} -2 & \text{if } i = 1, n-1, n \\ 2 & \text{otherwise.} \end{cases}$$

Indeed, for instance,

$$[\eta_1, \varepsilon_1] = [u_{[X_{0:1}]}, \varepsilon_1] + \sum_{a \in k} [u_{[X_{1:a}]}, \varepsilon_1] + [u_{[Z_1]}, \varepsilon_1] + [u_{[Z_2]}, \varepsilon_1]$$

in  $\bar{L}(A)_{(q-1)}$  and

$$\begin{aligned} \mathcal{F}_{*,\varepsilon_1}^{[M(w+e_1)]} &= \emptyset \\ \mathcal{F}_{\varepsilon_1,*}^{[M(w+e_1)]} &= \{V_{c:d} \mid (c : d) \in \mathbf{P}_k^1\}, \end{aligned}$$

where  $V_{c,d} := Ax_{n+1} + Ax'_2 + A(cx_1 + dx'_1)$  for each  $(c, d) \in k^2 \setminus \{(0, 0)\}$ . Note that  $V_{c,d} = V_{c',d'}$  if and only if  $(c : d) = (c' : d')$  in  $\mathbf{P}_k^1$  for all  $(c, d), (c', d') \in k^2 \setminus \{(0, 0)\}$ . Thus we may put  $V_{c:d} := V_{c,d}$ . Now a direct calculation shows that  $V_{0:1} \cong Z_1$ ,  $V_{1:0} \cong X_{0:1}$ ,  $V_{-1:1} \cong Z_2$ ,  $V_{c:1} \cong X_{1:-(c+1)}$  for all  $c \in k \setminus \{0, -1\}$ . Note that  $\{-(c+1) \mid c \in k \setminus \{0, -1\}\} = k \setminus \{0, -1\}$ . Then for any  $X \in \text{ind } A$ , we have

$$F_{\varepsilon, [X]}^{[M(w+e_1)]} = \begin{cases} 1 & \text{if } X \cong X_{0:1}, Z_1, Z_2 \text{ or } X_{1:a} \text{ for some } a \in k \setminus \{0, -1\} \\ 0 & \text{otherwise.} \end{cases}$$

This yields

$$[u_{[X]}, \varepsilon_1] = \begin{cases} -u_{m(w+e_1)} & \text{if } X \cong X_{0:1}, Z_1, Z_2 \text{ or } X_{1:a} \text{ for some } a \in k \setminus \{0, -1\} \\ 0 & \text{otherwise.} \end{cases}$$

Hence  $[\eta_1, \varepsilon_1] = -(q+1)u_{m(w+e_1)} = -2u_{m(w+e_1)}$  in  $\bar{L}(A)_{(q-1)}$ . As a consequence,

$$[\eta_1, \varepsilon_1] = -2u_{m(w+e_1)}$$

in  $L(A)_1$ , and hence  $d_1 = -2$ . The remaining cases are verified similarly.

(e) Since we are in the simply-laced case, we have  $i_0 = 2$  and  $c = -1$ .

(f) Finally we compute  $d$  that satisfies  $[\eta_2, \varepsilon_{n+1}] = du_{m(w+e_{n+1})}$ . The formula for  $\eta_2$  shows  $[\eta_2, \varepsilon_{n+1}] = [u_{[X_{0:1}], \varepsilon_{n+1}}] - [u_{[Y_2], \varepsilon_{n+1}}]$ . Here we have

$$\mathcal{F}_{*, \varepsilon_{n+1}}^{m(w+e_{n+1})} = \emptyset$$

$$\mathcal{F}_{\varepsilon_{n+1}, *}^{m(w+e_{n+1})} = \{V_{c:d} \mid (c : d) \in \mathbf{P}_k^1\},$$

where  $V_{c:d} := Ax_1 + Ax'_2 + A(cx_{n+1} + dx'_{n+1})$ . A direct calculation shows  $V_{0:1} \cong X_{1:0}$ ,  $V_{1:0} \cong X_{0:1}$ ,  $V_{c:1} \cong X_{1:c}$  for each  $c \in k^\times$ , thus for each  $X \in \text{ind } A$  we have

$$F_{\varepsilon_{n+1}, [X]}^{m(w+e_{n+1})} = \begin{cases} 1 & \text{if } X \cong X_{0:1} \text{ or } X_{1:a} \text{ for some } a \in k \\ 0 & \text{otherwise.} \end{cases}$$

Hence  $[\eta_2, \varepsilon_{n+1}] = -u_{m(w+e_{n+1})}$ , and we finally have  $d = -1$ .

(g) By the data above we have  $r_i = 2/c_i d_i = (-1)^n$  for all  $i \in \Delta_0$  and  $r_{n+1} = c/c_2 d = (-1)^n$ . □

EXAMPLE 4.4. We exhibit the indecomposable  $A$ -modules that are used to construct a basis of our realization of the simple Lie algebra of type  $D_5$ . Let  $Q'$  be the quiver

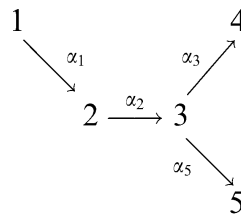

and  $Q$  be the quiver

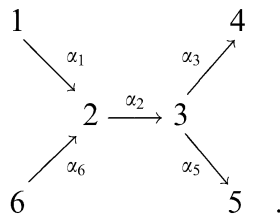

Set  $A' := kQ'$  and as before  $A := kQ$ . Then the basis of the positive part of  $\mathfrak{g}(D_5)$  is given by the set of cosets of indecomposable  $A'$ -modules, which are given by the Auslander-Reiten quiver (AR-quiver for short) of  $A'$  in Figure 1.

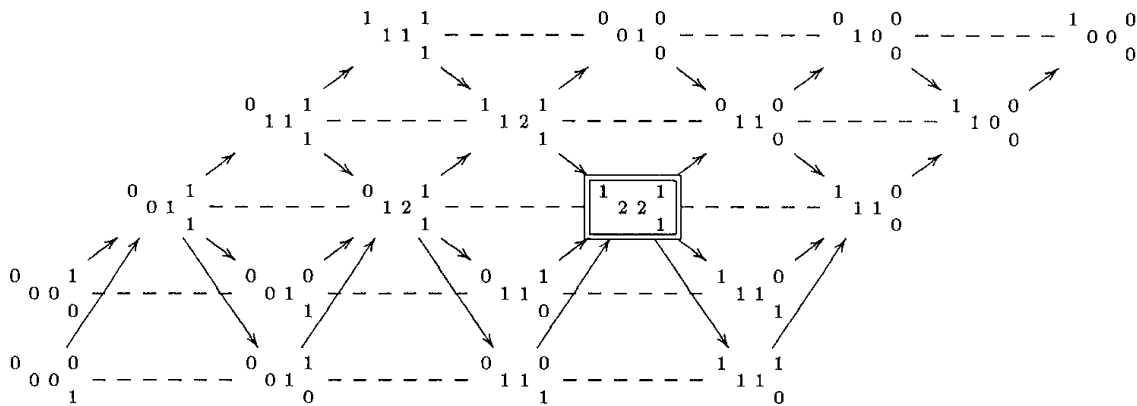

Figure 1. AR-quiver of  $A'$ .

The indecomposable module  $W$  corresponding to the highest root vector is marked by a frame with double line. These indecomposable  $A'$ -modules considered as indecomposable  $A$ -modules are located in different components of the AR-quiver  $\Gamma_A$  of  $A$ . Those that are on the “left” of  $W$  or  $W$  itself go to the preprojective component of  $\Gamma_A$  (Figure 2), among others those that are in the *wings* of  $W$  (see [12, 3.3] for the definition) go to non-homogeneous tubes (Figures 4 and 5, where modules should be identified along the arrows with double lines to form tubes), and the remaining ones go to the preinjective component of  $\Gamma_A$  (Figure 3).

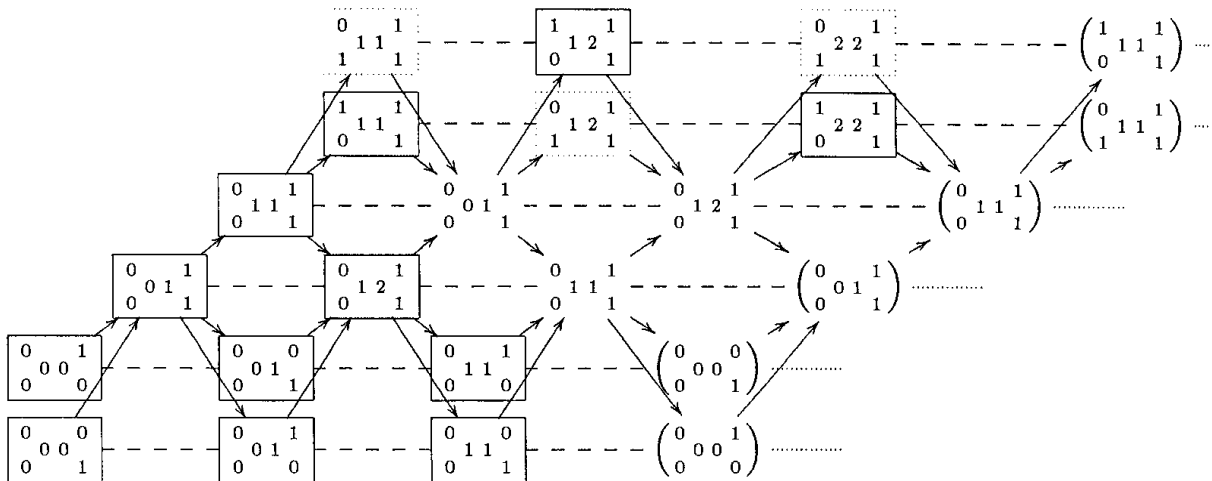

Figure 2. Preprojective component.

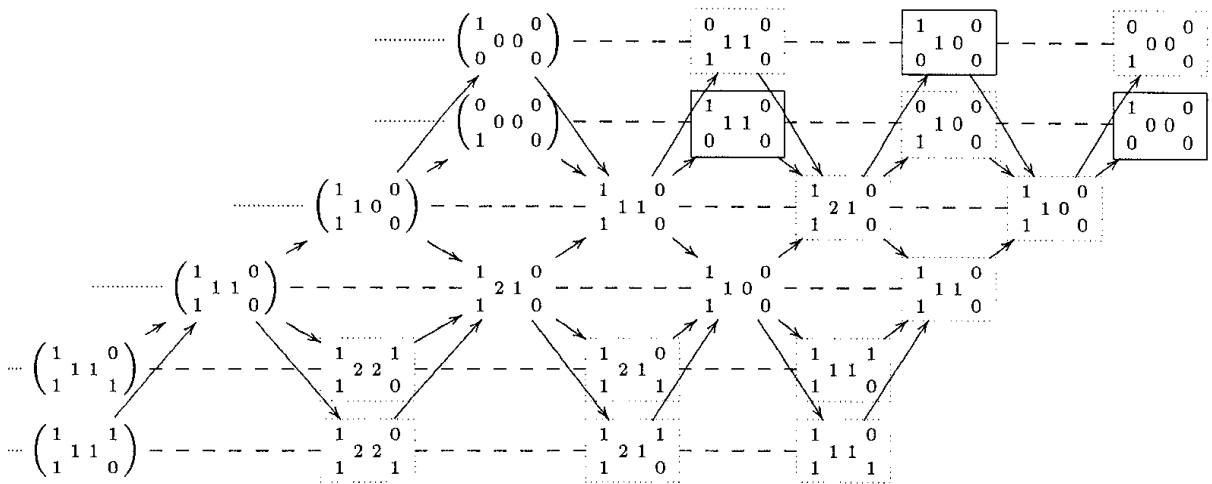

Figure 3. Preinjective component.

In Figures 2–5 indecomposables are denoted by their dimension vectors modulo  $w$  or by the notation in 4.2, and indecomposables marked by solid (resp. dotted) frame give a basis of the positive (resp. negative) part of  $\mathfrak{g}(D_5)$ . The indecomposable modules  $X_{a,b}, Y_2, Y_3, Z_1, Z_2$  of dimension vector  $w$  that are used to give a basis of the Cartan subalgebra of  $\mathfrak{g}(D_5)$  are in the tubes (Figures 4 and 5). Note that in Figure 2 (resp. Figure 3), the right (resp. left) hand side of the modules in parenthesis repeat their left

(resp. right) part, in Figures 4 and 5, the modules under the modules in parenthesis are not used for the representatives of basis elements.

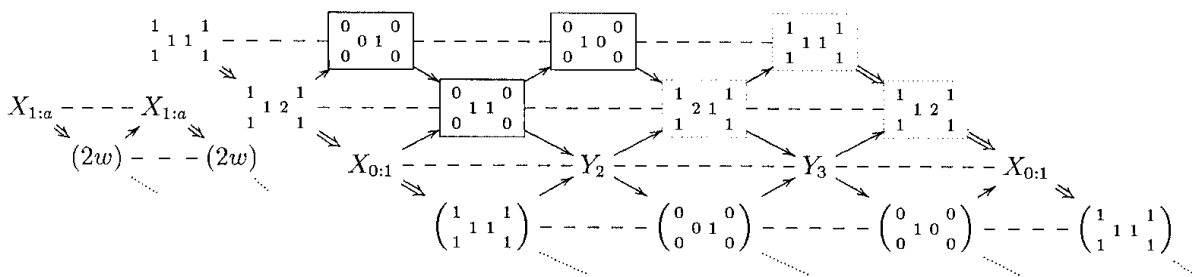

Figure 4. Homogeneous tubes ( $a \neq 0, -1$ ) and tube of rank 3.

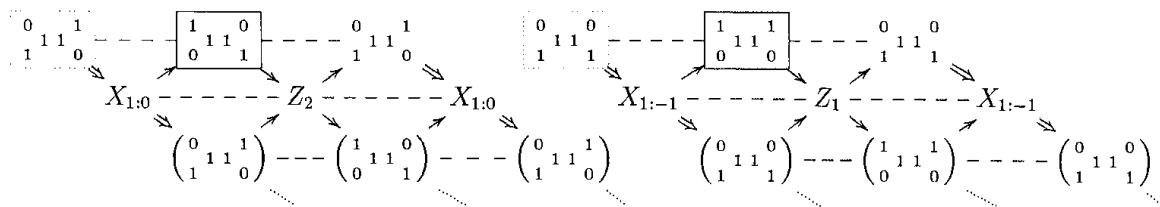

Figure 5. Tubes of rank 2.

**ACKNOWLEDGMENTS.** I would like to thank Professor S. Ariki, Professor Y. Saito and Professor T. Tanisaki for helpful explanation on Lie algebras. In particular, the surjective morphism  $\psi'$ , an essential part of Proposition 2.1, was pointed out by Ariki and Saito when I informed them a theorem [1, Theorem 2.1] on realization of general linear algebras via Hall algebras of cyclic quiver algebras at the 10-th International Conference on Representations of Algebras and Related Topics, Specialized Workshop in 2002 held at Fields Institute in Toronto.

**References**

[1] H. Asashiba, Realization of general and special linear algebras via Hall algebras, to appear in Proc. 10-th International Conference on Representations of Algebras in 2002 held in Toronto.  
 [2] V. Dlab and C. M. Ringel, Indecomposable representations of graphs and algebras, Mem. Amer. Math. Soc., **173**, Amer. Math. Soc., Providence, RI, 1976.  
 [3] P. Gabriel, Indecomposable representations II, Sympos. Math., **XI** (Convegno di Algebra Commutativa, INDAM, Roma, 1971), Academic Press, London, 1973, 81–104.  
 [4] P. Gabriel, The universal cover of a representation-finite algebra, Lecture Notes in Math., **903**, Springer-Verlag, Berlin-New York, 1981, 68–105.  
 [5] J. Guo, The Hall polynomials of a cyclic serial algebra, Comm. Algebra, **23** (2) (1995), 745–751.  
 [6] D. Happel, Triangulated categories in the representation theory of finite dimensional algebras, London Math. Soc. Lect. Note Ser., **119**, Cambridge Univ. Press, 1988.  
 [7] D. Hughes and J. Waschbüsch, Trivial extensions of tilted algebras, Proc. London Math. Soc. (3), **46** (1983), 347–364.  
 [8] V. G. Kac, Infinite dimensional Lie algebras, third edition, Cambridge Univ. Press, 1990.  
 [9] L. Peng and J. Xiao, A realization of affine Lie algebras of type  $\tilde{A}_{n-1}$  via the derived categories of cyclic quivers, CMS Conf. Proc., **18** (1996), 539–554.  
 [10] L. Peng and J. Xiao, Root categories and simple Lie algebras, J. Algebra, **198** (1997), 19–56.



- [11] L. Peng and J. Xiao, Triangulated categories and Kac-Moody algebras, *Invent. Math.*, **140** (2000), 563–603.
- [12] C. M. Ringel, Tame algebras and integral quadratic forms, *Lect. Notes in Math.*, **1099**, Springer, New York, 1984.
- [13] C. M. Ringel, Hall algebras, In: *Topics in Algebra*, Banach Center Publ., **26** (1), Warszawa, 1990, 433–447.
- [14] C. M. Ringel, Hall polynomials for the representation-finite hereditary algebras, *Adv. Math.*, **84** (2), Academic Press, 1990, 137–178.
- [15] C. M. Ringel, From representations of quivers via Hall and Loewy algebras to quantum groups, In: *Proc. Novosibirsk Conf. Algebra 1989*, *Contemp. Math.*, **131** (1992), 381–401.
- [16] C. M. Ringel, Lie algebras arising in representation theory, *London Math. Soc. Lecture Note Ser.*, **168** (1992), 248–291.
- [17] C. M. Ringel, The composition algebra of a cyclic quiver, towards an explicit description of the quantum group of type  $\tilde{A}_n$ , *Proc. London Math. Soc.* (3), **66** (1993), 507–537.
- [18] C. M. Ringel, The braid group action on the set of exceptional sequences of a hereditary artin algebra, *Contemp. Math.*, **171** (1994), 339–352.

Hideto ASASHIBA

Department of Mathematics  
Osaka City University  
3-3-138 Sugimoto, Sumiyoshi-ku  
Osaka, 558  
Japan  
E-mail: asashiba@sci.osaka-cu.ac.jp