

A criterion for reflectiveness of normal extensions*

Andrea Montoli[†] Diana Rodelo Tim Van der Linden[‡]

Abstract

We give a new sufficient condition for the normal extensions in an admissible Galois structure to be reflective. We then show that this condition is indeed fulfilled when \mathbb{X} is the (protomodular) reflective subcategory of \mathcal{S} -special objects of a Barr-exact \mathcal{S} -protomodular category \mathbb{C} , where \mathcal{S} is the class of split epimorphic trivial extensions in \mathbb{C} . Next to some concrete examples where the criterion may be applied, we also study the adjunction between a Barr-exact unital category and its abelian core, which we prove to be admissible.

1 Introduction

In the paper [32] we studied the adjunction between the category of monoids and the category of groups, given by the group completion of a monoid, from the point of view of categorical Galois theory. We showed that the adjunction is admissible with respect to the class of surjective homomorphisms, and we described the central extensions (which turn out to coincide with the normal extensions): they are the so-called *special homogeneous surjections* (see [11]). In the

*This work was partially supported by the Centre for Mathematics of the University of Coimbra – UID/MAT/00324/2013, funded by the Portuguese Government through FCT/MEC and co-funded by the European Regional Development Fund through the Partnership Agreement PT2020.

[†]The first author is a Postdoctoral Researcher of the Fonds de la Recherche Scientifique–FNRS

[‡]The third author is a Research Associate of the Fonds de la Recherche Scientifique–FNRS

Received by the editors in July 2015 - In revised form in January 2016.

Communicated by M. Gran.

2010 *Mathematics Subject Classification* : 20M32, 20M50, 11R32, 19C09, 18F30.

Key words and phrases : categorical Galois theory; admissible Galois structure; central, normal, trivial extension; \mathcal{S} -protomodular category; unital category; abelian object.

subsequent paper [33], we showed that special homogeneous surjections of monoids are reflective amongst surjective homomorphisms. In order to do so, we applied Theorem 4.2 in [25].

The adjunction between monoids and groups is an instance of a more general situation, recently described in [11] and in [12]: the category of monoids is \mathcal{S} -protomodular, with respect to a suitable class \mathcal{S} of points (= split epimorphisms with a fixed splitting), and the category of groups is its *protomodular core* relatively to the class \mathcal{S} (see Section 3). \mathcal{S} -protomodularity allows us to recover, for monoids, relative versions of several important properties of Mal'tsev [14] and protomodular [4] categories, like the Split Short Five Lemma, or the fact that every internal reflexive relation is transitive.

The case of monoids and groups now suggests the following general question: given an adjunction, admissible with respect to regular epimorphisms, between a category with “weak” algebraic properties and a reflective subcategory with “strong” properties, like a protomodular one, such that the big category is \mathcal{S} -protomodular with respect to the class \mathcal{S} of split epimorphic trivial extensions, is it always the case that normal extensions are reflective amongst regular epimorphisms?

The present paper gives an affirmative answer to this question for the case of Barr-exact categories [1]. In order to do this, we needed to obtain a new criterion for reflectiveness of normal extensions, Theorem 2.10: given a Galois structure between Barr-exact categories, which is admissible with respect to classes of regular epimorphisms, the category of normal extensions is reflective in the category of all fibrations (as the morphisms in the chosen class of regular epimorphisms are called) provided that it is closed under coequalizers of reflexive graphs.

The paper is organised as follows. In Section 2 we recall some basic notions of categorical Galois theory and we prove our criterion for reflectiveness of normal extensions. In Section 3 we recall the definition, some properties and some examples of \mathcal{S} -protomodular categories. Section 4 is devoted to the proof that the criterion can be applied in the context of Barr-exact \mathcal{S} -protomodular categories. In Section 5 we describe the concrete examples of the adjunction between monoids and groups and the one between semirings and rings. Section 6 is devoted to the study of a general class of examples, namely the adjunction between a Barr-exact unital [5] category and its *abelian core*. In particular, we prove that, for any finitely cocomplete Barr-exact unital category, the reflection to its abelian core gives an admissible Galois structure, and that the criterion for reflectiveness of normal extensions is applicable to this Galois structure.

2 Reflectiveness of normal extensions

In this section we work towards a general result on reflectiveness of normal extensions in an admissible Galois structure: Theorem 2.10 which says that, if the fibrations in the Galois structure are regular epimorphisms, and normal extensions are closed under coequalisers of reflexive graphs, then the normal extensions are reflective amongst the fibrations.

2.1 Galois structures

We begin by recalling the notion of an (*admissible*) *Galois structure* as well as the concepts of *trivial*, *normal* and *central extension* arising from it [22, 23, 24]. We consider the context of Barr-exact categories [1] and restrict ourselves to fibrations which are regular epimorphisms to avoid some technical difficulties.

Definition 2.2. A **Galois structure** $\Gamma = (\mathbb{C}, \mathbb{X}, I, H, \eta, \epsilon, \mathcal{E}, \mathcal{F})$ consists of an adjunction

$$\mathbb{C} \begin{array}{c} \xrightarrow{I} \\ \perp \\ \xleftarrow{H} \end{array} \mathbb{X}$$

with unit $\eta: 1_{\mathbb{C}} \Rightarrow HI$ and counit $\epsilon: IH \Rightarrow 1_{\mathbb{X}}$ between Barr-exact categories \mathbb{C} and \mathbb{X} , as well as classes of morphisms \mathcal{E} in \mathbb{C} and \mathcal{F} in \mathbb{X} such that:

- (G1) \mathcal{E} and \mathcal{F} contain all isomorphisms;
- (G2) \mathcal{E} and \mathcal{F} are pullback-stable;
- (G3) \mathcal{E} and \mathcal{F} are closed under composition;
- (G4) $H(\mathcal{F}) \subseteq \mathcal{E}$;
- (G5) $I(\mathcal{E}) \subseteq \mathcal{F}$.

We call the morphisms in \mathcal{E} and \mathcal{F} **fibrations** [23]. We moreover assume

- (G6) the classes \mathcal{E} and \mathcal{F} consist of the regular epimorphisms in \mathbb{C} and in \mathbb{X} , respectively.

Finally, we assume that \mathbb{C} has coequalisers of reflexive graphs.

The following definitions are given with respect to a Galois structure Γ .

Definition 2.3. A **trivial extension** is a fibration $f: A \rightarrow B$ in \mathbb{C} such that the square

$$\begin{array}{ccc} A & \xrightarrow{\eta_A} & HI(A) \\ f \downarrow & \lrcorner & \downarrow HI(f) \\ B & \xrightarrow{\eta_B} & HI(B) \end{array}$$

is a pullback. A **central extension** is a fibration f whose pullback $p^*(f)$ along *some* fibration p is a trivial extension. A **normal extension** is a fibration such that its kernel pair projections are trivial extensions.

It is easy to see that trivial extensions are always central extensions and that any normal extension is necessarily a central extension.

Given any object B in \mathbb{C} , we can associate an adjunction

$$(\mathcal{E} \downarrow B) \begin{array}{c} \xrightarrow{I^B} \\ \perp \\ \xleftarrow{H^B} \end{array} (\mathcal{F} \downarrow I(B)),$$

where $(\mathcal{E} \downarrow B)$ denotes the full subcategory of the slice category $(\mathbf{C} \downarrow B)$ determined by the morphisms in \mathcal{E} ; similarly for $(\mathcal{F} \downarrow I(B))$. The functor I^B is just the restriction of I , while H^B sends a fibration $g: X \rightarrow I(B)$ to the pullback

$$\begin{array}{ccc} A & \xrightarrow{\quad} & H(X) \\ H^B(g) \downarrow & \lrcorner & \downarrow H(g) \\ B & \xrightarrow{\eta_B} & HI(B) \end{array}$$

of $H(g)$ along η_B .

Definition 2.4. A Galois structure $\Gamma = (\mathbf{C}, \mathbb{X}, I, H, \eta, \epsilon, \mathcal{E}, \mathcal{F})$ is said to be **admissible** when, for every object B in \mathbf{C} , the functor H^B is full and faithful.

In the presence of an admissible Galois structure, every trivial extension is always a normal extension:

Proposition 2.5 ([25], Proposition 2.4). *If Γ is an admissible Galois structure, then $I: \mathbf{C} \rightarrow \mathbb{X}$ preserves pullbacks along trivial extensions. Hence a fibration is a trivial extension if and only if it is a pullback of some fibration in $H(\mathbb{X})$. In particular, the trivial extensions are pullback-stable, so that every trivial extension is a normal extension. ■*

The admissibility condition of a Galois structure together with the proposition above give the needed conditions to have the reflectiveness of trivial extensions amongst fibrations. In fact, the replete image of the functor H^B is the category of trivial extensions over B , denoted by $\text{Triv}(B)$. Moreover, $\text{Triv}(B)$ is a reflective subcategory of $(\mathcal{E} \downarrow B)$, where $H^B I^B: (\mathcal{E} \downarrow B) \rightarrow \text{Triv}(B)$ is its reflector. So, by Proposition 5.8 in [21], we obtain a left adjoint, called the **trivialisation functor**

$$\text{Triv}: \text{Fib}(\mathbf{C}) \rightarrow \text{Triv}(\mathbf{C}),$$

to the inclusion of the category $\text{Triv}(\mathbf{C})$ of trivial extensions in \mathbf{C} into the full subcategory $\text{Fib}(\mathbf{C})$ of the category of arrows in \mathbf{C} determined by the fibrations.

2.6 Reflectiveness of normal extensions

Given an admissible Galois structure Γ as in Definition 2.4 and an object B in \mathbf{C} , we denote by $\text{Norm}(B)$ the full subcategory of $(\mathcal{E} \downarrow B)$ determined by the normal extensions over B . When it exists, the left adjoint to the inclusion functor $\text{Norm}(B) \hookrightarrow (\mathcal{E} \downarrow B)$ will be denoted by $\text{Norm}: (\mathcal{E} \downarrow B) \rightarrow \text{Norm}(B)$ and called the **normalisation functor (over B)**. We also write

$$\text{Norm}: \text{Fib}(\mathbf{C}) \rightarrow \text{Norm}(\mathbf{C})$$

for the left adjoint to the inclusion $\text{Norm}(\mathbf{C}) \hookrightarrow \text{Fib}(\mathbf{C})$ (where $\text{Norm}(\mathbf{C})$ is the category whose objects are the normal extensions in \mathbf{C}) which exists as soon as the normalisation functors over all objects B exist (again by Proposition 5.8 in [21], using that normal extensions are stable under pullback).

We use the construction proposed in [17] and prove that it does indeed provide us with a normalisation functor as soon as the Galois structure Γ is admissible and satisfies the following condition:

(G7) $\text{Norm}(\mathbb{C})$ is closed under coequalisers of reflexive graphs in $\text{Fib}(\mathbb{C})$.

This approach is related to the results in [16] where the problem of reflectiveness of normal extensions is studied in a much more general setting. Our present paper and [16] were written independently and around the same, but with a different purpose in mind. Ours was to provide simple applications of the construction in 2.7 below—essentially a simple version of the one proposed in [13], which strictly speaking cannot be applied in the current context.

2.7 The construction

Given a fibration $f: A \rightarrow B$, we pull it back along itself, then we take kernel pairs vertically as on the left hand side of the diagram in Figure 1. We apply the trivialisation functor to obtain the upper right part of the diagram, then we take the coequaliser \underline{f} on the right to get the morphism $\text{Norm}(f)$ and the comparison η_f^{Norm} . The normality of $\text{Norm}(f)$ comes from condition (G7) and the fact that all trivial extensions are normal extensions (Proposition 2.5).

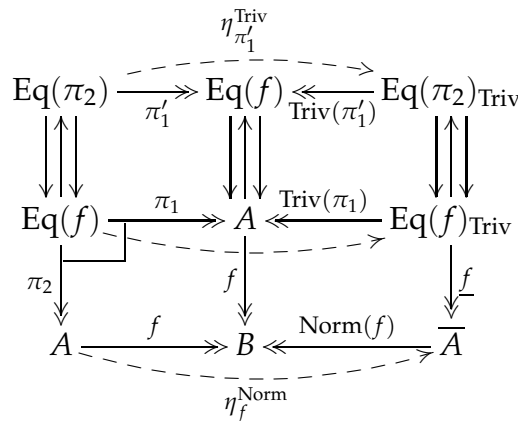

Figure 1: The construction of $\text{Norm}(f)$

2.8 The universal property

Let us prove that the extension $\text{Norm}(f)$ is universal amongst all normal extensions over B . Suppose that $f = g \circ \alpha$, where $g: C \rightarrow B$ is a normal extension. First note that all steps of the construction are functorial. Next, since g is a normal extension, we have $\text{Norm}(g) = g$, $\bar{C} = C$ and $\eta_g^{\text{Norm}} = 1_C$. So we get an induced morphism $\bar{\alpha}: \bar{A} \rightarrow C$ such that $g \circ \bar{\alpha} = \text{Norm}(f)$ and $\bar{\alpha} \circ \eta_f^{\text{Norm}} = \alpha$, which proves the existence of a factorisation. Now for the uniqueness, suppose that $\beta, \gamma: \bar{A} \rightarrow C$ are such that

$$g \circ \beta = \text{Norm}(f) = g \circ \gamma \quad \text{and} \quad \beta \circ \eta_f^{\text{Norm}} = \alpha = \gamma \circ \eta_f^{\text{Norm}}.$$

We write π_1^f, π_2^f and π_1^g, π_2^g for the kernel pair projections of f and g , respectively. From the fact that g is a normal extension, we have $\text{Triv}(\pi_1^g) = \pi_1^g$ and $\underline{g} = \pi_2^g$. Since $g \circ \alpha \circ \text{Triv}(\pi_1^f) = f \circ \text{Triv}(\pi_1^f) = \text{Norm}(f) \circ \underline{f} = g \circ \beta \circ \underline{f}$ and, likewise, $g \circ \alpha \circ \text{Triv}(\pi_1^f) = g \circ \gamma \circ \underline{f}$, we find morphisms

$$\tilde{\beta} = \langle \alpha \circ \text{Triv}(\pi_1^f), \beta \circ \underline{f} \rangle, \tilde{\gamma} = \langle \alpha \circ \text{Triv}(\pi_1^f), \gamma \circ \underline{f} \rangle: \text{Eq}(f)_{\text{Triv}} \rightarrow \text{Eq}(g)$$

such that $\pi_2^g \circ \tilde{\beta} = \beta \circ \underline{f}$ and $\pi_2^g \circ \tilde{\gamma} = \gamma \circ \underline{f}$ while

$$\pi_1^g \circ \tilde{\beta} = \alpha \circ \text{Triv}(\pi_1^f) \quad \text{and} \quad \pi_1^g \circ \tilde{\gamma} = \alpha \circ \text{Triv}(\pi_1^f).$$

Now $\tilde{\beta} = \tilde{\gamma}$ follows from the uniqueness in the universal property of the trivial extension $\text{Triv}(\pi_1^f)$: indeed, $\tilde{\beta} \circ \eta_{\pi_1^f}^{\text{Triv}} = \alpha \times_{1_B} \alpha = \tilde{\gamma} \circ \eta_{\pi_1^f}^{\text{Triv}}$. Hence $\beta = \gamma$.

2.9 The result

Thus, keeping Proposition 5.8 in [21] in mind, we obtain:

Theorem 2.10. *Let $\Gamma = (\mathbf{C}, \mathbb{X}, I, H, \eta, \epsilon, \mathcal{E}, \mathcal{F})$ be an admissible Galois structure such that the conditions (G6) and (G7) hold. For any object B in \mathbf{C} , $\text{Norm}(B)$ is a reflective subcategory of $(\mathcal{E} \downarrow B)$. As a consequence, normal extensions are reflective amongst fibrations.* ■

2.11 A weaker condition

Condition (G7) is nice and simple, but it is slightly too strong to be applied to \mathcal{S} -protomodular categories as in Section 4. We may replace it by the following slightly weaker alternative, which is clearly still strong enough to imply the conclusion of Theorem 2.10:

(G7⁻) $\text{Norm}(\mathbf{C})$ is closed under coequalisers, in the category $\text{Arr}(\mathbf{C})$ of arrows in \mathbf{C} , of certain reflexive graphs in $\text{Fib}(\mathbf{C})$: given a reflexive graph of the following form

$$\begin{array}{ccccc} R & \rightleftarrows & A' & \xrightarrow{\delta} & A \\ f'' \downarrow & & \downarrow f' & & \downarrow f \\ \text{Eq}(h) & \rightleftarrows & B' & \xrightarrow{h} & B \end{array}$$

and its coequaliser, if f' and f'' are normal extensions, then also f is a normal extension.

We thus obtain

Theorem 2.12. *Let $\Gamma = (\mathbf{C}, \mathbb{X}, I, H, \eta, \epsilon, \mathcal{E}, \mathcal{F})$ be an admissible Galois structure such that the conditions (G6) and (G7⁻) hold. For any object B in \mathbf{C} , $\text{Norm}(B)$ is a reflective subcategory of $(\mathcal{E} \downarrow B)$. As a consequence, normal extensions are reflective amongst fibrations.* ■

3 \mathcal{S} -protomodular categories

Our criterion for the reflectiveness of normal extensions (Theorem 2.12) can be applied to a general algebraic situation, in which the category \mathbf{C} is an \mathcal{S} -protomodular category. The aim of this section is to recall the definition of an \mathcal{S} -protomodular category, as well as the results we need in order to show that this reflectiveness criterion is applicable.

The notion of \mathcal{S} -protomodular category was introduced for a pointed context in [11], and further developed in [12]. An extension to the non-pointed case was then considered in [8].

Let \mathbf{C} be a finitely complete category. We denote by $\text{Pt}(\mathbf{C})$ the **category of points** in \mathbf{C} , whose objects (f, s) are the split epimorphisms $f: A \rightarrow B$ with a chosen section $s: B \rightarrow A$ as in

$$A \begin{array}{c} \xleftarrow{s} \\ \xrightarrow{f} \end{array} B \qquad f \circ s = 1_B$$

and whose morphisms are pairs of morphisms which form commutative squares with both the split epimorphisms and their sections. Since split epimorphisms are stable under pullbacks, the functor $\text{cod}: \text{Pt}(\mathbf{C}) \rightarrow \mathbf{C}$, which associates with every split epimorphism its codomain, is a fibration, usually called the **fibration of points**. Let \mathcal{S} be a class of points in \mathbf{C} which is stable under pullbacks. If we look at it as a full subcategory $\text{SPt}(\mathbf{C})$ of $\text{Pt}(\mathbf{C})$, it gives rise to a subfibration \mathcal{S} -cod of the fibration of points. A point $(f: A \rightarrow B, s: B \rightarrow A)$ in a pointed category \mathbf{C} is said to be a **strong point** if the pair (k, s) , where k is a kernel of f , is jointly strongly epimorphic. Strong points were considered in [31], under the name of *regular points*, and independently in [7], under the name of *strongly split epimorphisms*.

Definition 3.1 ([11], Definition 8.1.1). Let \mathbf{C} be a pointed finitely complete category, and \mathcal{S} a pullback-stable class of points. We say that \mathbf{C} is **\mathcal{S} -protomodular** when:

- (1) every point in $\text{SPt}(\mathbf{C})$ is a strong point;
- (2) $\text{SPt}(\mathbf{C})$ is closed under finite limits in $\text{Pt}(\mathbf{C})$.

Remark 3.2. As mentioned in [8], in a pointed finitely complete category \mathbf{C} a point (f, s) is strong if and only if, for any pullback as in the diagram

$$\begin{array}{ccc} P & \xrightarrow{\pi_2} & A \\ \uparrow \lrcorner & & \uparrow \downarrow \\ \downarrow \pi_1 & & s \downarrow f \\ C & \xrightarrow{g} & B, \end{array}$$

the pair (π_2, s) is jointly strongly epimorphic. Thanks to this fact, the definition of \mathcal{S} -protomodular category can be extended to the non-pointed case, by simply replacing the notion of strong point by the property above (see [8, Definition 4.3]).

The name \mathcal{S} -protomodular comes from the fact that a pointed finitely complete category \mathbf{C} is protomodular if and only if every point in \mathbf{C} is a strong point [4]. Hence the notion above is a version of the concept of protomodular category, relative with respect to the class \mathcal{S} .

Example 3.3. As observed in [11], the categories \mathbf{Mon} of monoids and \mathbf{SRng} of semirings are \mathcal{S} -protomodular with respect to the class \mathcal{S} of Schreier split epimorphisms [30] (see below). Later, in [29], it was proved that every **Jónsson-Tarski variety**, which is a variety whose corresponding theory contains a unique constant 0 and a binary operation $+$ which satisfy the equations $0 + x = x + 0 = x$ for all x , is \mathcal{S} -protomodular with respect to the class of Schreier split epimorphisms. Let us now recall the definition of such split epimorphisms.

Definition 3.4 ([30, 29]). A split epimorphism $f: A \rightarrow B$ with given splitting $s: B \rightarrow A$ in a Jónsson-Tarski variety is a **Schreier split epimorphism** when, for every $a \in A$, there exists a unique α in the kernel N of f such that $a = \alpha + sf(a)$.

In Section 6 we give an example of an \mathcal{S} -protomodular category of a different nature.

Let \mathbf{C} be an \mathcal{S} -protomodular category. We recall from [12] that an \mathcal{S} -**reflexive graph** (or \mathcal{S} -**reflexive relation**)

$$Q \begin{array}{c} \xrightarrow{d} \\ \xleftarrow{e} \\ \xrightarrow{c} \end{array} A$$

is a reflexive graph (respectively, a reflexive relation) such that the point (d, e) belongs to \mathcal{S} . A morphism $f: A \rightarrow B$ is called an \mathcal{S} -**special morphism** when its kernel pair $\text{Eq}(f)$ is an \mathcal{S} -reflexive relation. An object X is called an \mathcal{S} -**special object** when the indiscrete relation on X is an \mathcal{S} -reflexive relation. This means that the point $(p_1: X \times X \rightarrow X, \langle 1_X, 1_X \rangle: X \rightarrow X \times X)$, where p_1 is the first projection, belongs to \mathcal{S} . The following result was proved, in the pointed case, in [12], and then extended with the same proof to the non-pointed case in [8].

Proposition 3.5 ([12], Proposition 6.2). *Let \mathbf{C} be an \mathcal{S} -protomodular category. Any split epimorphism between \mathcal{S} -special objects is in \mathcal{S} and, consequently, is an \mathcal{S} -special morphism. The full subcategory $\mathcal{S}\mathbf{C}$ of \mathcal{S} -special objects is protomodular. ■*

The protomodular subcategory $\mathcal{S}\mathbf{C}$ is called the **protomodular core** of \mathbf{C} relatively to the class \mathcal{S} . Observe that, since $\text{SPt}(\mathbf{C})$ is closed under finite limits in $\text{Pt}(\mathbf{C})$, the subcategory $\mathcal{S}\mathbf{C}$ is closed under finite limits in \mathbf{C} .

When \mathbf{C} is the category of monoids, and \mathcal{S} is the class of Schreier split epimorphisms, the protomodular core is the category of groups. Similarly, the protomodular core of the category of semirings is the category of rings.

4 An application to \mathcal{S} -protomodular categories

In this section we are going to consider a Galois structure Γ as in Definition 2.2, where \mathbf{C} is a finitely complete Barr-exact category with coequalisers of reflexive graphs, \mathbb{X} is a full reflective subcategory of \mathbf{C} , I is the reflector, H is the inclusion and \mathcal{E} and \mathcal{F} are the classes of regular epimorphisms. We assume that

1. \mathbb{X} is also Barr-exact;
2. H preserves regular epimorphisms, so that Γ is indeed a Galois structure;
3. Γ is admissible;
4. writing \mathcal{S} for the class of split epimorphic trivial extensions, the category \mathbb{C} is \mathcal{S} -protomodular.

The functor H being the inclusion functor, we omit it from writing to simplify notation. Note that, \mathcal{S} being the class of split epimorphic trivial extensions, \mathbb{X} is contained in the protomodular core $\mathcal{S}\mathbb{C}$ given by \mathcal{S} -special objects: if $X \in \mathbb{X}$, then the first projection $p_1: X \times X \rightarrow X$ is a trivial extension (because it is a morphism in \mathbb{X}). If \mathbb{C} is pointed, then \mathbb{X} is precisely the protomodular core $\mathcal{S}\mathbb{C}$. Indeed, if $p_1: X \times X \rightarrow X$ is a trivial extension, then it is the pullback of a morphism in \mathbb{X} . Hence its kernel, which is X , belongs to \mathbb{X} . In any case, \mathbb{X} is a full subcategory of the protomodular core $\mathcal{S}\mathbb{C}$, and being closed under finite limits in it (since it is closed under finite limits in \mathbb{C}), it is a protomodular category thanks to Proposition 3.5, thus a Mal'tsev category (Proposition 17 in [5]). Since \mathbb{X} is a Barr-exact Mal'tsev category, then any reflexive relation is necessary the kernel pair of its coequaliser.

Applying Theorem 2.12, we shall prove that in this setting, the normal extensions are reflective amongst the fibrations. Since condition (G6) is fulfilled by assumption, we only have to prove that condition (G7⁻) holds.

In a regular category, a commutative square of regular epimorphisms

$$\begin{array}{ccc} A' & \xrightarrow{g} & A \\ f' \downarrow & & \downarrow f \\ B' & \xrightarrow{h} & B \end{array}$$

is called a **regular pushout** [6] when the comparison morphism to the pullback $\langle f', g \rangle: A' \rightarrow B' \times_B A$ is a regular epimorphism.

Lemma 4.1. *In a regular category, pulling back along a morphism of regular epimorphisms preserves regular pushout squares.*

Proof. A square of regular epimorphisms as above is a regular pushout if and only if it decomposes as a composite of two squares of regular epimorphisms

$$\begin{array}{ccccc} A' & \longrightarrow & B' \times_B A & \longrightarrow & A \\ \downarrow & & \downarrow & \lrcorner & \downarrow \\ B' & \xlongequal{\quad} & B' & \xrightarrow{h} & B, \end{array}$$

where the square on the right is a pullback. Given a regular epimorphism $r: C' \rightarrow C$ and a morphism $(f', f): r \rightarrow h$, pulling back the given regular pushout square along it yields a regular pushout square over r . ■

Lemma 4.2. *Any commutative solid diagram*

$$\begin{array}{ccc}
 \text{Eq}(f) & \xrightarrow{\bar{h}} & \text{Eq}(g) \\
 \begin{array}{c} \uparrow \text{dotted} \\ f_1 \downarrow \\ \uparrow \text{dotted} \\ f_2 \downarrow \end{array} & & \begin{array}{c} \uparrow \text{dotted} \\ g_1 \downarrow \\ \uparrow \text{dotted} \\ g_2 \downarrow \end{array} \\
 A & \xrightarrow{h} & C \\
 \begin{array}{c} \downarrow f \\ \downarrow g \end{array} & & \begin{array}{c} \downarrow g \\ \downarrow k \end{array} \\
 B & \xrightarrow{k} & D,
 \end{array}$$

where the bottom square $gh = kf$ is a pushout of regular epimorphisms and f is a trivial extension is a regular pushout. Consequently, the comparison morphism \bar{h} is also a regular epimorphism.

Proof. By Proposition 5.4 and Theorem 5.5 in [14] it suffices to prove that $\text{Eq}(h)$ and $\text{Eq}(f)$ permute to show that the bottom square is a regular pushout. The equality $\text{Eq}(h)\text{Eq}(f) = \text{Eq}(f)\text{Eq}(h)$ can be proved with an argument which is completely analogous to the one used in the proof of Theorem 3.9 in [9]. ■

We recall that kernel pairs in $\text{Pt}(\mathbf{C})$ are computed objectwise: if (g, h) is a morphism of points, then $\text{Eq}((g, h)) = (\text{Eq}(g), \text{Eq}(h))$. Moreover, when \mathbf{C} is regular, a morphism (g, h) in $\text{Pt}(\mathbf{C})$ is a regular epimorphism if and only if both g and h are regular epimorphisms in \mathbf{C} .

Lemma 4.3. *The functor $\text{Triv}|_{\text{Pt}(\mathbf{C})} : \text{Pt}(\mathbf{C}) \rightarrow \text{Pt}(\mathbf{C})$ preserves coequalisers of (effective) equivalence relations.*

Proof. Consider the coequaliser diagram

$$\begin{array}{ccccc}
 \text{Eq}(g) & \begin{array}{c} \xrightarrow{g_1} \\ \xleftarrow{g_2} \end{array} & A' & \xrightarrow{g} & A \\
 \begin{array}{c} \uparrow \text{dotted} \\ s'' \downarrow \\ \uparrow \text{dotted} \\ f'' \downarrow \end{array} & & \begin{array}{c} \uparrow \text{dotted} \\ s' \downarrow \\ \uparrow \text{dotted} \\ f' \downarrow \end{array} & & \begin{array}{c} \uparrow \text{dotted} \\ s \downarrow \\ \uparrow \text{dotted} \\ f \downarrow \end{array} \\
 \text{Eq}(h) & \begin{array}{c} \xrightarrow{h_1} \\ \xleftarrow{h_2} \end{array} & B' & \xrightarrow{h} & B
 \end{array}$$

in $\text{Pt}(\mathbf{C})$. Since I preserves all coequalisers, we obtain a reflexive graph in $\text{Pt}(\mathbb{X})$ with its coequaliser

$$\begin{array}{ccccc}
 I(\text{Eq}(g)) & \begin{array}{c} \xrightarrow{I(g_1)} \\ \xleftarrow{I(g_2)} \end{array} & I(A') & \xrightarrow{I(g)} & I(A) \\
 \begin{array}{c} \uparrow \text{dotted} \\ \downarrow \end{array} & & \begin{array}{c} \uparrow \text{dotted} \\ \downarrow \end{array} & & \begin{array}{c} \uparrow \text{dotted} \\ \downarrow \end{array} \\
 I(\text{Eq}(h)) & \begin{array}{c} \xrightarrow{I(h_1)} \\ \xleftarrow{I(h_2)} \end{array} & I(B') & \xrightarrow{I(h)} & I(B).
 \end{array}$$

The inclusion $\mathbb{X} \rightarrow \mathbf{C}$ preserves regular epimorphisms (by assumption) and kernel pairs, so this diagram is still a reflexive graph with its coequaliser when considered in the category $\text{Pt}(\mathbf{C})$. Indeed, if we take the (regular epimorphism,

monomorphism) factorisation of $\langle I(g_1), I(g_2) \rangle: I(\text{Eq}(g)) \rightarrow I(A') \times I(A')$ in \mathbb{X} , we get a reflexive relation, say $\langle e_1, e_2 \rangle: E \rightarrow I(A') \times I(A')$, and the coequaliser of (e_1, e_2) is still $I(g)$. Since \mathbb{X} is a Barr-exact Mal'tsev category, E is necessarily the kernel pair of its coequaliser $I(g)$, as mentioned above. Thus, the comparison $I(\text{Eq}(g)) \rightarrow \text{Eq}(I(g))$ is a regular epimorphism, and similarly for $I(\text{Eq}(h)) \rightarrow \text{Eq}(I(h))$.

Now we pull back along $\eta_B, \eta_{B'}, \langle I(h_1), I(h_2) \rangle \circ \eta_{\text{Eq}(h)}$ and $\eta_{\text{Eq}(h)}$ to obtain the diagram

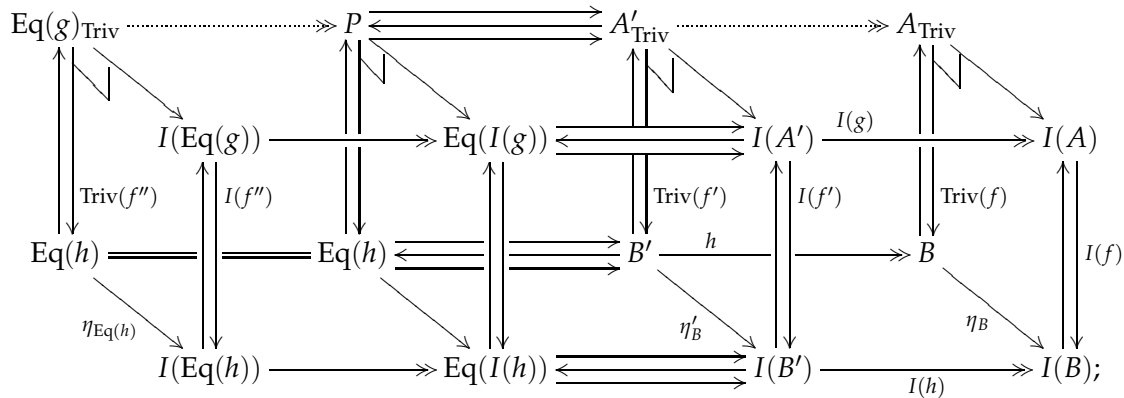

we write $P = \text{Eq}(h) \times_{\text{Eq}(I(h))} \text{Eq}(I(g))$ to simplify notation. Since the front left and right faces are regular pushouts (Proposition 3.2 in [6]), the dotted arrows are regular epimorphisms by Lemma 4.1. Moreover, pullbacks preserve kernel pairs, so that P must be the kernel pair of the regular epimorphism $A'_{\text{Triv}} \rightarrow A_{\text{Triv}}$. Consequently, $\text{Triv}(f)$, being the coequaliser of its kernel pair, is also the coequaliser of the reflexive graph $\text{Triv}(f'') \rightrightarrows \text{Triv}(f')$. ■

Proposition 4.4. Consider a reflexive graph and its coequaliser in $\text{Pt}(\mathbb{C})$

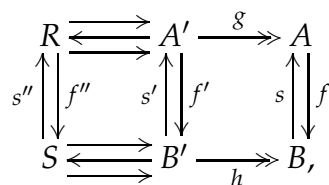

where f'' and f' are split epimorphic trivial extensions. Then f is also a split epimorphic trivial extension.

Proof. We first consider the situation where $R = \text{Eq}(g)$ and $S = \text{Eq}(h)$ are the kernel pairs of g and h , respectively. By assumption, f is the coequaliser of its kernel pair

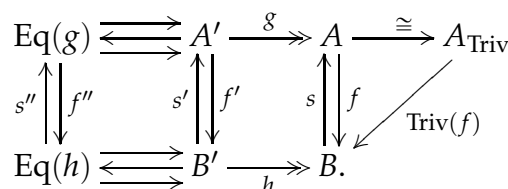

But, applying Lemma 4.3, we conclude that $\text{Triv}(f)$ is also its coequaliser, since $\text{Triv}(f') = f'$ and $\text{Triv}(f'') = f''$. Thus $\text{Triv}(f)$ and f are isomorphic, which proves that f is a trivial extension.

Now we prove that the above assumption can be made without any loss of generality. Consider the diagram

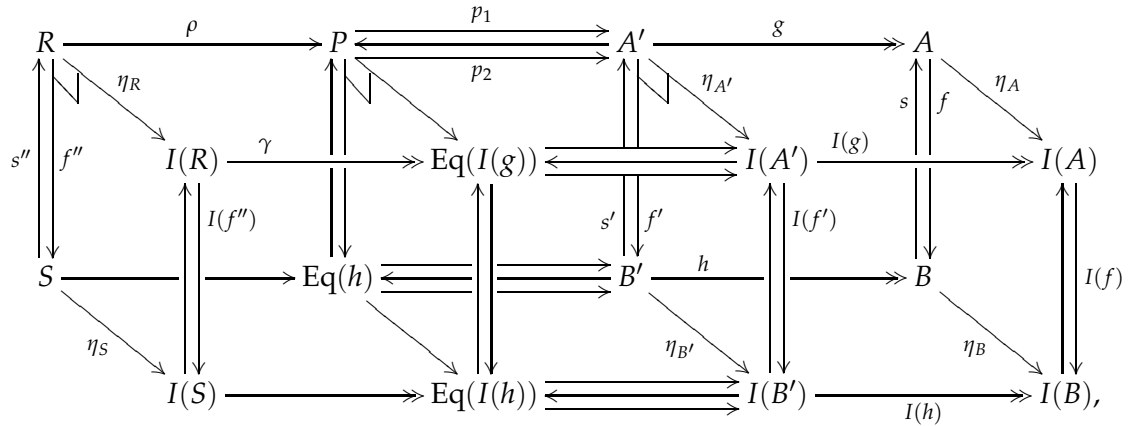

where $P = \text{Eq}(h) \times_{\text{Eq}(I(h))} \text{Eq}(I(g))$. We shall prove that P is precisely the kernel pair of g , so that the induced split epimorphism $\text{Eq}(g) \rightarrow \text{Eq}(h)$ is a trivial extension, being a pullback of a fibration in \mathbb{X} (Proposition 2.5).

For P to be the kernel pair of g , we just need to show that $g \circ p_1 = g \circ p_2$, since the rest of the proof is straightforward. As in the previous proof, the comparison morphisms $I(R) \rightarrow \text{Eq}(I(g))$ and $I(S) \rightarrow \text{Eq}(I(h))$ are regular epimorphisms, so that the front left square of the diagram above is a regular pushout (Proposition 3.2 in [6]). Consequently, the comparison morphism

$$\langle I(f''), \gamma \rangle: I(R) \rightarrow I(S) \times_{\text{Eq}(I(h))} \text{Eq}(I(g))$$

is a regular epimorphism and so is the comparison morphism $\langle f'', \rho \rangle$ in

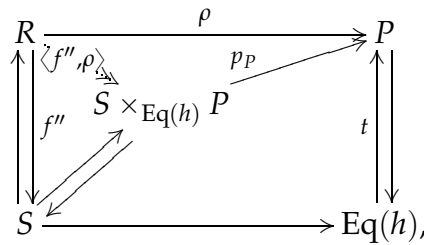

as a pullback of $\langle I(f''), \gamma \rangle$. The split epimorphism $\text{Eq}(I(g)) \rightrightarrows \text{Eq}(I(h))$ belongs to \mathcal{S} by Proposition 3.5, and so does the split epimorphism $P \rightrightarrows \text{Eq}(h)$ by the assumption of stability under pullbacks. Since \mathbf{C} is an \mathcal{S} -protomodular category, the pair (p_P, t) is jointly strongly epimorphic, thus jointly epimorphic (Remark 3.2). Then, the pair (ρ, t) is jointly epimorphic, so we get $g \circ p_1 = g \circ p_2$. This finishes the proof. ■

We have the following partial converse of Proposition 4.4.

Proposition 4.5. Consider a morphism of points and its kernel pair in $\text{Pt}(\mathbf{C})$

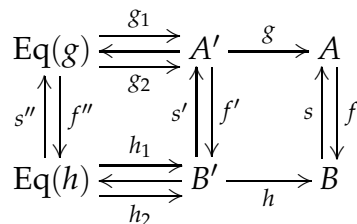

where f and f' are split epimorphic trivial extensions. Then f'' is also a split epimorphic trivial extension.

Proof. This follows from the finite limit closure in the definition of \mathcal{S} -protomodularity (Definition 3.1). ■

Since the class \mathcal{S} we are considering is the class of split epimorphic trivial extensions, then the \mathcal{S} -special regular epimorphisms are precisely the normal extensions with respect to the Galois structure Γ (Definition 2.3). We are now ready to prove that condition $(G7^-)$ holds.

Proposition 4.6. *The category of \mathcal{S} -special regular epimorphisms is closed in $\text{Arr}(\mathbf{C})$ under coequalisers of reflexive graphs, when they are of the type considered in condition $(G7^-)$.*

Proof. Consider a reflexive graph of regular epimorphisms and its coequaliser in \mathbf{C} as in the solid part of the diagram in Figure 2. Assume that S is an equivalence relation, so that $S = \text{Eq}(h)$. We prove that, if f'' and f' are \mathcal{S} -special regular epimorphisms, then also f is an \mathcal{S} -special regular epimorphism.

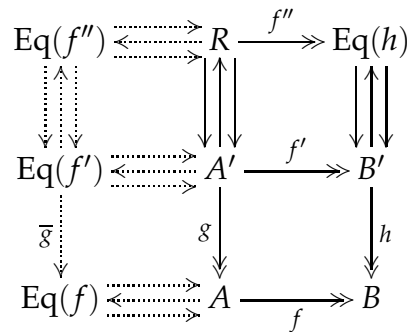
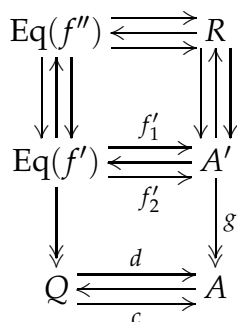

Figure 2: Closedness of \mathcal{S} -special regular epimorphisms under coequalisers of certain reflexive graphs

Taking kernel pairs to the left, we want to use Proposition 4.4 together with the fact that \mathcal{S} -special regular epimorphisms are precisely normal extensions to show that the kernel pair projections of f are trivial extensions. For this argument to be valid, we need to show that: (1) \bar{g} is a regular epimorphism; and (2) it is the coequaliser of the pair of vertical arrows $\text{Eq}(f'') \rightrightarrows \text{Eq}(f')$.

We may deduce (1) that \bar{g} is a regular epimorphism from the fact that the coequaliser of $\text{Eq}(f'') \rightrightarrows \text{Eq}(f')$



is an internal groupoid on A . Indeed, by Proposition 4.4, it is an \mathcal{S} -reflexive graph since d is a split epimorphic trivial extension. Thanks to Proposition 7.5 in [12] (and to its extension to the non-pointed context, see Proposition 4.9 in [8]), it suffices then to show that the kernel pairs $\text{Eq}(d)$ and $\text{Eq}(c)$ centralise each other. The kernel pairs $\text{Eq}(f'_1)$ and $\text{Eq}(f'_2)$ centralise each other, since $\text{Eq}(f')$ is an equivalence relation. By Lemma 4.2, $\text{Eq}(d)$ (resp. $\text{Eq}(c)$) is the regular image of $\text{Eq}(f'_1)$ (resp. $\text{Eq}(f'_2)$), so that $\text{Eq}(d)$ and $\text{Eq}(c)$ centralise each other too (Proposition 1.6.4 in [2]). Hence the regular image of this internal groupoid is an equivalence relation, so a kernel pair, with coequalizer f , which makes it isomorphic to $\text{Eq}(f)$.

Observe that, in the proof of (1), we do not need S to be an equivalence relation.

For the proof of (2), write $f''' : \text{Eq}(g) \rightarrow \text{Eq}(h)$ for the kernel pair of (g, h) . Taking kernel pairs to the left, we obtain the kernel pair projections $\text{Eq}(f''') \rightrightarrows \text{Eq}(g)$. Note that $\text{Eq}(f''')$ is actually the kernel pair of \bar{g} by interchange of limits. We claim that the comparison $R \rightarrow \text{Eq}(g)$ is a regular epimorphism. Hence, by pullback, so is the comparison $\text{Eq}(f'') \rightarrow \text{Eq}(f''')$, which finishes the proof of (2).

We are left with proving our claim that $R \rightarrow \text{Eq}(g)$ is a regular epimorphism. We do so by showing that there is a quotient R' of R which is a groupoid, so that the “image” of the reflexive graph R is an (effective) equivalence relation (namely $\text{Eq}(g)$). The groupoid R' is obtained as a pullback of groupoids like in the diagram

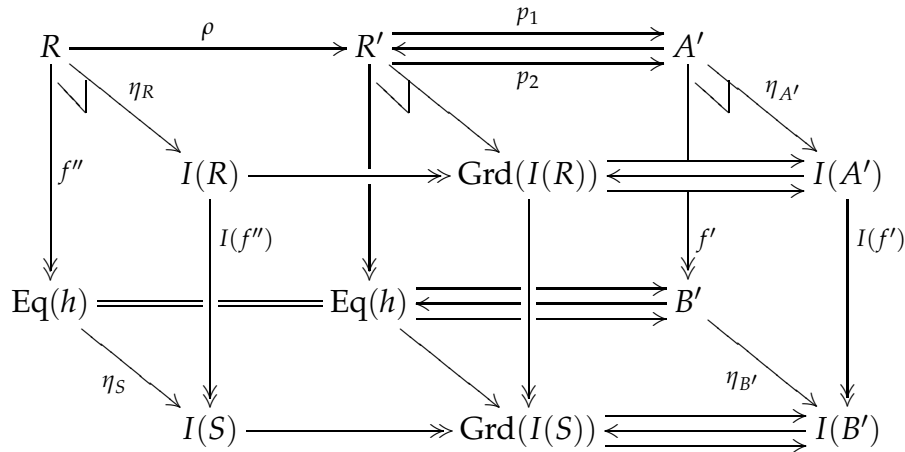

where $\text{Grd}(I(R))$ and $\text{Grd}(I(S))$ are the groupoids associated with the reflexive graphs $I(R)$ and $I(S)$, respectively. Since \mathbb{X} is a Barr-exact Mal'tsev category, the reflection of reflexive graphs to groupoids is Birkhoff (Corollary 3.15 in [34] combined with Theorem 3.1 in [18]), so that (keeping Theorem 5.7 in [14] in mind) the front left square is a regular pushout. The morphism ρ is now a regular epimorphism by Lemma 4.1. ■

Corollary 4.7. *The category of \mathcal{S} -special regular epimorphisms in \mathbb{C} is closed in $\text{Arr}(\mathbb{C})$ under coequalisers of equivalence relations.* ■

Theorem 2.12 now implies the main result of this section.

Theorem 4.8. *\mathcal{S} -special regular epimorphisms are reflective amongst regular epimorphisms.* ■

We conclude this section by observing that the criterion for reflectiveness of normal extensions given by Theorem 4.2 in [25] cannot be applied to obtain the theorem above in our general framework, since we are not supposing that the category \mathbf{C} admits the colimits that are needed to apply that theorem.

5 Examples

In this section we describe some concrete examples of the general framework developed in the previous one.

5.1 Monoids and groups

The first example we consider is the following: $\mathbf{C} = \mathbf{Mon}$ is the category of monoids, and $\mathbb{X} = \mathbf{Gp}$ is the subcategory of groups. The reflection $\mathbf{Gp}: \mathbf{Mon} \rightarrow \mathbf{Gp}$ is given by the **Grothendieck group** (or **group completion**) [26, 27, 28]: given a monoid $(M, \cdot, 1)$, its group completion $\mathbf{Gp}(M)$ is defined by

$$\mathbf{Gp}(M) = \frac{\mathbf{GpF}(M)}{\mathbf{N}(M)},$$

where $\mathbf{GpF}(M)$ denotes the free group on M and $\mathbf{N}(M)$ is the normal subgroup generated by elements of the form $[m_1][m_2][m_1 \cdot m_2]^{-1}$. By choosing the classes of morphisms \mathcal{E} and \mathcal{F} to be the surjections in \mathbf{Mon} and \mathbf{Gp} , respectively, we obtain a Galois structure

$$\Gamma_{\mathbf{Mon}} = (\mathbf{Mon}, \mathbf{Gp}, \mathbf{Gp}, \mathbf{Mon}, \eta, \epsilon, \mathcal{E}, \mathcal{F}),$$

where \mathbf{Mon} is just the inclusion functor from \mathbf{Gp} to \mathbf{Mon} . This Galois structure was studied in [32], where it was shown to be admissible (Theorem 2.2 there). Moreover, trivial, normal and central extensions were characterised for this Galois structure. Let us briefly recall what they are.

Definition 5.2 ([11], Definition 2.1.1). Let f be a split epimorphism of monoids, with a chosen splitting \mathcal{S} , and N its (canonical) kernel

$$N \begin{array}{c} \dashrightarrow \\ \xrightarrow{k} \end{array} A \begin{array}{c} \xleftarrow{s} \\ \xrightarrow{f} \end{array} B.$$

The split epimorphism (f, s) is said to be **right homogeneous** when, for every element $b \in B$, the function $\mu_b: N \rightarrow f^{-1}(b)$ defined through multiplication on the right by $s(b)$, so $\mu_b(n) = ns(b)$, is bijective. Similarly, we can define a **left homogeneous** split epimorphism: the function $N \rightarrow f^{-1}(b): n \mapsto s(b)n$ is a bijection for all $b \in B$. A split epimorphism is said to be **homogeneous** when it is both right and left homogeneous.

As observed in [11], Proposition 2.1.3, a split epimorphism is right homogeneous if and only if it is a Schreier split epimorphism (Definition 3.4).

Definition 5.3 ([11], Definition 7.1.1). Given a surjective homomorphism g of monoids and its kernel pair

$$\text{Eq}(g) \begin{array}{c} \xrightarrow{\pi_1} \\ \xleftarrow{\Delta} \\ \xrightarrow{\pi_2} \end{array} A \xrightarrow{g} B,$$

the morphism g is called a **special homogeneous surjection** when (π_1, Δ) (or, equivalently, (π_2, Δ)) is a homogeneous split epimorphism.

Proposition 5.4 ([32], Proposition 4.2). *For a split epimorphism f of monoids, the following statements are equivalent:*

- (i) f is a trivial extension;
- (ii) f is a special homogeneous surjection. ■

Theorem 5.5 ([32], Theorem 4.4). *For a surjective homomorphism g of monoids, the following statements are equivalent:*

- (i) g is a central extension;
- (ii) g is a normal extension;
- (iii) g is a special homogeneous surjection. ■

Special homogeneous split epimorphisms are, in particular, Schreier split epimorphisms, hence strong points ([11], Lemma 2.1.6). Moreover, they are stable under pullbacks ([11], Proposition 7.1.4). So, Mon is an \mathcal{S} -protomodular category with respect to the class \mathcal{S} of special homogeneous split epimorphisms, which are precisely the split epimorphic trivial extensions of the Galois structure Γ_{Mon} we are considering. All the other conditions we assumed in Section 4 are clearly satisfied by Γ_{Mon} . As a consequence of Theorem 4.8, we see that special homogeneous surjections are reflective amongst surjective monoid homomorphisms. We observe that this fact was already proved in [33], using Theorem 4.2 in [25] (although, as we already mentioned, the same theorem cannot be applied to the general framework of Section 4).

5.6 Semirings and rings

The second example we consider is of a similar nature. Now $\mathbb{C} = \text{SRng}$ is the category of semirings, and $\mathbb{X} = \text{Rng}$ is the reflective subcategory of rings. In order to describe the reflection, we first restrict the group completion functor to commutative monoids. This restriction has a simpler description which we now recall. If $(M, +, 0)$ is a commutative monoid, then its group completion $\text{Gp}(M)$ can be described as the quotient $M \times M / \sim$, where $(m, n) \sim (p, q)$ when there exists $k \in m$ such that

$$m + q + k = n + p + k.$$

Now let $(M, +, \cdot, 0)$ be a semiring; we can define a product in $\text{Gp}(M)$ in the following way:

$$[(m, n)] \cdot [(m', n')] = [(m \cdot m' + n \cdot n', m \cdot n' + n \cdot m')].$$

It is easy to check that this definition does not depend on the choice of the representative for the class in $\text{Gp}(M)$, and that it turns $\text{Gp}(M)$ into a ring. Hence it gives the desired reflection $\text{SRng} \rightarrow \text{Rng}$.

Via a simplified version of the arguments used in [32] for the Galois structure between Mon and Gp , it is not difficult to see that the reflection of the adjunction between SRng and Rng is admissible with respect to the classes of surjective homomorphisms both in SRng and in Rng . Hence we get an admissible Galois structure. Once again, the split epimorphic trivial extensions are precisely the special homogeneous split epimorphisms, while the normal (= central) extensions are the special homogeneous surjections; the proofs easily follow from those of Proposition 5.4 and Theorem 5.5. Proposition 6.7.2 in [11] implies that a split epimorphism $(f: A \rightarrow B, s: B \rightarrow A)$ in SRng is special homogeneous if and only if the kernel N of f is a ring and A is isomorphic to a semidirect product of B and N . (Observe that every Schreier split epimorphism of semirings is homogeneous, because the additive monoid structure is commutative.) This implies, in particular, that A , as a monoid, is the cartesian product of B and N .

It is easy to see that all the conditions of Section 4 are satisfied by this Galois structure. Hence Theorem 4.8 implies, like for the case of monoids and groups, that special homogeneous surjections of semirings are reflective amongst surjective homomorphisms. (Once again, we could also conclude this by applying Theorem 4.2 in [25].)

6 The additive core of a unital category

This section is devoted to the description of a general example of the situation considered in Section 4. This example is of a rather different nature from the ones of the previous section, so that Theorem 4.2 of [25] does not apply.

We start by recalling from [5] that a pointed finitely complete category \mathbf{C} is **unital** when, for every pair of objects (A, B) of \mathbf{C} , the morphisms $\langle 1_A, 0_{A,B} \rangle$ and $\langle 0_{B,A}, 1_B \rangle$ in the product diagram

$$A \begin{array}{c} \xleftarrow{p_A} \\ \xrightarrow{\langle 1_A, 0_{A,B} \rangle} \end{array} A \times B \begin{array}{c} \xleftarrow{p_B} \\ \xrightarrow{\langle 0_{B,A}, 1_B \rangle} \end{array} B$$

are jointly strongly epimorphic.

Examples of unital categories are all Jónsson-Tarski varieties (Example 3.3). Actually, as shown in [2, Theorem 1.2.15], a variety of universal algebras is a unital category precisely when it is a Jónsson-Tarski variety.

An object X in a unital category \mathbf{C} is called **abelian** when it carries an internal abelian group structure (which is necessarily unique, as a consequence of Theorem 1.4.5 in [2]). The full subcategory of \mathbf{C} determined by the abelian objects is denoted $\text{Ab}(\mathbf{C})$ and called the **additive core** of \mathbf{C} . The category $\text{Ab}(\mathbf{C})$ is indeed additive (by Corollary 1.10.13 in [2]), hence it is protomodular (by Example 3.1.13 in [2]). If \mathbf{C} is a finitely cocomplete regular unital category, then $\text{Ab}(\mathbf{C})$ is really a core, since it is a reflective subcategory of \mathbf{C} by Propositions 1.7.5 and 1.7.6 of [2]

$$\mathbf{C} \begin{array}{c} \xrightarrow{\text{Ab}} \\ \xleftarrow{\perp} \\ \xrightarrow{\cong} \end{array} \text{Ab}(\mathbf{C});$$

the unit is denoted by η^{Ab} . Since $\text{Ab}(\mathbf{C})$ is closed in \mathbf{C} under regular epimorphisms [2, Proposition 1.6.11], this adjunction gives a Galois structure with respect to the regular epimorphisms in \mathbf{C} and in $\text{Ab}(\mathbf{C})$; we denote it by Γ_{Ab} .

We now assume \mathbf{C} to be a finitely cocomplete Barr-exact unital category. We can then show that the Galois structure Γ_{Ab} satisfies all the conditions of Section 4. First of all, $\text{Ab}(\mathbf{C})$ is also Barr-exact [1, Theorem 5.11]. The additive core $\text{Ab}(\mathbf{C})$ is then an abelian category, called the **abelian core** of \mathbf{C} . Next, we shall prove that \mathbf{C} is an \mathcal{S} -protomodular category, where \mathcal{S} is the class of split epimorphic trivial extensions. In fact, the split epimorphic trivial extensions for the Galois structure Γ_{Ab} have an easy description: see Proposition 6.2.

Lemma 6.1. *If B is an object and N an abelian object of \mathbf{C} then*

$$\text{Ab}(N \times B) \cong N \times \text{Ab}(B).$$

Proof. There is a comparison morphism

$$\lambda: \text{Ab}(N \times B) \rightarrow N \times \text{Ab}(B)$$

such that $\lambda \circ \eta_{N \times B}^{\text{Ab}} = 1_N \times \eta_B^{\text{Ab}}$. We use the fact that binary products coincide with binary coproducts in $\text{Ab}(\mathbf{C})$ and consider the morphism

$$\zeta = \left(\eta_{N \times B}^{\text{Ab}} \circ \langle 1_N, 0_{N,B} \rangle \quad \text{Ab}(\langle 0_{B,N}, 1_B \rangle) \right) : N \oplus \text{Ab}(B) \rightarrow \text{Ab}(N \times B).$$

Note that for the coproduct inclusions i_N and $i_{\text{Ab}(B)}$ of $N \oplus \text{Ab}(B)$, we have $i_N = \langle 1_N, 0_{N, \text{Ab}(B)} \rangle$ and $i_{\text{Ab}(B)} = \langle 0_{\text{Ab}(B), N}, 1_{\text{Ab}(B)} \rangle$. Then

$$\lambda \circ \zeta \circ i_N = \lambda \circ \eta_{N \times B}^{\text{Ab}} \circ \langle 1_N, 0_{N,B} \rangle = (1_N \times \eta_B^{\text{Ab}}) \circ \langle 1_N, 0_{N,B} \rangle = \langle 1_N, 0_{N, \text{Ab}(B)} \rangle = i_N$$

and

$$\begin{aligned} \lambda \circ \zeta \circ i_{\text{Ab}(B)} \circ \eta_B^{\text{Ab}} &= \lambda \circ \text{Ab}(\langle 0_{B,N}, 1_B \rangle) \circ \eta_B^{\text{Ab}} = \lambda \circ \eta_{N \times B}^{\text{Ab}} \circ \langle 0_{B,N}, 1_B \rangle \\ &= (1_N \times \eta_B^{\text{Ab}}) \circ \langle 0_{B,N}, 1_B \rangle = \langle 0_{B,N}, \eta_B^{\text{Ab}} \rangle \\ &= \langle 0_{\text{Ab}(B), N}, 1_{\text{Ab}(B)} \rangle \circ \eta_B^{\text{Ab}} = i_{\text{Ab}(B)} \circ \eta_B^{\text{Ab}}. \end{aligned}$$

The universal property of the unit η^{Ab} gives $\lambda \circ \zeta \circ i_{\text{Ab}(B)} = i_{\text{Ab}(B)}$, so that $\lambda \circ \zeta = 1_{N \oplus \text{Ab}(B)}$.

On the other hand, the equalities

$$\zeta \circ (1_N \times \eta_B^{\text{Ab}}) \circ \langle 1_N, 0_{N,B} \rangle = \zeta \circ \langle 1_N, 0_{N, \text{Ab}(B)} \rangle = \zeta \circ i_N = \eta_{N \times B}^{\text{Ab}} \circ \langle 1_N, 0_{N,B} \rangle$$

and

$$\begin{aligned} \zeta \circ (1_N \times \eta_B^{\text{Ab}}) \circ \langle 0_{B,N}, 1_B \rangle &= \zeta \circ \langle 0_{B,N}, \eta_B^{\text{Ab}} \rangle = \zeta \circ \langle 0_{\text{Ab}(B), N}, 1_{\text{Ab}(B)} \rangle \circ \eta_B^{\text{Ab}} \\ &= \zeta \circ i_{\text{Ab}(B)} \circ \eta_B^{\text{Ab}} = \text{Ab}(\langle 0_{B,N}, 1_{\text{Ab}(B)} \rangle) \circ \eta_B^{\text{Ab}} \\ &= \eta_{N \times B}^{\text{Ab}} \circ \langle 0_{B,N}, 1_B \rangle \end{aligned}$$

show that $\zeta \circ (1_N \times \eta_B^{\text{Ab}}) = \eta_{N \times B}^{\text{Ab}}$ since $\langle 1_N, 0_{N,B} \rangle$ and $\langle 0_{B,N}, 1_B \rangle$ are jointly epimorphic, \mathbf{C} being a unital category. Finally, from

$$\zeta \circ \lambda \circ \eta_{N \times B}^{\text{Ab}} = \zeta \circ (1_N \times \eta_B^{\text{Ab}}) = \eta_{N \times B}^{\text{Ab}}$$

we conclude that $\zeta \circ \lambda = 1_{\text{Ab}(N \times B)}$ by the universal property of the unit η^{Ab} . ■

Proposition 6.2. *Let \mathbf{C} be a finitely cocomplete Barr-exact unital category. A split epimorphism $f: A \rightarrow B$ with splitting $s: B \rightarrow A$ in \mathbf{C} is a trivial extension with respect to Γ_{Ab} if and only if the following two conditions hold:*

1. (f, s) is isomorphic, as a point, to a product

$$(p_B: N \times B \rightarrow B, \langle 0_{B,N}, 1_B \rangle: B \rightarrow N \times B);$$

2. the kernel N of f is abelian.

Proof. Let (f, s) be a split epimorphic trivial extension. Then the square

$$\begin{array}{ccc} A & \xrightarrow{\eta_A^{\text{Ab}}} & \text{Ab}(A) \\ \downarrow f & \lrcorner & \uparrow \text{Ab}(f) \\ B & \xrightarrow{\eta_B^{\text{Ab}}} & \text{Ab}(B) \end{array}$$

is a pullback. So the kernel N of f is also the kernel of $\text{Ab}(f)$, and is therefore abelian. Moreover, a split epimorphism in $\text{Ab}(\mathbf{C})$ is a product projection and, consequently, (f, s) is isomorphic to $(p_B, \langle 0_{B,N}, 1_B \rangle)$.

Conversely, we must show that any product projection $(p_B, \langle 0, 1_B \rangle)$, where N is abelian, is a trivial extension. To do so it suffices to show that

$$\text{Ab}(N \times B) \cong N \times \text{Ab}(B),$$

so that $\eta_{N \times B} \cong 1_N \times \eta_B$. This is precisely Lemma 6.1. ■

Thanks to this characterisation, we have that \mathbf{C} is \mathcal{S} -protomodular with respect to the class of split epimorphic trivial extensions. This follows easily from the fact that a pointed finitely complete category \mathbf{C} is unital if and only if it is \mathcal{S} -protomodular with respect to the class \mathcal{S} of points of the form $(p_B, \langle 0_{B,N}, 1_B \rangle)$ —an observation which is due to Sandra Mantovani.

The last condition of Section 4 we must show to hold concerns the admissibility of the Galois structure Γ_{Ab} . The last condition of Section 4 we must show to hold concerns the admissibility of the Galois structure Γ_{Ab} . This was first proved, for Mal'tsev categories, in [24], and then extended in [19] to *factor permutable categories*. However, the case of unital categories was never considered. We observe that our main example, namely the category of monoids, is not factor permutable. The idea of the proof of the following result is similar to the one of Theorem 5.2 in [19].

Theorem 6.3. *Let \mathbf{C} be a finitely cocomplete Barr-exact unital category. The Galois structure Γ_{Ab} is admissible.*

Proof. Combining Theorem 4.3 in [15] with both Definition 5.5.3 and Proposition 5.5.5 in [3], we see that the Galois structure Γ_{Ab} is admissible if and only if every pullback

$$\begin{array}{ccc} X & \xrightarrow{a} & A \\ \downarrow f & \lrcorner & \downarrow g \\ Y & \xrightarrow{b} & B \end{array}$$

with g a regular epimorphism in $\text{Ab}(\mathbb{C})$ is preserved by the reflector Ab .

We first begin by supposing that g is a split epimorphism, hence a product projection. Then, being its pullback, so is the split epimorphism f . Furthermore, the morphism a in the pullback is of the form $1_{N \times B}: N \times Y \rightarrow N \times B$ with N abelian, and it follows from Lemma 6.1 that Ab preserves such a pullback.

For the general case, we consider the diagram

$$\begin{array}{ccccc}
 \text{Eq}(f) & \xrightarrow{\eta_{\text{Eq}(f)}^{\text{Ab}}} & \text{Ab}(\text{Eq}(f)) & \longrightarrow & \text{Eq}(g) \\
 \Downarrow & & \Downarrow & & \Downarrow \\
 X & \xrightarrow{\eta_X^{\text{Ab}}} & \text{Ab}(X) & \longrightarrow & A \\
 f \downarrow & & \downarrow \text{Ab}(f) & & \downarrow g \\
 Y & \xrightarrow{\eta_Y^{\text{Ab}}} & \text{Ab}(Y) & \longrightarrow & B.
 \end{array}$$

The top rectangle fits into the previous case, so we can conclude that both top squares are pullbacks. As mentioned in Section 4, the comparison morphism $\text{Ab}(\text{Eq}(f)) \rightarrow \text{Eq}(\text{Ab}(f))$ is a regular epimorphism. Since the top right square above is a discrete fibration, this comparison morphism is also a (split) monomorphism, thus an isomorphism. By applying a well-known result for regular categories—called the “Barr-Kock Theorem” in [10]; see Theorem 2.17 there, or 6.10 in [1]—to the right hand side diagram, we conclude that the bottom right square is a pullback. ■

We may conclude that all the conditions of Section 4 are satisfied. Hence Theorem 4.8 gives the following

Theorem 6.4. *Let \mathbb{C} be a finitely cocomplete Barr-exact unital category, and $\text{Ab}(\mathbb{C})$ its abelian core. Then normal extensions with respect to the induced Galois structure Γ_{Ab} are reflective amongst regular epimorphisms.* ■

6.5 Monoids versus abelian groups

We describe the normal extensions with respect to Γ_{Ab} in the particular case when \mathbb{C} is the category of monoids, so that $\text{Ab}(\mathbb{C})$ is the category of abelian groups. Our description is similar to that of Theorem 5.5 concerning the Galois structure Γ_{Mon} of Section 5. However, now we must add a commutativity condition. So, we need to recall the following.

Definition 6.6 ([20]). Two subobjects $x: X \rightarrow Z$ and $y: Y \rightarrow Z$ of Z in a finitely complete unital category \mathbb{C} are said to **commute** if there exists a (necessarily unique) morphism $\varphi: X \times Y \rightarrow Z$, called the **cooperator** of x and y , such that both triangles in the diagram

$$\begin{array}{ccc}
 X & \xrightarrow{\langle 1_X, 0 \rangle} & X \times Y & \xleftarrow{\langle 0, 1_Y \rangle} & Y \\
 & \searrow x & \downarrow \varphi & \swarrow y & \\
 & & Z & &
 \end{array}$$

are commutative.

When two subobjects X and Y of Z commute we write $[X, Y] = 0$. In the category of monoids, two submonoids commute if and only if every element of the first commutes, in the usual sense, with every element of the second.

Proposition 6.7. *A surjective homomorphism of monoids $f: A \rightarrow B$, with kernel $k: N \rightarrow A$, is a normal extension with respect to the Galois structure Γ_{Ab} if and only if it is a special homogeneous surjection and $[N, A] = 0$.*

Proof. By definition, f is a normal extension if and only if the split epimorphism $(\pi_1: \text{Eq}(f) \rightarrow A, \Delta: A \rightarrow \text{Eq}(f))$ is a trivial extension. By Proposition 6.2, this happens if and only if N is an abelian group and there exist isomorphisms α and β of split extensions as in the diagram

$$\begin{array}{ccccc}
 N & \xrightarrow{\langle 1_N, 0 \rangle} & N \times A & \xleftarrow{\langle 0, 1_A \rangle} & A \\
 \parallel & & \alpha \downarrow \uparrow \beta & \xrightarrow{p_A} & \parallel \\
 N & \xrightarrow{\langle 0, k \rangle} & \text{Eq}(f) & \xleftarrow[\pi_1]{\Delta} & A.
 \end{array}$$

Via Proposition 6.2, it is easily seen that any split epimorphic trivial extension is a special homogeneous surjection. Then, if the surjection f is a normal extension, its kernel pair projection π_1 is a special homogeneous surjection, and hence f also is, thanks to Proposition 7.1.5 in [11]. Moreover, $[N, A] = 0$. Indeed, the cooperator $\varphi: N \times A \rightarrow A$ is given by $\varphi = \pi_2 \circ \alpha$. Let us check that it is actually a cooperator:

$$\varphi \circ \langle 1_N, 0 \rangle = \pi_2 \circ \alpha \circ \langle 1_N, 0 \rangle = \pi_2 \circ \langle 0, k \rangle = k,$$

and

$$\varphi \circ \langle 0, 1_A \rangle = \pi_2 \circ \alpha \circ \langle 0, 1_A \rangle = \pi_2 \circ \Delta = 1_A.$$

Conversely, suppose that f is special homogeneous and $[N, A] = 0$. The fact that $[N, A] = 0$ defines a morphism $\alpha: N \times A \rightarrow \text{Eq}(f)$ given by $\alpha(x, a) = (a, xa)$. Let us now describe its inverse. Since f is special homogeneous, the point $(\pi_1: \text{Eq}(f) \rightarrow A, \Delta: A \rightarrow \text{Eq}(f))$ is a special homogeneous split epimorphism. Using right homogeneity, we have that for every $(a_1, a_2) \in \text{Eq}(f)$ there exists a unique element $q(a_1, a_2) \in N$ such that

$$(a_1, a_2) = (1, q(a_1, a_2))(a_1, a_1) = (a_1, q(a_1, a_2)a_1).$$

We define a map $\beta: \text{Eq}(f) \rightarrow N \times A$ by putting $\beta(a_1, a_2) = (q(a_1, a_2), a_1)$. It is indeed the inverse of α , because

$$\alpha \circ \beta(a_1, a_2) = \alpha(q(a_1, a_2), a_1) = (a_1, q(a_1, a_2)a_1) = (a_1, a_2)$$

and

$$\beta \circ \alpha(x, a) = \beta(a, xa) = (q(a, xa), a) = (q(\langle 0, k \rangle(x)\Delta(a)), a) = (x, a),$$

where the last equality follows from Proposition 2.1.4 in [11]. Then α is an isomorphism. It clearly is a morphism of split extensions, and this concludes the proof. ■

We end with a proof that, also in the case of monoids and abelian groups, normal and central extensions coincide.

Proposition 6.8. *A surjective monoid homomorphism is a normal extension if and only if it is a central extension.*

Proof. Since every normal extension is central, we only have to prove that central extensions are normal. Let $f: A \rightarrow B$ be a central extension. Then there exists a surjective morphism $p: E \rightarrow B$ such that the morphism \bar{f} in the pullback diagram

$$\begin{array}{ccc}
 N & \xlongequal{\quad} & N \\
 \langle 0, k \rangle \downarrow & & \downarrow k \\
 P & \xrightarrow{\quad \bar{p} \quad} & A \\
 \bar{f} \downarrow & \lrcorner & \downarrow f \\
 E & \xrightarrow{\quad p \quad} & B
 \end{array}$$

is a trivial extension. Being a trivial (and hence normal) extension, \bar{f} is a special homogeneous surjection, and so f is, thanks to Proposition 7.1.5 in [11]. Moreover, $[N, P] = 0$. Hence, for all $x \in N$ and all $(e, a) \in P$, we have

$$(1, x)(e, a) = (e, a)(1, x).$$

Since \bar{p} is surjective, this implies that $ax = xa$ for all $x \in N$ and all $a \in A$, and hence $[N, A] = 0$. This proves that f is a normal extension by Proposition 6.7. ■

Acknowledgements

We are grateful to Mathieu Duckerts-Antoine, Tomas Everaert and Sandra Mantovani for helpful discussions. Special thanks to the referee for pointing out some mistakes in the first version of the text.

References

- [1] M. Barr, *Exact categories*, Exact categories and categories of sheaves, Lecture Notes in Math., vol. 236, Springer, 1971, pp. 1–120.
- [2] F. Borceux and D. Bourn, *Mal'tsev, protomodular, homological and semi-abelian categories*, Math. Appl., vol. 566, Kluwer Acad. Publ., 2004.
- [3] F. Borceux and G. Janelidze, *Galois theories*, Cambridge Stud. Adv. Math., vol. 72, Cambridge Univ. Press, 2001.
- [4] D. Bourn, *Normalization equivalence, kernel equivalence and affine categories*, Category Theory, Proceedings Como 1990 (A. Carboni, M. C. Pedicchio, and G. Rosolini, eds.), Lecture Notes in Math., vol. 1488, Springer, 1991, pp. 43–62.
- [5] D. Bourn, *Mal'tsev categories and fibration of pointed objects*, Appl. Categ. Structures **4** (1996), 307–327.
- [6] D. Bourn, *The denormalized 3×3 lemma*, J. Pure Appl. Algebra **177** (2003), 113–129.
- [7] D. Bourn, *On the monad of internal groupoids*, Theory Appl. Categ. **28** (2013), 150–165.
- [8] D. Bourn, *Mal'tsev reflection, S-Mal'tsev and S-protomodular categories*, LMPA preprint 497, 2014.
- [9] D. Bourn, *A structural aspect of the category of quandles*, J. Knot Theory Ramifications **24** (2015).
- [10] D. Bourn and M. Gran, *Regular, protomodular, and abelian categories*, Categorical Foundations: Special Topics in Order, Topology, Algebra and Sheaf Theory (M. C. Pedicchio and W. Tholen, eds.), Encyclopedia of Math. Appl., vol. 97, Cambridge Univ. Press, 2004, pp. 165–211.
- [11] D. Bourn, N. Martins-Ferreira, A. Montoli, and M. Sobral, *Schreier split epimorphisms in monoids and in semirings*, Textos de Matemática (Série B), vol. 45, Departamento de Matemática da Universidade de Coimbra, 2013.
- [12] D. Bourn, N. Martins-Ferreira, A. Montoli, and M. Sobral, *Monoids and pointed S-protomodular categories*, Homology, Homotopy Appl. **18** n.1 (2016), 151–172.
- [13] D. Bourn and D. Rodelo, *Comprehensive factorization and I-central extensions*, J. Pure Appl. Algebra **216** (2012), 598–617.
- [14] A. Carboni, G. M. Kelly, and M. C. Pedicchio, *Some remarks on Maltsev and Goursat categories*, Appl. Categ. Structures **1** (1993), 385–421.
- [15] C. Cassidy, M. Hébert, and G. M. Kelly, *Reflective subcategories, localizations and factorizations systems*, J. Austral. Math. Soc. **38** (1985), 287–329.

- [16] M. Duckerts-Antoine and T. Everaert, *A classification theorem for normal extensions*, Pré-Publicações DMUC **15–11** (2015), 1–19.
- [17] T. Everaert, *Higher central extensions in Mal'tsev categories*, Appl. Categ. Structures **22** (2014), no. 5–6, 961–979.
- [18] M. Gran, *Internal categories in Mal'cev categories*, J. Pure Appl. Algebra **143** (1999), 221–229.
- [19] M. Gran, *Applications of categorical Galois theory in universal algebra*, Galois Theory, Hopf Algebras, and Semiabelian Categories (G. Janelidze, B. Pareigis, and W. Tholen, eds.), Fields Inst. Commun., vol. 43, Amer. Math. Soc., 2004, pp. 243–280.
- [20] S. A. Huq, *Commutator, nilpotency and solvability in categories*, Q. J. Math. **19** (1968), no. 2, 363–389.
- [21] G. B. Im and G. M. Kelly, *On classes of morphisms closed under limits*, J. Korean Math. Soc. **23** (1986), 19–33.
- [22] G. Janelidze, *Pure Galois theory in categories*, J. Algebra **132** (1990), no. 2, 270–286.
- [23] G. Janelidze, *Categorical Galois theory: revision and some recent developments*, Galois connections and applications, Math. Appl., vol. 565, Kluwer Acad. Publ., 2004, pp. 139–171.
- [24] G. Janelidze and G. M. Kelly, *Galois theory and a general notion of central extension*, J. Pure Appl. Algebra **97** (1994), no. 2, 135–161.
- [25] G. Janelidze and G. M. Kelly, *The reflectiveness of covering morphisms in algebra and geometry*, Theory Appl. Categ. **3** (1997), no. 6, 132–159.
- [26] A. I. Mal'cev, *On the immersion of an algebraic ring into a field*, Math. Ann. **113** (1937), 686–691.
- [27] A. I. Mal'cev, *On the immersion of associative systems into groups, I*, Mat. Sbornik N. S. **6** (1939), 331–336.
- [28] A. I. Mal'cev, *On the immersion of associative systems into groups, II*, Mat. Sbornik N. S. **8** (1940), 241–264.
- [29] N. Martins-Ferreira and A. Montoli, *On the “Smith is Huq” condition in S-protomodular categories*, Appl. Categ. Structures, in press, DOI 10.1007/s10485-015-9411-1, 2015.
- [30] N. Martins-Ferreira, A. Montoli, and M. Sobral, *Semidirect products and crossed modules in monoids with operations*, J. Pure Appl. Algebra **217** (2013), 334–347.
- [31] N. Martins-Ferreira, A. Montoli, and M. Sobral, *Semidirect products and split short five lemma in normal categories*, Appl. Categ. Structures **22** (2014), 687–697.

- [32] A. Montoli, D. Rodelo, and T. Van der Linden, *A Galois theory for monoids*, Theory Appl. Categ. **29** (2014), no. 7, 198–214.
- [33] A. Montoli, D. Rodelo, and T. Van der Linden, *On the reflectiveness of special homogeneous surjections of monoids*, Categorical Methods in Algebra and Topology, Textos de Matemática (Série B), vol. 46, Departamento de Matemática da Universidade de Coimbra, 2014, pp. 237–244.
- [34] M. C. Pedicchio, *A categorical approach to commutator theory*, J. Algebra **177** (1995), 647–657.

CMUC, Universidade de Coimbra, 3001–501 Coimbra, Portugal
and

Institut de Recherche en Mathématique et Physique,
Université catholique de Louvain, chemin du cyclotron 2 bte L7.01.02,
1348 Louvain-la-Neuve, Belgium
email:montoli@mat.uc.pt

CMUC, Universidade de Coimbra, 3001–501 Coimbra, Portugal
and

Departamento de Matemática, Faculdade de Ciências e Tecnologia,
Universidade do Algarve, Campus de Gambelas, 8005–139 Faro, Portugal
email:drodello@ualg.pt

Institut de Recherche en Mathématique et Physique,
Université catholique de Louvain, chemin du cyclotron 2 bte L7.01.02,
B–1348 Louvain-la-Neuve, Belgium
email:tim.vanderlinden@uclouvain.be