

**ON GORENSTEIN SURFACE SINGULARITIES WITH
 FUNDAMENTAL GENUS $p_f \geq 2$ WHICH SATISFY SOME
 MINIMALITY CONDITIONS**

TADASHI TOMARU

In this paper we study normal surface singularities whose fundamental genus (:= the arithmetic genus of the fundamental cycle) is equal or greater than 2. For those singularities, we define some minimality conditions, and we study the relation between them. Further we define some sequence of such singularities, which is analogous to elliptic sequence for elliptic singularities. In the case of hypersurface singularities of Brieskorn type, we study some properties of the sequences.

Introduction.

Let $\pi : (\tilde{X}, A) \rightarrow (X, x)$ be a resolution of a normal surface singularity and, where $\pi^{-1}(x) = A = \bigcup_{i=1}^n A_i$ is the irreducible decomposition of the exceptional set A . For a cycle $D = \sum_{i=1}^n d_i A_i$ ($d_i \in \mathbb{Z}$) on A , $\chi(D)$ is defined by $\chi(D) = \dim_{\mathbb{C}} H^0(\tilde{X}, \mathcal{O}_D) - \dim_{\mathbb{C}} H^1(\tilde{X}, \mathcal{O}_D)$, where $\mathcal{O}_D = \mathcal{O}_{\tilde{X}}/\mathcal{O}(-D)$. Then

$$(0.1) \quad \chi(D) = -\frac{1}{2} (D^2 + DK_{\tilde{X}}),$$

where $K_{\tilde{X}}$ is the canonical sheaf (or divisor) on \tilde{X} . For any irreducible component A_i , we have

$$(0.2) \quad K_{\tilde{X}} A_i = -A_i^2 + 2g(A_i) - 2 + 2\delta(A_i) \quad (\text{adjunction formula}),$$

where $g(A_i)$ is the genus of the non-singular model of A_i and $\delta(A_i)$ is the degree of the conductor of A_i (cf. [7]). The arithmetic genus of $D \geq 0$ is defined by $p_a(D) = 1 - \chi(D)$. Let Z be the fundamental cycle on A (cf. [1]). Then the following three holomorphic invariants of surface singularities are defined by (cf. [1], [7]),

$$(0.3) \quad \begin{aligned} p_g &= p_g(X, x) = \dim_{\mathbb{C}} R^1 \pi_* \mathcal{O}_{\tilde{X}} && (\text{geometric genus}), \\ p_a &= p_a(X, x) = \max_{D \geq 0} p_a(D) && (\text{arithmetic genus}), \\ p_f &= p_f(X, x) = p_a(Z) && (\text{fundamental genus}). \end{aligned}$$

These values are independent of the choice of a resolution of (X, x) and there is a relation: $p_f \leq p_a \leq p_g$.

Now assume $p_f \geq 1$. Let E be the cycle on A defined by $E = \min\{D > 0 \mid p_a(D) = p_f, 0 < D \leq Z\}$ (see Definition 2.1) and let K the canonical cycle on A (cf. [24]).

In §1, we prove the followings.

Theorem 1.6. *Let (X, x) be a numerically Gorenstein surface singularity with $p_f(X, x) \geq 1$ which is not a minimally elliptic singularity. If π is the minimal resolution or the minimal good resolution, then $-K \geq Z + E$.*

In §2, we prove the following.

Theorem 2.2. *Let (X, x) be a normal surface singularity with $-K = Z + E$, then $p_g \leq p_f + 1$.*

Moreover, for normal surface singularities of $p_f \geq 2$, we consider some minimality conditions which are similar to the minimality conditions by Laufer ([7], Theorem 3.4).

In §3, we consider the fundamental cycle for normal surface singularities with star-shaped dual graphs and describe a formula of p_f for them (Theorem 3.1).

In §4, we consider hypersurface singularities of Brieskorn type with degree (a_0, a_1, a_2) (i.e., $(X, x) = \{a_0^{a_0} + x_1^{a_1} + x_2^{a_2} = 0\} \subseteq \mathbb{C}^3$). For them we prove the following two theorems.

Theorem 4.3. *If $a_2 \geq \text{l.c.m.}(a_0, a_1)$, then*

$$p_f(X, x) = \frac{1}{2} \{(a_0 - 1)(a_1 - 1) - (a_0, a_1) + 1\}.$$

Theorem 4.4. *If $\text{l.c.m.}(a_0, a_1) \leq a_2 < 2 \cdot \text{l.c.m.}(a_0, a_1)$ and $p_f(X, x) \geq 1$, then $Z = E$ on the minimal resolution.*

In Section 5, for singularities with $p_f \geq 2$, we consider sequences which are analogous to Yau's elliptic sequences. We study such sequences of hypersurface singularities of Brieskorn type and find several properties for them (Theorem 5.5).

The author would like to thank Prof. Kei-ichi Watanabe and Prof. Masataka Tomari for their helpful advice and encouragements during the preparation of this paper. In particular, Prof. Tomari kindly communicated Theorem 3.1 of this paper to the author. Also the author would like to thank Prof. Oswald Riemenschneider. He sent the author the thesis of J. Stevens

and pointed out that the minimal cycle (Definition 1.2) had already been defined in it (p. 33 in [13]).

Notations and Terminologies. For integers (or real numbers) a_1, a_2, \dots, a_n ($n \geq 2$), we put

$$[a_1, a_2, \dots, a_n] := a_1 - \frac{1}{a_2 - \frac{1}{\ddots - \frac{1}{a_n}}}$$

(continued fraction). For real number a , we put $[a] := \max\{n \in \mathbb{Z} | n \leq a\}$ (Gauss symbol) and $\{a\} = \min\{n \in \mathbb{Z} | n \geq a\}$. Further, for positive integers a_1, \dots, a_n , we put $(a_1, \dots, a_n) := g.c.m. (a_1, \dots, a_n)$.

1. Minimal cycle for normal surface singularities.

Let $\pi : (\tilde{X}, A) \rightarrow (X, x)$ be a resolution of a normal surface singularity, where $A = \bigcup_{i=1}^n A_i$ is the irreducible decomposition. Let D be a cycle with $0 \leq D < Z$, where Z is the fundamental cycle on A . Then we can construct a sequence of positive cycles $Z_0 = D, Z_1 = Z_0 + A_1, \dots, Z_i = Z_{i-1} + A_i, \dots, Z = Z_l = Z_{l-1} + A_l$ such that $Z_i A_{i+1} > 0$ for $i = \epsilon, \epsilon + 1, \dots, l - 1$, where $\epsilon = 0$ if $D > 0$ and $\epsilon = 1$ if $D = 0$. We call this sequence a computation sequence from D to Z . If $D = 0$, then it is a Laufer’s computation sequence of Z . We can always construct a computation sequence from D to Z as in [6].

Lemma 1.1. *Let D be a cycle on A such that $0 \leq D \leq Z$. Then $p_a(D) \leq p_f$.*

Proof. Let $Z_0 = D, Z_1, \dots, Z_l = Z$ be a computation sequence from D to Z . Then $p_a(Z_{i+1}) = 1 - \chi(Z_i) - \chi(A_{i+1}) + Z_i A_{i+1} = p_a(Z_i) + A_i A_{i+1} + g(A_{i+1}) - 1 \geq p_a(Z_i)$ for any i . q.e.d.

Definition 1.2. Let E be a cycle on A such that $0 < E \leq Z$. If E satisfies that $p_a(E) = p_f$ and $p_a(D) < p_f$ for any cycle D such that $D < E$, we call E a minimal cycle on A .

If (X, x) is an elliptic singularity (i.e., $p_f(X, x) = 1$), E is the minimally elliptical cycle [7]. In [13], J. Stevens had already defined the minimal cycle on the minimal resolution and he called it the characteristic cycle of (X, x) . He showed that if (X, x) is a minimal Kulikov singularity (p. 29 in [13]) and if π is the minimal resolution, then $Z = E$ on A . The existence and the uniqueness of the minimal cycle E can be shown as in [7]. Though they were also done in [13], we repeat them for the convenience to the reader.

Proposition 1.3. *For all normal surface singularities with $p_f \geq 1$, there exists a unique minimal cycle E .*

Proof. We may assume that $p_f \geq 2$. Let $B = \sum_{i=1}^n b_i A_i$ and $C = \sum_{i=1}^n c_i A_i$ be cycles such that $0 < B, C \leq Z$ and $p_a(B) = p_a(C) = p_f$. Let $m = \min(B, C) := \sum_{i=1}^n \min(b_i, c_i) A_i$, then $M \geq 0$. Since $0 < B + C - M \leq Z$, by Lemma 1.1 and (0.1),

$$\begin{aligned} 1 - p_f &\leq \chi(B + C - M) \\ &= \chi(B) + \chi(C) - \chi(M) - (B - M)(C - M) \\ &\leq 2 - 2p_f - \chi(M). \end{aligned}$$

Then $\chi(M) \leq 1 - p_f$, so $M > 0$. Further, by Lemma 1.1, $\chi(M) \geq 1 - p_f$, so $p_a(M) = p_f$. After finite steps of this process, we can obtain the minimal cycle E . q.e.d.

For the definition of the minimally elliptic cycle, we need not the assumption “ $E \leq Z$ ” (see [7]). However, in the case of $p_f \geq 2$, we need the assumption.

Lemma 1.4. *Let $Z_0 = E, Z_1 = E + A_{j_1}, \dots, Z = Z_l = E + A_{j_1} + \dots + A_{j_l}$ be a computation sequence from E to Z . Then A_{j_k} is a smooth rational curve and $Z_{k-1}A_{j_k} = 1$ for $k = 1, \dots, l$.*

Proof. We have $p_f = p_a(E) \leq p_a(Z_1) \leq \dots \leq p_a(Z_l) = p_f$ as in Lemma 1.1. Then $\chi(Z_k) - \chi(Z_{k-1}) = 0$ for $k = 1, \dots, l$. By the adjunction formula (0.2), $Z_{k-1}A_{j_k} + g(A_{j_k}) - 1 + \delta(A_{j_k}) = 0$ for any k . This completes the proof. q.e.d.

Let us define the \mathbb{Q} -coefficient cycle K on A by the relation: $A_i K = A_i K_{\bar{X}}$ for any irreducible component $A_i \subseteq A = \bigcup_{i=1}^n A_i$. We call K the canonical cycle of A (cf. [24]). If K is a \mathbb{Z} -coefficient cycle, we say that (X, x) is numerically Gorenstein. This condition does not depend on the choice of a resolution.

Now let $\sigma : (\bar{X}, \bar{A}) \rightarrow (\tilde{X}, A)$ be a monoidal transform with center $p \in A$. For any irreducible component A_i of A and $L = \sigma^{-1}(p)$, we put $\sigma^* A_i = \bar{A}_i + m_i L$, where \bar{A}_i is the proper transform of A_i and m_i is the multiplicity of A_i at p (but if $p \notin A_i$, we put $m_i = 0$). Further we put $\sigma^* D = \sum_{i=1}^n d_i \sigma^* A_i$ for any cycle $D = \sum_{i=1}^n d_i A_i$ on A .

Now let Z and K (resp. $Z_{\bar{A}}$ and $K_{\bar{A}}$) be the fundamental cycle and the canonical cycle on A (resp. \bar{A}). We put $Z = \sum_{i=1}^n z_i A_i$ and $K = \sum_{i=1}^n k_i A_i$.

Then it is well known that

$$(1.1) \quad \begin{aligned} Z_{\bar{A}} &= \sigma^* Z = \sum_{i=1}^n z_i \bar{A}_i + \left(\sum_{i=1}^n z_i m_i \right) L \quad (\text{cf. [18], Proposition 2.9}), \\ K_{\bar{A}} &= \sigma^* K + L = \sum_{i=1}^n k_i \bar{A}_i + \left(\sum_{i=1}^n k_i m_i + 1 \right) L. \end{aligned}$$

Proposition 1.5. *Assume the situation above. If $p \in \text{Supp } E$ (resp. $p \notin \text{Supp } E$), then $\sigma^* E - L$ (resp. $\sigma^* E = \sum_{i=1}^n e_i \bar{A}_i$) is the minimal cycle on \bar{A} .*

Proof. Let $\delta = 1$ (resp. $\delta = 0$) if $p \in \text{Supp } E$ (resp. if $p \notin \text{Supp } E$). Since $(\sigma^* D)L = 0$ and $(\sigma^* D_1)(\sigma^* D_2) = D_1 D_2$ for cycles D, D_1 and D_2 on A , then

$$(1.2) \quad \begin{aligned} \chi(\sigma^* D + kL) &= -\frac{1}{2} (D^2 - k^2 + K_{\bar{A}} \sigma^* D - k) \\ &= -\frac{1}{2} (D^2 + (\sigma K + L) \sigma^* D - k^2 - k) \\ &= \chi(D) + \frac{1}{2} k(k + 1), \end{aligned}$$

for any $k \in \mathbb{Z}$. Hence $p_a(\sigma^* E - \delta L) = p_f$. Suppose that $\sigma^* E - \delta L$ is not the minimal cycle on \bar{A} . Let $E_{\bar{A}} = \sum_{i=1}^n \bar{e}_i \bar{A}_i + mL (< \sigma^* E - \delta L)$ be the minimal cycle on \bar{A} , so $\bar{e}_i \leq e_i$ ($i = 1, 2, \dots, n$) and $m \leq \sum_{i=1}^n m_i e_i - \delta$, where m_i is the multiplicity of A_i at p . Assume that there is i_0 such that $\bar{e}_{i_0} < e_{i_0}$. Let $D_0 = \sum_{i=1}^n \bar{e}_i A_i$, then $D_0 < E$. From the definition of E , $p_a(D_0) < p_f$. However, the fundamental genus is independent of the choice of a resolution. Thus

$$\begin{aligned} p_f &= 1 - \chi(E_{\bar{A}}) = 1 - \chi(\sigma^* D_0 + m_0 L) \\ &= 1 - \chi(D_0) - \frac{1}{2} m_0(m_0 + 1) \leq p_a(D_0) < p_f, \end{aligned}$$

where $m_0 = m - \sum_{i=1}^n \bar{e}_i m_i$. This is a contradiction. Hence $\bar{e}_i = e_i$ for any i . Then $E_{\bar{A}} = \sigma^* E + m_0 L$. Since $p_f = p_a(E_{\bar{A}})$ and (1.2), we have $m_0 = 0$ or -1 . Then if $p \in \text{Supp } E$, $\sigma^* E - L$ is the minimal cycle on \bar{A} . If $p \notin \text{Supp } E$, then $\sigma^* E$ is the minimal cycle on \bar{A} because of $\sigma^* E - L \not\geq 0$. q.e.d.

Theorem 1.6. *Let (X, x) be a numerically Gorenstein singularity with $p_f \geq 1$ which is not a minimally elliptic singularity and let A be the exceptional set of the minimal resolution or the minimal good resolution of (X, x) . Then $-K \geq Z + E$ on A .*

Proof. Let $\pi : (\tilde{X}, A) \rightarrow (X, x)$ be the minimal resolution. Then $K \cdot A_i \geq 0$ for any i , so $-K \geq Z$. If $-K = Z$, then (X, x) is a minimally elliptic

singularity. Hence $-K > Z$. Let $M = \min(-K - Z, Z)$. Since $0 < M \leq Z$, by Lemma 1.1 and (0.1),

$$\begin{aligned} 1 - p_f &\leq \chi(M) \\ &= \chi((-K - Z) + Z - M) \\ &= \chi(-K - Z) + \chi(Z) - \chi(M) - (-K - Z - M)(Z - M) \\ &\leq 2 - 2p_f - \chi(M). \end{aligned}$$

Then $\chi(M) \leq 1 - p_f$, so $p_a(M) = p_f$. Hence we have $-K - Z \geq M \geq E$.

The minimal good resolution is obtained from the minimal resolution (\tilde{X}, A) by iterating monoidal transforms centered at points. Let $\sigma_1 : (\tilde{X}, \bar{A}) \rightarrow (\tilde{X}, A)$ be a monoidal transform at $p \in A$, where p is a singular point of an irreducible component of A or $\text{mult}_p A \geq 3$. If $p \in \text{Supp } E$, then $-K_{\bar{A}} \geq Z_{\bar{A}} + E_{\bar{A}}$ from (1.1) and Proposition 1.5. Suppose that $p \notin \text{Supp } E$. If p is a singular point of an irreducible component of A_j of A , then $A_j \not\subset \text{Supp } E$. This contradicts Lemma 1.4. Then we may assume that $\text{mult}_p A \geq 3$ and p is not a singular point of an irreducible component of A . Then there are irreducible components A_{i_1}, \dots, A_{i_s} ($s \geq 2$) which contain p . Let $Z_0 = E$, $Z_1 = Z_0 + A_{j_1}, \dots, Z_l = Z$ be a computation sequence from E to Z . Since $A_{i_k} \not\subset \text{Supp } E$ for $k = 1, \dots, s$, $\{A_{i_1}, \dots, A_{i_s}\}$ is contained in $\{A_{j_1}, \dots, A_{j_l}\}$. Then it is obvious that $Z_k A_{j_{k+1}} \geq 2$ for some k . This contradicts Lemma 1.4 again. Hence we may only consider a point in $\text{Supp } E$ as the center of σ_1 . Continuing this process, we complete the proof. q.e.d.

2. Minimality conditions for Gorenstein surface singularities.

Let (X, x) be a normal surface singularity. If there is a neighborhood U of x in X and a holomorphic 2-form ω on $U - x$ such that ω has no zeros on $U - x$, (X, x) is called to be Gorenstein. If (X, x) is Gorenstein, then it is numerically Gorenstein. If (X, x) is a Gorenstein surface singularity, the following inequality holds (cf. [5, 14, 20] for general case and [24, 25] for case of $p_g = 2$):

$$(2.1) \quad p_g(X, x) \geq p_f(X, x) + 1.$$

From Definition 1.2, Theorem 3.4 (3) in [7], Theorem 1.6 and (2.1), we can consider the following four minimality conditions I~IV respectively.

Definition 2.1. Let (X, x) be a normal surface singularity with $p_f \geq 2$ and $\pi : (\tilde{X}, A) \rightarrow (X, x)$ the minimal resolution. We consider the following four conditions:

- (I) $Z = E$ on A ,

- (II) Any connected proper subvariety of A is the exceptional set for a singularity whose fundamental genus is less than $p_f(X, x)$,
- (III) $-K = Z + E$ on A ,
- (IV) (X, x) is a Gorenstein singularity and $p_g(X, x) = p_f(X, x) + 1$.

We can easily see that I→II is always true for any normal surface singularity with $p_f \geq 1$. In the following we consider the other relation between these conditions. Under the condition that (X, x) is Gorenstein, we can show III→IV. However, we can find that there are no other good implications even for the Gorenstein case. We show this through some examples. From now on we will prove Theorem 2.3 and Corollary 2.4. We prepare the following.

Proposition 2.2. (i) $H^1(\tilde{X}, \mathcal{O}(-Z)) \simeq H^1(\tilde{X}, \mathcal{O}(-E))$,
 (ii) $H^1(\tilde{X}, \mathcal{O}_Z) \simeq H^1(\tilde{X}, \mathcal{O}_E)$,
 (iii) $H^j(\tilde{X}, \mathcal{O}_{-K-Z}) \simeq H^j(\tilde{X}, \mathcal{O}_{-K-E})$ ($j = 0, 1$).

Proof. (i) Let $Z_0 = E, Z_1 = Z_0 + A_{j_1}, \dots, Z_l = Z_{l-1} + A_{j_l} = Z$ be a computation sequence from E to Z . By Lemma 1.4, A_{j_i} is a smooth rational curve and $Z_{i-1}A_{j_i} = 1$ for $i = 1, 2, \dots, l$. From the sheaf exact sequences:

$$\begin{aligned} 0 \longrightarrow \mathcal{O}(-Z) \longrightarrow \mathcal{O}(-Z_{l-1}) \longrightarrow \mathcal{O}_{A_l}(-Z_{l-1}) \longrightarrow 0 \\ \dots \\ 0 \longrightarrow \mathcal{O}(-Z_1) \longrightarrow \mathcal{O}(-E) \longrightarrow \mathcal{O}_{A_1}(-E) \longrightarrow 0, \end{aligned}$$

we have the exact sequences of cohomology groups:

$$\begin{aligned} \dots \longrightarrow H^0(A_l, \mathcal{O}_{A_l}(-Z_{l-1})) \longrightarrow H^1(\tilde{X}, \mathcal{O}(-Z)) \\ \longrightarrow H^1(\tilde{X}, \mathcal{O}(-Z_{l-1})) \longrightarrow H^1(A_l, \mathcal{O}_{A_l}(-Z_{l-1})) \longrightarrow \dots, \\ \dots \\ \dots \longrightarrow H^0(A_1, \mathcal{O}_{A_1}(-E)) \longrightarrow H^1(\tilde{X}, \mathcal{O}(-Z_1)) \\ \longrightarrow H^1(\tilde{X}, \mathcal{O}(-E)) \longrightarrow H^1(A_1, \mathcal{O}_{A_1}(-E)) \longrightarrow \dots. \end{aligned}$$

Since $A_{i+1} \simeq \mathbb{P}_1, H^0(A_{i+1}, \mathcal{O}_{A_{i+1}}(Z_{i+1})) = H^1(A_{i+1}, \mathcal{O}_{A_{i+1}}(Z_{i+1})) = 0$ for any i . It gives the isomorphism of (i).

(ii) Let us consider the following commutative diagram:

$$\begin{array}{ccccccc} 0 & \longrightarrow & \mathcal{O}(-E) & \longrightarrow & \mathcal{O} & \longrightarrow & \mathcal{O}_E \longrightarrow 0 \\ & & \uparrow & & \parallel & & \downarrow \\ 0 & \longrightarrow & \mathcal{O}(-Z) & \longrightarrow & \mathcal{O} & \longrightarrow & \mathcal{O}_Z \longrightarrow 0. \end{array}$$

Then, from (i) we have

$$\begin{array}{ccccccc} \cdots & \rightarrow & H^1(\tilde{X}, \mathcal{O}(-E)) & \rightarrow & H^1(\tilde{X}, \mathcal{O}) & \rightarrow & H^1(\tilde{X}, \mathcal{O}_E) \rightarrow 0 \\ & & \parallel & & \parallel & & \downarrow \\ \cdots & \rightarrow & H^1(\tilde{X}, \mathcal{O}(-Z)) & \rightarrow & H^1(\tilde{X}, \mathcal{O}) & \rightarrow & H^1(\tilde{X}, \mathcal{O}_Z) \rightarrow 0, \end{array}$$

so $H^1(\tilde{X}, \mathcal{O}_E) \simeq H^1(\tilde{X}, \mathcal{O}_Z)$.

(iii) From the sheaf exact sequences:

$$0 \rightarrow \mathcal{O}_{A_{i+1}}(K_{A_{i+1}} + Z_i A_{i+1}) \rightarrow \mathcal{O}_{-K-Z_i} \rightarrow \mathcal{O}_{-K-Z_{i+1}} \rightarrow 0,$$

we have the exact sequence of cohomology groups:

$$\begin{aligned} 0 &\rightarrow H^0(A_{i+1}, \mathcal{O}_{A_{i+1}}(K_{A_{i+1}} + Z_i A_{i+1})) \rightarrow H^0(\tilde{X}, \mathcal{O}_{-K-Z_i}) \\ &\rightarrow H^0(\tilde{X}, \mathcal{O}_{-K-Z_{i+1}}) \rightarrow H^1(A_{i+1}, \mathcal{O}_{A_{i+1}}(K_{A_{i+1}} + Z_i A_{i+1})) \\ &\rightarrow H^1(\tilde{X}, \mathcal{O}_{-K-Z_i}) \rightarrow H^1(\tilde{X}, \mathcal{O}_{-K-Z_{i+1}}) \rightarrow 0 \quad (i = 0, 1, \dots, l-1). \end{aligned}$$

Since

$$H^0(A_{i+1}, \mathcal{O}_{A_{i+1}}(K_{A_{i+1}} + Z_i A_{i+1})) = H^1(A_{i+1}, \mathcal{O}_{A_{i+1}}(K_{A_{i+1}} + Z_i A_{i+1})) = 0$$

for any i ,

$$\begin{aligned} H^j(\tilde{X}, \mathcal{O}_{-K-Z}) &\simeq H^j(\tilde{X}, \mathcal{O}_{-K-Z_{l-1}}) \simeq \\ &\cdots \simeq H^j(\tilde{X}, \mathcal{O}_{-K-Z_i}) \simeq H^j(\tilde{X}, \mathcal{O}_{-K-E}) \end{aligned}$$

for $j = 0, 1$. q.e.d.

Theorem 2.3. *Let (X, x) be a normal surface singularity with $-K = Z + E$, then $p_g(X, x) \leq p_f(X, x) + 1$.*

Proof. We may assume that $p_f(X, x) \geq 1$ and $p_g(X, x) \geq 2$. Let $\pi : (\tilde{X}, A) \rightarrow (X, x)$ be a resolution and $A = \bigcup_{i=1}^n A_i$ the irreducible decomposition. Let $Z_1 = A_1, Z_2 = Z_1 + A_2, \dots, Z = Z_l = Z_{l-1} + A_l$ be a computation sequence of the fundamental cycle Z on A , so $Z_i A_{i+1} > 0$ for $i = 1, \dots, l-1$. From the sheaf exact sequences:

$$\begin{aligned} 0 &\rightarrow \mathcal{O}(K + Z_1)/\mathcal{O}(K) \rightarrow \mathcal{O}_{-K} \rightarrow \mathcal{O}_{-K-Z_1} \rightarrow 0, \\ &\dots \\ 0 &\rightarrow \mathcal{O}(K + Z)/\mathcal{O}(K + Z_{l-1}) \rightarrow \mathcal{O}_{-K-Z_{l-1}} \rightarrow \mathcal{O}_{-K-Z} \rightarrow 0, \end{aligned}$$

we have the exact sequences of cohomology groups

$$\begin{aligned} \dots &\rightarrow H^1(\tilde{X}, \mathcal{O}(K + Z_1)/\mathcal{O}(K)) \\ &\rightarrow H^1(\tilde{X}, \mathcal{O}_{-K}) \rightarrow H^1(\tilde{X}, \mathcal{O}_{-K-Z_1}) \rightarrow 0, \\ &\dots \\ \dots &\rightarrow H^1(\tilde{X}, \mathcal{O}(K + Z)/\mathcal{O}(K + Z_{l-1})) \\ &\rightarrow H^1(\tilde{X}, \mathcal{O}_{-K-Z_{l-1}}) \rightarrow H^1(\tilde{X}, \mathcal{O}_{-K-Z_l}) \rightarrow 0. \end{aligned}$$

Further,

$$\begin{aligned} H^1(\tilde{X}, \mathcal{O}(K + Z_1)/\mathcal{O}(K)) &\simeq H^1(A_1, \mathcal{O}_{A_1}(K + A_1)) \\ &\simeq H^1(A_1, \mathcal{O}(K_{A_1})) \simeq \mathbb{C}, \end{aligned}$$

and

$$\begin{aligned} H^1(\tilde{X}, \mathcal{O}(K + Z_{i+1})/\mathcal{O}(K + Z_i)) &\simeq H^1(A_{i+1}, \mathcal{O}_{A_{i+1}}(K + Z_{i+1})) \\ &\simeq H^1(A_{i+1}, \mathcal{O}(K_{A_{i+1}} + A_{i+1}Z_i)) \simeq H^0(A_{i+1}, \mathcal{O}(-A_{i+1}Z_i)) = 0. \end{aligned}$$

Therefore we have

$$h^1(\tilde{X}, \mathcal{O}_{-K}) - h^1(\tilde{X}, \mathcal{O}_{-K-Z}) \leq 1.$$

On the other hand, it is well known that $p_g(X, x) = \dim_{\mathbb{C}} H^1(\tilde{X}, \mathcal{O}) = \dim_{\mathbb{C}} H^1(\tilde{X}, \mathcal{O}_{-K})$ (cf. [7] and [24]) and $p_f(X, x) = \dim_{\mathbb{C}} H^1(\tilde{X}, \mathcal{O}_Z)$. By Proposition 2.2 (ii), $p_f(X, x) = \dim_{\mathbb{C}} H^1(\tilde{X}, \mathcal{O}_E) = \dim_{\mathbb{C}} H^1(\tilde{X}, \mathcal{O}_{-K-Z})$. Hence we have $p_g(X, x) - p_f(X, x) \leq 1$. q.e.d.

From (2.1) we have the following.

Corollary 2.4. *Let (X, x) be a Gorenstein surface singularity with $p_g(X, x) \geq 2$. If $-K = Z + E$, then $p_g(X, x) = p_f(X, x) + 1$.*

Let C be a curve of genus 2 and L a line bundle on C with $2L = K_C$, where K_C is the canonical bundle of C . We assume that $H^0(C, \mathcal{O}(L)) = 0$. For example, if we take L as $\mathcal{O}(P_1 + P_2 - P_3)$ with three different Weierstrass points P_1, P_2 and P_3 , then it satisfies the conditions above. Let (X, x) be the singularity from the contraction of the zero section of the negative line bundle $-L$. Then it is a Gorenstein singularity satisfying $p_g = 3$ (see [10]) and $p_f = 2$, but $-K = 3C > Z + E = 2C$. Therefore the converse of corollary 2.4 does not hold.

Example 2.5. Let $(X, x) = \{x_0^2 + x_1^7 + x_2^{10} = 0\} \subseteq \mathbb{C}^3$ (a hypersurface singularity). The w.d. graph (weighed dual graph) associated to (X, x) is

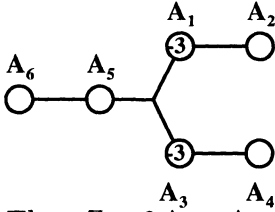

Then $Z = 2A_1 + A_2 + 2A_3 + A_4 + 3A_5 + 2A_6$ and $p_f = 2$, so $E = 2A_1 + A_2 + 2A_3 + A_4 + 2A_5 + A_6$. We can easily check that (X, x) satisfies the condition II and $Z > E$. This shows that $\text{II} \rightarrow \text{I}$.

Example 2.6. Let $(X, x) = \{x_0^2 + x_1^7 + x_2^{21} = 0\} \subseteq \mathbb{C}^3$. The w.d. graph is

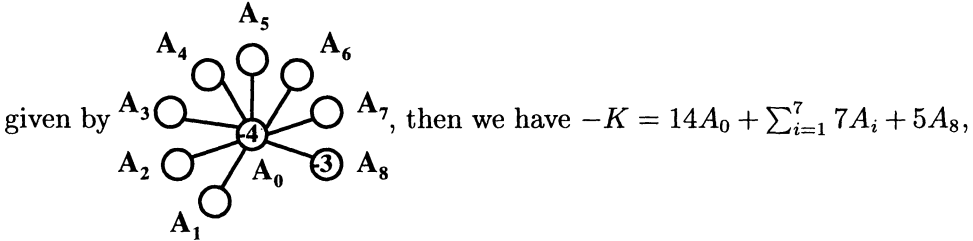

given by $-K = 14A_0 + \sum_{i=1}^7 7A_i + 5A_8$,

$Z = E = 2A_0 + \sum_{i=1}^7 A_i + A_8$, $p_f = 3$ and $p_g = 12$ (cf. [21]). This shows $\text{I} \rightarrow \text{IV}$.

Example 2.7. (i) Let (X, x) be the 5-th Veronese quotient [16] of the hypersurface singularity $\{x_0^3 + x_1^6 + x_2^{12} = 0\} \subseteq \mathbb{C}^3$. Then the w.d. graph for

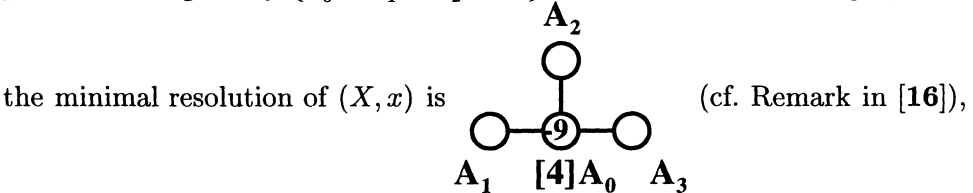

the minimal resolution of (X, x) is (cf. Remark in [16]),

$Z = A_0 + A_1 + A_2 + A_3$ and $p_f = 4$. Moreover we can see that $E = A_0$, and $-K = Z + E$. This singularity is Gorenstein and $p_g = 5$. This example shows $\text{III} \rightarrow \text{I}$.

Example 2.8. Let (X, x) be the 9-th Veronese quotient of a hypersurface singularity $\{x_0^4 + x_1^5 + x_2^{10} = 0\} \subseteq \mathbb{C}^3$. The w.d. graph is given by

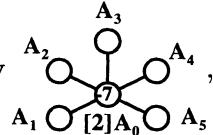

then $-K = 2A_0 + \sum_{i=1}^5 A_i$, $Z = A_0 + \sum_{i=1}^5 A_i$ and $p_f = 2$. Then $-K = Z + E$. Further, (X, x) is Gorenstein and $p_g = 3$. It is obvious that (X, x) does not satisfy II. This shows $\text{III} \rightarrow \text{II}$.

From examples above, we can find that even for Gorenstein case, there are not any implications between four conditions of Definition 2.1 except for

the two implications: I→II and III→IV.

3. Fundamental genus of normal surface singularities with star-shaped dual graph.

Let $\pi : (\tilde{X}, A) \rightarrow (X, x)$ be the minimal good resolution of a normal surface singularity whose w.d. graph is given by

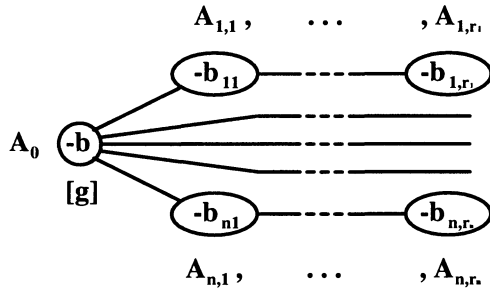

(3.1)

where $A_{i,j} \simeq \mathbb{P}^1$ for $i = 1, \dots, n$; $j = 1, \dots, r_i$, and A_0 is a curve of genus g which is called the central curve. Let (Y_i, y_i) be the singularity which is obtained by the blowing-down of the i -th branch $\overline{(-b_{i1})} \cdots \overline{(-b_{ir_i})}$ ($i = 1, \dots, n$). It is isomorphic to the cyclic quotient singularity $C_{d_i;1,e_i} = \mathbb{C}^2 / \langle \left(\begin{smallmatrix} e_{d_i} & 0 \\ 0 & e_{d_i}^{e_i} \end{smallmatrix} \right) \rangle$, where $\frac{d_i}{e_i} = [b_{i1}, \dots, b_{ir_i}]$ (continued fraction). We call (d, e) (resp. d) the cyclic type (resp. the cyclic order) of $C_{d;1,e}$. We denote \mathbb{Q} -coefficient divisor D and \mathbb{Z} -coefficient divisor $[kD]$ on A_0 as follows:

$$(3.2) \quad D := D_0 - \sum_{i=1}^n \frac{e_i}{d_i} P_i \quad \text{and} \quad [kD] + kD_0 - \sum_{i=1}^n \left\{ \frac{ke_i}{d_i} \right\} P_i,$$

where k is a non-negative integer and D_0 is a divisor on A_0 such that $\mathcal{O}_{A_0}(D_0)$ is the restriction to A_0 of the conormal sheaf of A_0 in \tilde{X} .

When (X, x) has a good \mathbb{C}^* -action, H. Pinkham [10] wrote the affine graded ring R_X of (X, x) in terms of the above numerical data as follows:

$$R_X = R(A_0, D) = \bigoplus_{k=0}^{\infty} H^0(A_0, \mathcal{O}_{A_0}([kD])) \cdot t^k.$$

We call this representation Pinkham’s construction. This was generalized to higher dimensional case by M. Demazure [3], so the divisor D is called Demazure’s divisor.

Now let us compute the fundamental cycle Z on an exceptional set A with star-shaped dual graph and the fundamental genus p_f . Let m be the

coefficient of Z on A_0 . For $k = 1, \dots, m$, let $Z^{(k)}$ be a minimal divisor such that $0 < Z^{(k)} \leq Z$ and the coefficient of $Z^{(k)}$ on A_0 is k and $Z^{(k)} A_{i,j} \leq 0$ for any i, j . Then a unique cycle $Z^{(k)}$ exists. It is easy to see that there is a computation sequence $Z_0 = 0, Z_1 = A_0, Z_2 = Z_1 + A_1, \dots, Z_{k_1} = Z^{(1)}, Z_{k_1+1} = Z_{k_1} + A_{k_1+1}, \dots, Z_{k_2} = Z^{(2)}, Z_{k_2+1} = Z_{k_2} + A_{k_2+1}, \dots, Z^{(m)} = Z$ which satisfies $Z_j A_{k+1} = 1$ for $A_{k+1} \neq A_0$, where $A_{k_i+1} = A_0$ ($i = 1, \dots, m - 1$) and other A_k is a component $A_{i,j}$ of a cyclic branch. We call this a good computation sequence.

Let $\tau : (\tilde{X}, A) \rightarrow (\bar{X}, \bar{A}_0)$ be the contraction of all cyclic quotient branches $C_{d_i:1,e_i}$ ($i = 1, \dots, n$) and $\bar{A}_0 = \tau(A_0)$. In §6 in [15], M. Tomari and K-i. Watanabe studied the Giraud’s inverse image of $k\bar{A}_0$ (it is denoted by L_k), where k is an integer. From the definition of L_k and the considerations in (6.11) of [15], we can easily see that

$$(3.3) \quad -L_{-k} = Z^{(k)} \quad (k = 1, \dots, m) \quad \text{and} \quad -L_{-m} = Z.$$

Further, from Lemma 6.14 and (6.15) in [15], we can see the followings:

$$(3.4) \quad -L_{-k} A_0 = kD_0 - \sum_{i=1}^n \left\{ \frac{ke_i}{d_i} \right\} \cdot p_i \quad (= [kD]), \text{ and}$$

$$m = \text{the coefficient of } Z \text{ on } A_0 = \min \{k \in \mathbb{N} \mid \text{deg}[kD] \geq 0\}.$$

The following result is due to Tomari, and we describe it according to his suggestion.

Theorem 3.1 (M. Tomari). $p_f(X, x) = \sum_{k=0}^{m-1} \dim_{\mathbb{C}} H^1(A_0, \mathcal{O}_{A_0}([kD]))$.

Proof. Let $Z_0 = 0, A_1 = A_{i_1}, Z_2 = Z_1 + A_{i_2}, \dots, Z_{s_m} = Z^{(m)} = Z$ be a good computation sequence which contains the subsequence $\{Z^{(1)}, \dots, Z^{(m)}\}$ such as $Z^{(1)} = Z_{s_1}, \dots, Z^{(m)} = Z_{s_m}$. Then $s_m = s_{m-1} + 1$ and A_{i_j} is equal to A_0 for $i_j = s_k + 1$. Let us consider the following sheaf exact sequences:

$$\begin{aligned} 0 \rightarrow \mathcal{O}(-Z)/\mathcal{O}(-Z_1) \rightarrow \mathcal{O}_{-Z_1} \rightarrow 0, \\ 0 \rightarrow \mathcal{O}(-Z_1)/\mathcal{O}(-Z_2) \rightarrow \mathcal{O}_{Z_2} \rightarrow \mathcal{O}_{Z_1} \rightarrow 0, \\ \dots \\ 0 \rightarrow \mathcal{O}(-Z_{s_{m-1}})/\mathcal{O}(-Z) \rightarrow \mathcal{O}_Z \rightarrow \mathcal{O}_{Z_{s_{m-1}}} \rightarrow 0. \end{aligned}$$

Then $H^0(\tilde{X}, \mathcal{O}_{Z_j}) = \mathbb{C}$ for $j = 1, \dots, s_m$ (cf. [7, (2.6)]). If $A_{i_j} \neq A_0$, then A_{i_j} is a smooth rational curve and $Z_{i_{j-1}} A_{i_j} = 1$. Hence $H^1(A_{i_j}, \mathcal{O}(-Z_{i_{j-1}} A_{i_j})) = 0$ for $i_j = s_k + 1, \dots, s_{k+1} - 1$ and $k = 0, 1, \dots, m$. Therefore

$$0 \rightarrow H^1(A_0, \mathcal{O}(-Z_{s_k} A_0)) \rightarrow H^1(\tilde{X}, \mathcal{O}_{Z_{s_k+1}}) \rightarrow H^1(\tilde{X}, \mathcal{O}_{Z_{s_k}}) \rightarrow 0,$$

$$(k = 0, 1, \dots, m - 1),$$

$$0 \rightarrow H^1(\tilde{X}, \mathcal{O}_{Z_{j+1}}) \rightarrow H^1(\tilde{X}, \mathcal{O}_{Z_j}) \rightarrow 0,$$

$$(k = 0, 1, \dots, m - 1; j = s_k + 1, \dots, s_{k+1} - 1).$$

Hence

$$\begin{aligned} p_f(X, x) &= \dim_{\mathbb{C}} H^1(\tilde{X}, \mathcal{O}_Z) \\ &= \sum_{k=0}^{m-1} \dim_{\mathbb{C}} H^1(A_0, \mathcal{O}(-Z_{s_k} A_0)) \\ &= \sum_{k=0}^{m-1} \dim_{\mathbb{C}} H^1(A_0, \mathcal{O}(-L_{-k} A_0)) \\ &= \sum_{k=0}^{m-1} \dim_{\mathbb{C}} H^1(A_0, \mathcal{O}([kD])). \quad \text{q.e.d.} \end{aligned}$$

For normal surface singularities with \mathbb{C}^* -action, similar formulas for the geometric genus and the arithmetic genus were already proved in [10] and [14] respectively.

From now on, we prepare two lemmas for the proof of Theorem 4.4 by using (3.4). Let $A = \bigcup_{i=0}^N A_i$ be an exceptional set with star-shaped dual graph with central curve A_0 . We consider a cyclic branch $\bigcup_{i=1}^n A_i$ with

$A_0 \cup A_1 \neq \emptyset$. Let $\textcircled{-b_1} - \dots - \textcircled{-b_n}$ be the w.d. graph of $\bigcup_{i=1}^n A_i$, where $A_i^2 = -b_i$. Let $\frac{d}{e} = [b_1, \dots, b_n]$ (continued fraction), where $(d, e) = 1$. Let $c_0 = d$, $c_1 = e$ and let c_2, c_3, \dots, c_n be the integers which are inductively defined by the relation $c_{i+1} = b_i c_i - c_{i-1}$ ($1 \leq i \leq n - 1$), so $c_n = 1$ and $c_{i+1} < b_i$ ($1 \leq i \leq n - 1$). From (3.4), we can easily see that if we put $m_0 = m$, $m_i = \left\{ \frac{c_i m_{i-1}}{c_{i-1}} \right\}$ for $(i = 1, \dots, n)$, then

$$(3.5) \quad \text{the restriction } Z|_{\bigcup_{i=1}^n A_i} = \sum_{i=1}^n m_i A_i,$$

i.e., the coefficient of Z on A_i is equal to m_i . Then we obtain the following.

Lemma 3.2. *Suppose that the coefficient for the fundamental cycle Z on A_0 is ds (s is a positive integer). Then the coefficient for Z on A_i is given by sc_i for $i = 1, \dots, n$. In particular, $ZA_i = 0$ for $i = 1, \dots, n$.*

Let d, e and b_1, \dots, b_n be as above. Let l, μ be integers such that $\mu d - el = 1$ and $0 < \mu < d$. Then we have $\frac{l}{\mu} = [b_1, \dots, b_{n-1}, b_n - 1]$. Therefore if we

put $\lambda_0 = l$, $\lambda_1 = \mu$ and define $\lambda_2, \dots, \lambda_n$ inductively by $\lambda_i = b_{i-1}\lambda_{i-1} - \lambda_{i-2}$ ($i = 2, \dots, n$), then $\lambda_{n-1} = b_n - 1$, $\lambda_n = 1$.

Lemma 3.3. (i) *If the coefficient for Z on A_0 is l , the coefficient for Z on A_i is given by λ_i ($i = 1, \dots, n$). In particular, $ZA_i = 0$ for $i = 1, \dots, n - 1$ and $ZA_n = -1$.*

(ii) *If $\left[\frac{d}{l}\right] = 1$, then $b_n \geq 3$.*

Proof. (i) is easily obtained from (3.5), so only consider (ii). Assume that $b_n = 2$. Since $(d - l)e \equiv 1 \pmod d$, $\frac{d}{d - l} = [2, b_{n-1}, \dots, b_1]$. Then $0 < [b_{n-1}, \dots, b_1] = \frac{d - l}{d - 2l} < 0$. This is a contradiction. q.e.d.

4. Hypersurface singularities of Brieskorn type.

Let (X, x) be a 2-dimensional hypersurface singularity of Brieskorn type, so the defining polynomial is given by $x_0^{a_0} + x_1^{a_1} + x_2^{a_2}$ for integers a_0, a_1, a_2 . We call (a_0, a_1, a_2) the degree of (X, x) . In this section we consider the fundamental genus and minimalities for such singularities. For the degree (a_0, a_1, a_2) , we denote positive integers d_0, \dots, d_6 as follows:

$$(4.1) \quad \begin{aligned} d_6 &= (a_0, a_1, a_2) (= g.c.m. (a_0, a_1, a_2)), \quad d_{i+3} = \frac{a_{\langle i+1 \rangle} a_{\langle i+2 \rangle}}{d_6}, \\ d_i &= \frac{a_i}{d_{3+\langle i+1 \rangle} d_{3+\langle i+2 \rangle} d_6}, \quad l_i = d_{\langle i+1 \rangle} d_{\langle i+2 \rangle} d_{3+i} \quad (i = 0, 1, 2), \end{aligned}$$

where for an integer i , $\langle i \rangle$ is the integer satisfying $\langle i \rangle \equiv i \pmod 3$ and $0 \leq \langle i \rangle \leq 2$. Hence we have $(d_{\langle i \rangle}, d_{\langle i+1 \rangle}, d_{\langle i+2 \rangle}) (d_{\langle i \rangle+3}, d_{\langle i+1 \rangle+3}, d_{\langle i+2 \rangle+3}) = (d_i, d_{\langle i+3 \rangle}) = 1$ and $l_i = \frac{l.c.m.(a_0, a_1, a_2)}{a_i}$ for $i = 0, 1, 2$. Let e_i be an integer which is determined by $e_i l_i + 1 \equiv 0 \pmod{d_i}$ ($0 \leq e_i < d_i$) for $i = 0, 1, 2$. Then, by the results in [9], the w.d. graph associated to the minimal good resolution of (X, x) is a star-shaped graph whose associated cyclic branches have at most three types as follows:

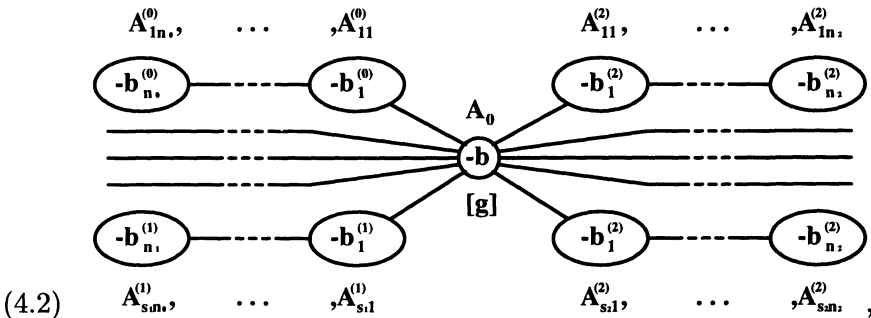

where $\frac{d_i}{e_i} = [b_1^{(i)}, \dots, b_n^{(i)}]$ (continued fraction) and $s_i = (a_{(i+1)}, a_{(i+2)}) = d_6 d_{3+i}$ ($i = 0, 1, 2$). If $d_i = 1$, then $e_i = 0$. In this case we put $n_i = 0$. Further, the Demazure's divisor D is given as follows:

$$(4.3) \quad D = D_0 - \sum_{i=0}^2 \sum_{j=1}^{s_i} \frac{e_i}{d_i} P_{i,j},$$

where $\deg D_0 = \frac{d_6}{d_0 d_1 d_2} + \sum_{i=0}^2 \frac{s_i e_i}{d_i}$ by Theorem 3.6.1 in [9]. The next lemma is easy, so omit the proof.

Lemma 4.2. *Let e, l and d be positive integers which satisfy $le + 1 \equiv 0 \pmod{d}$ and $0 < e < d$. Then*

$$\sum_{k=1}^{l-1} \left(\left\{ \frac{ke}{d} \right\} - \frac{ke}{d} \right) = \frac{(l-1)(d+1)}{2d} - \left[\frac{l}{d} \right].$$

(ii) *Let e and d be relatively prime positive integers with $0 < e < d$, and let a be any positive integer. Then*

$$\sum_{k=1}^{ad-1} \left(\left\{ \frac{ke}{d} \right\} - \frac{ke}{d} \right) = \frac{a(d-1)}{2}$$

Theorem 4.3. *Let (X, x) be a hypersurface singularity of Brieskorn type with degree (a_0, a_1, a_2) . If $a_2 \geq \text{l.c.m.}(a_0, a_1)$, then*

$$p_f(X, x) = \frac{1}{2} \{ (a_0 - 1)(a_1 - 1) - (a_0, a_1) + 1 \}.$$

Proof. From (3.2) and (4.3), we have

$$\deg[kD] = \frac{kd_6}{d_0 d_1 d_2} - \sum_{i=0}^2 d_{3+i} d_6 \left(\left\{ \frac{ke_i}{d_i} \right\} - \frac{ke_i}{d_i} \right),$$

where k is a non-negative integer. For an integer t with $0 < t < l_2$, we have

$$\begin{aligned} \deg[(l_2 - t)D] &\leq \frac{(l_2 - t)d_6}{d_0 d_1 d_2} - d_5 d_6 \left(\left\{ \frac{(l_2 - t)e_2}{d_2} \right\} - \frac{(l_2 - t)e_2}{d_2} \right) \\ &< d_5 d_6 \left(\frac{1}{d_2} - \left\{ \frac{(l_2 - t)e_2}{d_2} \right\} + \frac{(l_2 - t)e_2}{d_2} \right). \end{aligned}$$

Since $a_2 \geq \text{l.c.m.}(a_0, a_1)$, $d_2 > l_2 - t$ for $t > 0$. Then $(l_2 - t)e_2$ is not divisible by d_2 , because of $(d_2, e_2) = 1$. Then $\deg[(l_2 - t)D] < 0$, and $\deg[l_2 D] =$

$d_5 d_6 \left(\left\{ \begin{matrix} l_2 e_2 \\ e_2 \end{matrix} \right\} \right) - \frac{l_2 e_2}{e_2} = 0$ since $l_2 e_2 + 1 \equiv 1 \pmod{d_2}$. Therefore, from (3.4), $m :=$ the coefficient of Z on $A_0 = \min \{k \in \mathbb{N} \mid \deg[kD] \geq 0\} = l_2$. By Theorem 3.1,

$$p_f(X, x) = \sum_{k=0}^{l_2-1} \dim_{\mathbb{C}} H^0(A_0, \mathcal{O}_{A_0}(K_{A_0} - [kD])).$$

Since $\deg[kD] < 0$ for $0 < k \leq l_2 - 1$, $H^1(A_0, \mathcal{O}_{A_0}(K_{A_0} - [kD])) = 0$. Hence, by Riemann-Roch theorem on curves,

$$p_f(X, x) = \sum_{k=1}^{l_2-1} \{-\deg([kD]) + g(A_0) - 1\} + 1.$$

Since $0 < l_2 < d_2$ and $(l_2, d_2) = 1$, by Lemma 4.2 we have

$$\frac{d_0 d_1 d_2}{d_6} \cdot \sum_{k=1}^{l_2-1} \deg[kD] = \frac{l_2}{2} \{-l_0 d_0 - l_1 d_1 - l_2 d_2 + l_0 + l_1 + d_2\}.$$

Combining Proposition 3.5.1 in [9], we obtain

$$\begin{aligned} p_f(X, x) &= 1 + \frac{l_2}{2} \left\{ d_3 d_4 d_5 d_6^2 - \frac{d_3 d_6}{d_0} - \frac{d_4 d_6}{d_1} - \frac{d_6}{d_0 d_1} \right\} \\ &= \frac{1}{2} \{(a_0 - 1)(a_1 - 1) - (a_0, a_1) + 1\}. \quad \text{q.e.d.} \end{aligned}$$

Theorem 4.4. *Let (X, x) be a hypersurface singularity of Brieskorn type with degree (a_0, a_1, a_2) . If $\text{l.c.m.}(a_0, a_1) \leq a_2 < 2 \cdot \text{l.c.m.}(a_0, a_1)$ and $p_f(X, x) \geq 1$, then (X, x) satisfies the minimality condition I of Definition 2.1.*

Proof. Suppose that the minimal good resolution of (X, x) whose w.d. graph is given by (4.2). It suffices to prove that $p_a(Z - A_i) < p_f$ for any irreducible component A_i of the exceptional set A of the minimal resolution. By the definition of p_a ,

$$(4.4) \quad p_a(Z - A_i) = p_f - ZA_i + A_i^2 - g(A_i) + 1 - \delta(A_i).$$

First we consider the case that the minimal good resolution is equal to the minimal resolution (i.e., the central curve A_0 is not an exceptional set of 1-st kind). By (3.4), the coefficient of Z on A_0 is $d_0 d_1 d_5$, so by Lemma 3.2,

$$(4.5) \quad \begin{aligned} ZA_{jk}^{(i)} &= 0 \text{ and } p_z(Z - A_{jk}^{(i)}) < p_f \\ (i = 0, 1; j = 1, \dots, s_i; k = 1, \dots, n_i). \end{aligned}$$

Since $l.c.m.(a_0, a_1) \leq a_2 < 2 \cdot l.c.m.(a_0, a_1)$, $l_2 \leq d_2 < 2l_2$ (i.e., $\left\lfloor \frac{d_2}{l_2} \right\rfloor = 1$).

By Lemma 3.3, we have

$$(4.6) \quad \begin{aligned} ZA_{jk}^{(2)} &= 0 \quad (j = 1, \dots, s_2; k = 1, \dots, n_2 - 1), \\ ZA_{jn_2}^{(2)} &= -1 \text{ and } (A_{jn_2}^{(2)})^2 < -2 \quad (j = 1, \dots, s_2). \end{aligned}$$

Thus $p_a(Z - A_{jk}^{(2)}) < p_f$ from (4.4). Therefore we may only prove that $p_a(Z - A_0) < p_f$. From Lemma 3.2, the coefficient of Z on $A_{j1}^{(0)}$ (resp. $A_{j1}^{(1)}$) is $e_0d_1d_5$ (resp. $e_1d_0d_5$) for $j = 1, \dots, s_0 = d_3d_6$ (resp. $j = 1, \dots, s_1 = d_4d_6$). By Lemma 3.2 (i) the coefficient of Z on $A_{j1}^{(2)}$ ($j = 1, \dots, d_5d_6$) is μ , where μ is the positive integer which is determined by $d_2\mu - e_2l_2 = 1$ and $0 < \mu < l_2$.

Further, by Theorem 3.6.1 in [9], $b = \frac{\prod_{i=0}^6 d_i}{l_0l_1l_2} + \frac{e_0d_3d_6}{d_0} + \frac{e_1d_4d_6}{d_1} + \frac{e_2d_5d_6}{d_2}$.

Then

$$\begin{aligned} ZA_0 &= -l_2b + e_0d_1d_3d_5d_6 + e_1d_0d_4d_5d_6 + \mu d_5d_6 \\ &= \frac{d_5d_6}{d_2}(1 + e_2l_2 - \mu d_2) = 0. \end{aligned}$$

Therefore $p_a(Z - A_0) = p_f + A_0^2 - g(A_0) + 1 < p_f$ by (4.4).

Next we assume that the central curve A_0 is an exceptional curve of the first kind. Let $\pi = \tau \circ \sigma : (\bar{X}, \bar{A}) \xrightarrow{\sigma} (\bar{X}, A) \xrightarrow{\tau} (X, x)$ be the minimal good resolution, where τ is the minimal resolution and σ is a birational morphism obtained by iterating monoidal transforms centered at a point. We may assume that \bar{A} contains more than two irreducible components. We have to prove $p_a(Z - A_i) < p_f$ for any i , where $Z = Z_A$. Suppose $p_a(Z - A_i) = p_f$ for some i . By Lemma 1.4, A_i is a smooth rational curve. From (4.4), $ZA_i = A_i^2 + 1$. Let \bar{A}_i be the proper transform of A_i by σ . From (0.2.2) in [18] and Lemma 3.2, 3.3 (i), we have $ZA_i = Z_{\bar{A}}\bar{A}_i = 0$ or -1 . Since τ is the minimal resolution, we have $ZA_i = -1$ and $A_i^2 = -2$. Hence \bar{A}_i is equal to $A_{j_0n_2}^{(2)}$ for some j_0 by Lemma 3.3 (i). Hence the coefficient of $Z_{\bar{A}}$ on \bar{A}_i is 1. By (1.1), the coefficient on Z on A_i is 1. Since $ZA_i = -1$, there is only one irreducible component $A_j \subseteq A$ such that $A_i \cap A_j \neq \emptyset$. A_i intersects transversely at a smooth point of A_j . Therefore we may assume that τ doesn't contain any monoidal transform centered at a point of A_i , so $\bar{A}_i^2 = A_i^2$. Then $(A_{j_0n_2}^{(2)})^2 = \bar{A}_i^2 = -2$, this contradicts Lemma 3.3 (ii). q.e.d.

In [13], J. Stevens proved that if (X, x) is a minimal Kulikov singularity and if $\pi : (\bar{X}, A) \rightarrow (X, x)$ is the minimal resolution, then $Z = E$ on A . Hence if we can prove that all singularities as in Theorem 4.4 are minimal Kulikov, then it gives a proof of Theorem 4.4. However, the author doesn't know the proof until now.

In elliptic case (i.e., $(a_0, a_1) = (2, 3)$ or $(2, 4)$ or $(3, 3)$), the result of Theorem 4.4 is already known by the classification of minimally elliptic singularities (cf. H. Laufer [7] and M. Reid [11]). Further, the similar property as (ii) does not hold in general quasi-homogeneous hypersurface singularities. For example, let $(X, x) = \{x_0^3 + x_0x_1^5 + x_2^{a_2} = 0\} \subseteq \mathbb{C}^3$. If $a_2 \geq 15$ (resp. $a_2 < 15$), then $p_f(X, x) = 6$ (resp. $p_f(X, x) < 6$). However, (X, x) does not satisfy the minimality condition I of Definition 2.1 for any $a_2 \geq 15$. For example, if $a_2 = 15$, then the w.d. graph of (X, x) is $\begin{matrix} \textcircled{2} \text{---} \textcircled{} \\ \text{[6]} \end{matrix}$.

5. Yau sequence of hypersurface singularities of Brieskorn type.

Let $(\tilde{X}, a) \rightarrow (X, x)$ be the minimal good resolution of a normal surface singularity (X, x) with $p_f(X, x) \geq 1$. We give the following definition which is an analogue to elliptic sequence (cf. S.S.T.-Yau [24], Definition 3.3).

Definition 5.1. If $ZE < 0$, we say that the Yau sequence is $\{Z\}$. Suppose $ZE = 0$. Let B_1 be the maximal connected subvariety of A such that $B_1 \supseteq \text{supp } E$ and $A_iZ = 0$ for any $A_i \subseteq B_1$. Since $Z^2 < 0$, B_1 is properly contained in A . Suppose $Z_{B_1}E = 0$. Let B_2 be the maximal connected subvariety of B_1 such that $B_2 \supseteq \text{supp } E$ and $A_iZ_{B_1} = 0$ for any $A_i \subseteq B_2$. By the same argument as above, B_2 is properly contained in B_1 . We continue this process. Finally if we obtain B_m with $Z_{B_m}E < 0$, we call $\{Z_{B_0} = Z, Z_{B_1}, \dots, Z_{B_m}\}$ the *Yau sequence* of (X, x) and the *length of Yau sequence* is $m + 1$. We call a connected component of $\bigcup_{A_i \subseteq \text{supp } E} A_i$ an *eliminative branch* of (X, x) .

Let $\{Z, Z_{B_1}, \dots, Z_{B_m}\}$ be the Yau sequence of (X, x) and (X_{B_i}, x_i) the normal surface singularity obtained by the contraction of B_i for $i = 0, 1, \dots, m$. By Lemma 1.1 we have $p_f(X_{B_1}, x_1) = \dots = p_f(X_{B_m}, x_m) = p_f$.

In this section we study Yau sequence whose member are hypersurface singularities of Brieskorn type. Yau showed a following fact which is important in his theory. Namely if (X, x) is a numerically Gorenstein elliptic singularity, then $-K_{B_i} - (-K_{B_{i+1}}) = cZ_{B_i}$ for any i , where K_{B_i} is the canonical cycle on B_i (cf. Proof of Theorem 3.7 in [24]). For the case with $p_f \geq 2$, we consider a similar property:

$$(5.1) \quad -K_{B_i} - (-K_{B_{i+1}}) = cZ_{B_i} \quad (i = 0, 1, \dots, m - 1),$$

where $c \in \mathbb{Q}$ is a suitable positive rational number. However this condition doesn't hold in general case. For example, let (X, x) be a singularity whose w.d. graph is

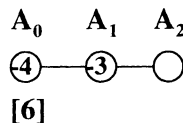

so $-K_A = 19A_0 + 8A_1 + 4A_2$ and $Z = Z_A = A_0 + A_1 + A_2$ and $E = A_0$. Since $B_1 = A_0 \cup A_1$, we have $-K_{B_1} = 17A_0 + 6A_1$ and $Z_{B_1} = A_0 + A_1$. Then (X, x) does not satisfy (5.2), so we consider a more restrictive situation in the following.

Proposition 5.2. *Suppose that $p_f(X, x) \geq 1$ and the length of the Yau sequence is $t + 1$. Let $(\tilde{X}, A) \rightarrow (X, x)$ be the minimal good resolution. Assume $Z_{B_m} = E$, and assume that $A_i^2 = -2$ and the coefficient for Z on A_i is 1 for every $A_i \notin \text{supp } E$. Then the w.d. graph of A is given as follows:*

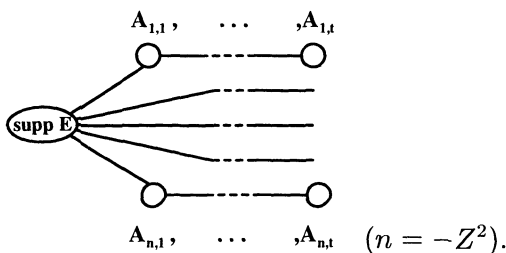

Further, assume that (X, x) satisfy one of the following (i) or (ii).

- (i) Yau sequence of (X, x) has one eliminative branch,
- (ii) the w.d. graph for (X, x) is star-shaped and every cyclic branch which contains an eliminative branch has the same cyclic type (see §3).

Then $-K_{B_i} - (-K_{B_{i+1}}) = \frac{2p_f - 2 + n}{n} Z_{B_i}$ for $i = 0, 1, \dots, t - 1$.

Proof. Let $D = \sum_{A_i \notin \text{supp } E} A_i$. It is easy to see that $Z = E + D$ and the coefficient for E on any irreducible component of $\text{supp } E$ which intersects to an eliminative branch is always one. Since $ZE = 0$, $-E^2 = ED$ is the number of eliminative branches. Further any eliminative branch is a chain whose any component is a rational curve with the self-intersection number -2 . Hence the weighted dual graph of A has the form:

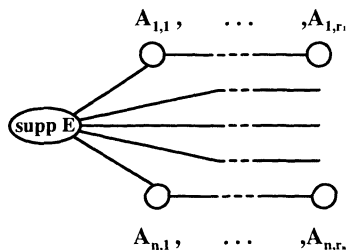

If $r_1 = r_2 = \dots = r_k < r_{k+1} \leq \dots \leq r_n$ ($0 \leq k < n$), then B_{r_1} has $n - k$ eliminative branches. But $-E^2 = n > n - k$ is the number of the eliminative branches of $(X_{B_{r_1}}, x_{r_1})$. This contradicts to the fact above, so $r_1 = r_2 = \dots = r_n = t$. Further $Z^2 = ZD = -n$.

Now we assume that (X, x) satisfies (i) or (ii), so the coefficient of $-K$ on A_{ij} is independent of i ($i = 1, \dots, n$). We put $-K = \sum_{i=1}^s a_i A_i + \sum_{i=1}^n \sum_{j=1}^t x_j A_{ij}$, where $\text{supp } E = \bigcup_{i=1}^s A_i$. Then $0 = -K A_{1,t} = x_{t-1} - 2x_t$, $0 = -K A_{1,i} = x_{i-1} - 2x_i + x_{i+1}$ ($i = 1, \dots, t-1$). Therefore we have $-K = \sum_{i=1}^s a_i A_i + c \sum_{i=1}^n \sum_{j=1}^t (t-j) A_{ij}$, where c is a constant. Similarly we have $-K_{B_1} = \sum_{i=1}^s b_i A_i + c_1 \sum_{i=1}^n \sum_{j=1}^{t-1} (t-j-1) A_{ij}$. It is easy to see that $(-K - (K_{B_1})) A_i = c_1 Z A_i$ for any i . Then $-K - (K_{B_1}) = c_1 Z$. Comparing the both coefficients on A_{it} , we have $c = c_1$. Hence $-K - (K_{B_1}) = cZ$. Continuing this process, we obtain that $-K_{B_i} - (K_{B_{i+1}}) = cZ_{B_i}$ ($i = 0, 1, \dots, t-1$). Since $-K - (-K_{B_1}) = cZ$ and $ZK_{B_1} = 0$, $-KZ = cZ^2$. Then

$$c = \frac{KZ}{-Z^2} = \frac{2p_f - 2 - Z^2}{Z^2} = \frac{2p_f - 2 + n}{n}. \quad \text{q.e.d.}$$

Example 5.3. Under the above condition, let (X, x) be a singularity such that $\text{supp } E$ is a smooth irreducible curve A_0 with genus g and $A_0^2 = -n$. Then we have

$$\begin{aligned} -K &= \frac{2g - 2 + n}{n} \{Z + Z_{B_1} + \dots + Z_{B_{t-1}} + A_0\} \\ &= \frac{2g - 2 + n}{n} \left\{ (t+1)A_0 + \sum_{i=1}^n \sum_{j=1}^t (t-j+1)A_{ij} \right\}. \end{aligned}$$

For example, let $(X, x) = \{x_0^{a_0} + x_1^{a_1} + x^{l.c.m.(a_0, a_1)(t+1)} = 0\} \subseteq \mathbb{C}^3$, where t is a non-negative integer. Then the w.d. graph is given by the above, where $n = (a_0, a_1)$ and $g = \frac{(a_0 - 1)(a_1 - 1) - (a_0, a_1) + 1}{2}$. Then

$$-K = \frac{a_1 a_1 - a_0 - a_1}{(a_0, a_1)} \{Z + Z_{B_1} + \dots + Z_{B_{t-1}} + E\}.$$

For fixed integers a_0, a_1, a_2 satisfying $2 \leq a_0 \leq a_1$ and $l.c.m.(a_0, a_1) \leq a_2 < 2 \cdot l.c.m.(a_0, a_1)$, let $f_t = x_0^{a_0} + x_1^{a_1} + x^{a_2 + l.c.m.(a_0, a_1)t}$ and $(X_t, x_t) = \{f_t = 0\} \subseteq \mathbb{C}^3$, where t is a non-negative integer. We consider a sequence $\Sigma(a_0, a_1, a_2)$ as follows:

$$(5.2) \quad \Sigma(a_0, a_1, a_2) := \{(X_t, x_t) | t = 0, 1, 2, \dots\}.$$

From Theorem 4.3, $p_f(X_t, x_t) = \frac{1}{2} \{(a_0 - 1)(a_1 - 1) - (a_0, a_1) + 1\}$ for any $t \geq 0$ and (X_0, x_0) satisfies the minimality condition I of Definition 2.1. Yau has studied such sequences as examples of the elliptic sequence (cf.

[23], Example 4, 5, 6 and 7. In our notation, they correspond to $\Sigma(2, 3, 9)$, $\Sigma(2, 3, 11)$, $\Sigma(3, 3, 4)$ and $\Sigma(3, 3, 5)$ respectively). In the following, we generalize his results to $\Sigma(a_0, a_1, a_2)$.

Lemma 5.4. *Let λ, l , and d be integers satisfying $l\lambda + 1 \equiv 0 \pmod d$ and $0 < l, \lambda < d$. For a non-negative integer t , let λ_t be an integer satisfying $l\lambda_t + 1 \equiv 0 \pmod{lt + d}$ and $0 < \lambda_t < lt + d$. If $\frac{d}{\lambda} = [b_1, \dots, b_n]$, then $\frac{lt + d}{\lambda_t} = [b_1, \dots, b_n, \underbrace{2, \dots, 2}_t]$.*

Proof. It suffices to prove the only case of $t = 1$. Since $(d - l)\lambda \equiv 1 \pmod d$, $\frac{d}{d - l} = [b_n, \dots, b_1]$ and

$$\frac{d + l}{d} = 2 - \frac{1}{\frac{d}{d - l}} = [2, b_n, \dots, b_1].$$

Further, $d\lambda_1 \equiv 1 \pmod{(l + d)}$, $\frac{l + d}{\lambda_1} = [b_n, \dots, b_1, 2]$. q.e.d.

Theorem 5.5. *Let a_0, a_1 and a_2 be fixed integers satisfying $2 \leq a_0 \leq a_1$ and $\text{l.c.m.}(a_0, a_1) \leq a_2 < 2 \cdot \text{l.c.m.}(a_0, a_1)$. Then we have the following result about $\Sigma(a_0, a_1, a_2)$.*

(i) *If the w.d. graph associated with the minimal good resolution of (X_0, x_0) is given by (4.2), the w.d. graph of (X_t, x_t) is given as follows:*

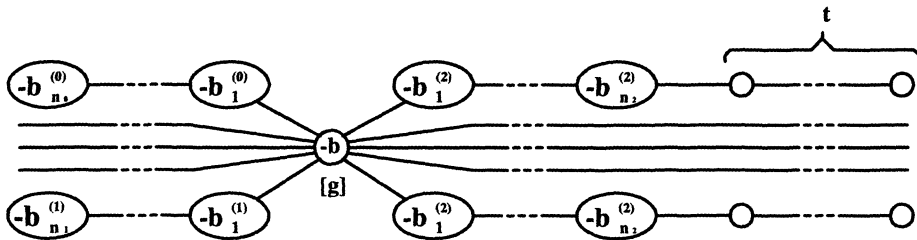

Hence, the length of the Yau sequence of (X_t, x_t) is $t + 1$.

(ii) Let $\{Z, Z_{B_1}, \dots, Z_{B_{t-1}}, Z_{B_t}\}$ be the Yau sequence of (X_t, x_t) . Then

$$(X_{B_i}, x_i) = (X_{t-1}, x_{t-1}) \in \Sigma(a_0, a_1, a_2) \text{ for } i = 0, 1, \dots, t,$$

where (X_{B_i}, x_i) is the singularity obtained by the contraction of B_i .

(iii) $-K_t - (-K_{t-1}) = \frac{a_0 a_1 - a_0 - a_1}{(a_0, a_1)} Z_t$ ($t = 1, 2, \dots$), where K_t (resp. Z_t) is the canonical (resp. fundamental) cycle on the exceptional set of the minimal good resolution of (X_t, x_t) .

(iv) $p_g(X_t, x_t) - p_g(X_{t-1}, x_{t-1}) = p_g(Y, y)$ ($t = 1, 2, \dots$), where $(Y, y) = \{x_0^{a_0} + x_1^{a_1} + x_2^{l.c.m.(a_0, a_1)} = 0\} \subseteq \mathbb{C}^3$ (see Example 5.3). Thus $p_g(X_t, x_t) - p_g(X_{t-1}, x_{t-1})$ is independent of t and a_2 .

Proof. (i) is obvious from Lemma 5.4 and Theorem 4.4.

For (ii), we describe the outline of the proof. It suffices to compare the other data of Pinkham’s construction except for cyclic branches (i.e., an analytic type of the central curve, the normal bundle of the central curve, intersection points of the central curve and branches) between (X_0, x_0) and (X_t, x_t) for any t . If it is showed, then for fixed value \bar{t} , the data above of $(X_{\bar{t}-i}, x_{\bar{t}-i})$ and (X_0, x_0) are equal. Because of $(X_{B_0}, x_0) = (X_{\bar{t}}, x_{\bar{t}})$, the data of (X_{B_i}, x_i) is equal to (X_0, x_0) . Hence, comparing the cyclic branches, the all data of Pinkham’s constructions of (X_{B_i}, x_i) and $(X_{\bar{t}-i}, x_{\bar{t}-i})$ are equal.

Hence we compare those data for (X_0, x_0) and (X_t, x_t) in $\Sigma(a_0, a_1, a_2)$. Let $C_0 \subseteq \mathbb{P}(l_0, l_1, l_2)$ (resp. $C_t \subseteq \mathbb{P}(L_0, L_1, d_2l_2)$) be the central curve for (X_0, x_0) (resp. (X_t, x_t)), where $L_i = l_i(d_2 + l_2t)$ for $i = 0, 1, 2$. Let $\pi_0 : \mathbb{P}^2 \rightarrow \mathbb{P}(l_0, l_1, l_2)$ be a map defined by $\pi_0([z_0 : z_1 : z_2]) = [z_0^{L_0} : z_1^{L_1} : z_2^{L_2}]$ and let $\pi_1 : \mathbb{P}^2 \rightarrow \mathbb{P}(L_0, L_1, d_2l_2)$ be a map defined by $\pi_0([z_0 : z_1 : z_2]) = [z_0^{L_0} : z_1^{L_1} : z_2^{d_2l_2}]$. They are surjective, so we can define $\varphi : \mathbb{P}(l_0, l_1, l_2) \rightarrow \mathbb{P}(L_0, L_1, d_2l_2)$ by $\varphi(\pi_0(p)) = \pi_1(p)$ for $p \in \mathbb{P}^2$. Then φ is an isomorphism (cf. [4]) and $\varphi(C_0) = C_t$. Since $\varphi(\{x_i = 0\} \cap C_0) = \{y_0\} \cap C_t$, φ corresponds the intersection points (of C_0 and branches) for (X_0, x_0) to those for (X_t, x_t) . Further, let D_0 (resp. D_t) be a divisor associated to the conormal bundle of C_0 (resp. C_t). Then D_0 can be written as $D_0 = \sum_{j=1}^N r_j P_j$ and we have $D_t = \sum_{j=1}^N r_j \varphi(P_j)$ (cf. [9], 3.6), where $\{P_1, \dots, P_N\} \subseteq \bigcup_{i=0}^2 \{x_i = 0\} \cap C_0$. Hence, each Pinkham-Demazure’s data for (X_0, x_0) and (X_t, x_t) are equal except for the type of cyclic quotient singularities of branches. This shows (ii).

(iii) is obvious by Proposition 5.2.

Now we prove (iv). We put $p := (a_0, a_1)$, $p_0 := \frac{a_0}{p}$, $p_1 := \frac{a_1}{p}$ and $\bar{p} := l.c.m.(a_0, a_1) = pp_0p_1$. Then f_t is a quasi-homogeneous polynomial of the type $(\bar{p}; p_1, p_0, \frac{\bar{p}}{a_2 + \bar{p}t})$. From Ki. Watanabe’s results ([20], Theorem 1.13),

$$p_g(X_t, x_t) = \# \left\{ i = (i_0, i_1, i_2) \in \mathbb{N}^3 \mid 0 \leq p_1 i_0 + p_0 i_1 + \frac{\bar{p}}{a_2 + \bar{p}t} i_2 \leq a(t) \right\},$$

where $a(t) = \bar{p} - p_1 - p_0 - \frac{\bar{p}}{a_2 + \bar{p}t}$ and \mathbb{N} is the set of non-negative integers.

We put $I_0 = \{i_0 \in \mathbb{N} \mid p_1 i_0 \leq a(t)\} = \left\{ i_0 \in \mathbb{N} \mid i_0 \leq pp_0 - 1 - \frac{p_0}{p_1} - \frac{pp_0}{a_2 + \bar{p}t} \right\}$.

Since $(p_0, p_1) = 1$, $\left\{ \frac{p_0}{p_1} + \frac{pp_0}{a_2 + \bar{p}t} \right\} = \varepsilon_0$, where $\varepsilon_0 = 1$ (resp. 0) if $p_0 \neq p_1$ (resp. $p_0 = p_1$). Then $I_0 = \{i_0 \in \mathbb{N} \mid i_0 \leq pp_0 - 1 - \varepsilon_0\}$. For any element $i_0 \in I_0$, let $I(i_0) = \{i_1 \in \mathbb{N} \mid 0 \leq p_0 i_1 \leq a(t) - p_1 i_0\}$. Since $\bar{p} \leq a_2 < 2\bar{p}$, $I(i_0) = \left\{ i_1 \in \mathbb{N} \mid i_1 \leq pp_1 - \frac{p_1(i_0 + 1)}{p_0} - 1 - \varepsilon_1 \right\}$, where ε_1 is 1 (resp. 0) if $p_0 \mid i_0 + 1$ (resp. $p_0 \nmid i_0 + 1$). Therefore I_0 and $I(i_0)$ ($\forall i_0 \in I_0$) are determined by a_0 and a_1 . For $i_0 \in I_0$ and $i_1 \in I(i_0)$, let $B(i_0, i_1) = \bar{p} - p_1(i_0 + 1) - p_0(i_1 + 1)$. Then

$$p_g(X_t, x_t) = \# \left\{ i \in \mathbb{N}^3 \mid i_0 \in I_0, i_1 \in I(i_0) \text{ and } i_2 + 1 \leq \left(\frac{a_2}{p} + t \right) B(i_0, i_1) \right\}.$$

Hence $p_g(X_{t+1}, x_{t+1}) - p_g(X_t, x_t)$ is independent of t and a_2 . If $a_2 = l.c.m.(a_0, a_1)$, then $p_g(X_{t+1}, x_{t+1}) - p_g(X_t, x_t) = p_g(Y, y)$ for any t . q.e.d.

From results above we can easily see that if $t > 0$, then (X_t, x_t) does not satisfy any minimality condition of Definition 2.1.

Example 5.6. Let $(X_t, x_t) = \{x_0^2 + x_1^8 + x_2^{a_2+8t} = 0\} \subseteq \mathbb{C}^3$ for a non-negative integer t , where $8 \leq a_2 < 16$. Then $p_f(X_t, x_t) = 3$ and $-K_{t+1} - (-K_t) = 3Z_{t+1}$ for any $t \geq 0$.

(i) Let $a_2 = 9$, then w.d. graph of (X_t, x_t) is

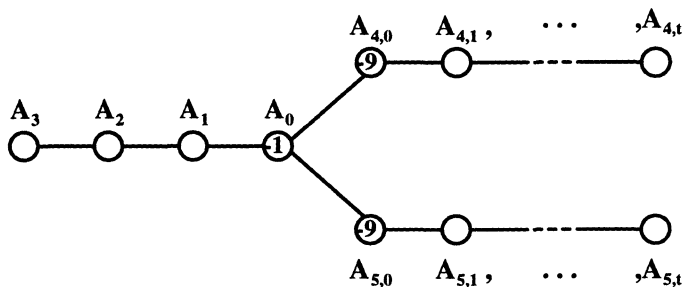

Then $Z_t = 8A_0 + 6A_1 + 4A_2 + 2A_3 + \sum_{i=0}^t A_{4,i} + \sum_{i=0}^t A_{5,i}$, $E = 4A_0 + 3A_1 + 2A_2 + A_3 + A_{4,0} + A_{5,0}$, $-K_0 = 20A_0 + 15A_1 + 10A_2 + 5A_3 + 3A_{4,0} + 3A_{5,0}$ and $p_g(X_t, x_t) = 6t + 6$ for any $t \geq 0$.

(ii) Let $a_2 = 12$, then w.d. graph of (X_t, x_t) is

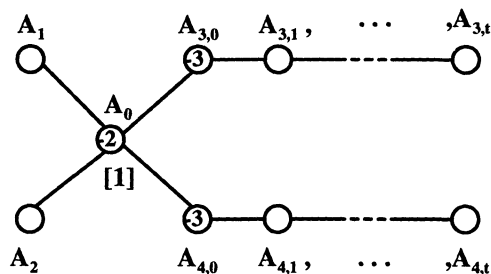

Then $Z_t = 2A_0 + A_1 + A_2 + \sum_{i=0}^t A_{3,i} + \sum_{i=0}^t A_{4,i}$, $E = 2A_0 + A_1 + A_2 + A_{3,0} + A_{4,0}$, $-K_0 = 8A_0 + 4A_1 + 4A_2 + 3A_{3,0} + 3A_{4,0}$ and $p_g(X_t, x_t) = 6t + 8$ for any $t \geq 0$.

In Example 5.6, though $p_f(X_t, x_t)$ is equal to 3 for any $t \geq 0$, the arithmetic genus is given by $p_a(X_t, x_t) = 2t + 3$ ($t \geq 0$) (cf. [14]). From this we can see that the arithmetic genus and the fundamental genus have different roles as the invariant for normal surface singularities with $p_f \geq 2$, though both are topological invariants.

References

- [1] M. Artin, *On isolated rational singularities of surfaces*, Amer. J. Math., **88** (1963), 129–138.
- [2] E. Brieskorn, *Rational Singularitäten komplexer Flächen*, Inve. Math., **4** (1969), 336–358.
- [3] M. Demazure, *Anneaux gradués normaux*, in Séminaire Demazure-Giraud-Teissier, Singularities des surfaces, École Polytechnique (1979).
- [4] I.V. Dolgachev, *Weighted projected varieties*, Group Actions and Vector Fields (Proc. Polish-North Ameri. Sem., Vancouver (1981)), Lecture Notes in Math., 956, Springer-Verlag (1982), 34–71.
- [5] F. Hidaka and K-i. Watanabe, *Normal Gorenstein surfaces with ample canonical divisor*, Tokyo J. Math., **4** (1989), 319–330.
- [6] H. Laufer, *On rational singularities*, Amer. J. Math., **94** (1972), 597–608.
- [7] ———, *On minimally elliptic singularities*, Amer. J. Math., **99**, No. 6 (1977), 1257–1295.
- [8] M. Oka, *On the Resolution of the Hypersurface Singularities*, Adv. Stud. in Pure Math., **8** (1986), 405–436.
- [9] P. Orlik and P. Wagreich, *Isolated singularities of algebraic surface with \mathbb{C}^* -action*, Ann. of Math., **93** (1971), 205–228.
- [10] H. Pinkham, *Normal surface singularities with \mathbb{C}^* -action*, Math. Ann., **227** (1977), 183–193.
- [11] M. Reid, *Elliptic Gorenstein singularities of surfaces*, Preprint, 1978.
- [12] O. Riemenschneider, *Deformationen von Quotientensingularitäten (nach zyklischen Gruppen)*, Math. Ann., **209** (1974), 211–248.

- [13] J. Stevens, *Kulikov Singularities*, Thesis, 1985.
- [14] M. Tomari, *Maximal-Ideal-Adic Filtration on $R^1\phi_*\mathcal{O}_{\tilde{V}}$ for Normal Two-Dimensional Singularities*, Adv. Stud. in Pure Math., **8** (1986), 633–647.
- [15] M. Tomari and K-i. Watanabe, *Filtered Rings, Filtered Blowing-Ups and Normal Two-Dimensional Singularities with “Star-Shaped” Resolution*, Publ. Res. Inst. Math. Soc., Kyoto Univ., **25** (1989), 681–740.
- [16] T. Tomaru, *Cyclic quotients of 2-dimensional quasi-homogeneous hypersurface singularities*, Math. Z., **210** (1992), 225–244.
- [17] ———, *On numerically Gorenstein quasi-simple elliptic singularities with \mathbb{C}^* -action*, Proc. Amer. Math. Soc., **120** (1994), 67–71.
- [18] P. Wagreich, *Elliptic singularities of surfaces*, Amer. J. Math., **92** (1970), 421–454.
- [19] K-i. Watanabe, *Some remarks concerning Demazure’s construction of normal graded rings*, Nagoya Math. J., **83** (1981), 203–211.
- [20] Ki. Watanabe, *On plurigenera of normal isolated singularities I*, Math. Ann., **250** (1980), 65–94.
- [21] ———, *On plurigenera of normal isolated singularities II*, Adv. Stud. in Pure Math., **8** (1986), 671–685.
- [22] S.S.-T. Yau, *Normal two-dimensional elliptic singularities*, Trans. Amer. Math. Soc., **254** (1979), 117–134.
- [23] ———, *On strongly elliptic singularities*, Amer. J. Math., **101** (1979), 855–884.
- [24] ———, *On maximally elliptic singularities*, Trans. Amer. Math. Soc. (2), **257** (1980), 269–329.
- [25] E. Yoshinaga and S. Ohyanagi, *A criterion for 2-dimensional normal singularities to weakly elliptic*, Sci. Rep. Yokohama National Univ. Sec 2, **26** (1979), 5–7.

Received November 23, 1992.

COLLEGE OF MEDICAL CARE AND TECHNOLOGY
 GUNMA UNIVERSITY
 MAEBASHI, GUNMA 371
 JAPAN

