

A FINITE GENERATING SET FOR THE LEVEL 2 TWIST SUBGROUP OF THE MAPPING CLASS GROUP OF A CLOSED NON-ORIENTABLE SURFACE

RYOMA KOBAYASHI and GENKI OMORI

(Received December 9, 2015, revised June 20, 2016)

Abstract

We obtain a finite generating set for the level 2 twist subgroup of the mapping class group of a closed non-orientable surface. The generating set consists of crosscap pushing maps along non-separating two-sided simple loops and squares of Dehn twists along non-separating two-sided simple closed curves. We also prove that the level 2 twist subgroup is normally generated in the mapping class group by a crosscap pushing map along a non-separating two-sided simple loop for genus $g \geq 5$ and $g = 3$. As an application, we calculate the first homology group of the level 2 twist subgroup for genus $g \geq 5$ and $g = 3$.

1. Introduction

Let $N_{g,n}$ be a compact connected non-orientable surface of genus $g \geq 1$ with $n \geq 0$ boundary components. The surface $N_g = N_{g,0}$ is a connected sum of g real projective planes. The mapping class group $\mathcal{M}(N_{g,n})$ of $N_{g,n}$ is the group of isotopy classes of self-diffeomorphisms on $N_{g,n}$ fixing the boundary pointwise and the twist subgroup $\mathcal{T}(N_{g,n})$ of $\mathcal{M}(N_{g,n})$ is the subgroup of $\mathcal{M}(N_{g,n})$ generated by all Dehn twists along two-sided simple closed curves. Lickorish [7] proved that $\mathcal{T}(N_g)$ is an index 2 subgroup of $\mathcal{M}(N_g)$ and the non-trivial element of $\mathcal{M}(N_g)/\mathcal{T}(N_g) \cong \mathbb{Z}/2\mathbb{Z} =: \mathbb{Z}_2$ is represented by a “Y-homeomorphism”. We define a Y-homeomorphism in Section 2. Chillingworth [1] gave an explicit finite generating set for $\mathcal{T}(N_g)$ and showed that $\mathcal{T}(N_2) \cong \mathbb{Z}_2$. The first homology group $H_1(G)$ of a group G is isomorphic to the abelianization G^{ab} of G . The group $H_1(\mathcal{T}(N_g))$ is trivial for $g \geq 7$, $H_1(\mathcal{T}(N_3)) \cong \mathbb{Z}_{12}$, $H_1(\mathcal{T}(N_4)) \cong \mathbb{Z}_2 \oplus \mathbb{Z}$ and $H_1(\mathcal{T}(N_g)) \cong \mathbb{Z}_2$ for $g = 5, 6$. These results were shown by Korkmaz [5] for $g \geq 7$ and by Stukow [10] for the other cases.

Let $\Sigma_{g,n}$ be a compact connected orientable surface of genus $g \geq 0$ with $n \geq 0$ boundary components. The mapping class group $\mathcal{M}(\Sigma_{g,n})$ of $\Sigma_{g,n}$ is the group of isotopy classes of orientation preserving self-diffeomorphisms on $\Sigma_{g,n}$ fixing the boundary pointwise. Let S be either $N_{g,n}$ or $\Sigma_{g,n}$. For $n = 0$ or 1 , we denote by $\Gamma_2(S)$ the subgroup of $\mathcal{M}(S)$ which consists of elements acting trivially on $H_1(S; \mathbb{Z}_2)$. $\Gamma_2(S)$ is called the *level 2 mapping class group* of S . For a group G , a normal subgroup H of G and a subset X of H , H is *normally generated in G by X* if H is the normal closure of X in G . In particular, for $X = \{x_1, \dots, x_n\}$, if H is the normal closure of X in G , we also say that H is *normally generated in G by x_1, \dots, x_n* . In the case of orientable surfaces, Humphries [3] proved that $\Gamma_2(\Sigma_{g,n})$ is normally generated in $\mathcal{M}(\Sigma_{g,n})$ by the square of the Dehn twist along a non-separating simple closed

curve for $g \geq 1$ and $n = 0$ or 1 . In the case of non-orientable surfaces, Szepietowski [11] proved that $\Gamma_2(N_g)$ is normally generated in $\mathcal{M}(N_g)$ by a Y-homeomorphism for $g \geq 2$. Szepietowski [12] also gave an explicit finite generating set for $\Gamma_2(N_g)$. This generating set is minimal for $g = 3, 4$. Hirose and Sato [2] gave a minimal generating set for $\Gamma_2(N_g)$ when $g \geq 5$ and showed that $H_1(\Gamma_2(N_g)) \cong \mathbb{Z}_2^{\binom{g}{3} + \binom{g}{2}}$.

We denote by $\mathcal{T}_2(N_g)$ the subgroup of $\mathcal{T}(N_g)$ which consists of elements acting trivially on $H_1(N_g; \mathbb{Z}_2)$ and we call $\mathcal{T}_2(N_g)$ the *level 2 twist subgroup of $\mathcal{M}(N_g)$* . Recall that $\mathcal{T}(N_2) \cong \mathbb{Z}_2$ and Chillingworth [1] proved that $\mathcal{T}(N_2)$ is generated by the Dehn twist along a non-separating two-sided simple closed curve. $\mathcal{T}_2(N_2)$ is a trivial group because Dehn twists along non-separating two-sided simple closed curves induce nontrivial actions on $H_1(N_g; \mathbb{Z}_2)$. Let $\text{Aut}(H_1(N_g; \mathbb{Z}_2), \cdot)$ be the group of automorphisms on $H_1(N_g; \mathbb{Z}_2)$ preserving the intersection form \cdot on $H_1(N_g; \mathbb{Z}_2)$. Since the action of $\mathcal{M}(N_g)$ on $H_1(N_g; \mathbb{Z}_2)$ preserves the intersection form \cdot , there is the natural homomorphism from $\mathcal{M}(N_g)$ to $\text{Aut}(H_1(N_g; \mathbb{Z}_2), \cdot)$. McCarthy and Pinkall [8] showed that the restriction of the homomorphism to $\mathcal{T}(N_g)$ is surjective. Thus $\mathcal{T}_2(N_g)$ is finitely generated.

In this paper, we give an explicit finite generating set for $\mathcal{T}_2(N_g)$ (Theorem 3.1). The generating set consists of “crosscap pushing maps” along non-separating two-sided simple loops and squares of Dehn twists along non-separating two-sided simple closed curves. We review the crosscap pushing map in Section 2. We can see the generating set for $\mathcal{T}_2(N_g)$ in Theorem 3.1 is minimal for $g = 3$ by Theorem 1.2. We prove Theorem 3.1 in Section 3. In the last part of Subsection 3.2, we also give the smaller finite generating set for $\mathcal{T}_2(N_g)$ (Theorem 3.14). However, the generating set consists of crosscap pushing maps along non-separating two-sided simple loops, squares of Dehn twists along non-separating two-sided simple closed curves and squares of Y-homeomorphisms.

By using the finite generating set for $\mathcal{T}_2(N_g)$ in Theorem 3.1, we prove the following theorem in Section 4.

Theorem 1.1. *For $g = 3$ and $g \geq 5$, $\mathcal{T}_2(N_g)$ is normally generated in $\mathcal{M}(N_g)$ by a crosscap pushing map along a non-separating two-sided simple loop (see Figure 1).*

$\mathcal{T}_2(N_4)$ is normally generated in $\mathcal{M}(N_4)$ by a crosscap pushing map along a non-separating two-sided simple loop and the square of the Dehn twist along a non-separating two-sided simple closed curve whose complement is a connected orientable surface (see Figure 2).

The x-marks as in Figure 1 and Figure 2 mean Möbius bands attached to boundary components in this paper and we call the Möbius band the *crosscap*. The group which is normally generated in $\mathcal{M}(N_g)$ by the square of the Dehn twist along a non-separating two-sided simple closed curve is a subgroup of $\mathcal{T}_2(N_g)$ clearly. The authors do not know whether $\mathcal{T}_2(N_g)$ is generated by squares of Dehn twists along non-separating two-sided simple closed curves or not.

As an application of Theorem 1.1, we calculate $H_1(\mathcal{T}_2(N_g))$ for $g \geq 5$ in Section 5 and we obtain the following theorem.

Theorem 1.2. *For $g = 3$ and $g \geq 5$, the first homology group of $\mathcal{T}_2(N_g)$ is as follows:*

$$H_1(\mathcal{T}_2(N_g)) \cong \begin{cases} \mathbb{Z}^2 \oplus \mathbb{Z}_2 & \text{if } g = 3, \\ \mathbb{Z}_2^{\binom{g}{3} + \binom{g}{2} - 1} & \text{if } g \geq 5. \end{cases}$$

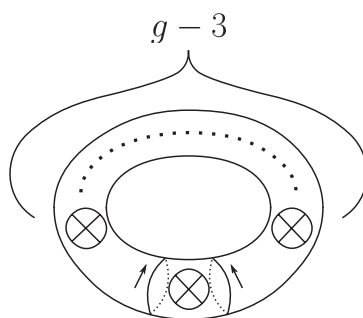

FIG. 1. A crosscap pushing map along a non-separating two-sided simple loop is described by a product of Dehn twists along non-separating two-sided simple closed curves as in the figure.

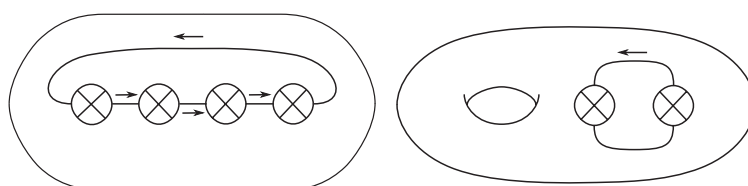

FIG. 2. A non-separating two-sided simple closed curve on N_4 whose complement is a connected orientable surface.

In this proof, we use the five term exact sequence for an extension of a group for $g \geq 5$. The authors do not know the first homology group of $\mathcal{T}_2(N_4)$.

2. Preliminaries

2.1. Crosscap pushing map. Let S be a compact surface and let $e : D' \hookrightarrow \text{int}S$ be a smooth embedding of the unit disk $D' \subset \mathbb{C}$. Put $D := e(D')$. Let S' be the surface obtained from $S - \text{int}D$ by the identification of antipodal points of ∂D . We call the manipulation that gives S' from S the *blowup of S on D* . Note that the image M of the regular neighborhood of ∂D in $S - \text{int}D$ by the blowup of S on D is a crosscap, where a crosscap is a Möbius band in the interior of a surface. Conversely, the *blowdown of S' on M* is the following manipulation that gives S from S' . We paste a disk on the boundary obtained by cutting S along the center line μ of M . The blowdown of S' on M is the inverse manipulation of the blowup of S on D .

Let x_0 be a point of N_{g-1} and let $e : D' \hookrightarrow N_{g-1}$ be a smooth embedding of a unit disk $D' \subset \mathbb{C}$ to N_{g-1} such that the interior of $D := e(D')$ contains x_0 . Let $\mathcal{M}(N_{g-1}, x_0)$ be the group of isotopy classes of self-diffeomorphisms on N_{g-1} fixing the point x_0 , where isotopies also fix x_0 . Then we have the *blowup homomorphism*

$$\varphi : \mathcal{M}(N_{g-1}, x_0) \rightarrow \mathcal{M}(N_g)$$

that is defined as follows. For $h \in \mathcal{M}(N_{g-1}, x_0)$, we take a representative h' of h which satisfies either of the following conditions: (a) $h'|_D$ is the identity map on D , (b) $h'(x) = e(e^{-1}(x))$ for $x \in D$. Such h' is compatible with the blowup of N_{g-1} on D , thus $\varphi(h) \in \mathcal{M}(N_g)$ is induced and well defined (c.f. [11, Subsection 2.3]).

The *point pushing map*

$$j : \pi_1(N_{g-1}, x_0) \rightarrow \mathcal{M}(N_{g-1}, x_0)$$

is a homomorphism that is defined as follows. For $\gamma \in \pi_1(N_{g-1}, x_0)$, $j(\gamma) \in \mathcal{M}(N_{g-1}, x_0)$ is described as the result of pushing the point x_0 once along γ . Note that for $x, y \in \pi_1(N_{g-1})$, yx means $yx(t) = x(2t)$ for $0 \leq t \leq \frac{1}{2}$ and $yx(t) = y(2t - 1)$ for $\frac{1}{2} \leq t \leq 1$, and for elements $[f], [g]$ of the mapping class group, $[f][g]$ means $[f \circ g]$.

We define the *crosscap pushing map* as the composition of homomorphisms:

$$\psi := \varphi \circ j : \pi_1(N_{g-1}, x_0) \rightarrow \mathcal{M}(N_g).$$

For $\gamma \in \pi_1(N_{g-1}, x_0)$, we also call $\psi(\gamma)$ the *crosscap pushing map along γ* . Remark that for $\gamma, \gamma' \in \pi_1(N_{g-1}, x_0)$, $\psi(\gamma)\psi(\gamma') = \psi(\gamma\gamma')$. The next two lemmas follow from the description of the point pushing map (see [6, Lemma 2.2, Lemma 2.3]).

Lemma 2.1. *For a two-sided simple loop γ on N_{g-1} based at x_0 , suppose that γ_1, γ_2 are two-sided simple closed curves on N_{g-1} such that $\gamma_1 \sqcup \gamma_2$ is the boundary of the regular neighborhood N of γ in N_{g-1} whose interior contains D . Then for some orientation of N , we have*

$$\psi(\gamma) = \varphi(t_{\gamma_1}t_{\gamma_2}^{-1}) = t_{\tilde{\gamma}_1}t_{\tilde{\gamma}_2}^{-1},$$

where $\tilde{\gamma}_1, \tilde{\gamma}_2$ are images of γ_1, γ_2 to N_g by blowups respectively (see Figure 3).

Let μ be a one-sided simple closed curve and let α be a two-sided simple closed curve on N_g such that μ and α intersect transversely at one point. For these simple closed curves μ and α , we denote by $Y_{\mu,\alpha}$ a self-diffeomorphism on N_g which is described as the result of pushing the regular neighborhood of μ once along α . We call $Y_{\mu,\alpha}$ a *Y-homeomorphism* (or *crosscap slide*). By Lemma 3.6 in [11], Y-homeomorphisms are in $\Gamma_2(N_g)$.

Lemma 2.2. *Suppose that γ is a one-sided simple loop on N_{g-1} based at x_0 such that γ and ∂D intersect at antipodal points of ∂D . Then we have*

$$\psi(\gamma) = Y_{\mu,\tilde{\gamma}},$$

where $\tilde{\gamma}$ is a image of γ to N_g by a blowup and μ is a center line of the crosscap obtained from the regular neighborhood of ∂D in N_{g-1} by the blowup of N_{g-1} on D (see Figure 4).

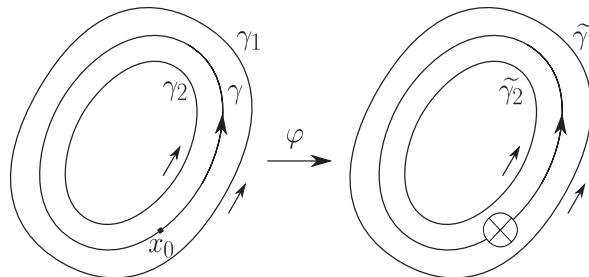

FIG. 3. A crosscap pushing map along two-sided simple loop γ .

Remark that the image of a crosscap pushing map is contained in $\Gamma_2(N_g)$. By Lemma 2.1,

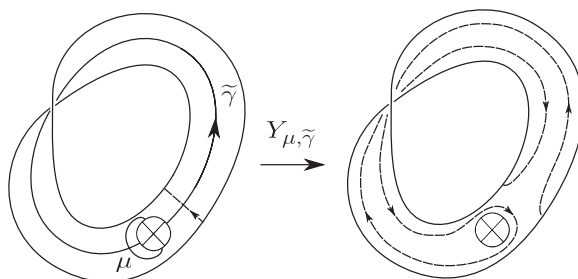

FIG. 4. A crosscap pushing map along one-sided simple loop γ (Y-homeomorphism $Y_{\mu, \tilde{\gamma}}$).

if γ is a two-sided simple loop on N_g , then $\psi(\gamma)$ is an element of $\mathcal{T}_2(N_g)$. We remark that Y-homeomorphisms are not in $\mathcal{T}(N_g)$ (see [7]).

2.2. Notation of the surface N_g . Let $e_i : D'_i \hookrightarrow \Sigma_0$ for $i = 1, 2, \dots, g$ be smooth embeddings of unit disks $D'_i \subset \mathbb{C}$ to a 2-sphere Σ_0 such that $D_i := e_i(D'_i)$ and D_j are disjoint for distinct $1 \leq i, j \leq g$, and let $x_i \in \Sigma_0$ for $i = 1, 2, \dots, g$ be g points of Σ_0 such that x_i is contained in the interior of D_i as the left-hand side of Figure 5. Then N_g is diffeomorphic to the surface obtained from Σ_0 by the blowups on D_1, \dots, D_g . We describe the identification of ∂D_i by the x-mark as the right-hand side of Figure 5. We call the crosscap which is obtained from the regular neighborhood of ∂D_i in Σ_0 by the blowup of Σ_0 on D_i the i -th crosscap.

We denote by $N_{g-1}^{(k)}$ the surface obtained from Σ_0 by the blowups on D_i for every $i \neq k$. $N_{g-1}^{(k)}$ is diffeomorphic to N_{g-1} . Let $x_{k;i}$ be a simple loop on N_g based at x_k for $i \neq k$ as Figure 6. Then the fundamental group $\pi_1(N_{g-1}^{(k)}) = \pi_1(N_{g-1}^{(k)}, x_k)$ of $N_{g-1}^{(k)}$ has the following presentation.

$$\pi_1(N_{g-1}^{(k)}) = \langle x_{k;1}, \dots, x_{k;k-1}, x_{k;k+1}, \dots, x_{k;g} \mid x_{k;1}^2 \cdots x_{k;k-1}^2 x_{k;k+1}^2 \cdots x_{k;g}^2 = 1 \rangle.$$

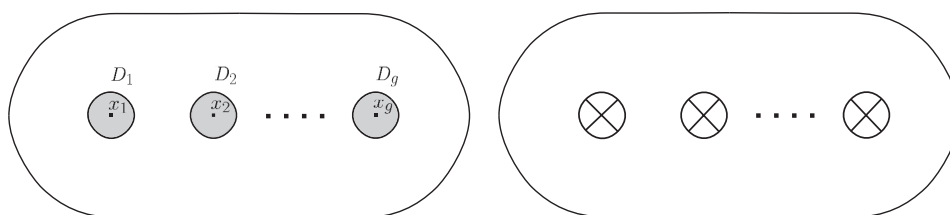

FIG.5. The embedded disks D_1, D_2, \dots, D_g on Σ_0 and the surface N_g .

2.3. Notations of mapping classes. Let $\psi_k : \pi_1(N_{g-1}^{(k)}) \rightarrow \mathcal{M}(N_g)$ be the crosscap pushing map obtained from the blowup of $N_{g-1}^{(k)}$ on D_k and let $\pi_1(N_{g-1}^{(k)})^+$ be the subgroup of $\pi_1(N_{g-1}^{(k)})$ generated by two-sided simple loops on $N_{g-1}^{(k)}$ based at x_k . By Lemma 2.1, we have $\psi_k(\pi_1(N_{g-1}^{(k)})^+) \subset \mathcal{T}_2(N_g)$. We define non-separating two-sided simple loops $\alpha_{k;i,j}$ and $\beta_{k;i,j}$ on $N_{g-1}^{(k)}$ based at x_k as in Figure 7 for distinct $1 \leq i < j \leq g$ and $1 \leq k \leq g$. We also define $\alpha_{k;j,i} := \alpha_{k;i,j}$ and $\beta_{k;j,i} := \beta_{k;i,j}$ for distinct $1 \leq i < j \leq g$ and $1 \leq k \leq g$. We have the following equations:

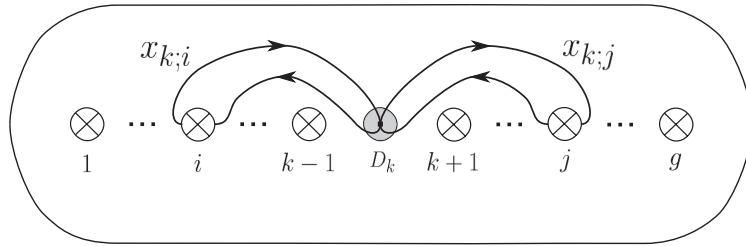

FIG. 6. The simple loop $x_{k,i}$ for $1 \leq i \leq k - 1$ and $x_{k,j}$ for $k + 1 \leq j \leq g$ on $N_{g-1}^{(k)}$ based at x_k .

$$\begin{aligned} \alpha_{k;i,j} &= x_{k,i}x_{k;j} && \text{for } i < j < k \text{ or } j < k < i \text{ or } k < i < j, \\ \beta_{k;i,j} &= x_{k;j}x_{k;i} && \text{for } i < j < k \text{ or } j < k < i \text{ or } k < i < j. \end{aligned}$$

Denote the crosscap pushing maps $a_{k;i,j} := \psi_k(\alpha_{k;i,j})$ and $b_{k;i,j} := \psi_k(\beta_{k;i,j})$. Remark that $a_{k;i,j}$ and $b_{k;i,j}$ are contained in the image of $\psi_k|_{\pi_1(N_{g-1}^{(k)})^+}$. Let η be the self-diffeomorphism on N_g which is the rotation of N_g such that η sends the i -th crosscap to the $(i + 1)$ -st crosscap for $1 \leq i \leq g - 1$ and the g -th crosscap to the 1-st crosscap as Figure 8. Then we have $a_{k;i,j} = \eta^{k-1} a_{1;i-k+1,j-k+1} \eta^{-(k-1)}$ and $b_{k;i,j} = \eta^{k-1} b_{1;i-k+1,j-k+1} \eta^{-(k-1)}$ for each distinct $1 \leq i, j, k \leq g$.

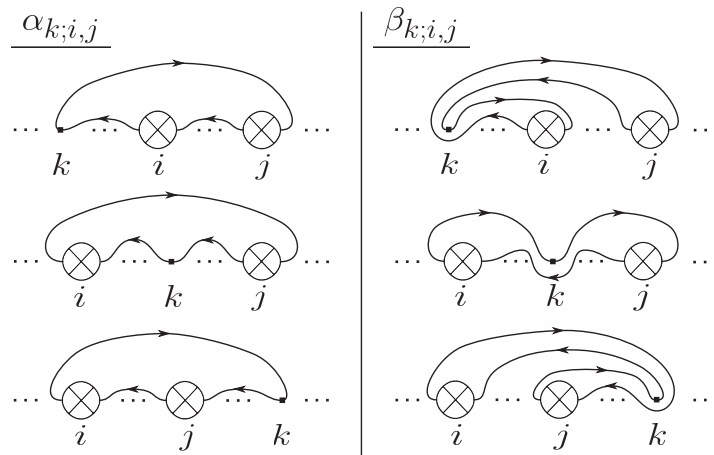

FIG. 7. Two-sided simple loops $\alpha_{k;i,j}$ and $\beta_{k;i,j}$ on $N_{g-1}^{(k)}$ based at x_k .

For distinct $i_1, i_2, \dots, i_n \in \{1, 2, \dots, g\}$, we define a simple closed curve $\alpha_{i_1, i_2, \dots, i_n}$ on N_g as in Figure 9. The arrow on the side of the simple closed curve $\alpha_{i_1, i_2, \dots, i_n}$ in Figure 9 indicates the direction of the Dehn twist $t_{\alpha_{i_1, i_2, \dots, i_n}}$ along $\alpha_{i_1, i_2, \dots, i_n}$ if n is even. We set the notations of Dehn twists and Y-homeomorphisms as follows:

$$\begin{aligned} T_{i,j} &:= t_{\alpha_{i,j}} && \text{for } 1 \leq i < j \leq g, \\ T_{i,j,k,l} &:= t_{\alpha_{i,j,k,l}} && \text{for } g \geq 4 \text{ and } 1 \leq i < j < k < l \leq g, \\ Y_{i,j} &:= Y_{\alpha_i, \alpha_j} = \psi_i(x_{i,j}) && \text{for distinct } 1 \leq i, j \leq g. \end{aligned}$$

Note that $T_{i,j}^2$ and $T_{i,j,k,l}^2$ are elements of $\mathcal{T}_2(N_g)$, $Y_{i,j}$ is an element of $\Gamma_2(N_g)$ but $Y_{i,j}$ is not an

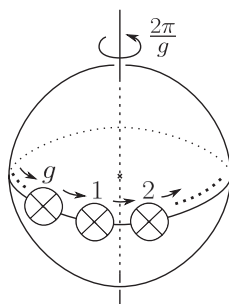

FIG. 8. The self-diffeomorphism η on N_g .

element of $\mathcal{T}_2(N_g)$. We remark that $a_{k;i,j} = b_{k;i,j}^{-1} = T_{i,j}^2$ for any distinct $i, j, k \in \{1, 2, 3\}$ when $g = 3$.

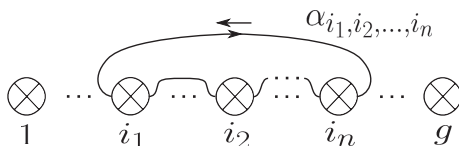

FIG. 9. The simple closed curve $\alpha_{i_1, i_2, \dots, i_n}$ on N_g .

3. Finite generating set for $\mathcal{T}_2(N_g)$

In this section, we prove the main theorem in this paper. The main theorem is as follows:

Theorem 3.1. For $g \geq 3$, $\mathcal{T}_2(N_g)$ is generated by the following elements:

- (i) $a_{k;i,i+1}, b_{k;i,i+1}, a_{k;k-1,k+1}, b_{k;k-1,k+1}$ for $1 \leq k \leq g, 1 \leq i \leq g$ and $i \neq k - 1, k$,
- (ii) $a_{1;2,4}, b_{k;1,4}, a_{l;1,3}$ for $k = 2, 3$ and $4 \leq l \leq g$ when g is odd,
- (iii) $T_{1,j,k,l}^2$ for $2 \leq j < k < l \leq g$ when $g \geq 4$,

where the indices are considered modulo g .

We remark that the number of generators in Theorem 3.1 is $\frac{1}{6}(g^3 + 6g^2 + 5g - 6)$ for $g \geq 4$ odd, $\frac{1}{6}(g^3 + 6g^2 - g - 6)$ for $g \geq 4$ even and 3 for $g = 3$.

3.1. Finite generating set for $\pi_1(N_{g-1}^{(k)})^+$. First, we have the following lemma:

Lemma 3.2. For $g \geq 2$, $\pi_1(N_{g-1}^{(k)})^+$ is an index 2 subgroup of $\pi_1(N_{g-1}^{(k)})$.

Proof. Note that $\pi_1(N_{g-1}^{(k)})$ is generated by $x_{k;1}, \dots, x_{k;k-1}, x_{k;k+1}, \dots, x_{k;g}$. If $g = 2$, $\pi_1(N_{g-1}^{(k)})$ is isomorphic to \mathbb{Z}_2 which is generated by a one-sided simple loop. Hence $\pi_1(N_{g-1}^{(k)})^+$ is trivial and we obtain this lemma when $g = 2$.

We assume that $g \geq 3$. For $i \neq k$, we have

$$x_{k;i} = x_{k;k-1}^{-1} \cdot x_{k;k-1} x_{k;i}.$$

Since $x_{k;k-1} x_{k;i} = \beta_{k;i,k-1} \in \pi_1(N_{g-1}^{(k)})^+$, the equivalence classes of $x_{k;i}$ and $x_{k;k-1}^{-1}$ in $\pi_1(N_{g-1}^{(k)}) / \pi_1(N_{g-1}^{(k)})^+$ are the same. We also have

$$x_{k;k-1} = x_{k;k-1}^{-1} \cdot x_{k;k-1}^2.$$

Since $x_{k;k-1}^2 \in \pi_1(N_{g-1}^{(k)})^+$, the equivalence classes of $x_{k;k-1}$ and $x_{k;k-1}^{-1}$ in $\pi_1(N_{g-1}^{(k)})/\pi_1(N_{g-1}^{(k)})^+$ are the same. Thus $\pi_1(N_{g-1}^{(k)})/\pi_1(N_{g-1}^{(k)})^+$ is generated by the equivalence class $[x_{k;k-1}]$ whose order is 2 and we have completed the proof of Lemma 3.2. \square

$N_{g-1}^{(k)}$ is diffeomorphic to the surface on the left-hand side (resp. right-hand side) of Figure 10 when $g - 1 = 2h + 1$ (resp. $g - 1 = 2h + 2$). We take a diffeomorphism which sends $x_{k;i}$ for $i \neq k$ and x_k as in Figure 6 to $x_{k;i}$ for $i \neq k$ and x_k as in Figure 10 and identify $N_{g-1}^{(k)}$ with the surface in Figure 10 by the diffeomorphism. Denote by $p_k : \widetilde{N_{g-1}^{(k)}} \rightarrow N_{g-1}^{(k)}$ the orientation double covering of $N_{g-1}^{(k)}$ as in Figure 11. Then $H_k := (p_k)_*(\pi_1(\widetilde{N_{g-1}^{(k)}}))$ is an index 2 subgroup of $\pi_1(N_{g-1}^{(k)})$. Note that when $g - 1 = 2h + 1$, $\pi_1(\widetilde{N_{g-1}^{(k)}})$ is generated by $y_{k;i}$ for $1 \leq i \leq 4h$, and when $g - 1 = 2h + 2$, $\pi_1(\widetilde{N_{g-1}^{(k)}})$ is generated by $y_{k;i}$ for $1 \leq i \leq 4h + 2$, where $y_{k;i}$ is two-sided simple loops on $\widetilde{N_{g-1}^{(k)}}$ based at the lift \tilde{x}_k of x_k as in Figure 11. We have the following Lemma.

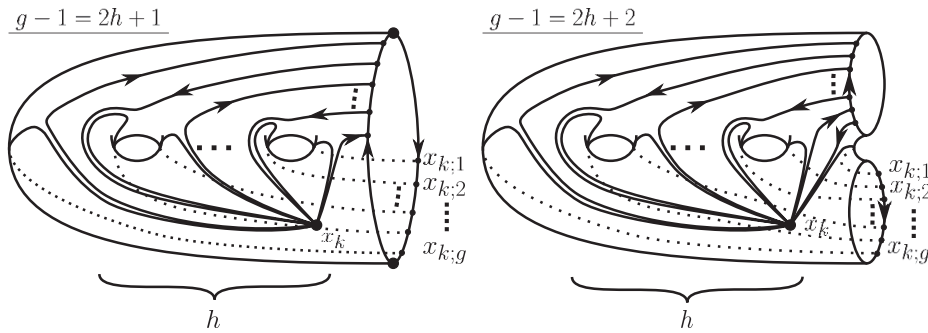

FIG. 10. $N_{g-1}^{(k)}$ is diffeomorphic to the surface on the left-hand side (resp. right-hand side) of the figure when $g - 1 = 2h + 1$ (resp. $g - 1 = 2h + 2$). We regard the above surface on the left-hand side as the surface identified antipodal points of the boundary component, and the above surface on the right-hand side as the surface attached their boundary components along the orientation of the boundary.

Lemma 3.3. For $g - 1 \geq 1$ and $1 \leq k \leq g$,

$$H_k = \pi_1(N_{g-1}^{(k)})^+.$$

Proof. Note that $\pi_1(N_{g-1}^{(k)})^+$ is an index 2 subgroup of $\pi_1(N_{g-1}^{(k)})$ by Lemma 3.2. It is sufficient for proof of Lemma 3.3 to prove $H_k \subset \pi_1(N_{g-1}^{(k)})^+$ because the index of H_k in $\pi_1(N_{g-1}^{(k)})$ is

$$\begin{aligned} 2 &= [\pi_1(N_{g-1}^{(k)}) : H_k] = [\pi_1(N_{g-1}^{(k)}) : \pi_1(N_{g-1}^{(k)})^+][\pi_1(N_{g-1}^{(k)})^+ : H_k] \\ &= 2 \cdot [\pi_1(N_{g-1}^{(k)})^+ : H_k] \end{aligned}$$

if $H_k \subset \pi_1(N_{g-1}^{(k)})^+$.

We define subsets of $\pi_1(N_{g-1}^{(k)})^+$ as follows:

$$\begin{aligned} A &:= \{x_{k;j+1}x_{k;j}, x_{k;k+1}x_{k;k-1} \mid 1 \leq j \leq g-1, j \neq k-1, k\}, \\ B &:= \{x_{k;j}x_{k;j+1}, x_{k;k-1}x_{k;k+1} \mid 1 \leq j \leq g-1, j \neq k-1, k\}, \\ C &:= \begin{cases} \{x_{k;1}^2\} & \text{if } k \neq 1, \\ \{x_{k;2}^2\} & \text{if } k = 1. \end{cases} \end{aligned}$$

$\pi_1(\widetilde{N_{g-1}^{(k)}})$ is generated by $y_{k;i}$. For $i \leq 2h$ when $g-1 = 2h+1$ (resp. $i \leq 2h+1$ when $g-1 = 2h+2$), we can check that

$$(p_k)_*(y_{k;i}) = \begin{cases} x_{k;\rho(i+1)}x_{k;\rho(i)} & \text{if } 2 \leq i \leq 2h \text{ and } g-1 = 2h+1, \\ x_{k;g}x_{k;g-1} & \text{if } i = 1 \text{ and } g-1 = 2h+1, \\ x_{k;\rho(i+1)}x_{k;\rho(i)} & \text{if } 2 \leq i \leq 2h+1 \text{ and } g-1 = 2h+2, \\ x_{k;g}x_{k;g-1} & \text{if } i = 1 \text{ and } g-1 = 2h+2, \end{cases}$$

and $(p_k)_*(y_{k;i})$ is an element of A , where ρ is the order reversing bijection from $\{1, 2, \dots, 2h\}$ (resp. $\{1, 2, \dots, 2h+1\}$) to $\{1, 2, \dots, g-1\} - \{k\}$. Since if $g-1 = 2h+1$ and $g-1 = 2h'+2$, we have

$$\begin{aligned} (p_k)_*(y_{k;2h+1}) &= \begin{cases} x_{k;1}^2 & \text{if } k \neq 1, \\ x_{k;2}^2 & \text{if } k = 1, \end{cases} \\ (p_k)_*(y_{k;2h'+2}) &= \begin{cases} x_{k;1}^2 & \text{if } k \neq 1, \\ x_{k;2}^2 & \text{if } k = 1, \end{cases} \end{aligned}$$

$(p_k)_*(y_{k;2h+1})$ and $(p_k)_*(y_{k;2h'+2})$ are elements of C respectively (see Figure 12). Finally, for $i \geq 2h+2$ when $g-1 = 2h+1$ (resp. $i \geq 2h+3$ when $g-1 = 2h+2$), we can also check that

$$(p_k)_*(y_{k;i}) = \begin{cases} x_{k;\rho'(i)}x_{k;\rho'(i+1)} & \text{if } 2h+2 \leq i \leq 4h-1 \text{ and } g-1 = 2h+1, \\ x_{k;g-1}x_{k;g} & \text{if } i = 4h \text{ and } g-1 = 2h+1, \\ x_{k;\rho'(i)}x_{k;\rho'(i+1)} & \text{if } 2h+3 \leq i \leq 4h+1 \text{ and } g-1 = 2h+2, \\ x_{k;g-1}x_{k;g} & \text{if } i = 4h+2 \text{ and } g-1 = 2h+2, \end{cases}$$

and $(p_k)_*(y_{k;i}) = x_{k;\rho'(i)}x_{k;\rho'(i+1)}$ is an element of B , where ρ' is the order preserving bijection from $\{2h+2, 2h+3, \dots, 4h\}$ (resp. $\{2h+3, 2h+4, \dots, 4h+2\}$) to $\{1, 2, \dots, g-1\} - \{k\}$ (see Figure 13). We obtain this lemma. □

By the proof of Lemma 3.3, we have the following proposition.

Proposition 3.4. *For $g \geq 2$, $\pi_1(N_{g-1}^{(k)})^+$ is generated by the following elements:*

- (1) $x_{k;i+1}x_{k;i}, x_{k;i}x_{k;i+1}, x_{k;k+1}x_{k;k-1}, x_{k;k-1}x_{k;k+1}$ for $1 \leq i \leq g-1$ and $i \neq k-1, k$,
- (2) $x_{k;2}^2$ when $k = 1$,
- (3) $x_{k,1}^2$ when $2 \leq k \leq g$.

We remark that $x_{k;i+1}x_{k;i} = \beta_{k,i,i+1}, x_{k;i}x_{k;i+1} = \alpha_{k,i,i+1}, x_{k;k+1}x_{k;k-1} = \alpha_{k,k-1,k+1}, x_{k;k-1}x_{k;k+1} = \beta_{k,k-1,k+1}$ and $Y_{i,j}^2 = Y_{j,i}^2$. Let G be the subgroup of $\mathcal{T}_2(N_g)$ generated by $\cup_{k=1}^g \psi_k(\pi_1(N_{g-1}^{(k)})^+)$. The next corollary follows from Proposition 3.4 immediately.

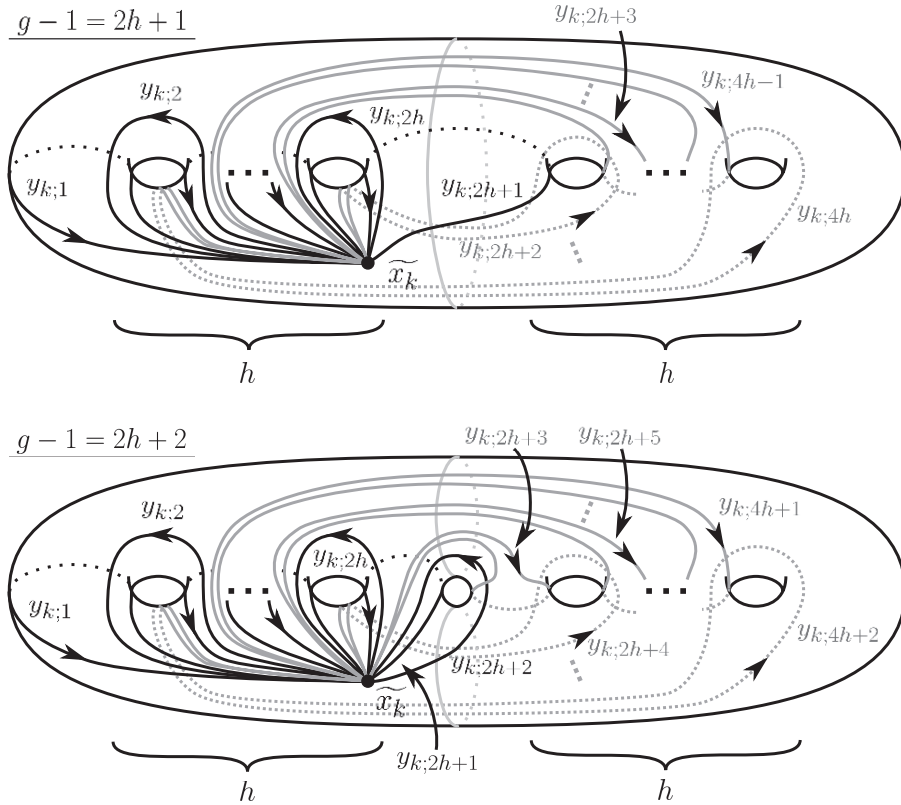

FIG. 11. The total space $\widetilde{N_{g-1}^{(k)}}$ of the orientation double covering p_k of $N_{g-1}^{(k)}$ and two-sided simple loops $y_{k;i}$ on $\widetilde{N_{g-1}^{(k)}}$ based at \tilde{x}_k .

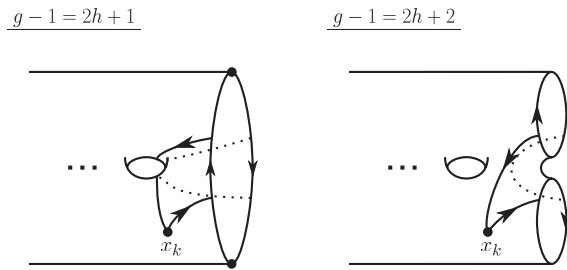

FIG. 12. The representative of $x_{k;1}^2$ when $k \neq 1$ or $x_{k;2}^2$ when $k = 1$.

Corollary 3.5. For $g \geq 2$, G is generated by the following elements:

- (i) $a_{k;i,i+1}, b_{k;i,i+1}, a_{k;k-1,k+1}, b_{k;k-1,k+1}$ for $1 \leq k \leq g, 1 \leq i \leq g-1$ and $i \neq k-1, k$,
- (ii) $Y_{1,j}^2$ when $2 \leq j \leq g$,

where the indices are considered modulo g .

The simple loop $x_{k;1}^2$ and $x_{k;2}^2$ are separating loops. By the next proposition, $\pi_1(N_{g-1}^{(k)})^+$ is generated by finitely many two-sided non-separating simple loops.

Proposition 3.6. For $g \geq 2$, $\pi_1(N_{g-1}^{(k)})^+$ is generated by the following elements:

- (1) $x_{k;i+1}x_{k;i}, x_{k;i}x_{k;i+1}, x_{k;k+1}x_{k;k-1}, x_{k;k-1}x_{k;k+1}$ for $1 \leq i \leq g$ and $i \neq k-1, k$,

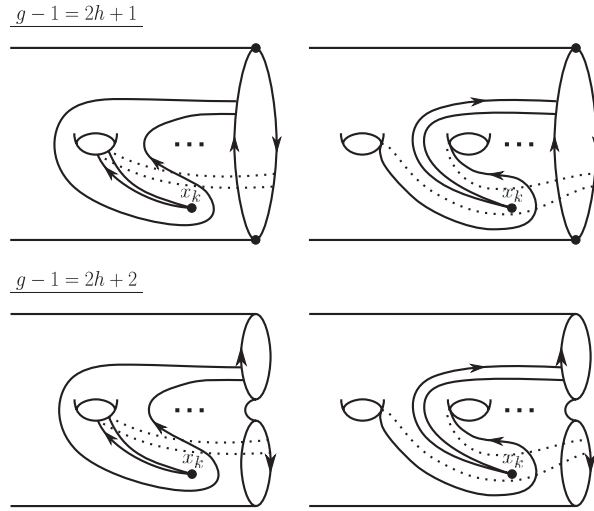

FIG. 13. The representative of $x_{k;j}x_{k;j+1}$ and $x_{k;k-1}x_{k;k+1}$ for $j \neq k-1, k$.

- (2) $x_{k;2}x_{k;4}$ when $k = 1$ and $g-1$ is even,
- (3) $x_{k;1}x_{k;4}$ when $k = 2, 3$ and $g-1$ is even,
- (4) $x_{k;1}x_{k;3}$ when $4 \leq k \leq g$ and $g-1$ is even,

where the indices are considered modulo g .

Proof. When $g-1$ is odd, since we have

$$x_{1;2}^2 = x_{1;2}x_{1;3} \cdot x_{1;3}^{-1}x_{1;4}^{-1} \cdot x_{1;4}x_{1;5} \cdots \cdots x_{1;g-1}^{-1}x_{1;g}^{-1} \cdot x_{1;g}x_{1;2}$$

and

$$x_{k;1}^2 = x_{k;1}x_{k;2} \cdot x_{k;2}^{-1}x_{k;3}^{-1} \cdot x_{k;3}x_{k;4} \cdots \cdots x_{k;g-1}^{-1}x_{k;g}^{-1} \cdot x_{k;g}x_{k;1}$$

for $2 \leq k \leq g$, this proposition is clear.

When $g-1$ is even, we use the relation

$$x_{k;1}^2 \cdots x_{k;k-1}^2 x_{k;k+1}^2 \cdots x_{k;g}^2 = 1.$$

For $k = 1$, we have

$$x_{1;2}^2 = x_{1;2}x_{1;4} \cdot x_{1;4}x_{1;5} \cdots \cdots x_{1;g}x_{1;2} \cdot x_{1;2}x_{1;3} \cdot x_{1;3}x_{1;2}.$$

By a similar argument, we also have following equations:

$$x_{k;1}^2 = \begin{cases} x_{2;1}^2 = x_{2;1}x_{2;4} \cdot x_{2;4}x_{2;5} \cdots \cdots x_{2;g}x_{2;1} \cdot x_{2;1}x_{2;3} \cdot x_{2;3}x_{2;1} & \text{if } k = 2, \\ x_{3;1}^2 = x_{3;1}x_{3;4} \cdot x_{3;4}x_{3;5} \cdots \cdots x_{3;g}x_{3;1} \cdot x_{3;1}x_{3;2} \cdot x_{3;2}x_{3;1} & \text{if } k = 3, \\ x_{k;1}^2 = x_{k;1}x_{k;3} \cdot x_{k;3}x_{k;4} \cdots \cdots x_{k;k-1}x_{k;k+1} \cdots \cdots \\ \quad \cdot x_{k;g}x_{k;1} \cdot x_{k;1}x_{k;2} \cdot x_{k;2}x_{k;1} & \text{if } 4 \leq k \leq g. \end{cases}$$

We obtain this proposition. □

We remark that $x_{k;1}x_{k;g} = \beta_{k;1,g}$, $x_{k;g}x_{k;1} = \alpha_{k;1,g}$, $x_{1;2}x_{1;4} = \alpha_{1;2,4}$, $x_{k;1}x_{k;4} = \beta_{k;1,4}$ for $k = 2, 3$ and $x_{k;1}x_{k;3} = \alpha_{k;1,3}$ for $4 \leq k \leq g$. By the above remarks, we have the following

corollary.

Corollary 3.7. *For $g \geq 2$, G is generated by the following elements:*

- (i) $a_{k;i,i+1}, b_{k;i,i+1}, a_{k;k-1,k+1}, b_{k;k-1,k+1}$ for $1 \leq k \leq g, 1 \leq i \leq g$ and $i \neq k - 1, k$,
- (ii) $a_{1;2,4}, b_{k;1,4}, a_{l;1,3}$ for $k = 2, 3$ and $4 \leq l \leq g$ when g is odd,

where the indices are considered modulo g .

3.2. Proof of Main-Theorem. First, we obtain a finite generating set for $\mathcal{T}_2(N_g)$ by the Reidemeister-Schreier method. We use the following minimal generating set for $\Gamma_2(N_g)$ given by Hirose and Sato [2] when $g \geq 5$ and Szepietowski [12] when $g = 3, 4$ to apply the Reidemeister-Schreier method. See for instance [4] to recall the Reidemeister-Schreier method.

Theorem 3.8. [2, 12] *For $g \geq 3$, $\Gamma_2(N_g)$ is generated by the following elements:*

- (1) $Y_{i,j}$ for $1 \leq i \leq g - 1, 1 \leq j \leq g$ and $i \neq j$,
- (2) $T_{1,j,k,l}^2$ for $2 \leq j < k < l \leq g$ when $g \geq 4$.

Proposition 3.9. *For $g \geq 3$, $\mathcal{T}_2(N_g)$ is generated by the following elements:*

- (1) $Y_{i,j}Y_{1,2}, Y_{i,j}^2$ for $1 \leq i \leq g - 1, 1 \leq j \leq g$ and $i \neq j$,
- (2) $Y_{1,2}^{-1}T_{1,j,k,l}^2Y_{1,2}, T_{1,j,k,l}^2$ for $2 \leq j < k < l \leq g$ when $g \geq 4$.

Proof. Note that $\mathcal{T}_2(N_g)$ is the intersection of $\Gamma_2(N_g)$ and $\mathcal{T}(N_g)$. Hence we have the isomorphisms

$$\Gamma_2(N_g)/(\Gamma_2(N_g) \cap \mathcal{T}(N_g)) \cong (\Gamma_2(N_g)\mathcal{T}(N_g))/\mathcal{T}(N_g) \cong \mathbb{Z}_2[Y_{1,2}].$$

We remark that $\Gamma_2(N_g)\mathcal{T}(N_g) = \mathcal{M}(N_g)$ and the last isomorphism is given by Lickorish [7]. Thus $\mathcal{T}_2(N_g)$ is an index 2 subgroup of $\Gamma_2(N_g)$.

Set $U := \{Y_{1,2}, 1\}$ and X as the generating set for $\Gamma_2(N_g)$ in Theorem 3.8, where 1 means the identity element. Then U is a Schreier transversal for $\mathcal{T}_2(N_g)$ in $\Gamma_2(N_g)$. For $x \in \Gamma_2(N_g)$, define \bar{x} as the element of U such that $[\bar{x}] = [x]$ in $\Gamma_2(N_g)/\mathcal{T}_2(N_g)$. By the Reidemeister-Schreier method, for $g \geq 4$, $\mathcal{T}_2(N_g)$ is generated by

$$\begin{aligned} B = & \{\overline{wu}^{-1}wu \mid w \in X^\pm, u \in U, wu \notin U\} \\ = & \{\overline{Y_{i,j}^{\pm 1}Y_{1,2}}^{-1} Y_{i,j}^{\pm 1}Y_{1,2}, \overline{Y_{i,j}^{\pm 1}}^{-1} Y_{i,j}^{\pm 1} \mid 1 \leq i \leq g - 1, 1 \leq j \leq g, i \neq j\} \\ & \cup \{\overline{T_{1,j,k,l}^{\pm 2}Y_{1,2}}^{-1} T_{1,j,k,l}^{\pm 2}Y_{1,2}, \overline{T_{1,j,k,l}^{\pm 2}}^{-1} T_{1,j,k,l}^{\pm 2} \mid 2 \leq j < k < l \leq g\} \\ = & \{Y_{i,j}^{\pm 1}Y_{1,2}, Y_{1,2}^{-1}Y_{i,j}^{\pm 1} \mid 1 \leq i \leq g - 1, 1 \leq j \leq g, i \neq j\} \\ & \cup \{Y_{1,2}^{-1}T_{1,j,k,l}^{\pm 2}Y_{1,2}, T_{1,j,k,l}^{\pm 2} \mid 2 \leq j < k < l \leq g\}, \end{aligned}$$

where $X^\pm := X \cup \{x^{-1} \mid x \in X\}$ and note that equivalence classes of Y -homeomorphisms in $\Gamma_2(N_g)/\mathcal{T}_2(N_g)$ is nontrivial. Since $Y_{1,2}^{-1}Y_{i,j}^{\pm 1} = (Y_{i,j}^{\mp 1}Y_{1,2})^{-1}$ and $Y_{i,j}^{-1}Y_{1,2} = Y_{i,j}^{-2} \cdot Y_{i,j}Y_{1,2}$, we have the following generating set for $\mathcal{T}_2(N_g)$:

$$\begin{aligned} B' = & \{Y_{i,j}Y_{1,2}, Y_{i,j}^2 \mid 1 \leq i \leq g - 1, 1 \leq j \leq g, i \neq j\} \\ & \cup \{Y_{1,2}^{-1}T_{1,j,k,l}^2Y_{1,2}, T_{1,j,k,l}^2 \mid 2 \leq j < k < l \leq g\}. \end{aligned}$$

By a similar discussion, $\mathcal{T}_2(N_3)$ is generated by

$$B' = \{Y_{i,j}Y_{1,2}, Y_{i,j}^2 \mid 1 \leq i \leq 2, 1 \leq j \leq 3, i \neq j\}.$$

We obtain this proposition. □

Let \mathcal{G} be the group generated by the elements of type (i), (ii) and (iii) in Theorem 3.1. Then \mathcal{G} is a subgroup of $\mathcal{T}_2(N_g)$ clearly and it is sufficient for the proof of Theorem 3.1 to prove $B' \subset \mathcal{G}$, where B' is the generating set for $\mathcal{T}_2(N_g)$ in the proof of Proposition 3.9. By Corollary 3.7, we have $\psi_k(\pi_1(N_{g-1}^{(k)})^+) \subset \mathcal{G}$ for any $1 \leq k \leq g$. Thus $Y_{i,j}^2 = \psi_i(x_{i,j}^2) \in \psi_i(\pi_1(N_{g-1}^{(i)})^+) \subset \mathcal{G}$. We complete the proof of Theorem 3.1 if $Y_{i,j}Y_{1,2}$ and $Y_{1,2}^{-1}T_{1,j,k,l}^2Y_{1,2}$ are in \mathcal{G} .

Lemma 3.10. For $g \geq 4$, $Y_{1,2}^{-1}T_{1,j,k,l}^2Y_{1,2} \in \mathcal{G}$.

Proof. Since $Y_{1,2}^{-1}T_{1,j,k,l}^2Y_{1,2} = t_{Y_{1,2}^{-1}(\alpha_{1,j,k,l})}$, $Y_{1,2}^{-1}T_{1,j,k,l}^2Y_{1,2}$ is a Dehn twist along the two-sided simple closed curve as in Figure 14. Then we have $a_{1;k,l}(\alpha_{1,2,k,l}) = Y_{1,2}^{-1}(\alpha_{1,2,k,l})$ and $Y_{1,2}^{-2}a_{1;2,j}a_{1;k,l}(\alpha_{1,j,k,l}) = Y_{1,2}^{-1}(\alpha_{1,j,k,l})$ for $3 \leq j \leq g$ and the local orientation of the regular neighborhood of $a_{1;k,l}(\alpha_{1,2,k,l})$ (resp. $Y_{1,2}^{-2}a_{1;2,j}a_{1;k,l}(\alpha_{1,j,k,l})$) and $Y_{1,2}^{-1}(\alpha_{1,2,k,l})$ (resp. $Y_{1,2}^{-1}(\alpha_{1,j,k,l})$) are different. Therefore we have

$$\begin{aligned} Y_{1,2}^{-1}T_{1,2,k,l}^2Y_{1,2} &= a_{1;k,l}T_{1,2,k,l}^{-2}a_{1;k,l}^{-1}, \\ Y_{1,2}^{-1}T_{1,j,k,l}^2Y_{1,2} &= Y_{1,2}^{-2}a_{1;2,j}a_{1;k,l}T_{1,j,k,l}^{-2}a_{1;k,l}^{-1}a_{1;2,j}^{-1}Y_{1,2}^2 \text{ for } 3 \leq j \leq g. \end{aligned}$$

By Corollary 3.7, $a_{1;k,l}, a_{1;2,j} \in \psi_1(\pi_1(N_{g-1}^{(1)})^+) \subset \mathcal{G}$. We obtain this lemma. □

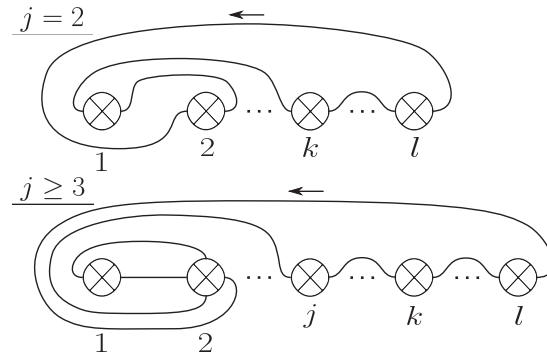

FIG. 14. The upper side of the figure is the simple closed curve $Y_{1,2}^{-1}(\alpha_{1,2,k,l})$ on N_g and the lower side of the figure is the simple closed curve $Y_{1,2}^{-1}(\alpha_{1,j,k,l})$ on N_g for $3 \leq j \leq g$.

Szepietowski [11, Lemma 3.1] showed that for any non-separating two-sided simple closed curve γ , t_γ^2 is a product of two Y-homeomorphisms. In particular, we have the following lemma.

Lemma 3.11 ([11]). For distinct $1 \leq i, j \leq g$,

$$Y_{j,i}^{-1}Y_{i,j} = Y_{j,i}Y_{i,j}^{-1} = \begin{cases} T_{i,j}^2 & \text{for } i < j, \\ T_{i,j}^{-2} & \text{for } j < i. \end{cases}$$

Lemma 3.12. For distinct $1 \leq i, j \leq g$, $T_{i,j}^2 \in \mathcal{G}$.

Proof. We discuss by a similar argument in proof of Lemma 3.5 in [12]. Let γ_i be the two-sided simple loop on $N_{g-1}^{(i)}$ for $i = 3, \dots, g$ as in Figure 15. Then we have $T_{1,2}^2 = \psi_g(\gamma_g) \cdots \psi_4(\gamma_4)\psi_3(\gamma_3)$ (see Figure 15). Since $\gamma_i \in \pi_1(N_{g-1}^{(i)})^+$, each $\psi_i(\gamma_i)$ is an element of \mathcal{G} by Corollary 3.7. Hence we have $T_{1,2}^2 \in \mathcal{G}$.

We denote by $\sigma_{i,j}$ the self-diffeomorphism on N_g which is obtained by the transposition of the i -th crosscap and the j -th crosscap as in Figure 16. $\sigma_{i,j}$ is called the *crosscap transposition* (c.f. [9]). For $1 \leq i < j \leq g$, put $f_{i,j} \in \mathcal{M}(N_g)$ as follows:

$$\begin{aligned} f_{1,2} &:= 1, \\ f_{1,j} &:= \sigma_{j-1,j} \cdots \sigma_{3,4}\sigma_{2,3} \text{ for } 3 \leq j \leq g, \\ f_{i,j} &:= \sigma_{i-1,i} \cdots \sigma_{2,3}\sigma_{1,2}f_{1,j} \text{ for } 2 \leq i < j \leq g. \end{aligned}$$

Then $T_{i,j}^2 = f_{i,j}T_{1,2}^2f_{i,j}^{-1} = f_{i,j}\psi_g(\gamma_g)f_{i,j}^{-1} \cdots f_{i,j}\psi_4(\gamma_4)f_{i,j}^{-1} \cdot f_{i,j}\psi_3(\gamma_3)f_{i,j}^{-1}$. Since the action of $\sigma_{i,j}$ on N_g preserves the set of i -th crosscaps for $1 \leq i \leq g$, $f_{i,j}\psi_k(\gamma_k)f_{i,j}^{-1}$ is an element of $\psi_{k'}(\pi_1(N_{g-1}^{(k')}))$ for some k' . By Corollary 3.7, we have $f_{i,j}\psi_k(\gamma_k)f_{i,j}^{-1} \in \mathcal{G}$ and we obtain this lemma. \square

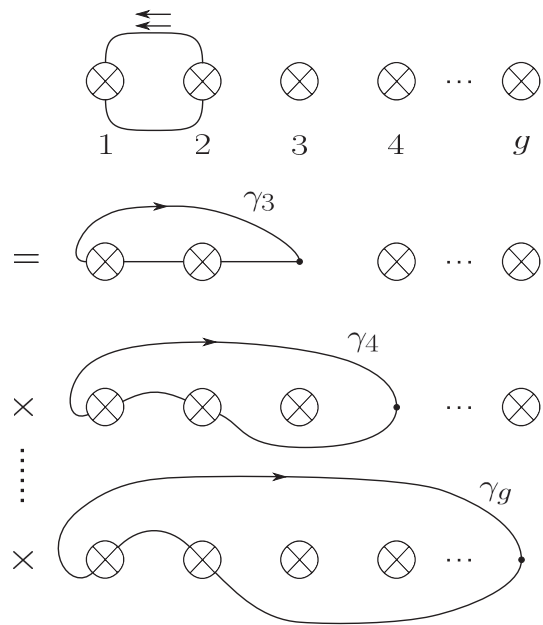

FIG. 15. $T_{1,2}^2$ is a product of crosscap pushing maps along $\gamma_3, \gamma_4, \dots, \gamma_g$.

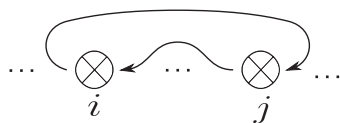

FIG. 16. The crosscap transposition $\sigma_{i,j}$.

Finally, by the following proposition, we complete the proof of Theorem 3.1.

Proposition 3.13. *For distinct $1 \leq i, j, k, l \leq g$, $Y_{k,l}Y_{i,j} \in \mathcal{G}$.*

Proof. $Y_{k,l}Y_{i,j}$ is the following product of elements of \mathcal{G} .

(a) case $(k, l) = (i, j)$:

$$Y_{k,l}Y_{i,j} = Y_{i,j}^2.$$

By Corollary 3.7, the right-hand side is an element of \mathcal{G} .

(b) case $(k, l) = (j, i)$:

$$Y_{j,i}Y_{i,j} = Y_{j,i}^2 \cdot Y_{j,i}^{-1}Y_{i,j} \stackrel{\text{Lem. 3.11}}{=} (a) \cdot T_{i,j}^{\pm 2}.$$

By Lemma 3.12, the right-hand side is an element of \mathcal{G} .

(c) case $k = i$ and $l \neq j$:

$$Y_{i,l}Y_{i,j} = \psi_i(x_{i;l})\psi_i(x_{i;j}) = \psi_i(\alpha_{i;j,l}) = a_{i;j,l} \stackrel{\text{Cor. 3.7}}{\in} \mathcal{G}.$$

(d) case $k \neq i$ and $l = j$:

$$Y_{k,j}Y_{i,j} = Y_{k,j}Y_{k,i} \cdot Y_{k,i}^{-1}Y_{i,k}^{-1} \cdot Y_{i,k}Y_{i,j} = (c) \cdot (b) \cdot (c) \in \mathcal{G}.$$

(e) case $k = j$ and $l \neq i$:

$$Y_{j,l}Y_{i,j} = Y_{j,l}Y_{j,i} \cdot Y_{j,i}^{-1}Y_{i,j} \stackrel{\text{Lem. 3.11}}{=} (c) \cdot T_{i,j}^{\pm 2} \stackrel{\text{Lem. 3.12}}{\in} \mathcal{G}.$$

(f) case $k \neq j$ and $l = i$:

$$Y_{k,i}Y_{i,j} = Y_{k,i}Y_{i,k}^{-1} \cdot Y_{i,k}Y_{i,j} \stackrel{\text{Lem. 3.11}}{=} T_{i,k}^{\pm 2} \cdot (c) \stackrel{\text{Lem. 3.12}}{\in} \mathcal{G}.$$

(g) case $\{k, l\} \cap \{i, j\}$ is empty:

$$Y_{k,l}Y_{i,j} = Y_{k,l}Y_{k,j} \cdot Y_{k,j}^{-1}Y_{k,i}^{-1} \cdot Y_{k,i}Y_{i,j} = (c) \cdot (a) \cdot (d) \in \mathcal{G}.$$

We have completed this proposition. □

By a similar discussion in Subsection 3.2 and Corollary 3.5, we obtain the following theorem.

Theorem 3.14. *For $g \geq 3$, $\mathcal{T}_2(N_g)$ is generated by following elements:*

- (i) $a_{k;i,i+1}, b_{k;i,i+1}, a_{k;k-1,k+1}, b_{k;k-1,k+1}$ for $1 \leq k \leq g, 1 \leq i \leq g-1$ and $i \neq k-1, k$,
- (ii) $Y_{1,j}^2$ for $2 \leq j \leq g$,
- (iii) $T_{1,j,k,l}^2$ for $2 \leq j < k < l \leq g$ when $g \geq 4$,

where the indices are considered modulo g .

Since the number of generators in Theorem 3.14 is $\frac{1}{6}(g^3 + 6g^2 - 7g - 12)$ for $g \geq 4$ and 3 for $g = 3$, the number of generators in Theorem 3.14 is smaller than the number of generators in Theorem 3.1. On the other hand, by Theorem 1.2, the dimension of the first homology group $H_1(\mathcal{T}_2(N_g))$ of $\mathcal{T}_2(N_g)$ is $\binom{g}{3} + \binom{g}{2} - 1 = \frac{1}{6}(g^3 - g - 6)$ for $g \geq 4$. The difference of them is $g^2 - g - 1$. The authors do not know the minimal number of generators for $\mathcal{T}_2(N_g)$ when $g \geq 4$.

4. Normal generating set for $\mathcal{T}_2(N_g)$

The next lemma is a generalization of the argument in the proof of Lemma 3.5 in [12].

Lemma 4.1. *Let γ be a non-separating two-sided simple closed curve on N_g such that $N_g - \gamma$ is a non-orientable surface. Then t_γ^2 is a product of crosscap pushing maps along two-sided non-separating simple loops such that their crosscap pushing maps are conjugate to $a_{1;2,3}$ in $\mathcal{M}(N_g)$.*

Proof of Theorem 1.1. By Theorem 3.1, $\mathcal{T}_2(N_g)$ is generated by (I) crosscap pushing maps along non-separating two-sided simple loops and (II) $T_{1,j,k,l}^2$ for $2 \leq j < k < l \leq g$. When $g = 3$, $\mathcal{T}_2(N_g)$ is generated by $T_{1,2}^2, T_{1,3}^2, T_{2,3}^2$. Recall $T_{i,j}^2 = a_{k;i,j}^{-1}$ when $g = 3$. Since $N_g - \alpha_{i,j}$ is non-orientable for $g \geq 3$, $a_{k;i,j}$ is conjugate to $a_{k';i',j'}$ in $\mathcal{M}(N_g)$. Hence Theorem 1.1 is clear when $g = 3$.

Assume $g \geq 4$. For a non-separating two-sided simple loop c on $N_{g-1}^{(k)}$ based at x_k , by Lemma 2.1, there exist non-separating two-sided simple closed curves c_1 and c_2 such that $\psi(c) = t_{c_1} t_{c_2}^{-1}$, where c_1 and c_2 are images of boundary components of regular neighborhood of c in $N_{g-1}^{(k)}$ to N_g by a blowup. Then the surface obtained by cutting N_g along c_1 and c_2 is diffeomorphic to a disjoint sum of $N_{g-3,2}$ and $N_{1,2}$. Thus mapping classes of type (I) is conjugate to $a_{1;2,3}$ in $\mathcal{M}(N_g)$. We obtain Theorem 1.1 for $g = 4$.

Assume $g \geq 5$. Simple closed curves $\alpha_{i,j,k,l}$ satisfy the condition of Lemma 4.1. Therefore $T_{1,j,k,l}^2$ is a product of crosscap pushing maps along non-separating two-sided simple loops and such crosscap pushing maps are conjugate to $a_{1;2,3}$ in $\mathcal{M}(N_g)$. We have completed the proof of Theorem 1.1. □

5. First homology group of $\mathcal{T}_2(N_g)$

By the argument in the proof of Proposition 3.9, for $g \geq 2$, we have the following exact sequence:

$$(5.1) \quad 1 \longrightarrow \mathcal{T}_2(N_g) \longrightarrow \Gamma_2(N_g) \longrightarrow \mathbb{Z}_2 \longrightarrow 0,$$

where \mathbb{Z}_2 is generated by the equivalence class of a Y-homeomorphism.

The level 2 principal congruence subgroup $\Gamma_2(n)$ of $GL(n, \mathbb{Z})$ is the kernel of the natural surjection $GL(n, \mathbb{Z}) \rightarrow GL(n, \mathbb{Z}_2)$. Szepietowski [12, Corollary 4.2] showed that there exists an isomorphism $\theta : \Gamma_2(N_3) \rightarrow \Gamma_2(2)$ which is induced by the action of $\Gamma_2(N_3)$ on the free part of $H_1(N_3; \mathbb{Z})$. Since the determinant of the action of a Dehn twist on the free part of $H_1(N_3; \mathbb{Z})$ is 1, we have the following commutative diagram of exact sequences:

$$(5.2) \quad \begin{array}{ccccccccc} 1 & \longrightarrow & \mathcal{T}_2(N_3) & \longrightarrow & \Gamma_2(N_3) & \longrightarrow & \mathbb{Z}_2 & \longrightarrow & 1 \\ & & \theta_{|\mathcal{T}_2(N_3)} \downarrow & & \cup & \theta \downarrow & \cup & \downarrow & \\ 1 & \longrightarrow & SL(2, \mathbb{Z})[2] & \longrightarrow & \Gamma_2(2) & \xrightarrow{\det} & \mathbb{Z}_2 & \longrightarrow & 1, \end{array}$$

where $SL(n, \mathbb{Z})[2] := \Gamma_2(n) \cap SL(n, \mathbb{Z})$ is the level 2 principal congruence subgroup of the integral special linear group $SL(n, \mathbb{Z})$. By the commutative diagram (5.2), $\mathcal{T}_2(N_3)$ is isomorphic to $SL(2, \mathbb{Z})[2]$.

Proof of Theorem 1.2. For $g = 3$, the first homology group $H_1(\mathcal{T}_2(N_3))$ is isomorphic

to $H_1(SL(2, \mathbb{Z})[2])$ by the commutative diagram (5.2). The restriction of the natural surjection from $SL(2, \mathbb{Z})$ to the projective special linear group $PSL(2, \mathbb{Z})$ to $SL(n, \mathbb{Z})[2]$ gives the following commutative diagram of exact sequences:

$$(5.3) \quad \begin{array}{ccccccccc} 1 & \longrightarrow & \mathbb{Z}_2[-E] & \longrightarrow & SL(2, \mathbb{Z}) & \longrightarrow & PSL(2, \mathbb{Z}) & \longrightarrow & 1 \\ & & \text{id} \downarrow & & \downarrow & & \downarrow & & \\ & & \mathbb{Z}_2[-E] & \longrightarrow & SL(2, \mathbb{Z})[2] & \longrightarrow & PSL(2, \mathbb{Z})[2] & \longrightarrow & 1 \end{array}$$

where E is the identity matrix and $PSL(n, \mathbb{Z})[2] := SL(n, \mathbb{Z})/\{\pm E\}$ is the level 2 principal congruence subgroup of $PSL(2, \mathbb{Z})$. Since $PSL(2, \mathbb{Z})[2]$ is isomorphic to the free group F_2 of rank 2 and $-E$ commutes with all matrices, the exact sequence in the lower row of Diagram (5.3) is split and $SL(2, \mathbb{Z})[2]$ is isomorphic to $F_2 \oplus \mathbb{Z}_2$. Thus $H_1(\mathcal{T}_2(N_3))$ is isomorphic to $\mathbb{Z}^2 \oplus \mathbb{Z}_2$.

For $g \geq 2$, the exact sequence (5.1) induces the five term exact sequence between these groups:

$$H_2(\Gamma_2(N_g)) \longrightarrow H_2(\mathbb{Z}_2) \longrightarrow H_1(\mathcal{T}_2(N_g))_{\mathbb{Z}_2} \longrightarrow H_1(\Gamma_2(N_g)) \longrightarrow H_1(\mathbb{Z}_2) \longrightarrow 0,$$

where

$$H_1(\mathcal{T}_2(N_g))_{\mathbb{Z}_2} := H_1(\mathcal{T}_2(N_g))/\langle fm - m \mid m \in H_1(\mathcal{T}_2(N_g)), f \in \mathbb{Z}_2 \rangle.$$

For $m \in H_1(\mathcal{T}_2(N_g))$ and $f \in \mathbb{Z}_2$, $fm := [f'm'f'^{-1}] \in H_1(\mathcal{T}_2(N_g))$ for some representative $m' \in \mathcal{T}_2(N_g)$ and $f' \in \Gamma_2(N_g)$. Since $H_2(\mathbb{Z}_2) \cong H_2(\mathbb{R}P^\infty) = 0$ and $H_1(\mathbb{Z}_2) \cong \mathbb{Z}_2$, we have the short exact sequence:

$$0 \longrightarrow H_1(\mathcal{T}_2(N_g))_{\mathbb{Z}_2} \longrightarrow H_1(\Gamma_2(N_g)) \longrightarrow \mathbb{Z}_2 \longrightarrow 0.$$

Since Hirose and Sato [2] showed that $H_1(\Gamma_2(N_g)) \cong \mathbb{Z}_2^{\binom{g}{3} + \binom{g}{2}}$, it is sufficient for the proof of Theorem 1.2 when $g \geq 5$ to prove that the action of $\mathbb{Z}_2 \cong \Gamma_2(N_g)/\mathcal{T}_2(N_g)$ on the set of the first homology classes of generators for $\mathcal{T}_2(N_g)$ is trivial.

By Theorem 1.1, $\mathcal{T}_2(N_g)$ is generated by crosscap pushing maps along non-separating two-sided simple loops for $g \geq 5$. Let $\psi(\gamma) = t_{\gamma_1} t_{\gamma_2}^{-1}$ be a crosscap pushing map along a non-separating two-sided simple loop γ , where γ_1 and γ_2 are images of boundary components of the regular neighborhood of γ in N_{g-1} to N_g by a blowup. The surface S obtained by cutting N_g along γ_1 and γ_2 is diffeomorphic to a disjoint sum of $N_{g-3,2}$ and $N_{1,2}$. Since $g - 3 \geq 5 - 3 = 2$, we can define a Y-homeomorphism Y on the component of S . The Y-homeomorphism is not a product of Dehn twists. Hence $[Y]$ is the nontrivial element in \mathbb{Z}_2 and clearly $Y\psi(\gamma)Y^{-1} = \psi(\gamma)$ in $\Gamma_2(N_g)$, i.e. $[Y\psi(\gamma)Y^{-1}] = [\psi(\gamma)]$ in $H_1(\mathcal{T}_2(N_g))$. Therefore the action of \mathbb{Z}_2 on $H_1(\mathcal{T}_2(N_g))$ is trivial and we have completed the proof of Theorem 1.2. \square

REMARK 5.1. When $g = 3$, we have the exact sequence

$$0 \longrightarrow H_1(\mathcal{T}_2(N_3))_{\mathbb{Z}_2} \longrightarrow H_1(\Gamma_2(N_3)) \longrightarrow \mathbb{Z}_2 \longrightarrow 0$$

by the argument in the proof of Theorem 1.2. Since $H_1(\Gamma_2(N_3)) \cong H_1(\Gamma_2(2)) \cong \mathbb{Z}_2^4$, we showed that the action of $\mathbb{Z}_2 \cong \Gamma_2(N_3)/\mathcal{T}_2(N_3)$ on $H_1(\mathcal{T}_2(N_3))$ is not trivial by Theorem 1.2

when $g = 3$.

ACKNOWLEDGEMENTS. The authors would like to express their gratitude to Hisaaki Endo and Susumu Hirose, for their encouragement and helpful advices. The authors also wish to thank Masatoshi Sato for his comments and helpful advices. The second author was supported by JSPS KAKENHI Grant number 15J10066.

References

- [1] D.R.J. Chillingworth: *A finite set of generators for the homeotopy group of a non-orientable surface*, Math. Proc. Cambridge Philos. Soc. **65** (1969), 409–430.
- [2] S. Hirose and M. Sato: *A minimal generating set of the level 2 mapping class group of a non-orientable surface*, Math. Proc. Cambridge Philos. Soc. **157** (2014), 345–355.
- [3] S.P. Humphries: *Normal closures of powers of Dehn twists in mapping class groups*, Glasgow Math. J. **34** (1992), 313–317.
- [4] D.L. Johnson: *Presentations of Groups*, London Math. Soc. Stud. Texts **15** (1990).
- [5] M. Korkmaz: *First homology group of mapping class group of nonorientable surfaces*, Math. Proc. Cambridge Phil. Soc. **123** (1998), 487–499.
- [6] M. Korkmaz: *Mapping class groups of nonorientable surfaces*, Geom. Dedicata **89** (2002), 109–133.
- [7] W.B.R. Lickorish: *On the homeomorphisms of a non-orientable surface*, Math. Proc. Cambridge Philos. Soc. **61** (1965), 61–64.
- [8] J.D. McCarthy and U. Pinkall: *Representing homology automorphisms of nonorientable surfaces*, Max Planck Inst. Preprint MPI/SFB 85-11, revised version written on 26 Feb 2004, available from <http://www.math.msu.edu/~mccarthy/publications/selected.papers.html>.
- [9] L. Paris and B. Szepietowski: *A presentation for the mapping class group of a nonorientable surface*, arXiv:1308.5856v1 [math.GT], 2013.
- [10] M. Stukow: *The twist subgroup of the mapping class group of a nonorientable surface*, Osaka J. Math. **46** (2009), 717–738.
- [11] B. Szepietowski: *Crosscap slides and the level 2 mapping class group of a nonorientable surface*, Geom. Dedicata **160** (2012), 169–183.
- [12] B. Szepietowski: *A finite generating set for the level 2 mapping class group of a nonorientable surface*, Kodai Math. J. **36** (2013), 1–14.

Ryoma Kobayashi
 Department of General Education
 Ishikawa National College of Technology
 Tsubata, Ishikawa 929–0392
 Japan
 e-mail: kobayashi_ryoma@ishikawa-nct.ac.jp

Genki Omori
 Department of Mathematics
 Tokyo Institute of Technology
 Oh-okayama, Meguro
 Tokyo 152-8551
 Japan
 e-mail: omori.g.aa@m.titech.ac.jp