

THE FORCING PARTIAL ORDER ON A FAMILY OF BRAIDS FORCED BY PSEUDO-ANOSOV 3-BRAIDS

EIKO KIN

(Received May 22, 2006, revised August 10, 2007)

Abstract

Li-York theorem tells us that a period 3 orbit for a continuous map of the interval into itself implies the existence of a periodic orbit of every period. This paper concerns an analogue of the theorem for homeomorphisms of the 2-dimensional disk. In this case a periodic orbit is specified by a braid type and on the set of all braid types Boyland's dynamical partial order can be defined. We describe the partial order on a family of braids and show that a period 3 orbit of pseudo-Anosov braid type implies the Smale-horseshoe map which is a factor possessing complicated chaotic dynamics.

1. Introduction

Let $f: D \rightarrow D$ be an orientation preserving homeomorphism of the 2-dimensional closed disk D . One of the main question on dynamical systems is to investigate the variety of periodic orbits. Suppose that there exists a periodic orbit, say P . In this setting we concern the question to find more periodic orbits other than P by using the notion of the braid type [5]. Let D_n be the n -punctured disk, where n is a period of P . Take an arbitrary orientation preserving homeomorphism $j: D \setminus P \rightarrow D_n$ and consider the composition $\hat{f} = j \circ f|_{D \setminus P} \circ j^{-1}: D_n \rightarrow D_n$. Let $[\hat{f}]$ be the isotopy class of \hat{f} . The *braid type of P for f* , denoted by $bt(P, f)$, is the conjugacy class of $[\hat{f}]$ in the mapping class group $MCG(D_n)$ of D_n .

By Nielsen-Thurston theory any homeomorphism of D_n is isotopic to either periodic, reducible or pseudo-Anosov map. Since the statement is invariant under conjugacy, it makes sense to speak of the periodic, reducible, pseudo-Anosov braid type. The theory detects the complicated dynamics from the existence of periodic orbits of pseudo-Anosov braid type. For example if $bt(P, f)$ is pseudo-Anosov there exists an infinitely many number of periodic orbits with distinct periods for f . Moreover the logarithm of the dilatation of $bt(P, f)$ gives the lower bound of the topological entropy for f [8, Exposé 10]. Recently it has been recognized that such complexity realizes global and efficient particle mixings in fluid dynamics [6, 13].

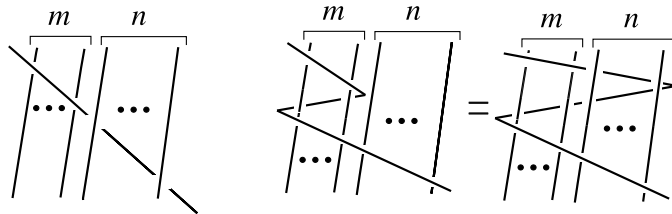

Fig. 1. Braids $\beta_{m,n}$ (left) and $\sigma_{m,n}$ (right).

Our interest is to show which braid types are forced by a given periodic orbit. For the study we use the language of the forcing relation on braid types. We denote the set of braid types of all periodic orbits for f by $bt(f)$. Let BT_n be the set of braid types of period n orbits for all homeomorphisms of D , and $BT = \{\beta \in BT_n \mid n \geq 1\}$. For an element $mc \in MCG(D_n)$, $[mc]$ denotes its conjugacy class. Following [11] we say that $f: D \rightarrow D$ exhibits $[mc] \in BT_n$ if there exists a periodic n orbit for f whose braid type is $[mc]$. We say that $[mc_1] \in BT$ forces $[mc_2] \in BT$, denoted by $[mc_1] \succeq [mc_2]$ provided that if a homeomorphism $f: D \rightarrow D$ exhibits $[mc_1]$, then f also exhibits $[mc_2]$. This relation \succeq is a partial order on BT [5, 16], and it is called the forcing relation or forcing partial order.

Let $[mc_1], [mc_2] \in BT$, and suppose that $[mc_1]$ is pseudo-Anosov. Results by Asimov-Franks [2] and Hall [9] give a strategy to determine whether $[mc_1]$ forces $[mc_2]$ or not. It holds that $[mc_1] \succeq [mc_2]$ if and only if the pseudo-Anosov map $\Phi_{mc_1} \in mc_1$ (which is thought as a homeomorphism of D) exhibits $[mc_2]$.

For the study of braid types it is convenient to use geometric braids. There is a surjective homomorphism Γ from the n -braid group B_n to $MCG(D_n)$. We write $\sigma_i, i = 1, \dots, n - 1$ for the Artin generators of B_n . Any braid type is written by $[\Gamma(b)]$ for some braid $b \in B_n$. Simply we write $[b]$ for $[\Gamma(b)] \in BT_n$ when there is no confusion.

This paper concerns the forcing partial order on the sets of braid types $\{\{\beta_{m,n}\}_{m,n \geq 1}\}$ and $\{\{\sigma_{m,n}\}_{m,n \geq 1}\}$ defined as follows. For any positive integers m and n , let $\beta_{m,n}$ and $\sigma_{m,n}$ be the $(m + n + 1)$ -braids as in Fig. 1. The braid $\sigma_{m,n}$ can be written as $\sigma_{m,n} = \beta_{m,n}\xi$, where $\xi = \sigma_{m+n} \cdots \sigma_2\sigma_1\sigma_1\sigma_2 \cdots \sigma_{m+n}$ (Fig. 1 (right)). Each $\beta_{m,n}$ is pseudo-Anosov, and $\sigma_{m,n}$ is pseudo-Anosov if and only if $|m - n| \geq 2$. These braids are concerned in [12] from view point of braids with small dilatation.

The following is the main result of this paper:

Theorem 1.1. For any $m, n \geq 1$ we have:

- (1) $[\beta_{m,n}] \succeq [\beta_{m+1,n}]$ and $[\beta_{m,n}] \succeq [\beta_{m,n+1}]$,
- (2) $[\beta_{m,n}] \succeq [\sigma_{m,l}]$ if $l \geq m + 2$, and
- (3) $[\sigma_{m,n}] \succeq [\sigma_{m,l}]$ if $n \geq l \geq m + 2$.

In particular fixing $m \geq 1$, the relation \succeq becomes a total order on each set of braid types $\{\{\beta_{m,n}\}_{n \geq 1}\}$, $\{\{\beta_{n,m}\}_{n \geq 1}\}$ and $\{\{\sigma_{m,n}\}_{n \geq m+2}\}$.

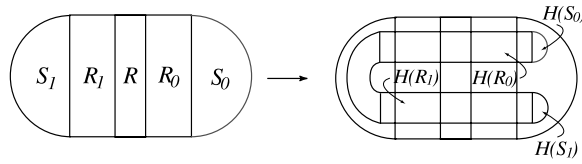

Fig. 2. Smale-horseshoe map H .

Horseshoe braid types are those that can be realized by the periodic orbits for the Smale-horseshoe map $H: D \rightarrow D$ (Fig. 2). This map is known to be a simple factor possessing complicated dynamics. The following theorem says that $[\beta_{1,k}]$ forces any horseshoe braid type:

Theorem 1.2. *We have $[\beta_{1,k}] \succeq [mc]$ for any $k \geq 1$ and any horseshoe braid type $[mc]$.*

Kolev shows that if f has a period 3 orbit P whose braid type is pseudo-Anosov, f has a periodic orbit of every period [14]. This is a best possible analogous result of the Li-York theorem [15] (or the special case of the Sharkovskii theorem), although the theorem does not say which braid types can be realized by the period 3 orbit. Note that the braid type for a fixed point or a period 2 orbit is unique. A question is which braid type for a period n orbit ($n \geq 4$) is forced by a period 3 orbit of pseudo-Anosov type. Theorems 1.1 and 1.2 together with a Handel’s result [11] gives an answer:

Corollary 1.3. *Let $f: D \rightarrow D$ be an orientation preserving homeomorphism. Suppose that f has a period 3 orbit whose braid type is pseudo-Anosov. Then we have:*

- (1) $bt(f) \supset \{[\beta_{m,n}] \mid m, n \geq 1\}$, and
- (2) $bt(f) \supset bt(H) \supset \{[\sigma_{m,n}] \mid n \geq m + 2\}$.

2. Preliminaries

In Section 2.1 we review the classification theorem of surface homeomorphisms by Nielsen-Thurston and a result on the relation between the forcing partial order and the dilatation of braids by Los. Section 2.2 introduces a fibered surface for a given graph, and it describes a criterion for determining whether a braid b is pseudo-Anosov or not by Bestvina-Handel. Under the assumption that g is the induced graph map for a braid b satisfying the Bestvina-Handel’s condition, in Section 2.3 we define the reduced graph map g^{red} , and we give a relation between periodic orbits for the thick graph map associated to g^{red} and those for the pseudo-Anosov map $\Phi_b \in \Gamma(b)$. Section 2.4 explains the dynamics on the Smale-horseshoe map can be described by the shift map on the symbol space, and it shows that the braids $\sigma_{m,n}$ ($n \geq m + 2$) arise as braid types of periodic orbits.

2.1. Pseudo-Anosov braids. We introduces three kinds of homeomorphisms. A homeomorphism $\Phi: D_n \rightarrow D_n$ is:

- *periodic* if some power of Φ is the identity map.
- *reducible* if there is a Φ -invariant closed 1-submanifold whose complementary components in D_n have negative Euler characteristic.
- *pseudo-Anosov* if there is a constant $\lambda > 1$ and a pair of transverse measured foliations (\mathcal{F}^s, μ^s) and (\mathcal{F}^u, μ^u) such that $\Phi(\mathcal{F}^s, \mu^s) = (\mathcal{F}^s, \lambda^{-1}\mu^s)$ and $\Phi(\mathcal{F}^u, \mu^u) = (\mathcal{F}^u, \lambda\mu^u)$.

\mathcal{F}^s and \mathcal{F}^u are called the *stable* and *unstable foliation* or the *invariant foliations*. They have a finitely many number of singularities, and the set of singularities of \mathcal{F}^s equals that of \mathcal{F}^u . The number $\lambda = \lambda(\Phi) > 1$ is called the *dilatation* for Φ .

We say that $mc \in MCG(D_n)$ is *periodic* (*reducible*, *pseudo-Anosov* resp.) if it contains a periodic map (reducible map, pseudo-Anosov map resp.) as a representative homeomorphism. An element $mc \in MCG(D_n)$ is called *irreducible* if it is not reducible.

Theorem 2.1 ([8]). *Any irreducible element $mc \in MCG(D_n)$ is periodic or pseudo-Anosov. If mc is pseudo-Anosov, then the pseudo-Anosov map of mc is unique up to conjugacy.*

The Nielsen-Thurston type (i.e., periodic, reducible, pseudo-Anosov) for mc is invariant under conjugacy. When mc is pseudo-Anosov, the *dilatation* $\lambda(mc)$ for mc is defined by $\lambda(\Phi_{mc})$ for the pseudo-Anosov map $\Phi_{mc} \in mc$. This number is also invariant under conjugacy.

Let $A_n = \{a_0, \dots, a_{n-1}\}$ be a set of n -points in the interior of D . Suppose that a_0, \dots, a_{n-1} lie on the horizontal line through the center of the disk from the left to the right, and put $D_n = D \setminus A_n$. Let D_i , $i = 0, \dots, n-1$, be the closed disk which contains a_{i-1} and a_i and no other points of A_n . We define a homomorphism $\Gamma: B_n \rightarrow MCG(D_n)$ as follows: For the Artin generators σ_i , $i = 1, \dots, n-1$, $\Gamma(\sigma_i)$ is represented by a homeomorphism of D_n which fixes the exterior of D_i and rotates in the inside of D_i by 180 degrees in the counter-clockwise direction so that a_{i-1} is interchanged with a_i (Fig. 3). The kernel of Γ is the center of B_n which is generated by a full twist braid $(\sigma_1\sigma_2 \cdots \sigma_{n-1})^n$ [4]. We say that a braid $b \in B_n$ is *pseudo-Anosov* (*periodic*, *reducible* resp.) if $\Gamma(b) \in MCG(D_n)$ is pseudo-Anosov (periodic, reducible resp.). We define the *dilatation* $\lambda(b)$ for the pseudo-Anosov braid b by $\lambda(\Gamma(b))$.

Recall that we write $[b]$ for $[\Gamma(b)]$. One of the relation between the forcing partial order and the dilatation is as follows:

Theorem 2.2 ([16]). *Suppose that b_1 and b_2 are pseudo-Anosov braids. If $[b_1] \succeq [b_2]$ with $[b_1] \neq [b_2]$, then $\lambda(b_1) > \lambda(b_2)$.*

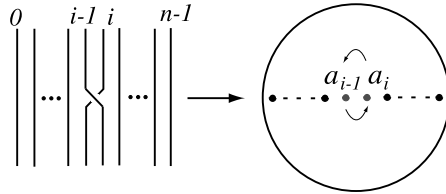

Fig. 3. $\Gamma: B_n \rightarrow MCG(D_n)$.

2.2. Graphs, fibered surfaces and graph maps. Let G be a finite graph embedded on an orientable surface F . In this paper, we assume that an edge of G is closed, and let $\mathcal{E}_{\text{ori}}(G)$ be the set of oriented edges of G , $\mathcal{E}(G)$ the set of unoriented edges, and $\mathcal{V}(G)$ the set of vertices. We denote the oriented edge with the initial vertex v_I and the terminal vertex v_T by $e(v_I, v_T)$. Let \bar{e} be the same edge as e with opposite orientation. A continuous map $g: G \rightarrow G$ is called a *graph map*.

One can associate a *fibered surface* $\mathbb{F}(G) \subset F$ with a projection $\pi: \mathbb{F}(G) \rightarrow G$ (Fig. 4). The fibered surface $\mathbb{F}(G)$ is decomposed into arcs and into polygons modelled on k -junctions, $k \geq 1$. The arcs and the k -junctions are called *decomposition elements*. Under π , the preimage of each vertices of valence k is the k -junction, and the closure of the preimage of each open edge is the strip (fibered by arcs) which is the closure of the one of the complementary components of the union of all junctions.

Recall that $A_n = \{a_0, \dots, a_{n-1}\}$ is a set of n -points in D and $D_n = D \setminus A_n$. In this section we have no assumption on the location of A_n . Let P_i be a small circle centered at a_i such that no other points of A_n is contained in the disk bounded by P_i . We set $P = \bigcup_{i=0}^{n-1} P_i$. Choose a finite graph G embedded on D_n that is homotopy equivalent to D_n such that P is a subgraph of G and G has no vertices of valence 1 or 2.

Let $f: D_n \rightarrow D_n$ be a representative homeomorphism of $\Gamma(b) \in MCG(D_n)$. A fibered surface $\mathbb{F}(G)$ carries f if f maps each decomposition element of $\mathbb{F}(G)$ into a decomposition element and each junction into a junction. When $\mathbb{F}(G)$ carries f , f induces a piecewise linear graph map $g = g_f: G \rightarrow G$ which represents the correspondence of vertices and edge paths determined by f . (Thus g sends vertices to vertices and each edge to an edge path.) We may assume that P is invariant under g without loss of generality.

Suppose that a fibered surface $\mathbb{F}(G)$ carries $f: D_n \rightarrow D_n$ of $\Gamma(b)$ with the induced graph map $g: G \rightarrow G$. In this case we say that g is the *induced graph map for b* . Let $\text{pre}P$ be the set of edges $e \in \mathcal{E}(G)$ such that $g^k(e)$ is contained in P for some $k \geq 1$. The graph map g defines a square and non negative integral matrix called the *transition matrix* T_g^{tot} whose (i, j) -th entry is given by the number of times that the image of the

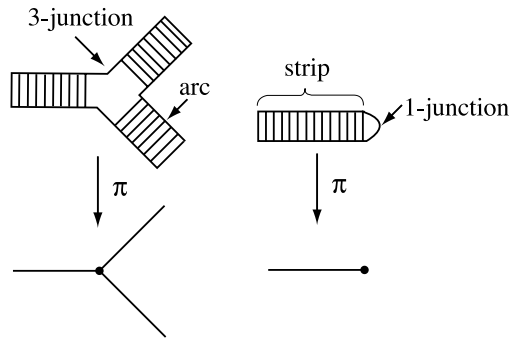

Fig. 4. Fibered surface.

j -th edge of $\mathcal{E}(G)$ under \mathfrak{g} passes through the i -th edge of $\mathcal{E}(G)$. Then $\mathcal{T}_{\mathfrak{g}}^{\text{tot}}$ is of the form

$$\mathcal{T}_{\mathfrak{g}}^{\text{tot}} = \begin{pmatrix} \mathcal{P} & \mathcal{A} & \mathcal{B} \\ 0 & \mathcal{Z} & \mathcal{C} \\ 0 & 0 & \mathcal{T} \end{pmatrix},$$

where \mathcal{P} and \mathcal{Z} are the transition matrices associated to P and $\text{pre}P$ respectively, and \mathcal{T} is the transition matrix associated to the rest of edges called *real edges*. The matrix \mathcal{T} is called the *transition matrix with respect to the real edges*. The spectral radius of \mathcal{T} is denoted by $\lambda(\mathcal{T})$.

A graph map $\mathfrak{g}: G \rightarrow G$ is *efficient* if for any $e \in \mathcal{E}_{\text{ori}}(G)$ and any $k \geq 0$, $\mathfrak{g}^k(e) = e_{k,1}e_{k,2} \cdots e_{k,j}$ satisfies $\overline{e_{k,i}} \neq e_{k,i+1}$ for all $i = 1, \dots, j - 1$.

A non negative square matrix M is *irreducible* if for every set of indices i, j , there is a positive integer $n_{i,j}$ such that the (i, j) -th entry of $M^{n_{i,j}}$ is strictly positive.

Theorem 2.3 ([3]). *Let $b \in B_n$ and let $\mathfrak{g}: G \rightarrow G$ the induced graph map for b . Suppose that*

(BH:1) \mathfrak{g} is efficient, and

(BH:2) the transition matrix \mathcal{T} with respect to the real edges is irreducible with $\lambda(\mathcal{T}) > 1$.

Then b is pseudo-Anosov with dilatation $\lambda(\mathcal{T})$.

An idea of the proof is as follows. The *train track* $\tau \subset D_n$ associated to \mathfrak{g} is obtained by the “smoothing” of G , and as a result the *train track map* $\mathfrak{g}_{\tau}: \tau \rightarrow \tau$ can be defined. If $\mathfrak{g}: G \rightarrow G$ satisfies (BH:1) and (BH:2), one can construct the pseudo-Anosov map $\Phi_b \in \Gamma(b)$ explicitly by using \mathfrak{g}_{τ} , and hence b is pseudo-Anosov. For more details see [3, Section 3.3].

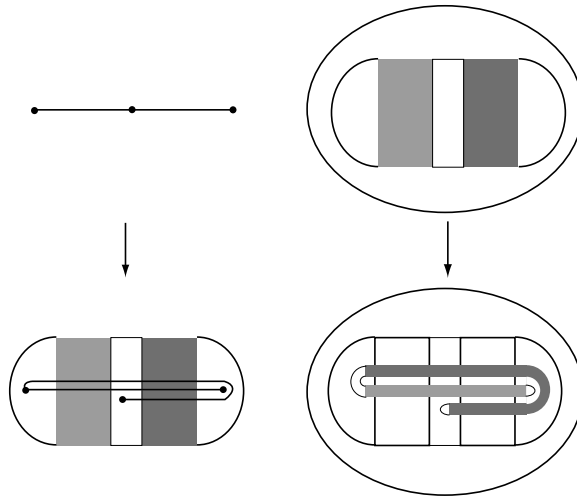

Fig. 5. Embedding (left) and its thick graph map (right).

2.3. Thick graph maps and pseudo-Anosov maps. Let T be a finite tree embedded on D and $\tilde{g}: T \rightarrow \mathbb{F}(T)$ an embedding such that it maps a vertex to a junction and the image of each edge is transverse to arcs of $\mathbb{F}(T)$. A homeomorphism $g: D (\supset \mathbb{F}(T)) \rightarrow D$ is a *thick graph map associated to \tilde{g}* if g satisfies the following conditions:

- g maps each decomposition element of $\mathbb{F}(T)$ into a decomposition element and each junction into a junction.
- g contracts the vertical direction of each strip of $\mathbb{F}(T)$ uniformly and expands the horizontal direction of each strip uniformly.
- $g(\mathbb{F}(T))$ is a fibered surface of the tree $\tilde{g}(T)$.

For example see Fig. 5. Although the thick graph map g is not unique, it is determined uniquely on the invariant set $\Lambda = \bigcap_{j \in \mathbb{Z}} g^j(\mathbb{F}(T))$ under g in a sense of the symbolic dynamics [1].

In the rest of this section, let $g: G \rightarrow G$ be the induced graph map for $b \in B_n$ satisfying (BH:1) and (BH:2). The *reduced graph G^{red}* for G is the tree obtained from G by collapsing each peripheral edge P_i of P to a vertex v_i labeled i . Since P is invariant under g , a piecewise linear graph map $g^{\text{red}}: G^{\text{red}} \rightarrow G^{\text{red}}$, called the *reduced graph map for g* , can be defined such that g^{red} represents the correspondence of vertices and edge paths determined by g , see Fig. 6 (left/center). Because g is the induced graph map for b , $\mathbb{F}(G)$ carries some homeomorphism f of $\Gamma(b)$. Thus $g^{\text{red}}: G^{\text{red}} \rightarrow G^{\text{red}}$ recovers the embedding $\tilde{g}^{\text{red}}: G^{\text{red}} \rightarrow \mathbb{F}(G^{\text{red}})$. The thick graph map $g: D \rightarrow D$ associated to g^{red} means that the one associated to \tilde{g}^{red} .

Assume that the closed braid of b is a knot. Then the thick graph map $g: D \rightarrow D$ associated to g^{red} has a period n orbit, say $P_n = \{p_0, \dots, p_{n-1}\}$ such that a point p_i

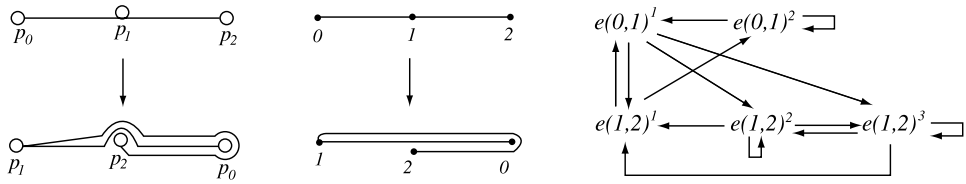

Fig. 6. Induced graph map for $\sigma_1\sigma_2^{-1}$ (left), its reduced graph map (center) and transition graph (right).

is in a junction $\pi^{-1}(v_i)$. Notice that the braid type of P_n for g is $[b]$. We call P_n the *representative orbit* for g (associated to g^{red}).

Results by Asimov-Franks and Hall tell us that

$$bt(\Phi_b) = \{[b'] \in BT \mid [b] \succeq [b']\}.$$

Hence we have $bt(g) \supset bt(\Phi_b)$ since $[b] \in bt(g)$. To give elements of $bt(g)$ which belong to $bt(\Phi_b)$, we introduce terminology. A periodic point $x \in G^{\text{red}}$ for g^{red} is called *regular* if $x \notin \mathcal{V}(G^{\text{red}})$. Since $g^{\text{red}}(\mathcal{V}(G^{\text{red}})) \subset \mathcal{V}(G^{\text{red}})$, if x is regular, $(g^{\text{red}})^i(x)$ is also regular for each $i \geq 0$. Hence it makes sense to speak of the regular periodic orbit. Since the number of the element of $\mathcal{V}(G^{\text{red}})$ is finite, it is easy to check that a given periodic orbit is regular or not.

Next we define a subdivision G_s^{red} of G^{red} as follows: Let e be an edge of $\mathcal{E}(G^{\text{red}})$ such that the edge path $g^{\text{red}}(e)$ is given by $f_1 f_2 \cdots f_k$, $f_i \in \mathcal{E}(G^{\text{red}})$. Subdivide e into subedges e^1, e^2, \dots, e^k so that $g^{\text{red}}(e^i) = f_i$, $i = 1, \dots, k$. (Thus $g^{\text{red}}(e^1 e^2 \cdots e^k) = f_1 f_2 \cdots f_k$ as an edge path.) Let $E_1, \dots, E_l \in \mathcal{E}(G_s^{\text{red}})$ be all edges of G_s^{red} . The *transition graph* Ξ_g is the oriented graph with vertices E_1, \dots, E_l and an oriented edge from E_i to E_j if $g^{\text{red}}(E_i)$ passes through E_j . Note that from the definition of the subdivision, $g^{\text{red}}(E_i)$ passes through E_j at most one times. For example consider the reduced graph map given in Fig. 6 (center), and in this case $e(0, 1)$ is subdivided into $e(0, 1)^1$ and $e(0, 1)^2$, and $e(1, 2)$ is subdivided into $e(1, 2)^1, e(1, 2)^2$ and $e(1, 2)^3$. Since

$$g^{\text{red}}(e(0, 1)) = g^{\text{red}}(e(0, 1)^1 e(0, 1)^2) = e(2, 1)e(1, 0)$$

and

$$g^{\text{red}}(e(1, 2)) = g^{\text{red}}(e(1, 2)^1 e(1, 2)^2 e(1, 2)^3) = e(0, 1)e(1, 2)e(2, 1),$$

we have the transition graph shown in Fig. 6 (right).

Each closed path of Ξ_g gives a periodic orbit for the thick graph map g associated to g^{red} .

Lemma 2.4. *Let $E_0 \rightarrow \dots \rightarrow E_{s-1} \rightarrow E_0$, $E_i \in \mathcal{V}(\Xi_g)$ be a closed path of Ξ_g . Then*

- (1) *there exists a periodic point $x_0 \in E_0$ for g^{red} such that $(g^{\text{red}})^s(x_0) = x_0$ and $x_i = (g^{\text{red}})^i(x_0) \in E_i$ for each $i \in \{0, \dots, s-1\}$, and*
- (2) *there exists a periodic point $\hat{x}_0 \in \pi^{-1}(E_0)$ for g associated to g^{red} such that $g^s(\hat{x}_0) = \hat{x}_0$ and $\hat{x}_i = g^i(\hat{x}_0) \in \pi^{-1}(E_i)$ for each $i \in \{0, \dots, s-1\}$.*

Proof. This can be shown by the symbolic dynamics (for example see [1]). □

The word $E_0E_1 \dots E_{s-1} (\pi^{-1}(E_0) \dots \pi^{-1}(E_{s-1}))$ resp.) in Lemma 2.4 is said to be the *itinerary* of x_0 (\hat{x}_0 resp.).

The symbol $\mathcal{O}_f(x)$ denotes the periodic orbit for a periodic point x for a map f . Since Φ_b (and also Markov partition of Φ_b) is constructed via $g: G \rightarrow G$, there is a natural correspondence between periodic orbits for Φ_b and those for g . If x_0 is the periodic point for g^{red} associated with a closed path $E_0 \rightarrow \dots \rightarrow E_{s-1} \rightarrow E_0$ of Ξ_g in the sense of Lemma 2.4, there is a periodic point \tilde{x}_0 for Φ_b such that $(\Phi_b)^s(\tilde{x}_0) = \tilde{x}_0$ and $\tilde{x}_i = (\Phi_b)^i(\tilde{x}_0)$ is in a *Markov box* labeled E_i for each $i \in \{0, \dots, s-1\}$. If x_0 is regular, then the periodic orbit of \tilde{x}_0 lie on the regular (non-singular) leaves of the stable and unstable foliations for Φ_b . Then the construction of two maps Φ_b and g implies that $bt(\mathcal{O}_{\Phi_b}(\tilde{x}_0), \Phi_b) = bt(\mathcal{O}_g(\hat{x}_0), g)$. (In particular, the period of \tilde{x}_0 for Φ_b equals that of \hat{x}_0 for g .) For more details see [3, Section 3.3]. Thus we have:

Lemma 2.5. *In Lemma 2.4 if x_0 is regular, then $bt(\Phi_b) \ni bt(\mathcal{O}_g(\hat{x}_0), g)$, and hence*

$$[b] \succeq bt(\mathcal{O}_g(\hat{x}_0), g).$$

If x_0 is not regular, g has a periodic point x'_0 in the junction $\pi^{-1}(x_0)$. Then $bt(\mathcal{O}_g(x'_0), g) = bt(\mathcal{O}_{\Phi_b}(\tilde{x}_0), \Phi_b)$ from the construction of two maps. However it is not true in general that the period of x'_0 for g equals that of \hat{x}_0 for g . In this case $bt(\mathcal{O}_{\Phi_b}(\tilde{x}_0), \Phi_b) \neq bt(\mathcal{O}_g(\hat{x}_0), g)$.

2.4. Smale-horseshoe map. The Smale-horseshoe map $H: D \rightarrow D$ is a diffeomorphism such that the action of H on three rectangles R_0, R_1 and R and two half disks S_0, S_1 is given in Fig. 2. The restriction $H|_{R_i}$, $i = 0, 1$ is an affine map such that H contracts R_i vertically and stretches horizontally, and $H|_{S_i}$, $i = 0, 1$ is a contraction map.

The set $\Omega = \bigcap_{j \in \mathbb{Z}} H^j(R_0 \cup R_1)$ is invariant under H , and $H|_{\Omega}: \Omega \rightarrow \Omega$ is conjugate to the *shift map* $\sigma: \Sigma_2 = \{0, 1\}^{\mathbb{Z}} \rightarrow \Sigma_2$, where

$$\sigma(***w_{-1} \cdot w_0 w_1 ***) = (**w_{-1} w_0 \cdot w_1 **), \quad w_j \in \{0, 1\}.$$

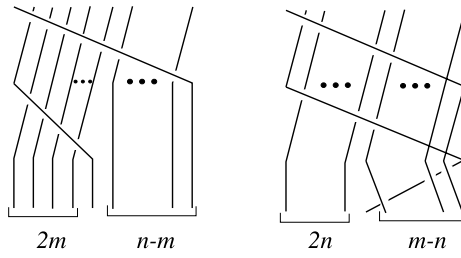

Fig. 7. Braid $\sigma'_{m,n}$: case $n \geq m$ (left), case $m \geq n$ (right).

The conjugacy $\mathcal{K}: \Omega \rightarrow \Sigma_2$ is given by

$$\mathcal{K}(x) = (\cdots \mathcal{K}_{-1}(x)\mathcal{K}_0(x)\mathcal{K}_1(x)\cdots),$$

where

$$\mathcal{K}_j(x) = \begin{cases} 0 & \text{if } H^j(x) \in R_0, \\ 1 & \text{if } H^j(x) \in R_1. \end{cases}$$

If x is a period k point, the word $\mathcal{K}_0(x)\mathcal{K}_1(x)\cdots\mathcal{K}_{k-1}(x)$ is called the *code* for x . Modulo cyclic permutation, $\mathcal{K}_0(x)\mathcal{K}_1(x)\cdots\mathcal{K}_{k-1}(x)$ is said to be the *code* for the periodic orbit $\mathcal{O}_H(x)$. We say that $[b]$, $b \in B_n$ is a *horseshoe braid type* if there is a period n orbit for H whose braid type is $[b]$. For the study of the forcing partial order on the set of horseshoe braid types, see [7, 10].

The argument in [12, Section 3.2] shows that $\sigma_{m,n}$ is conjugate to $\sigma'_{m,n}$ given in Fig. 7. It is not hard to see that when $n \geq m + 2$, $[\sigma'_{m,n}] (= [\sigma_{m,n}])$ is a horseshoe braid type such that the corresponding periodic orbit for H has a code $1 \underbrace{0 \cdots 0}_{n-1} 1 \underbrace{0 \cdots 0}_m$ or $1 \underbrace{0 \cdots 0}_{n-1} 1 \underbrace{0 \cdots 0}_{m-1} 1$. For example $[\sigma'_{1,3}] = [\sigma_1\sigma_2\sigma_3\sigma_4\sigma_1\sigma_2]$ is the horseshoe braid with the code 10010 or 10011.

3. Proof of theorems

Let $g_{m,n}: G_{m,n} \rightarrow G_{m,n}$ be the graph map as in Fig. 8 (left). We label the vertices of $G_{m,n}$ which lie on the peripheral edges, $0, 1, \dots, n + m$ from the right to the left. Other vertices p and q of $G_{m,n}$ have valences $m + 1$ and $n + 1$ respectively. This is the induced graph map for $\beta_{m,n}$ satisfying (BH:1) and (BH:2) ([12]). Hence $\beta_{m,n}$ is pseudo-Anosov for all $m, n \geq 1$. Since $\beta_{m,n}^{-1}$ is conjugate to $\beta_{n,m}$, we have $\lambda(\beta_{m,n}) = \lambda(\beta_{n,m})$. Fig. 8 (right) indicates the transition of peripheral edges.

Now we turn to $\sigma_{m,n}$. For $n \geq m + 2$, let $h_{m,n}: H_{m,n} \rightarrow H_{m,n}$ be the graph map as in Fig. 9 (left). This is the induced graph map for $\sigma'_{m,n}$ in Fig. 7 (left) satisfying (BH:1) and (BH:2) ([12]). Hence $\sigma_{m,n}$ is pseudo-Anosov in this case.

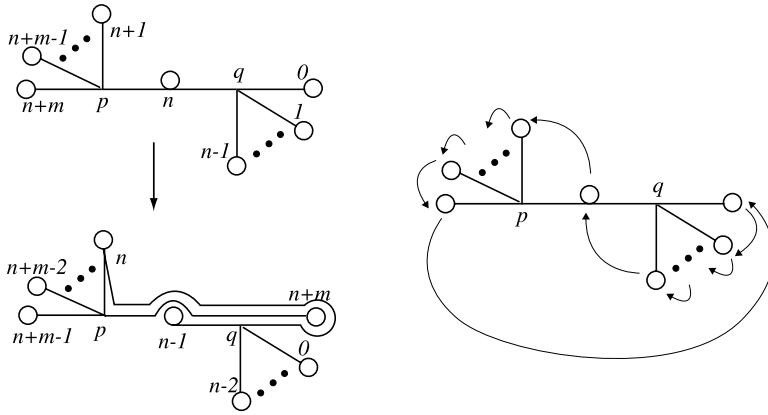

Fig. 8. $g_{m,n}: G_{m,n} \rightarrow G_{m,n}$ (left), transition of peripheral edges (right).

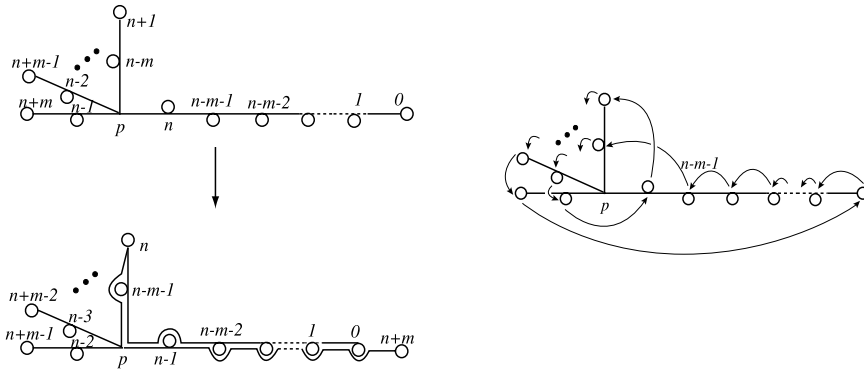

Fig. 9. $h_{m,n}: H_{m,n} \rightarrow H_{m,n}$ (left), transition of peripheral edges (right).

Proof of Theorem 1.1 (1). It is enough to show that $[\beta_{m,n}] \geq [\beta_{m+1,n}]$, for $\beta_{m,n}$ is conjugate to $\beta_{n,m}^{-1}$ and in general $[b] \geq [c]$ if and only if $[b^{-1}] \geq [c^{-1}]$.

We consider the induced graph map $g_{m,n}$ for $\beta_{m,n}$. The transition graph $\Xi_{g_{m,n}}$ has vertices

$$e(q, 0), e(q, 1), \dots, e(q, n - 1), e(q, n)^1, e(q, n)^2, e(q, n)^3, e(q, n)^4, e(q, n)^5, \\ e(p, n), e(p, n + 1), \dots, e(p, n + m - 1), e(p, n + m)^1, e(p, n + m)^2, e(p, n + m)^3.$$

Let $g_{m,n}$ be the thick graph map associated to $g_{m,n}^{\text{red}}$, $P_{m,n}$ the representative orbit for $g_{m,n}$. Note that $bt(P_{m,n}, g_{m,n}) = [\beta_{m,n}]$. We consider the closed path \mathcal{C} of $\Xi_{g_{m,n}}$ of length $m + n + 2$ such that

$$E_0 = e(q, 0) \rightarrow E_1 = e(q, 1) \rightarrow \dots \rightarrow E_{n-1} = e(q, n - 1) \rightarrow E_n = e(q, n)^4 \\ \rightarrow E_{n+1} = e(p, n) \rightarrow E_{n+2} = e(p, n + 1) \rightarrow \dots \rightarrow E_{n+i} = e(p, n + i - 1) \\ \rightarrow \dots \rightarrow E_{n+m} = e(p, n + m - 1) \rightarrow E_{m+n+1} = e(p, n + m)^3 \rightarrow E_0.$$

Take a periodic point $x_0 \in e(q, 0)$ for $g_{m,n}^{\text{red}}$ given in Lemma 2.4. Then $x_n = (g_{m,n}^{\text{red}})^n(x_0) \in E_n = e(q, n)^4$. Since $e(q, n)^4$ is a proper subedge of $e(q, n)$, x_n is regular. Now we claim that the period of the orbit of x_0 is $m + n + 2$. Because $E_i \neq E_j$ ($i \neq j$) in \mathcal{C} , \mathcal{C} is not a repetition of some closed subpath. Since x_n is regular, $x_i \in E_i$ ($0 \leq i \leq m + n + 1$) does not lie on the boundary of E_i . This implies that the length of \mathcal{C} equals the period of x_0 .

By Lemma 2.5 we have $[\beta_{m,n}] \geq bt(\mathcal{O}_{g_{m,n}}(\widehat{x}_0), g_{m,n})$. For the proof of (1), we will show that $[\beta_{m+1,n}] = bt(\mathcal{O}_{g_{m+1,n}}(\widehat{x}_0), g_{m+1,n})$. Now we consider $g_{m+1,n}^{\text{red}}$ and the thick graph map $g_{m+1,n}$ associated to $g_{m+1,n}^{\text{red}}$ with the representative orbit $P_{m+1,n}$. Since $[\beta_{m+1,n}] = bt(P_{m+1,n}, g_{m+1,n})$, it suffices to show that there exists an orientation preserving homeomorphism

$$j : (D, \mathcal{O}_{g_{m,n}}(\widehat{x}_0)) \rightarrow (D, P_{m+1,n})$$

such that $g_{m+1,n} : D \rightarrow D$ is isotopic to $j \circ g_{m,n} \circ j^{-1} : D \rightarrow D$ relative to $P_{m+1,n}$. To do so, we take the tree \widehat{G} embedded on $\mathbb{F}(G_{m,n}^{\text{red}}) \subset D$ (as in Fig. 10 (left)) with the following conditions:

1. $\mathcal{V}(\widehat{G})$ consists of $p, q \in \mathcal{V}(G_{m,n}^{\text{red}})$ and all points of $\mathcal{O}_{g_{m,n}}(\widehat{x}_0)$.
2. The valences of $p, q, \widehat{x}_n \in \mathcal{V}(\widehat{G})$ are $m + 2, n + 1, 2$ respectively, and the other vertices have the valence 1.
3. The $n + 1$ edges emanate from q to each $\widehat{x}_0, \dots, \widehat{x}_n$, and the $m + 2$ edges emanate from p to each $\widehat{x}_n, \dots, \widehat{x}_{m+n+1}$.
4. Each edge of \widehat{G} transverses to each arc of $\mathbb{F}(G_{m,n}^{\text{red}})$.
5. $e(p, \widehat{x}_n)$ is below $e(p, \widehat{x}_{n+1})$ with respect to the vertical coordinate of $\mathbb{F}(G_{m,n}^{\text{red}})$.

We write $P_{m+1,n} = \{p_0, \dots, p_{m+n+1}\}$. Without loss of generality we set

$$\mathcal{V}(G_{m+1,n}^{\text{red}}) = \{p, q, p_0, \dots, p_{m+n+1}\}.$$

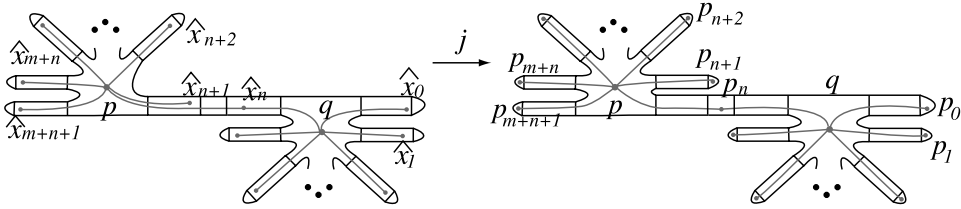

Fig. 10. j sending \hat{G} to $G_{m+1,n}^{\text{red}}$: $\hat{G} \subset \mathbb{F}(G_{m,n}^{\text{red}})$ (left), $G_{m+1,n}^{\text{red}} \subset \mathbb{F}(G_{m+1,n}^{\text{red}})$ (right).

Now we take a homeomorphism $j: D \rightarrow D$ with $j(\hat{G}) = G_{m+1,n}^{\text{red}}$ so that $e(q, \hat{x}_j)$ ($0 \leq j \leq n$) and $e(p, \hat{x}_k)$ ($n \leq k \leq m+n+1$) of \hat{G} map to $e(q, p_j)$ and $e(p, p_k)$ of $G_{m,n}^{\text{red}}$ respectively (Fig. 10). Consider the image of \hat{G} under $g_{m,n}$ and that of $G_{m+1,n}^{\text{red}}$ under $g_{m+1,n}$ (Fig. 11). Then $g_{m+1,n}(G_{m+1,n}^{\text{red}})$ is isotopic to $j \circ g_{m,n} \circ j^{-1}(G_{m+1,n}^{\text{red}})$ relative to $\mathcal{V}(G_{m+1,n}^{\text{red}})$ as union of edges. This means that $g_{m+1,n}: D \rightarrow D$ is isotopic to $j \circ g_{m,n} \circ j^{-1}: D \rightarrow D$ relative to $\mathcal{V}(G_{m+1,n}^{\text{red}})$. In particular $g_{m+1,n}: D \rightarrow D$ is isotopic to $j \circ g_{m,n} \circ j^{-1}$ relative to $P_{m+1,n}$ since $P_{m+1,n} \subset \mathcal{V}(G_{m+1,n}^{\text{red}})$. This completes the proof of (1).

Proof of (2). First we show that $[\beta_{m,n}] \geq [\sigma_{m,m+2}]$. We continue to consider the transition graph $\Xi_{g_{m,n}}$. Let $E_0 = e(q, n)^3$, $E_1 = e(q, n)^5$, $E_2 = e(p, n+1)$, $E_3 = e(p, n+2), \dots, E_m = e(p, n+m-1)$, $E_{m+1}^i = e(p, n+m)^i$, $i = 1, 2$, and $E_{m+2} = e(p, n)$. Take the closed path \mathcal{D}_{m+2} of $\Xi_{g_{m,n}}$ of length $2m+3$ such that

$$E_0 \rightarrow E_1 \rightarrow \dots \rightarrow E_m \rightarrow E_{m+1}^1 \rightarrow E_{m+2} \rightarrow E_2 \rightarrow E_3 \rightarrow \dots \rightarrow E_m \rightarrow E_{m+1}^2 \rightarrow E_0.$$

Let $y_0 \in E_0 = e(q, n)^3$ be a periodic point for $g_{m,n}^{\text{red}}$ given in Lemma 2.4. Since $e(q, n)^3$ is a proper subedge of $e(q, n)$, y_0 is regular. Clearly the period of y_0 equals the length of \mathcal{D}_{m+2} , that is $2m+3$. Fig. 12 indicates the position of the periodic orbit of y_0 .

Let $\mathcal{O}_{g_{m,n}}(\hat{y}_0)$ be the periodic orbit for $g_{m,n}$ associated to $g_{m,n}^{\text{red}}$ given in Lemma 2.4. Recall that $h_{m,m+2}$ is the induced graph map for $\sigma'_{m,m+2}$. Then we see that the braid type of $\mathcal{O}_{g_{m,n}}(\hat{y}_0)$ for $g_{m,n}$ equals the braid type of the representative orbit for the thick graph map associated to $h_{m,m+2}^{\text{red}}$, see Figs. 9 (right) regarding $n = m+2$ and Fig. 12. Hence $br(\mathcal{O}_{g_{m,n}}(\hat{y}_0), g_{m,n}) = [\sigma'_{m,m+2}] = [\sigma_{m,m+2}]$. Since y_0 is regular, we obtain $[\beta_{m,n}] \geq [\sigma_{m,m+2}]$.

We turn to the proof of $[\beta_{m,n}] \geq [\sigma_{m,m+2+l}]$ for any $l \geq 1$. Consider the following closed path \mathcal{D}_{m+2+l} :

$$\underbrace{E_0 \rightarrow E_0 \rightarrow \dots \rightarrow E_0}_{\text{length } l} \rightarrow \underbrace{E_1 \rightarrow \dots \rightarrow E_{m+2} \rightarrow E_2 \rightarrow E_3 \rightarrow \dots \rightarrow E_{m+1}^2 \rightarrow E_0}_{\text{closed path } \mathcal{D}_{m+2}}.$$

This is the concatenation of the l -iterations of $E_0 \rightarrow E_0$ and the closed path \mathcal{D}_{m+2} . By using the same argument as above, one shows that the braid type of the periodic orbit

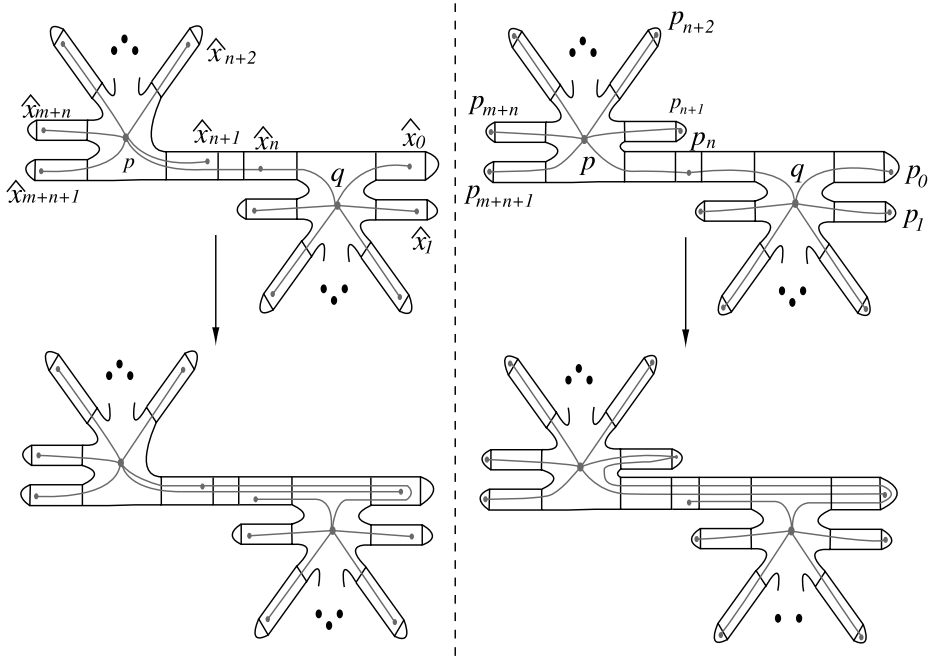

Fig. 11. Image of \hat{G} under $g_{m,n}$ (left), image of $G_{m+1,n}^{\text{red}}$ under $g_{m+1,n}$ (right).

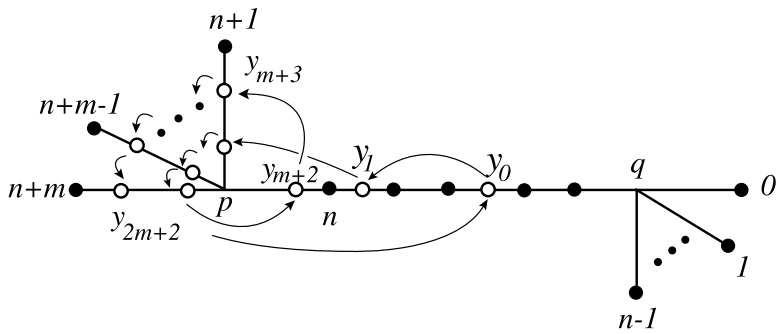

Fig. 12. Symbol \circ indicates the periodic orbit of y_0 , and \bullet is a vertex of $(G_{m,n}^{\text{red}})_s$. Note that $y_0 \in e(q, n)^3$, $y_1 \in e(q, n)^5$.

for $g_{m,n}$ associated to \mathcal{D}_{m+2+l} is $[\sigma_{m,m+2+l}]$, and $[\beta_{m,n}] \succeq [\sigma_{m,m+2+l}]$.

Proof of (3). Theorem 15 (b) in [7] directly shows the claim of (3). □

Proof of Theorem 1.2. Let Q be any periodic orbit in Ω for \mathbb{H} , and let $w_Q = (w_0 w_1 \cdots w_{s-1})$, $w_i \in \{0, 1\}$ the code for Q . We will find a periodic orbit for the thick graph map $g_{1,k}$ associated to $\mathfrak{g}_{1,k}^{\text{red}}$ whose braid type equals $bt(Q, \mathbb{H})$. We denote the edge path $\overline{e(p, k+1)^2 \cdot e(p, k+1)^1 \cdot e(p, k)}$ by E_1 and $\overline{e(q, k)^5 \cdot e(q, k)^4 \cdot e(q, k)^3}$ by E_0 . Then $\mathfrak{g}_{1,k}^{\text{red}}(E_0)$ and $\mathfrak{g}_{1,k}^{\text{red}}(E_1)$ pass through E_i ($i = 0, 1$) one times, see Fig. 8 regarding $m = 1$. These imply that for the code w_Q , there exists a periodic point $z_0 \in E_{w_0}$ for $\mathfrak{g}_{1,k}^{\text{red}}$ and a periodic point $\widehat{z}_0 \in \pi^{-1}(E_{w_0})$ for $g_{1,k}$ such that

$$(\mathfrak{g}_{1,k}^{\text{red}})^s(z_0) = z_0, \quad z_i = (\mathfrak{g}_{1,k}^{\text{red}})^i(z_0) \in E_{w_i}$$

and

$$g_{1,k}^s(\widehat{z}_0) = \widehat{z}_0, \quad \widehat{z}_i = g_{1,k}^i(\widehat{z}_0) \in \pi^{-1}(E_{w_i})$$

for each $i \in \{0, \dots, s-1\}$. It is easy to check that z_0 is regular from the itinerary of z_0 . Note that the restriction map $g_{1,k}|_{\pi^{-1}(E_0) \cup \pi^{-1}(E_1)}$ contracts the vertical direction of the fibered surface uniformly and expands the horizontal direction uniformly. Set

$$\Omega' = \bigcap_{j \in \mathbb{Z}} g_{1,k}^j(\pi^{-1}(E_0) \cup \pi^{-1}(E_1)).$$

Then $g_{1,k}|_{\Omega'}: \Omega' \rightarrow \Omega'$ is conjugate to the shift map $\sigma: \Sigma_2 \rightarrow \Sigma_2$, and hence $g_{1,k}|_{\Omega'}$ is conjugate to $\mathbb{H}|_{\Omega}$. Thus the braid type of a periodic orbit, say P in Ω' for $g_{1,k}$ equals that of the periodic orbit in Ω for \mathbb{H} with the same itinerary as P . In particular, we have $bt(\mathcal{O}_{g_{1,k}}(\widehat{z}_0), g_{1,k}) = bt(Q, \mathbb{H})$. The regularity for z_0 guarantees that $[\beta_{1,k}] \succeq bt(Q, \mathbb{H})$. This completes the proof. □

Proof of Corollary 1.3. By [11, Theorem 0.2], any pseudo-Anosov braid type $[mc] \in BT_3$ forces $[\sigma_1 \sigma_2^{-1}] (= [\beta_{1,1}])$. Since the forcing relation \succeq is a partial order, by Theorem 1.1 (1) we obtain the claim of (1). By Theorem 1.2 we obtain the claim of (2). □

ACKNOWLEDGEMENTS. The author thanks Yoshihiro Yamaguchi and Kiyotaka Tanikawa for giving her a motivation to study families of braids in this paper. The author also thanks Takashi Matsukoka for a great deal of encouragement. The author is partially supported by Grant-in-Aid for Young Scientists (B) (No. 17740094), The Ministry of Education, Culture, Sports, Science and Technology, Japan.

References

- [1] L. Alsedà, J. Llibre and M. Misiurewicz: *Combinatorial Dynamics and Entropy in Dimension One*, second edition, World Sci. Publishing, River Edge, NJ, 2000.
- [2] D. Asimov and J. Franks: *Unremovable closed orbits*; in *Geometric Dynamics* (Rio de Janeiro, 1981), Lecture Notes in Math. **1007**, Springer, Berlin, 1983, 22–29.
- [3] M. Bestvina and M. Handel: *Train-tracks for surface homeomorphisms*, *Topology* **34** (1995), 109–140.
- [4] J.S. Birman: *Braids, Links, and Mapping Class Groups*, *Ann. of Math. Stud.* **82**, Princeton Univ. Press, Princeton, NJ, 1974.
- [5] P. Boyland: *Rotation sets and monotone periodic orbits for annulus homeomorphisms*, *Comment. Math. Helv.* **67** (1992), 203–213.
- [6] P.L. Boyland, H. Aref and M.A. Stremmer: *Topological fluid mechanics of stirring*, *J. Fluid Mech.* **403** (2000), 277–304.
- [7] A. de Carvalho and T. Hall: *Braid forcing and star-shaped train tracks*, *Topology* **43** (2004), 247–287.
- [8] A. Fathi, F. Laudenbach, and V. Poenaru: *Travaux de Thurston sur les Surfaces*, Astérisque **66–67**, Société Mathématique de France, Paris, 1979.
- [9] T. Hall: *Unremovable periodic orbits of homeomorphisms*, *Math. Proc. Cambridge Philos. Soc.* **110** (1991), 523–531.
- [10] T. Hall: *The creation of horseshoes*, *Nonlinearity* **7** (1994), 861–924.
- [11] M. Handel: *The forcing partial order on the three times punctured disk*, *Ergodic Theory Dynam. Systems* **17** (1997), 593–610.
- [12] E. Hironaka and E. Kin: *A family of pseudo-Anosov braids with small dilatation*, *Algebr. Geom. Topol.* **6** (2006), 699–738.
- [13] E. Kin and T. Sakajo: *Efficient topological chaos embedded in the blinking vortex system*, *Chaos* **15** (2005).
- [14] B. Kolev: *Periodic orbits of period 3 in the disc*, *Nonlinearity* **7** (1994), 1067–1071.
- [15] T.Y. Li and J.A. Yorke: *Period three implies chaos*, *Amer. Math. Monthly* **82** (1975), 985–992.
- [16] J. Los: *On the forcing relation for surface homeomorphisms*, *Inst. Hautes Études Sci. Publ. Math.* **85** (1997), 5–61.

Department of Mathematical and Computing Sciences
Tokyo Institute of Technology
Tokyo
Japan
e-mail: kin@is.titech.ac.jp