

ON HANDLE NUMBER OF SEIFERT SURFACES IN S^3

Dedicated to Professor Hideki Ozeki on his sixtieth birthday

HIROSHI GODA

(Received December 12, 1991)

1. Introduction

Let L be an oriented link in S^3 . A *Seifert surface* R for L is a compact oriented surface, without closed components, such that $\partial R=L$. Suppose that the complementary sutured manifold (M, γ) for R (for the definition, see section 4) is irreducible. The *handle number* of R is as follows:

$$h(R) = \min\{h(W); (W, W') \text{ is a Heegaard splitting of } (M; R_+(\gamma), R_-(\gamma))\}.$$

We give the definitions of $h(W)$ and a Heegaard splitting of $(M; R_+(\gamma), R_-(\gamma))$ in section 2 using compression bodies which is introduced by Casson and Gordon in [1].

Note that R is a fiber surface if and only if $h(R)=0$.

In this paper, we completely determine the handle numbers of incompressible Seifert surfaces for prime knots of ≤ 10 crossings. In addition, we show that there is a knot which admits two minimal genus Seifert surfaces whose handle numbers are mutually different (see Example 6.2).

Let R be a Seifert surface in S^3 obtained by a $2n$ -Murasugi sum (for the definition, see section 4) of two Seifert surfaces R_1 and R_2 whose complementary sutured manifolds are irreducible. In [7], we have shown the following two theorems:

Theorem A ([7], Theorem 1).

$$h(R_1)+h(R_2)-(n-1)\leq h(R)\leq h(R_1)+h(R_2).$$

Theorem B ([7], Theorem 2). *If R_1 is a fiber surface, then $h(R)=h(R_2)$.*

And it has been also shown in [7] that the estimation in Theorem A is the best possible.

In this paper, we give a sufficient condition to realize the upper equality $h(R)=h(R_1)+h(R_2)$ of Theorem A in the case of a plumbing (i.e., $n=2$). In fact, we prove:

Theorem 1. *Let R be a Seifert surface in S^3 obtained by a plumbing of two Seifert surfaces R_1 and R_2 whose marked complementary sutured manifolds (M_i, γ_i, A_i) ($i=1, 2$) associated with the plumbing $R=R_1 \cup R_2$ are irreducible. Assume that there is a product disk in M_1 with A_1 as an edge. Then, $h(R)=h(R_1)+h(R_2)$.*

For the definition of a marked sutured manifold, see section 5.

To prove Theorem 1, we consider the cancelling disk pair. Let $(M; N, N')$ be a 3-manifold triad such that N contains no closed surface. Let (W, W') be a Heegaard splitting of $(M; N, N')$ and F a Heegaard surface (for the definition, see section 2). A *cancelling disk pair* is a pair of disks (D, D') with the following condition: $(D, \partial D)$ and $(D', \partial D')$ are disks in $(W, \partial_+ W)$ and $(W', \partial_+ W')$ respectively such that $\partial D \cap \partial D'$ consists of a single point. A *pseudo cancelling disk pair* is a pair of disks (D, D') having the following conditions:

- (1) D is a disk in M such that $\partial D \subset F$ and $N(\partial D, D)$ is contained in W ,
- (2) $(D', \partial D')$ is a disk in $(W', \partial_+ W')$,
- (3) $\partial D \cap \partial D'$ consists of a single point.

Under the above notation, we have:

Proposition 2. *If (W, W') has a pseudo cancelling disk pair, then (W, W') has a cancelling disk pair.*

Note that if M is irreducible then there is a slightly general result in [2] or in [19].

The author wishes to thank Professors Makoto Sakuma and Tsuyoshi Kobayashi for their several conversations. He wants also to thank Professor Kanji Morimoto for his valuable advice.

2. Preliminaries

Throughout this paper, we work in the piecewise linear category, all manifolds including knots, links and Seifert surfaces are oriented, and all submanifolds are in general position unless otherwise specified. For the definitions of standard terms of 3-dimensional topology, knot and link theory, we refer to [9], [10] and [17]. For a topological space B , $\#B$ denotes the number of the components of B . Let H be a subcomplex of a complex K . Then $N(H; K)$ denotes a regular neighborhood of H in K . Let N be a manifold embedded in a manifold M with $\dim N = \dim M$. Then $\text{Fr}_M N$ denotes the frontier of N in M . An arc α properly embedded in a surface S is *inessential* if it is rel ∂ isotopic to an arc in ∂S . If α is not inessential, then it is *essential*. Let $\{\alpha_i\}$ be mutually disjoint essential arcs in S . Then the collection of such arcs is called a *complete system of arcs* for S if the closure of each component of $S - \{\cup \alpha_i\}$ is a disk. Let S be a surface properly embedded in a 3-manifold M . A

disk D^2 in M is a *compressing disk* for S if $D^2 \cap S = \partial D^2$, and ∂D^2 is not contractible in S . If there exists no compressing disk for S , then it is *incompressible*.

A *compression body* W is a cobordism rel ∂ between surfaces $\partial_+ W$ and $\partial_- W$ such that $W \cong \partial_+ W \times I \cup 2\text{-handles} \cup 3\text{-handles}$ and $\partial_- W$ has no 2-sphere components. We can see that if $\partial_- W \neq \emptyset$ and W is connected, W is obtained from $\partial_- W \times I$ by attaching a number of 1-handles along the disks on $\partial_- W \times \{1\}$ where $\partial_- W$ corresponds to $\partial_- W \times \{0\}$. We denote the number of these 1-handles by $h(W)$.

A *defining disk system* \bar{D} for a compression body W is a disjoint union of disks $(D^2, \partial D^2) \subset (W, \partial_+ W)$ such that W cut along \bar{D} is homeomorphic to either a 3-ball or $\partial_- W \times I$ according to whether or not $\partial_- W$ is empty. We say that a component of \bar{D} is a *defining disk*. A *spine* for W is a properly embedded 1-complex Q such that W collapses to $Q \cup \partial_- W$. Dually, if Q is the spine of W , then W is a regular neighborhood of $\partial_- W \cup Q$.

A *3-manifold triad* $(M; N, N')$ is a cobordism M rel ∂ between surfaces N and N' . Thus N and N' are disjoint surfaces in ∂M with $\partial N \cong \partial N'$, such that $\partial M = N \cup N' \cup \partial N \times I$. A *Heegaard splitting* of $(M; N, N')$ is a pair of compression bodies (W, W') such that $W \cup W' = M$, $W \cap W' = \partial_+ W = \partial_+ W' (= F, \text{ say})$ and $\partial_- W = N$, $\partial_- W' = N'$. We call F a *Heegaard surface*. In the following section, we assume that N contains no closed surface.

3. Proof of Proposition 2

Let M and (W, W') be as stated in section 1. Let Q' be a spine for W' , and F a Heegaard surface for (W, W') , and let (D, D') be a pseudo cancelling disk pair in (W, W') . We can see that F is $\text{Fr}_{W'} N(\partial_- W' \cup Q'; W')$ by moving F by a rel ∂ isotopy. Then we may suppose that $N(\partial_- W' \cup Q'; W') \cap D = N((\partial_- W' \cup Q') \cap D; D)$. Hence every component of $\text{Int } D \cap W'$ is a disk or $\text{Int } D \cap W' = \emptyset$. If $\text{Int } D \cap W' = \emptyset$, (D, D') is a cancelling disk pair. Hence, assume that $\text{Int } D \cap W' \neq \emptyset$, and D° denotes the disk with holes $D \cap W$.

Claim 3.1. *We may suppose that $D \cap D' = \partial D \cap \partial D'$: a single point.*

Proof. Each component of $\text{Int } D \cap D'$ is a loop or an arc properly embedded in disks $\text{Int } D \cap W'$. Since W' is irreducible, we may suppose that $\text{Int } D \cap D'$ consists of arcs by an isotopy. Let E be a component of $\text{Int } D \cap W'$ and δ an outermost arc of $\text{Int } D \cap D'$ in E . By cut and paste of D' along δ , we have two disks D'_1 and D'_2 . Since $\partial D \cap \partial D'$ consists of a single point, $\partial D'_1$ or $\partial D'_2$, say $\partial D'_1$, intersects ∂D in a single point. Thus we have a pseudo cancelling disk pair (D, D'_1) such that $\#\{\text{Int } D \cap D'_1\} < \#\{\text{Int } D \cap D'\}$. Then, put $D'_1 = D'$. Continuing in this way, we finally obtain a pseudo cancelling disk pair (D, D') such that $\text{Int } D \cap D' = \emptyset$. This is the conclusion.

Let α be an essential arc in D° . The arc α is called a *recurrent arc* if both of its end points lie in one component of ∂D° . Suppose that α is non-recurrent, and that there is a disk B in W such that $B \cap \partial_+ W = \partial B \cap \partial_+ W = \alpha'$: an arc such that $\alpha \cup \alpha' = \partial B$ (note that, possibly, $\text{Int } B \cap D^\circ \neq \emptyset$). Let ω be one component of $\partial D^\circ - \partial D$ containing a point from $\partial \alpha$.

Lemma 3.2. *Suppose that $\omega \cap \partial B$ consists of a single point (i.e., a component of $\partial \alpha$). Then, F is rel ∂ isotopic to a surface \bar{F} such that :*

- (1) (D, D') is a pseudo cancelling disk pair for the Heegaard splitting (\bar{W}, \bar{W}') induced by \bar{F} ,
- (2) each component of $D \cap \bar{W}'$ is a disk,
- (3) $\#\{D \cap \bar{W}'\} < \#\{D \cap W'\}$.

Proof. The idea of this proof is due to Lemma 2.1 in [11]. This can be proved as well by the inverse argument of isotopy of type A introduced in [16]. Let E be the component of $\text{Int } D \cap W'$ whose boundary is ω , and e a center of E . The core of $N(E; W')$ is of the form $e \times I$, say β , which is a subarc of Q' . Let $e_0(e_1$ resp.) be a point for $e \times \{0\}(e \times \{1\}$ resp.) such that e_0 is in the side of B with respect to D and e_1 is in the other side. Slide e_0 on Q' and $\partial_- W'$ along B fixing e_1 . Then we can see that β is parallel with α in $N(D; M)$ after this isotopy, since $\omega \cap \partial B$ consists of one point (see Figure 3.1). Thus $\#\{D \cap W'\}$ is reduced by moving F by an isotopy. Moreover, after this isotopy, each component of $D \cap W'$ is a disk and $\partial D \cap \partial D'$ still consists of a single point, since we move $N(E; W')$ only in this isotopy.

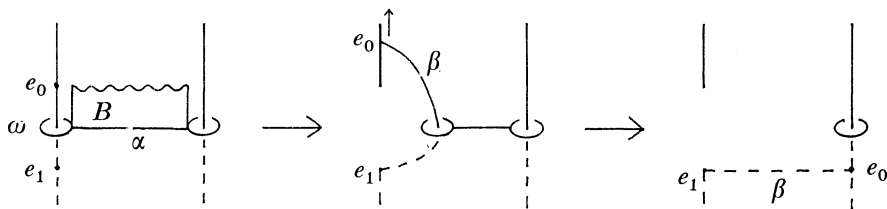

Figure 3.1

Assume that (D, D') is a pseudo cancelling disk pair such that each component of $\text{Int } D \cap W'$ is a disk and that $\#\{D \cap W'\}$ is minimal. Then we have:

Claim 3.3. $D \cap W(=D^\circ)$ is incompressible in W .

A properly embedded disk E in a compression body W is a *product disk* if $\partial E \cap \partial(\partial_- W) \times I$ consists of two essential arcs in $\partial(\partial_- W) \times I$.

A *complete disk system* of W is a system of disks $\{E_i\}$ in W which satisfies the following conditions:

- (1) each E_i is a defining disk or a product disk,

(2) each component of $\text{cl}(W - \cup N(E_i; W))$ is a 3-ball.

(There is a complete disk system of W , since $\partial_- W$ contains no closed surface by the assumption.)

We can observe that $D^\circ \cap \{\cup E_i\}$ consists of loops and arcs properly embedded in D° . Further, we may suppose that $\partial N(D'; W') \cap \partial\{\cup E_i\}$ are disjoint from $\partial N(D'; W') \cap \partial D$, by moving E_i , if necessary, by an isotopy.

By using the standard innermost circle and outermost arc argument, we obtain the following claim.

Claim 3.4. *We may assume that $D^\circ \cap \{\cup E_i\}$ consists of essential arcs.*

By Claim 3.3, we have the next claim.

Claim 3.5. *$D^\circ \cap \{\cup E_i\}$ is a complete system of arcs for D° .*

Proof of Proposition 2.

Case 1. All components of $D^\circ \cap \{\cup E_i\}$ are non-recurrent.

Let α be a component of $D^\circ \cap \{\cup E_i\}$, and E a component of $\{E_i\}$ containing α . Let α' be an outermost arc of $D^\circ \cap E$ on E with respect to α , and E' a subdisk in E which is bounded by α' and ∂E . Thus we have a non-recurrent arc α' of Lemma 3.2, and it contradicts the minimality of $\#\{D \cap W'\}$. Then we have the conclusion of Proposition 2.

Case 2. There is a recurrent arc α in $D^\circ \cap \{\cup E_i\}$.

Let $D^{\circ'}$ be a disk with holes which are bounded by α and ∂D° which contains $\partial\alpha$. We can suppose that there is no recurrent arc in $D^{\circ'} \cap \{\cup E_i\}$ by repeating that operation, if necessary. Then there is a non-recurrent arc in $D^{\circ'} \cap \{\cup E_i\}$ by Claim 3.5. Let β be a component of their non-recurrent arcs, and ω a component of $\partial D^{\circ'}$ which contains a component of $\partial\beta$ and does not contain $\partial\alpha$. E denotes a component of $\{\cup E_i\}$ containing β , and take E' the closure of a component of $E - \beta$. Let β' be an outermost arc with respect to β in $D^{\circ'} \cap E'$ whose boundary is contained in ω . Then, β' is the non-recurrent arc of Lemma 3.2. If there is no such arc, then β is the non-recurrent arc of Lemma 3.2. This contradicts the minimality of $\#\{D \cap W'\}$, and we have the conclusion of Proposition 2.

4. Handle number

In this section, we give firstly some definitions connected with sutured manifolds and Murasugi sum. Next, we give some lemmas with respect to the properties of a handle number and a compression body. For the proofs of them, see [7].

For the definitions of standard terms of sutured manifolds, see [4] and [18]. We say that a sutured manifold (M, γ) is a *product sutured manifold* if (M, γ) is homeomorphic to $(F \times I, \partial F \times I)$ with $R_+(\gamma) = F \times \{1\}$, $R_-(\gamma) = F \times \{0\}$, $A(\gamma) = \partial F \times I$, where F is a surface and I is the unit interval $[0, 1]$. Let L be an oriented link in S^3 and R a Seifert surface for L . The *exterior* $E(L)$ of L is the closure of $S^3 - N(L; S^3)$. Then $R \cap E(L)$ is homeomorphic to R , and we often abbreviate $R \cap E(L)$ to R . $(N, \delta) = (N(R; E(L)), N(\partial R; \partial E(L)))$ has a product sutured manifold structure $(R \times I, \partial R \times I)$. (N, δ) is called the *product sutured manifold for R* . The sutured manifold $(N^c, \delta^c) = (\text{cl}(E(L) - N), \text{cl}(\partial E(L) - \delta))$ with $R_+(\delta^c) = R_-(\delta)$ is the *complementary sutured manifold for R* .

Sutured manifold decomposition is an operation to obtain a new sutured manifold (M', γ') from a sutured manifold (M, γ) by decomposing along an oriented proper surface S (see [4]). The notation for this operation is as follows:

$$(M, \gamma) \xrightarrow{S} (M', \gamma')$$

A surface $R(\subset S^3)$ is a *2n-Murasugi sum* of two surfaces R_1 and R_2 in S^3 if:

- (1) $R = R_1 \cup_D R_2$, where D is a $2n$ -gon, i.e., $\partial D = \mu_1 \cup \nu_1 \cup \cdots \cup \mu_n \cup \nu_n$ (possibly $n=1$), where $\mu_i(\nu_i$ resp.) is an arc properly embedded in $R_1(R_2$ resp.).
- (2) There exist 3-balls B_1, B_2 in S^3 such that:
 - (i) $B_1 \cup B_2 = S^3$, $B_1 \cap B_2 = \partial B_1 = \partial B_2 = S^2$: a 2-sphere,
 - (ii) $R_1 \subset B_1$, $R_2 \subset B_2$ and $R_1 \cap S^2 = R_2 \cap S^2 = D$.

When D is a 2-gon, the Murasugi sum is known as a connected sum. When D is a 4-gon, the Murasugi sum is known as a plumbing. This paper focuses on a plumbing mainly. Put $L = \partial R$. Note that $R' = (R - D) \cup D'$ is an oriented surface with $\partial R' = L$ where $D' = \partial B_1 - \text{Int } D$. By a tiny isotopy of S^3 keeping L fixed we can move R' so that $R' \cap R \cap E(L) = \phi$. We will say that R' is a *dual* of R . Note that R' is also a $2n$ -Murasugi sum of R'_1 and R'_2 where $R'_i = (R_i - D) \cup D'(i=1, 2)$.

Let R be a Seifert surface obtained by a plumbing of two Seifert surfaces R_1 and R_2 whose complementary sutured manifolds (M_1, γ_1) and (M_2, γ_2) are irreducible, and let (M, γ) be the complementary sutured manifold for R . By the definition of a plumbing, there is a 2-sphere S^2 along which R is summed and the summing disk D . Let S be the 8-gon $S^2 - (\text{Int } D \cup \text{Int } N(\partial R))$ and we call S a *cross-section disk* in this paper.

Next lemma follows from [5], [7].

Lemma 4.1 (cf. [5], [7]). *(M_1, γ_1) and (M_2, γ_2) are obtained from (M, γ) by the sutured manifold decomposition along S with an appropriate orientation. (see Figure 4.1.)*

Since (M_1, γ_1) and (M_2, γ_2) are obtained from (M, γ) by a sutured manifold

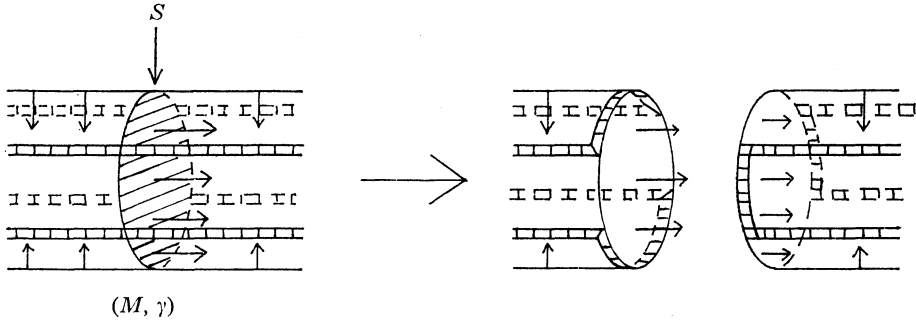

Figure 4.1

decomposition along S , we call M_i in M the part of M_i ($i=1, 2$). Let $S_1(S_2$ resp.) be the component of $\text{Fr}_M N(S; M)$ in the part of M_1 (the part of M_2 resp.). Then we may suppose that $N(S; M) = S \times I$, $S = S \times \{1/2\}$, $S_1 = S \times \{0\}$ and $S_2 = S \times \{1\}$. Moreover, let $a_i (1 \leq i \leq 4)$ be a set of points cyclic ordering on $\partial S \cap s(\gamma)$, then we can suppose that each component of $s(\gamma) \cap N(S; M)$ is of the form $a_i \times I$, and set $a_i^1 = a_i \times \{0\}$ and $a_i^2 = a_i \times \{1\}$ ($1 \leq i \leq 4$).

In the following, we identify (M_1, γ_1) ((M_2, γ_2) resp.) with the component of the sutured manifold obtained from (M, γ) by decomposing along S_2 (S_1 resp.) which contains the part of M_1 (M_2 resp.). Further, we assume that each component of $S_2 \cap s(\gamma_1)$ ($S_1 \cap s(\gamma_2)$ resp.) joins a_i^2, a_{i+1}^2 (a_i^1, a_{i+1}^1 resp.) for i odd (for i even resp.).

Let (W, W') be a Heegaard splitting of $(M; R_+(\gamma), R_-(\gamma))$ and F the Heegaard surface. F is said to be a nice Heegaard surface of $(M; R_+(\gamma), R_-(\gamma))$ if it satisfies the following conditions:

- (1) $S_1 \cap F$ consists of arcs joining a_i^1 and a_{i+1}^1 for i even,

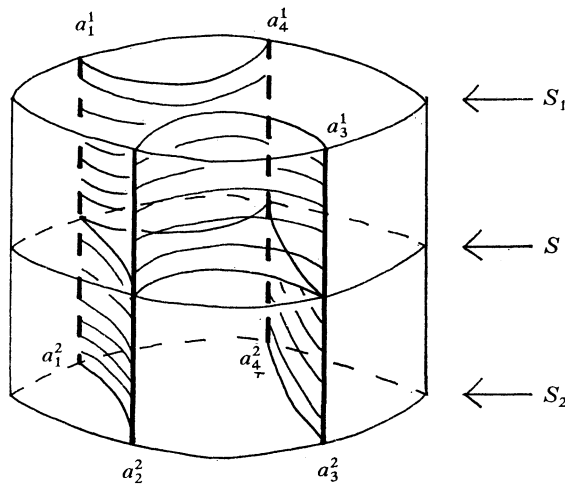

Figure 4.2

- (2) $S_2 \cap F$ consists of arcs joining a_i^2 and a_{i+1}^2 for i odd,
 (3) $F \cap (S \times I)$ is a disk.

The next proposition follows from [7].

Proposition 4.2 ([7], Proposition 3.1). *We can assume that each component of $S \cap W'$ is a product disk by moving F by a rel ∂ isotopy. (see Figure 4.3.)*

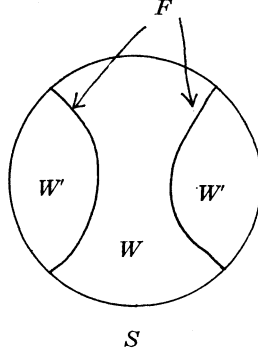

Figure 4.3

Let P be a properly embedded surface in a compression body W . P is called *boundary compressible toward $\partial_+ W$* if there exists a disk D in W such that $D \cap P = \alpha$:an arc in ∂D and $D \cap \partial_+ W = \beta$:an arc in ∂D , with $\alpha \cap \beta = \partial\alpha = \partial\beta$, $\alpha \cup \beta = \partial D$, and either α is essential in P or α is inessential in P and the boundaries of all disk components of $\text{cl}(P - \alpha)$ intersect $\partial(\partial_- W) \times I$. If P is not boundary compressible toward $\partial_+ W$, then we say that P is *boundary incompressible toward $\partial_+ W$* .

Now, let P be a connected surface properly embedded in a compression body W such that each component of $\partial P \cap \partial(\partial_- W) \times I$ is an essential arc in $\partial(\partial_- W) \times I$.

Lemma 4.3 ([7], Lemma 2.3). *Assume that $\partial P \cap \partial_+ W \neq \emptyset$ and P is incompressible and boundary incompressible toward $\partial_+ W$. Then P is*

- (1) *an annulus such that one boundary component is contained in $\partial_+ W$ and the other is contained in $\partial_- W$,*
- (2) *a disk whose boundary component is contained in $\partial_+ W$, or*
- (3) *a product disk in W .*

Suppose that (W, W') is a Heegaard splitting of $(M; R_+(\gamma), R_-(\gamma))$ such that $h(W) = h(R)$. By Proposition 4.2, we may suppose that every component of $S \cap W$ and $S \cap W'$ is a disk as illustrated in Figure 4.3 and that each component of $S \cap F$ joins a_i, a_{i+1} for i even. By Lemma 4.3, we can see that $S \cap W$ has a boundary compressible disk D toward $\partial_+ W$. If D is contained in the part of

M_2 , we say that D is *good*. If D is contained in the part of M_1 , we say that D is *bad*. Note that if D is good, then F is isotopic to a nice Heegaard surface. Then, we have the following inequalities concerning the handle numbers of R , R_1 and R_2 .

Lemma 4.4 (cf. [7], Lemma 4.6). *If D is good, then $h(R_1)+h(R_2)\leq h(R)$. If D is bad, then $h(R_1)+h(R_2)-1\leq h(R)$.*

Next, we define a product disk and a product decomposition for a sutured manifold (M, γ) .

A properly embedded disk E in (M, γ) is a *product disk* if $\partial E \cap A(\gamma)$ consists of two essential arcs in $A(\gamma)$. A *product decomposition* $(M, \gamma) \xrightarrow{E} (M', \gamma')$ is a sutured manifold decomposition along a product disk E . Note that each compression body W can be regarded as a sutured manifold with $A(\gamma) = \partial(\partial_- W) \times I$. In this sense, we can see that this definition of a product disk is equivalent to the preceding definition for a compression body (W, γ) .

The next lemma shows a property of a compression body.

Lemma 4.5 ([7], Lemma 2.4). *Let (W, γ) be a sutured manifold and (W', γ') the sutured manifold obtained from (W, γ) by a product decomposition. Then (W, γ) is a compression body if and only if (W', γ') is a compression body. Moreover, $h(W) = h(W')$.*

5. Marked sutured manifolds and Proof of Theorem 1

Firstly, we give the definition of a marked sutured manifold following [12].

A *marked sutured manifold* (M, γ, A) is a sutured manifold (M, γ) together with a properly embedded arc $A \subset R(\gamma)$. We call A a *mark* on (M, γ) .

Let L be a non-split link and R its Seifert surface. Suppose that R is a plumbing of R_1 and R_2 where R_i ($i=1, 2$) is a Seifert surface for a link L_i ($i=1, 2$). We denote that $D = R_1 \cap R_2$. Let (M_1, γ_1) and (M_2, γ_2) ((N_1, δ_1) and (N_2, δ_2) resp.) be the complementary sutured manifolds (the product sutured manifolds resp.) for R_1 and R_2 respectively. We will produce marked sutured manifolds (M_i, γ_i, A_i) and (N_i, δ_i, A_i) ($i=1, 2$) as follows. We first consider (M_1, γ_1) and (N_1, δ_1) . Let I_1 be a core of D relative to the embedding $D \subset R_1$ i.e., I_1 is a properly embedded arc in R_1 so that D is a regular neighborhood of I_1 in R_1 . Push out I_1 from R_1 to the side on which R_2 is attached, and consider this arc A_1 to be properly embedded in $R(\gamma_1) = R(\delta_1)$. Thus we get marked sutured manifolds (M_1, γ_1, A_1) and (N_1, δ_1, A_1) . By the same way, we also get (M_2, γ_2, A_2) and (N_2, δ_2, A_2) (see Figure 5.1). These markings correspond to the plumbings of R_1 and R_2 .

Let E be a product disk in a marked sutured manifold (M, γ, A) . If A

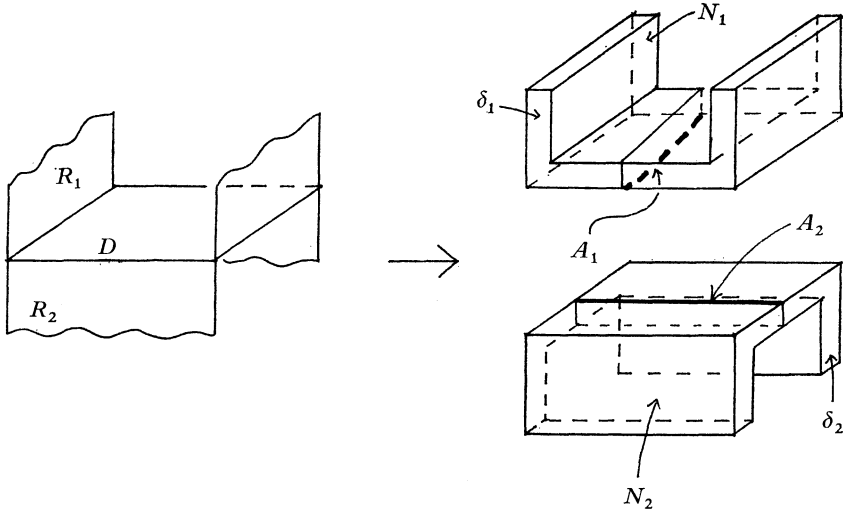

Figure 5.1

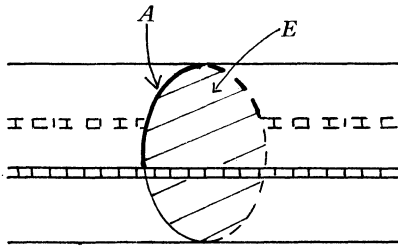

Figure 5.2

is contained in ∂E , then we call E a *product disk with A as an edge*.

Proof of Theorem 1.

By Theorem *A*, we see that $h(R_1)+h(R_2)-1 \leq h(R) \leq h(R_1)+h(R_2)$. Now, we assume that $h(R_1)+h(R_2)-1=h(R)$. Let (W, W') be a Heegaard splitting of $(M; R_+(\gamma), R_-(\gamma))$ such that $h(W)=h(R)$, where (M, γ) is the complementary sutured manifold for R . Let F be the Heegaard surface of (W, W') and S the cross-section disk. By Proposition 4.2, we may suppose that each component of $S \cap W'$ is a product disk as illustrated in Figure 4.3 and that each component of $S \cap F$ joins a_i, a_{i+1} for i even. By Lemmas 4.3 and 4.4, we can see that $S \cap W$ has a bad compressing disk. After compressing along this disk, attach a 1-handle on $\partial_+ W$ as illustrated in Figure 5.3. Let \tilde{F} be the surface obtained from F , and let \tilde{W} and \tilde{W}' be the closure of the components of $M - \tilde{F}$ corresponding to W and W' respectively.

Claim. (\tilde{W}, \tilde{W}') is a Heegaard splitting of $(M; R_+(\gamma), R_-(\gamma))$.

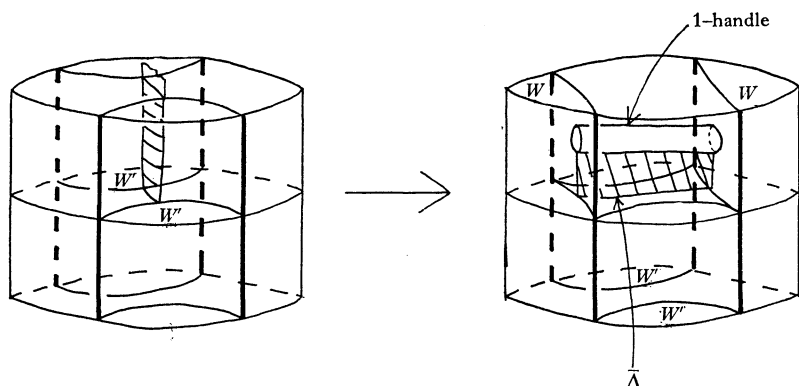

Figure 5.3

Proof. Since \bar{W} is obtained from a compression body W by attaching 1-handle on $\partial_+ W$, \bar{W} is a compression body. On the other hand, a compression body W' is obtained from \bar{W}' by the decomposition along $\bar{\Delta}$ where $\bar{\Delta}$ is a thin rectangle as in Figure 5.3. Thus \bar{W}' is also a compression body. Then we have this claim.

By Lemma 4.2 in [7], (\bar{W}, \bar{W}') induces a Heegaard splitting (\bar{W}_i, \bar{W}'_i) of $(M_i; R_+(\gamma_i), R_-(\gamma_i))$ ($i=1, 2$) such that $h(\bar{W})=h(\bar{W}_1)+h(\bar{W}_2)$ since (\bar{W}, \bar{W}') has a nice Heegaard surface (see Figure 5.4).

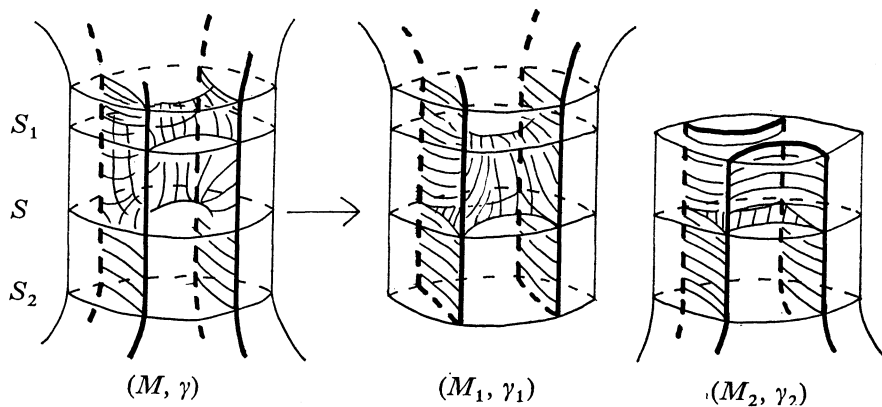

Figure 5.4

We denote E the product disk in the statement of Theorem 1.

By the definition of the mark A_1 , we may suppose that A_1 is contained in $S_2(\subset M_1)$. Then, let Δ be a disk in M_1 such that $\partial\Delta$ contains A_1 as illustrated in Figure 5.5. Further, we may suppose that E contains Δ .

Thus the cocore of attaching 1-handle and a subdisk of E constitute a

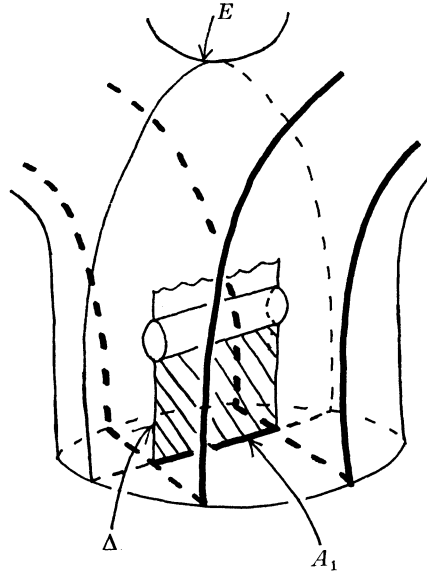

Figure 5.5

pseudo cancelling disk pair. (Note that the subdisk of E is contained in $E - \Delta$, see Figure 5.5). Then we have a cancelling disk pair in (\bar{W}_1, \bar{W}'_1) by Proposition 2. Let (\bar{W}_1, \bar{W}'_1) be the Heegaard splitting of $(M_1; R_+(\gamma_1), R_-(\gamma_1))$ obtained from (\bar{W}_1, \bar{W}'_1) by compressing along this cancelling disk pair. Then, we have that $h(\bar{W}_1) = h(\bar{W}'_1) - 1$. By the definition of a handle number, $h(R_1) \leq h(\bar{W}_1) < h(\bar{W}'_1)$. Then $h(R_1) + h(R_2) < h(\bar{W}_1) + h(\bar{W}'_2) = h(\bar{W}) = h(W) + 1 = h(R) + 1$. Hence $h(R_1) + h(R_2) - 1 < h(R)$, a contradiction. This completes the proof of Theorem 1.

6. Examples

EXAMPLE 6.1. *Let R be an unknotted annulus in S^3 with n -full twists, then $h(R) = 0$ if $n = 1$ and $h(R) = 1$ if $n \geq 2$.*

For a proof of this example, see Example 2.1 in [7].

EXAMPLE 6.2. *Knot 9_{10} has the minimal genus Seifert surface R and its dual surface R' such that $h(R) \neq h(R')$ (for the notation, see [17]).*

Let R be the minimal genus Seifert surface for 9_{10} and R' its dual surface shown in Figure 6.1. R and R' is obtained from R_1 and R_2 as illustrated in Figure 6.1. By Example 6.1 and Theorem B, $h(R_1) = h(R_2) = 1$. Moreover, by Theorem A, we can obtain that $1 \leq h(R), h(R') \leq 2$. Now, we will show that $h(R) = 2$ and $h(R') = 1$.

Firstly, we consider R . Let (M_1, γ_1, A_1) be the marked sutured manifold

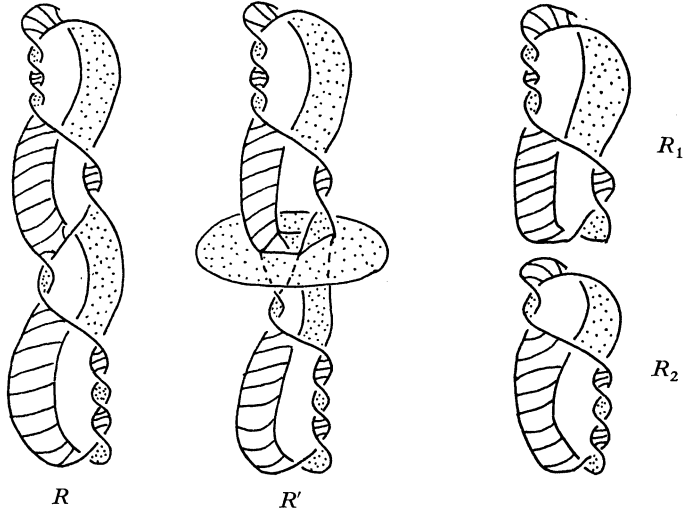

Figure 6.1

for R_1 as illustrated in Figure 6.2. The mark A_1 corresponds to the plumbing which is associated to R and there is a product disk with A_1 as an edge. Then, by Theorem 1, we have that $h(R)=2$.

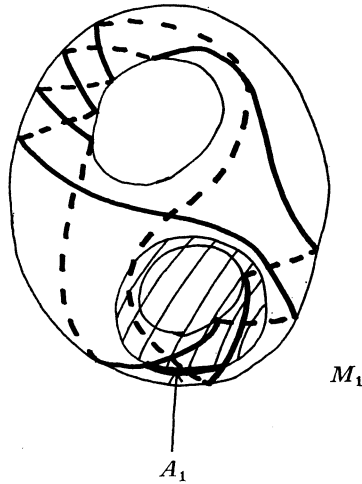

Figure 6.2

Next, we will show that $h(R')=1$. We can see by straightforward observation that R' is ambient isotopic to R'' as in Figure 6.3. Let (N, δ) be the product sutured manifold for R'' and (M, γ) the complementary sutured manifold for R'' . We consider the properly embedded arc α in (M, γ) such that $\partial\alpha \subset R_-(\gamma)=R_+(\delta)$ as illustrated in Figure 6.3.

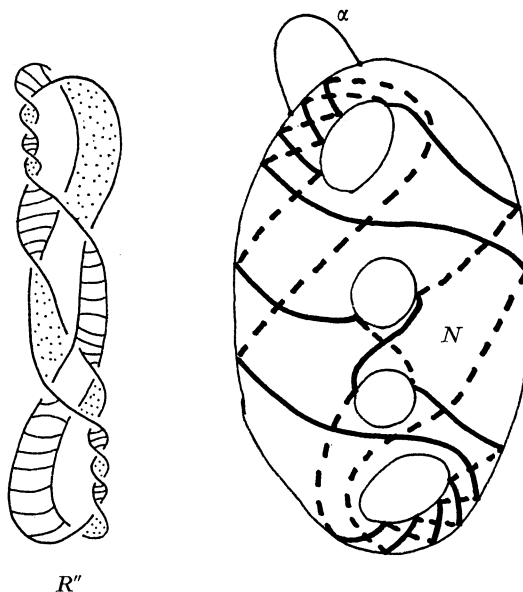

Figure 6.3

Put $X=R_-(\gamma)\times I\cup N(\alpha;M)$; then X is a compression body with $h(X)=1$. On the other hand, by product decompositions and Lemma 4.5, $\text{cl}(M-X)$ is also a compression body with $h(\text{cl}(M-X))=1$. Hence $h(R')=1$.

EXAMPLE 6.3. *The condition of Theorem 1 is not necessary; in fact, there is a Seifert surface R such that $h(R)=2$ and $h(R_1)=h(R_2)=1$ where R is obtained from R_1 and R_2 by a plumbing. Moreover, there is no product disk in M_i with $A_i(i=1, 2)$ as an edge.*

Let R be the incompressible Seifert surface of 10_{67} ; then R is obtained from R_1 and R_2 by a plumbing, as illustrated in Figure 6.4 (cf. [12], Figure 6.11).

We have that $h(R_1)=h(R_2)=1$ and $h(R)\leq 2$ by a similar argument of Example 6.2. Moreover, we can verify that there is no product disk in M_i with $A_i(i=1, 2)$ as an edge by Lemma 4.1 and Proposition 4.2 in [12]. Then we will show that $h(R)=2$. By Theorem B, we may investigate R' instead of R (see Figure 6.5).

Let (N, δ) be a product sutured manifold for R' and (M, γ) the complementary sutured manifold for R' . Now, we assume that $h(R')\leq 1$. Then $H_1(M)/i_*H_1(R_+(\gamma))\approx\langle h|r\rangle$, where h is a generator corresponding to attaching 1-handle and r is a relation arising from a 2-handle. Note that M is obtained from $R_+(\gamma)\times I$ by attaching a 1-handle and a 2-handle by the assumption. This abelian group is generated by a single element. However, this group is isomorphic to $Z_2\oplus Z_6$ for this example. Hence this is a contradiction and $h(R')=2$.

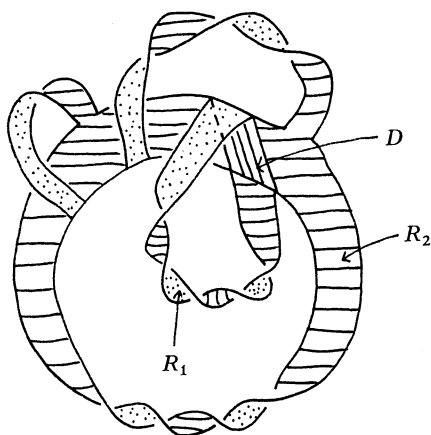

R

Figure 6.4

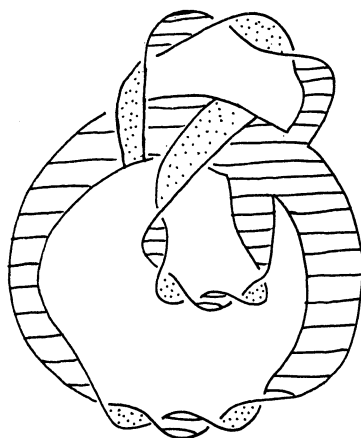

R'

Figure 6.5

7. Handle number of the incompressible Seifert surfaces for prime knots of ≤ 10 crossings

Let R_1 and R_2 be Seifert surfaces for an oriented link L in S^3 . R_1 and R_2 are *equivalent* if R_1 is ambient isotopic to R_2 in the exterior of L . The incompressible Seifert surfaces for prime knots of ≤ 10 crossings are classified by Hatcher and Thurston [8], and Kakimizu [12]. In fact, Kakimizu proved the following theorem.

Theorem ([12]). (I) *The incompressible Seifert surfaces for every prime*

knot of ≤ 10 crossings are unique except for the following knots (see [17] for the notation).

7_4	8_3	9_5	9_{10}	9_{13}	9_{18}	9_{23}	10_3	10_{11}	10_{16}	10_{18}
2	2	2	4	2	3	2	2	2	4	3
10_{24}	10_{28}	10_{30}	10_{31}	10_{33}	10_{37}	10_{38}	10_{53}	10_{67}	10_{68}	10_{74}
3	2	2	3	4	2	2	2	2	2	3

(II) *Each knot in the above table has exactly two, three or four equivalence classes of incompressible Seifert surfaces according to the number written under the knot; moreover they are all of minimal genus.*

Kanenobu and Gabai detected the fibered knots of ≤ 10 crossings in [13] and [6]. Note that a fibered knot has a unique incompressible Seifert surface, that is, a fiber surface. The fibered knots of ≤ 10 crossings are listed in Table I. (For the notation, see [17].) Namely, the handle numbers of incompressible Seifert surfaces corresponding to these knots are equal to 0.

Table I

3_1	4_1	5_1	6_2	6_3	7_1	7_6	7_7	8_2	8_5
8_7	8_9	8_{10}	8_{12}	8_{16}	8_{17}	8_{18}	8_{19}	8_{20}	8_{21}
9_1	9_{11}	9_{17}	9_{20}	9_{22}	9_{24}	9_{26}	9_{27}	9_{28}	9_{29}
9_{30}	9_{31}	9_{32}	9_{33}	9_{34}	9_{36}	9_{40}	9_{42}	9_{43}	9_{44}
9_{45}	9_{47}	9_{48}	10_2	10_5	10_9	10_{17}	10_{29}	10_{41}	10_{42}
10_{43}	10_{44}	10_{45}	10_{46}	10_{47}	10_{48}	10_{59}	10_{60}	10_{62}	10_{64}
10_{69}	10_{70}	10_{71}	10_{73}	10_{75}	10_{78}	10_{79}	10_{81}	10_{82}	10_{85}
10_{88}	10_{89}	10_{91}	10_{94}	10_{96}	10_{99}	10_{100}	10_{104}	10_{105}	10_{106}
10_{107}	10_{109}	10_{110}	10_{112}	10_{115}	10_{116}	10_{118}	10_{123}	10_{124}	10_{125}
10_{126}	10_{127}	10_{132}	10_{133}	10_{136}	10_{137}	10_{138}	10_{139}	10_{140}	10_{141}
10_{143}	10_{145}	10_{148}	10_{149}	10_{150}	10_{151}	10_{152}	10_{153}	10_{154}	10_{155}
10_{156}	10_{157}	10_{158}	10_{159}	10_{160}	10_{161}	10_{162}	10_{164}	—	—

The handle numbers of Seifert surfaces in Table II are all 2. (For the notation, see [8] and [17].) The handle numbers of Seifert surfaces which are not fiber surfaces and are out of Table II are all 1. We note that each knot in Table II has two minimal genus Seifert surfaces whose handle numbers are mutually different.

Table II

knot type	9_{10}		9_{18}	10_{16}
Seifert surface	$[S_1(0, 0, 0)]$	$[S_1(0, 0, 1)]$	$[S_1(0, 0, 0)]$	$[S_1(0, 0, 0)]$
10_{16}	10_{18}	10_{24}	10_{31}	10_{33}
$[S_1(0, 0, 1)]$	$[S_1(0, 0, 0)]$	$[S_1(0, 0, 0)]$	$[S_1(0, 0, 0)]$	$[S_1(0, 0, 0)]$
10_{33}	10_{67}	10_{68}	10_{74}	
$[S_1(0, 0, 1)]$	Figure 6.4	Figure 7.1	Figure 7.2	Figure 7.3

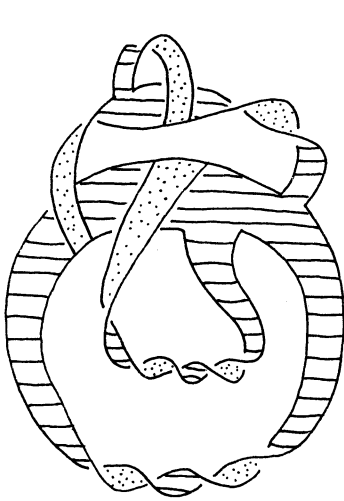

Figure 7.1

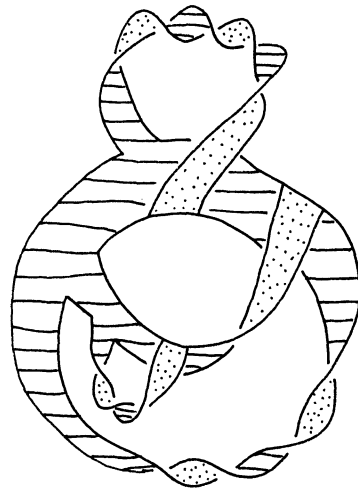

Figure 7.2

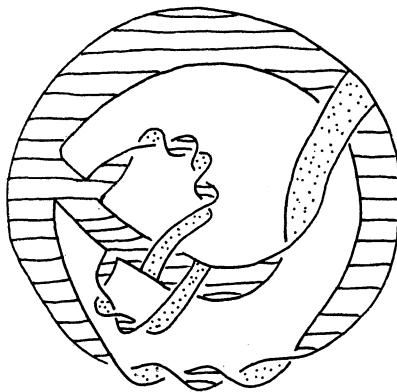

Figure 7.3

References

- [1] A.J. Casson, C.McA. Gordon: *Reducing Heegaard splitting*, Topology and its application. **27** (1987), 275–283.
- [2] C. Frohman: *The topological uniqueness of triply periodic minimal surfaces in \mathbb{R}^3* , J. Differential Geom. **31** (1990), 277–283.
- [3] D. Gabai: *The Murasugi sum is a natural geometric operation*, Contemp. Math. **20** (1983), 131–143.
- [4] D. Gabai: *Foliations and the topology of 3-manifolds*, J. Differential Geom. **18** (1983), 445–503.
- [5] D. Gabai: *The Murasugi sum is a natural geometric operation II*, Contemp. Math. **44** (1985), 93–100.
- [6] D. Gabai: *Detecting fibered links in S^3* , Comm. Math. Helv. **61** (1986), 519–555.
- [7] H. Goda: *Heegaard splitting for sutured manifolds and Murasugi sum*, Osaka J. Math. **29** (1992), 21–40.
- [8] A. Hatcher, W. Thurston: *Incompressible surfaces in 2-bridge knot complements*, Invent. Math. **79** (1985), 225–246.
- [9] J. Hempel: *3-manifolds*, Ann. of Math. Studies 86, Princeton University Press, Princeton N.J., 1976.
- [10] W. Jaco: *Lectures on three manifold topology*, CBMS Regional Conf. Ser. in Math 43, 1980.
- [11] K. Johannson: *On surfaces and Heegaard surfaces*, Trans. Amer. Math. Soc. **325** (1991), 573–591.
- [12] O. Kakimizu: *Classification of the incompressible spanning surfaces for prime knots of ≤ 10 crossings*, preprint.
- [13] T. Kanenobu: *The Augmentation Subgroup of a Pretzel Link*, Math. Seminar Notes, Kobe University, **7** (1979), 363–384.
- [14] T. Kobayashi: *Uniqueness of minimal genus Seifert surfaces for links*, Topology and its application, **33** (1989), 265–279.
- [15] T. Kobayashi: *Fibered Links and unknotting operations*, Osaka J. Math. **26** (1989), 699–742.
- [16] M. Ochiai: *On Haken's theorem and its extension*, Osaka J. Math. **20** (1983), 461–468.
- [17] D. Rolfsen: *Knots and Links*, Mathematical Lecture Series 7, Publish or Perish Inc. Berkeley, 1976.
- [18] M. Scharlemann: *Sutured manifolds and generalized Thurston norms*, J. Differential Geom. **29** (1989), 557–614.
- [19] M. Scharlemann, A. Thompson: *Heegaard splittings of $(\text{surface}) \times I$ are standard*, preprint.

Department of Mathematics
 Faculty of Science
 Osaka University
 Toyonaka, Osaka 560
 Japan