

A CONSTRUCTION OF 3-MANIFOLDS WHOSE HOMEOMORPHISM CLASSES OF HEEGAARD SPLITTINGS HAVE POLYNOMIAL GROWTH

TSUYOSHI KOBAYASHI

(Received July 15, 1991)

1. Introduction

Let M be a closed, orientable 3-manifold. We say that $(V, V'; F)$ is a *Heegaard splitting* of M if V, V' are 3-dimensional handlebodies in M such that $M = V \cup V'$, $V \cap V' = \partial V = \partial V' = F$. Then F is called a *Heegaard surface* of M , and the genus of F is called the *genus* of the Heegaard splitting. We say that two Heegaard splittings $(V, V'; F)$ and $(W, W'; G)$ of M are *homeomorphic* if there is a self-homeomorphism f of M such that $f(F) = G$. Then we denote the number of the homeomorphism classes of the Heegaard splittings of genus g of M by $h_M(g)$ (possibly $h_M(g) = \infty$). We note that K. Johannson showed that if M is a Haken manifold, then $h_M(g)$ is finite for every g [8], [9]. In [12], F. Waldhausen asked whether $h_M(2g) = 1$ provided M admits a Heegaard splitting of genus g . Casson-Gordon showed that the answer to this question is “No”. In fact they showed that there exist infinitely many 3-manifolds M such that $h_M(2n) \geq 2$ for all $n \geq 3$ [5]. In this paper, we improve this result as follows.

Theorem. *For each integer $n (> 1)$, there exist infinitely many Haken manifolds M such that for each integer g greater than or equal to n there exists $\binom{g-1}{n-1}$ mutually non-homeomorphic, strongly irreducible Heegaard splittings of M of genus $4n+2+2g$. In particular $h_M(4n+2+2g) > \binom{g-1}{n-1}$ for $g > n$.*

Since $\binom{g-1}{n-1}$ is a polynomial of g of degree $n-1$, we immediately have:

Corollary. *For each positive integer m , there exist infinitely many Haken manifolds M such that*

$$\limsup_{g \rightarrow \infty} \frac{h_M(g)}{g^m} = \infty.$$

Throughout this paper, we work in the piecewise linear category. All submanifolds are in general position unless otherwise specified. For the de-

definitions of standard terms in 3-dimensional topology, knot and link theory, see [6], [7], and [2]. Let H be a subcomplex of a complex K . Then $N(H; K)$ denotes a regular neighborhood of H in K . Let L be a link in the 3-sphere S^3 . The exterior $E(L)$ of L is the closure of $S^3 - N(L; S^3)$. For a topological space B , $\#B$ denotes the number of the components of B . Let N be a manifold embedded in a manifold M with $\dim N = \dim M$. Then $\text{Fr}_M N$ denotes the frontier of N in M . An arc a properly embedded in a surface S is *inessential* if it is rel ∂ isotopic to an arc in ∂S . If a is not inessential, then it is *essential*. Let S be a connected 2-sided surface properly embedded in a 3-manifold M . We say that S is *essential* if $i_*: \pi_1(S) \rightarrow \pi_1(M)$ is injective and S is not ∂ -parallel.

I would like to express my thanks to Dr. Makoto Sakuma for his careful reading of the manuscript of this work.

2. Essential disks in the exterior of trivial tangles

In this section, we study essential disks in the exterior of a trivial tangle. The results will be used in Sect. 3, and 5. A *tangle* $(B^3; t_1, t_2)$ is a pair of a 3-ball B^3 and mutually disjoint arcs t_1, t_2 properly embedded in B^3 . $(B^3; t_1, t_2)$ is called *trivial* if $(B^3, t_1 \cup t_2)$ is homeomorphic to $(D^2 \times I, p_1 \times I \cup p_2 \times I)$ as pairs, where D^2 is a disk and p_1, p_2 are mutually disjoint points in $\text{Int } D^2$. Let $(B^3; s_1, s_2)$ be a trivial tangle, $H = \text{cl}(B^3 - N(s_1 \cup s_2; B^3))$, and $A_i = \text{Fr}_{B^3} N(s_i; B^3)$ ($i=1, 2$). Then H is a genus two handlebody, and A_1, A_2 are annuli embedded in ∂H . Let \mathcal{D} be a disk properly embedded in H as in Figure 2.1. Then the closures of the components of $H - \mathcal{D}$ are solid tori T_1, T_2 such that $A_i \subset \partial T_i$. Let D be a disk properly embedded in a solid torus. We say that D is a *meridian disk* if it cuts the solid torus into a 3-ball.

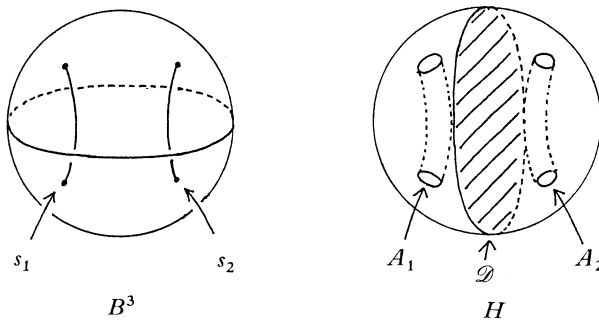

Figure 2.1

Lemma 2.1. *Let D be a disk properly embedded in T_i ($i=1$ or 2) such that $D \cap A_i = \emptyset$. Then D is ∂ -parallel in T_i .*

Proof. Assume that D is not ∂ -parallel. Since T_i is irreducible, we see

that ∂D is not contractible in ∂T_i . Since T_i is irreducible, this shows that D is a meridian disk of the solid torus T_i . Hence D represents a non-trivial element $[D]$ of $H_2(T_i, \partial T_i; Z)$, and, for a generator a of $H_1(T_i, Z) \cong Z$, a and $[D]$ have non-zero intersection number. On the other hand, it is clear that A_i is a deformation retract of T_i . This implies that the intersection number of a and $[D]$ is zero, a contradiction. ■

Lemma 2.2. *Let D be a disk properly embedded in T_i such that $D \cap A_i$ consists of an essential arc in A_i . Then D is a meridian disk of the solid torus T_i .*

Proof. Since $D \cap A_i$ consists of an essential arc in A_i , we see that ∂D is an essential, simple closed curve in ∂T_i . Hence D is a meridian disk of T_i . ■

Lemma 2.3. *Let D be an essential disk in H such that $D \cap (A_1 \cup A_2) = \emptyset$. Then D is rel $(A_1 \cup A_2)$ isotopic to \mathcal{D} .*

Proof. We suppose that $\#(D \cap \mathcal{D})$ is minimal among all disks which are rel $(A_1 \cup A_2)$ isotopic to D . By using standard innermost circle arguments, we see that no component of $D \cap \mathcal{D}$ is a circle. Then we have:

Claim. $\#(D \cap \mathcal{D}) = 0$.

Proof. Assume that $\#(D \cap \mathcal{D}) > 0$. Let α be a component of $D \cap \mathcal{D}$ which is outermost in D , and $\Delta (\subset D)$ an outermost disk such that $\text{Fr}_D \Delta = \alpha$. Let Δ' be the closure of a component of $\mathcal{D} - \alpha$. Then Δ is contained in either T_1 or T_2 , say T_1 . Let Δ^* be a properly embedded disk in T_1 obtained from $\Delta \cup \Delta'$ by pushing Δ' to T_1 (hence, $\Delta^* \cap \mathcal{D} = \emptyset$). By Lemma 2.1, Δ^* is ∂ -parallel. Hence it is easy to see that D is rel $(A_1 \cup A_2)$ isotopic to a disk D' such that no component of $D' \cap \mathcal{D}$ is a circle, and $\#(D' \cap \mathcal{D}) < \#(D \cap \mathcal{D})$, a contradiction.

This completes the proof of Claim.

This claim together with Lemma 2.1 shows that D is parallel to \mathcal{D} in H . ■

Lemma 2.4. *Let D be a disk properly embedded in H such that $D \cap (A_1 \cap A_2)$ consists of an essential arc in A_1 or A_2 . Then D is properly isotopic in $(H, A_1 \cup A_2)$ to one of the disks in Figure 2.2.*

Proof. By using the argument in the proof of Lemma 2.3, we see that D is rel $(A_1 \cup A_2)$ isotopic to a disk D' which does not intersect \mathcal{D} (hence $D' \subset T_1$ or $D' \subset T_2$). Then by Lemma 2.2, we easily see that D' is properly isotopic in $(H, A_1 \cup A_2)$ to one of the disks in Figure 2.2. ■

Lemma 2.5. *Let D be an essential disk properly embedded in H such that $D \cap (A_1 \cup A_2)$ consists of an inessential arc α in A_1 or A_2 , say A_1 . Then D is properly isotopic in $(H, A_1 \cup A_2)$ to one of the disks in Figure 2.3.*

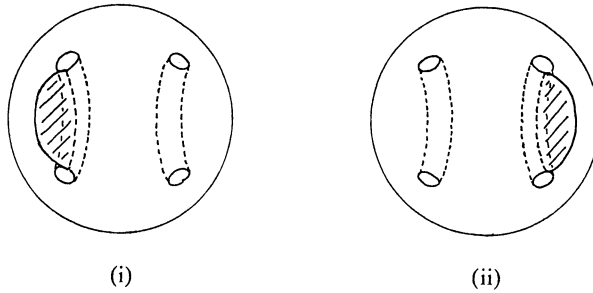

Figure 2.2

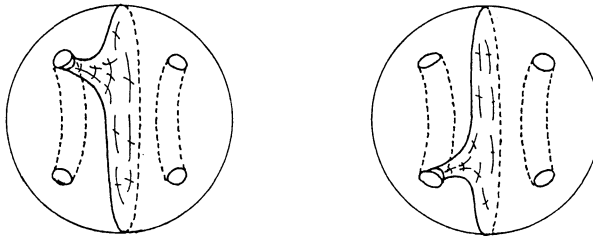

Figure 2.3

Proof. Since α is an inessential arc, there is a disk Δ in A_1 such that $\text{Fr}_{A_1} \Delta = \alpha$. Let D' be a properly embedded disk in H obtained from $D \cup \Delta$ by pushing Δ into H (hence, $D' \cap (A_1 \cup A_2) = \emptyset$). Then, by Lemma 2.3, D' is $\text{rel}(A_1 \cup A_2)$ isotopic to \mathcal{D} . This shows that D is properly isotopic in (T_1, A_2) to a disk obtained from \mathcal{D} by pushing it along an arc γ properly embedded in $\text{cl}(\partial T_1 - (A_1 \cup \mathcal{D}))$ with

(*) $\gamma \cap \partial A_1 \neq \emptyset, \gamma \cap \partial \mathcal{D} \neq \emptyset$.

It is easy to see that the arcs in $\text{cl}(\partial T_1 - (A_1 \cup \mathcal{D}))$ with this property (*) have exactly two proper isotopy classes in $\text{cl}(\partial T_1 - (A_1 \cup \mathcal{D}))$ (Figure 2.4), and we have the conclusion of Lemma 2.5. ■

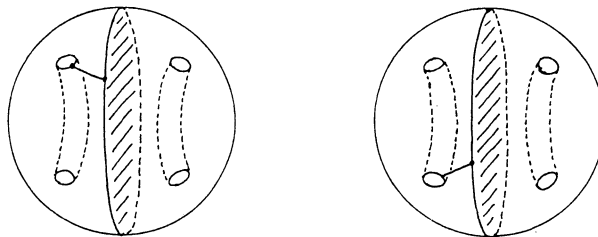

Figure 2.4

In the following lemmas of this section, let $P = \text{cl}(\partial H - (A_1 \cup A_2))$.

Lemma 2.6. *Let D be a disk properly embedded in H such that $D \cap (A_1 \cup A_2)$ consists of two essential arcs a', a'' in $A_1 \cup A_2$, and each component of $\partial D \cap P$ is an essential arc in P . Then there is a proper homeomorphism $h: (H, A_1 \cup A_2) \rightarrow (H, A_1 \cup A_2)$ such that $h(D)$ is either one of the disks in Figure 2.5.*

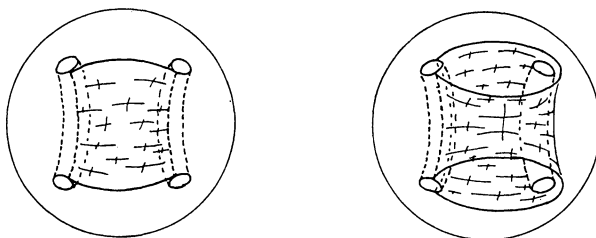

Figure 2.5

Proof. Without loss of generality, we may suppose that $a' \subset A_1$. We suppose that $\#(D \cap \mathcal{D})$ is minimal among all disks properly isotopic to D in $(H, A_1 \cup A_2)$. By using standard innermost circle arguments, we see that no component of $D \cap \mathcal{D}$ is a circle. Then we have:

Claim. $D \cap \mathcal{D} \neq \emptyset$

Proof. Assume that $D \cap \mathcal{D} = \emptyset$ (hence $D \subset T_1$). Since each component of $\partial D \cap P$ is an essential arc in P , we easily see that each component of $\partial D \cap P$ joins different components of ∂A_1 . Hence for a generator a of $H_1(T_1; \mathbb{Z}) (\cong H_1(A_1; \mathbb{Z}))$, the intersection number of a with $[D] (\in H_2(T_1, \partial T_1; \mathbb{Z}))$ is ± 2 , a contradiction.

This completes the proof of Claim.

Let $\alpha (\subset \mathcal{D})$ be an outermost component of $D \cap \mathcal{D}$, and $\Delta (\subset \mathcal{D})$ an outermost disk such that $\text{Fr}_p \Delta = \alpha$. By the minimality of $\#(D \cap \mathcal{D})$ and the outermost arc argument used in the proof of Lemma 2.3, we see that α joins different components of $\partial D \cap P$. Hence, by ∂ -compressing D along Δ , we have two disks D', D'' properly embedded in H such that $D' \cap (A_1 \cup A_2) = a'$, and $D'' \cap (A_1 \cup A_2) = a''$. Then, by using the argument in the proof of Lemma 2.4, we see that $D' \cup D'' (\subset H)$ is homeomorphic to either Figure 2.6 (i) (case $a'' \subset A_2$), or Figure 2.6 (ii) (case $a'' \subset A_1$). Hence we see that D is properly isotopic in $(H, A_1 \cup A_2)$ to a disk obtained from either one of $D' \cup D''$ of Figure 2.6 by joining them along an arc γ such that $\gamma \subset P$, $\gamma \cap D'$ is a component of $\partial \gamma$, and $\gamma \cap D''$ is the other component of $\partial \gamma$. Since each component of $\partial D \cap P$ is an essential arc in P , we easily see that there is a proper homeomorphism f of $(H, A_1 \cup A_2)$ such that $f(\gamma) = \delta$, where δ is either one of the arcs in Figure 2.6, and this completes the proof of Lemma 2.6. ■

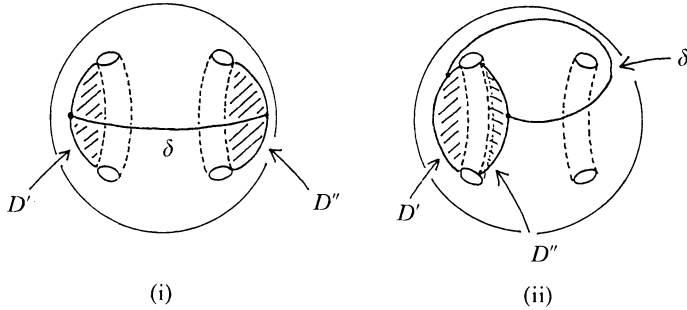

Figure 2.6

Lemma 2.7. *Let D be a disk properly embedded in H such that $D \cap (A_1 \cup A_2)$ consists of two arcs a', a'' such that a' is essential, and a'' is inessential in $A_1 \cup A_2$, and each component of $\partial D \cap P$ is an essential arc in P . Then there is a proper homeomorphism $h: (H, A_1 \cup A_2) \rightarrow (H, A_1 \cup A_2)$ such that $h(D)$ is either one of the disks in Figure 2.7.*

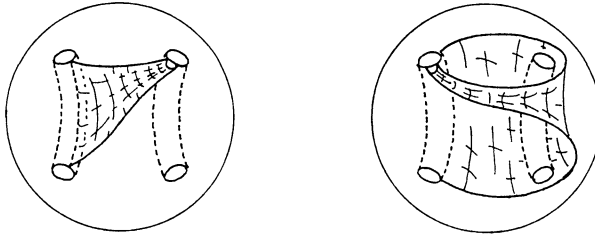

Figure 2.7

Proof. Without loss of generality, we may suppose that $a' \subset A_1$. Since a'' is an inessential arc, there is a disk Δ'' in $A_1 \cup A_2$ such that $\text{Fr}_{A_1 \cup A_2} \Delta'' = a''$. Since a' is essential, we have $a' \cap \Delta'' = \emptyset$. Let D^* be a properly embedded disk in H obtained from $D \cup \Delta''$ by pushing Δ'' into H (hence, $D^* \cap (A_1 \cup A_2) = a'$). By Lemma 2.4, we see that D^* is properly isotopic in $(H, A_1 \cup A_2)$ to the disk in Figure 2.2 (i). Moreover D is properly isotopic in $(H, A_1 \cup A_2)$ to a disk obtained from D^* in Figure 2.2 (i) by pushing it along an arc γ in P such that $\gamma \cap D^*$ is a component of $\partial \gamma$, and $\gamma \cap \partial P$ is the other component of $\partial \gamma$. Since each component of $\partial D \cap P$ is an essential arc in P , we easily see that there is a proper homeomorphism f of $(H, A_1 \cup A_2)$ such that $f(\gamma) = \delta$, where δ is either one of the arcs in Figure 2.8, and this completes the proof of Lemma 2.7. ■

Lemma 2.8. *Let D be an essential disk properly embedded in H such that $D \cap (A_1 \cup A_2)$ consists of two inessential arcs a', a'' in $A_1 \cup A_2$, and each component of $\partial D \cap P$ is an essential arc in P . Then there is a proper homeomorphism $h: (H, A_1 \cup A_2) \rightarrow (H, A_1 \cup A_2)$ such that $h(D)$ is either one of the disks in Figure 2.9.*

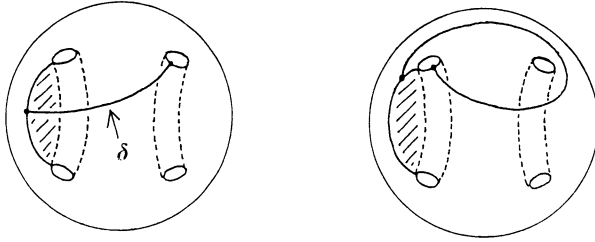

Figure 2.8

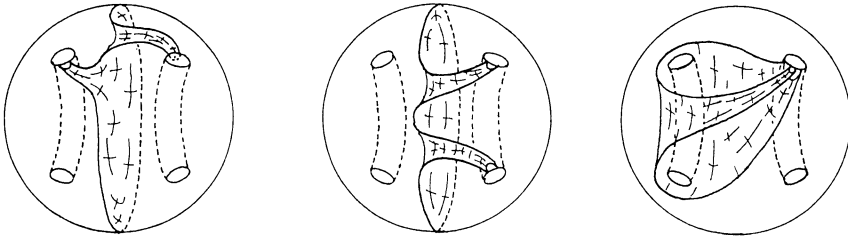

Figure 2.9

Proof. Since a' is an inessential arc in $A_1 \cup A_2$, there is a disk Δ' in $A_1 \cup A_2$ such that $\text{Fr}_{A_1 \cup A_2} \Delta' = a'$. By exchanging a' and a'' if necessary, we may suppose that $a'' \cap \Delta' = \emptyset$. Moreover, without loss of generality, we may suppose that $a'' \subset A_2$. Let D' be a properly embedded disk obtained from $D \cup \Delta'$ by pushing Δ' into H (hence $D' \cap (A_1 \cup A_2) = a'$). Since a proper homeomorphism of $(H, A_1 \cup A_2)$ can exchange the components of ∂A_2 , we may suppose that D' is properly isotopic to the disk D^* of Figure 2.10 by Lemma 2.5. Hence D is properly isotopic in $(H, A_1 \cup A_2)$ to a disk obtained from the disk D^* of Figure 2.10 by pushing it along an arc γ in P such that $\gamma \cap D^*$ is a component of $\partial \gamma$, and $\gamma \cap \partial P$ is the other component of $\partial \gamma$. Since each component of $\partial D \cap P$ is an essential arc in P , we easily see that there is a proper homeomorphism f of $(H, A_1 \cup A_2)$ such that $f(\gamma) = \delta$, where δ is either one of the arcs in Figure 2.10, and this completes the proof of Lemma 2.8. ■

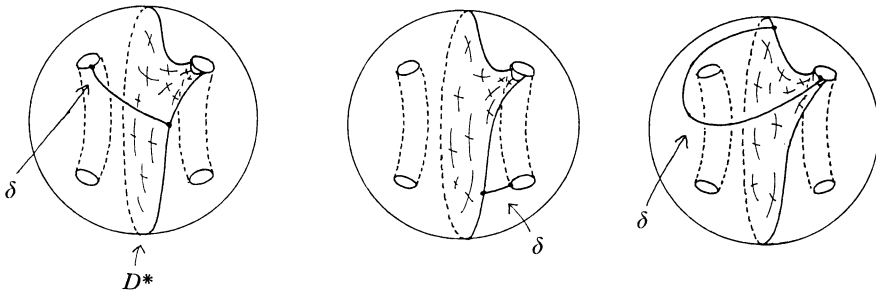

Figure 2.10

As a consequence of Lemmas 2.4 and 2.5, we have:

Proposition 2.9. *Let D be an essential disk properly embedded in H such that $\partial D \cap P$ consists of an arc β of P . Then there is a proper homeomorphism h of (H, P) such that $h(\beta)$ is either one of the arcs in Figure 2.11.*

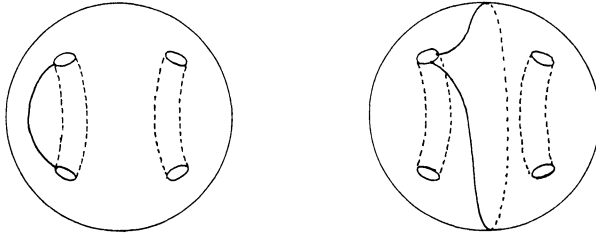
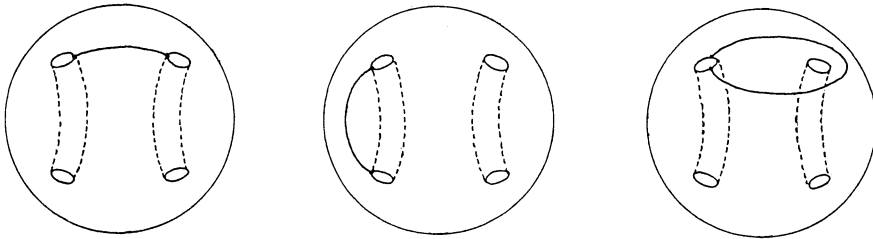

Figure 2.11

As a consequence of Lemmas 2.6, 2.7, and 2.8, we have:

Proposition 2.10. *Let D be an essential disk properly embedded in H such that $\partial D \cap P$ consists of two essential arcs in P . Then, for a component β of $\partial D \cap P$, there is a proper homeomorphism h of (H, P) such that $h(\beta)$ is either one of the arcs in Figure 2.12.*



(i)

(ii)

(iii)

Figure 2.12

3. A construction of irreducible Heegaard splittings

In this section, we give a construction of Heegaard splittings of a certain kind of 3-manifolds, and give a proposition concerning the irreducibility of the Heegaard splittings. The construction will be used in the proof of the main result of this paper.

Let $(H, A_1 \cup A_2)$, P be as in section 2, and $(H', A'_1 \cup A'_2)$, P' spaces homeomorphic to $(H, A_1 \cup A_2)$, P respectively. Let $g: P \rightarrow P'$ be an orientation reversing homeomorphism with $g(\partial A_i) = \partial A'_i (i=1, 2)$. Recall that a two bridge link

is a link in S^3 which is expressed as a union of two trivial tangles (cf. [2]). Hence the manifold $H \cup_g H'$ is homeomorphic to the exterior $E(L)$ of a two bridge link $L=l_1 \cup l_2$ such that each component of $\partial A_i (= \partial A'_i)$ corresponds to a meridian loop of l_i . Let N be an orientable, irreducible, ∂ -irreducible (possibly disconnected) 3-manifold such that ∂N consists of two tori T_1, T_2 , and each component of N has non-empty boundary (hence, N consists of at most two components). Suppose that there exists a 3-dimensional submanifold K of N such that:

- (1) each component of K is a handlebody, and $\text{Fr}_N K$ is incompressible in N ,
- (2) $T_i \cap K$ ($i=1, 2$) consists of an annulus \mathcal{A}_i such that:
 - (i) \mathcal{A}_i is incompressible in N , and
 - (ii) \mathcal{A}_i is ∂ -incompressible in K i.e., there does not exist a properly embedded disk Δ in K such that $\Delta \cap \mathcal{A}_i$ is an essential arc in \mathcal{A}_i , and
- (3) each component of $\text{cl}(N-K)$ ($=K'$) is a handlebody, and $K' \cap T_i$ consists of an annulus \mathcal{A}'_i such that:
 - (i) \mathcal{A}'_i is incompressible in N , and
 - (ii) \mathcal{A}'_i is ∂ -incompressible in K' .

Let M be a 3-manifold obtained from $E(L)$ and N by identifying their boundaries by an orientation reversing homeomorphism such that A_i (A'_i resp.) corresponds to \mathcal{A}_i (\mathcal{A}'_i resp.). Let V (V' resp.) be the union of H and K (H' and K' resp.) in M . Then it is easy to see that V and V' are handlebodies. (In particular, if K is connected, then $\text{genus}(\partial V) = \text{genus}(\partial K) + 1$.) Hence $(V, V'; F)$ is a Heegaard splitting of M , where $F = \partial V = \partial V' (\subset M)$. For simplicity, we denote the image of H, A_i, H', A'_i in V, V' also by H, A_i, H', A'_i .

We say that a Heegaard splitting $(W, W'; G)$ is *strongly irreducible* if there does not exist a pair of essential disks D, D' in W, W' respectively such that $\partial D \cap \partial D' = \emptyset$. We note that if a Heegaard splitting is strongly irreducible, then it is irreducible [3]. Then for the above Heegaard splitting $(V, V'; F)$, we have:

Proposition 3.1. *If L is neither a trivial link nor a Hopf link, then $(V, V'; F)$ is strongly irreducible.*

Proof. Assume that $(V, V'; F)$ is not strongly irreducible, i.e. there are essential disks D, D' in V, V' respectively such that $\partial D \cap \partial D' = \emptyset$. We suppose that $\#\{D \cup (A_1 \cup A_2)\}, \#\{D' \cap (A'_1 \cup A'_2)\}$ are minimal among the ambient isotopy classes of D, D' . Then, by using standard innermost circle argument (see [6, 6.5] for example), we see that no component of $D \cap (A_1 \cup A_2), D' \cap (A'_1 \cup A'_2)$ is a circle. Then we have the following cases.

Case 1. $D \cap (A_1 \cup A_2) = \emptyset$ or $D' \cap (A'_1 \cup A'_2) = \emptyset$.

Without loss of generality, we may suppose that $D \cap (A_1 \cup A_2) = \emptyset$. Since $\text{Fr}_N K$ is incompressible in N , we see that $D \subset H$. By Lemma 2.3, we see that

D is rel $(A_1 \cup A_2)$ ambient isotopic to the disk corresponding to \mathcal{D} in Figure 2.1. Then we have the following two subcases.

Case 1-1. $D' \cap (A'_1 \cup A'_2) = \emptyset$.

In this case, by using the same argument as above, we see that $D' \subset H'$, and D' is rel $(A'_1 \cup A'_2)$ isotopic to the disk corresponding to \mathcal{D} in Figure 2.1. Since $\partial D \cap \partial D' = \emptyset$, we see that ∂D and $\partial D'$ are parallel in $H \cap \partial V$, and this immediately shows that L is a trivial link, a contradiction.

Case 1-2. $D' \cap (A'_1 \cup A'_2) \neq \emptyset$.

In this case, let $\alpha' (\subset D')$ be an outermost component of $D' \cap (A'_1 \cup A'_2)$ and $\Delta' (\subset D')$ an outermost disk such that $\text{Fr}_{D'} \Delta' = \alpha'$. Let $\beta' = \Delta' \cap \partial V'$ ($= \text{cl}(\partial \Delta' - \alpha')$). Since $\text{Fr}_N K'$ is incompressible in N and A'_i is ∂ -incompressible in K' , we see that $\Delta' \subset H'$. By the minimality of $\#\{D' \cap (A'_1 \cup A'_2)\}$, we see that Δ' is an essential disk in H' . Hence, by Proposition 2.9, we see that β' is an essential arc in $H \cap \partial V$ which joins two components of ∂A_i ($i=1$ or 2), or joins two points in a component of ∂A_i ($i=1$ or 2). Hence β' looks as in Figure 3.1 on ∂H . We easily see that this together with Proposition 2.9 shows that L is a trivial link, a contradiction.

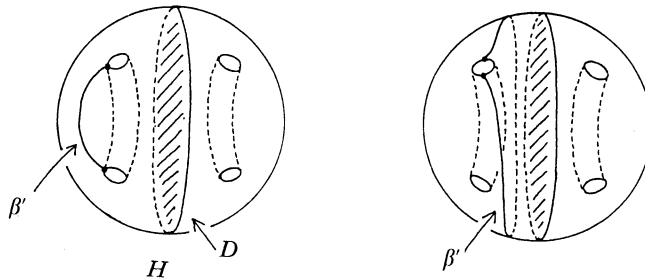

Figure 3.1

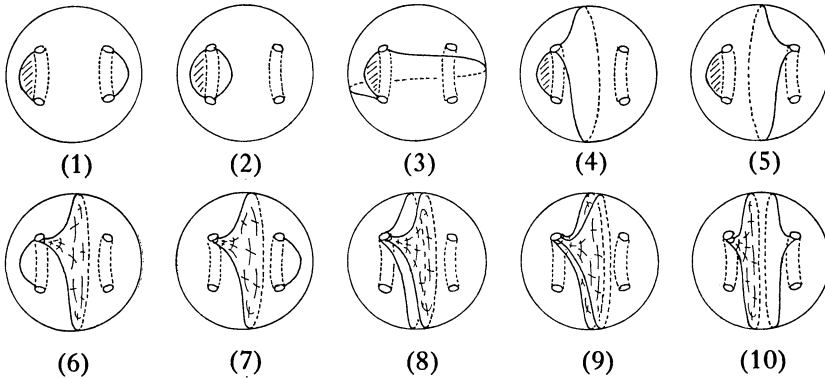

Figure 3.2

Case 2. $D \cap (A_1 \cup A_2) \neq \emptyset, D' \cap (A'_1 \cup A'_2) \neq \emptyset.$

In this case, take outermost disks Δ, Δ' in D, D' respectively as in Case 1-2. Let $\beta' = \Delta' \cap \partial V'$. Then, by using the argument in Case 1-2, we have ten possible configurations of Δ and β' (up to proper homeomorphisms of $(H, A_1 \cup A_2)$) which are described in Figure 3.2. It is easy to see that in case (3), L is a Hopf link, and in other cases L is a trivial link, a contradiction.

This completes the proof of Proposition 3.1. ■

4. Link with arbitrarily high genus free incompressible Seifert surfaces

Let L be an oriented link in the 3-sphere S^3 . A *Seifert surface* S for L is an oriented surface in S^3 such that S has no closed components, and $\partial S = L$. Then we may suppose that $S \cap E(L) = \text{cl}(S - N(\partial S; S))$, and we often abbreviate it as S . We say that S is *incompressible* if S is incompressible in $E(L)$. We say that S is *free* if $\pi_1(S^3 - S)$ is a free group. We note that if S is connected, then S is free if and only if $\text{cl}(E(L) - N(S; E(L)))$ is a handlebody (see [6] Chapter 5). We say that two Seifert surfaces S_1, S_2 for L are *weakly equivalent* if there is a self homeomorphism f of $E(L)$ such that $f(S_1) = S_2$.

For each integer $n (> 1)$, let L^n be a link as in Figure 4.1 i.e., L^n is a Pretzel link of type $P(9, -9, 7, 5, -5, -7, 5, 5, -5, -5, \dots, 5, 5, -5, -5)$.

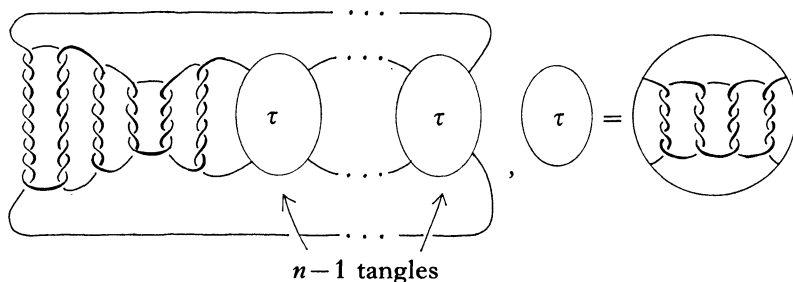

Figure 4.1

Then the purpose of this section is to prove:

Proposition 4.1. *For each integer g greater than or equal to n , L^n has $\binom{g-1}{n-1}$ free, incompressible Seifert surfaces of genus $2n+g$ (that is, of Euler characteristic $-4n-2g$) which are mutually non weakly equivalent.*

The proof of Proposition 4.1 is carried out by using the theory of incompressible branched surfaces of U. Oertel. For the terminology concerning branched surfaces, see [4], and [10]. For the proof of Proposition 4.1, we prepare one lemma.

Lemma 4.2. *Let H be an orientable handlebody of genus $g(>1)$, \mathcal{L} a union of mutually disjoint simple closed curves in ∂H . Suppose that there is a system of mutually disjoint disks $\{D_1, \dots, D_{3g-3}\}$ properly embedded in H such that*

- (1) *there does not exist a disk B in ∂H such that $\partial B = a \cup b$ where a is a subarc of \mathcal{L} , and b is a subarc of $\cup \partial D_i$, and*
- (2) *$cl(\partial H - N(\cup \partial D_i; \partial H))$ consists of $2g-2$ pants (that is, a disk with two holes) P_1, \dots, P_{2g-2} such that for each pair of boundary components of each pants P_i , there is a component of $\mathcal{L} \cap P_i$ which joins the boundary components.*

Then $cl(\partial H - N(\mathcal{L}; \partial H))$ is incompressible in H . Moreover, if D is an essential disk in H , then $\partial D \cap \mathcal{L}$ consists of more than one point.

Proof. Assume that $cl(\partial H - N(\mathcal{L}; \partial H))$ has a compressing disk E . We suppose that $\#\{E \cap (\cup D_i)\}$ is minimal among all compressing disks. By using standard innermost circle argument, we see that no component of $E \cap (\cup D_i)$ is a circle. If $E \cap (\cup D_i) = \emptyset$, then ∂E is parallel to some ∂D_i in ∂H . Hence we have $\partial E \cap \mathcal{L} \neq \emptyset$, a contradiction. Then let $\alpha(\subset E)$ be an outermost component of $E \cap (\cup D_i)$, and $\Delta(\subset E)$ an outermost disk in E such that $Fr_E \Delta = \alpha$. Let P_i be the pants which intersects $\partial \Delta$. Then, by the minimality of $\#\{\partial E \cap (\cup D_i)\}$, we see that $\beta = \partial \Delta \cap P_i$ is an essential arc in P_i . Since α is outermost, we see that $\partial \beta$ is contained in a component l of ∂P_i . Let l', l'' be other components of ∂P_i . Then there is a subarc $\gamma(\subset P_i)$ of \mathcal{L} such that γ joins l' and l'' . Hence $\beta \cap \gamma \neq \emptyset$, a contradiction, and this shows that $cl(\partial H - N(\mathcal{L}; \partial H))$ is incompressible.

Let D be an essential disk in H . We suppose that $\#\{D \cap (\cup D_i)\}$ is minimal among the proper isotopy class of D in (H, \mathcal{L}) . Then, by using standard innermost circle argument, we see that no component of $D \cap (\cup D_i)$ is a circle. If $\#\{D \cap (\cup D_i)\} = 0$, then D is parallel to some D_i in H . Hence we have $\#\{\partial D \cap \mathcal{L}\} \geq 2$, by (2). If $\#\{D \cap (\cup D_i)\} > 0$, then D contains (at least) two outermost disks Δ_1, Δ_2 . Let $\beta_i = \Delta_i \cap \partial H$ ($i=1, 2$). Then by the argument in the proof of the incompressibility of $cl(\partial H - N(\mathcal{L}; \partial H))$, we see that $\beta_i \cap \mathcal{L} \neq \emptyset$. Hence $\#\{\partial D \cap \mathcal{L}\} \geq 2$. ■

For the proof of Proposition 4.1, we first construct a branched surface which carries Seifert surfaces for L^n .

Let S be a Seifert surface for L^n as in Figure 4.2 (i), Q_1, \dots, Q_n mutually disjoint planar surfaces properly embedded in $E(L^n)$ as in Figure 4.2 (ii). Note that $S \cap Q_i$ consists of two arcs properly embedded in S . We deform $S \cup (\cup Q_i)$ in a neighborhood of $S \cap (\cup Q_i)$ as in Figure 4.3 to get a branched surface B_n .

Let $N(B_n)$, $\partial_h N(B_n)$, and $\partial_v N(B_n)$ be a fibered regular neighborhood of B_n , a horizontal boundary, and a vertical boundary respectively. Then we show:

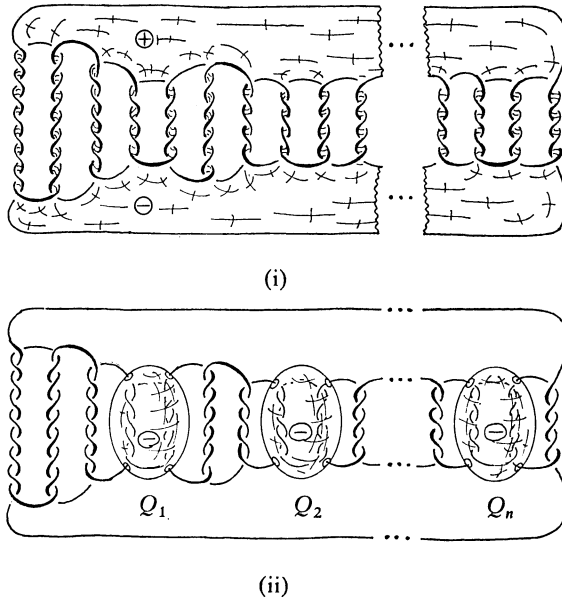

Figure 4.2

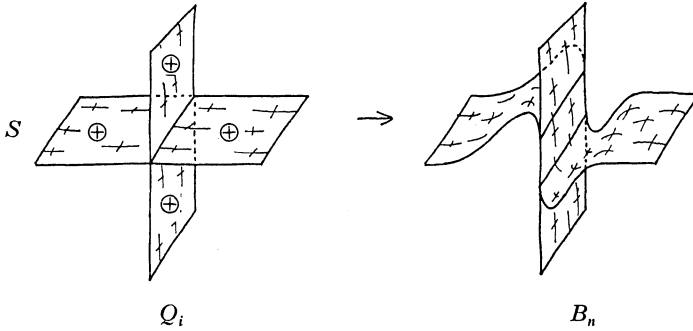

Figure 4.3

Claim 4.3. B_n is an incompressible branched surface, i.e. B_n satisfies the following three conditions.

- (1) B_n has neither a disk of contact nor a half disk of contact,
- (2) $\partial_h N(B_n)$ is incompressible and ∂ -incompressible in $cl(E(L^n) - N(B_n))$ (here a ∂ -compressing disk for $\partial_h N(B_n)$ is assumed to have boundary in $\partial E(L^n) \cup \partial_h N(B_n)$), and
- (3) there is no monogon in $cl(E(L^n) - N(B_n))$.

Proof. Let M_0, M_1, \dots, M_n be the components of $cl(E(L^n) - N(B_n))$, where M_1, \dots, M_n correspond to the insides of Q_1, \dots, Q_n . Then it is immediately ob-

served from Figures 4.2 and 4.3 that M_0 and M_i ($i=1, \dots, n$) look as in Figure 4.4. Note that $\partial_v N(B_n) \cup (\text{cl}(E(L^n) - N(B_n)) \cap \partial E(L^n))$ is a union of annuli in $\partial(M_0 \cup M_1 \cup \dots \cup M_n)$. Then the simple closed curves in Figure 4.4 denote the core curves of the annuli, where the thick parts of the simple closed curves correspond to $\partial_v N(B_n)$. We denote the union of the simple closed curves on each ∂M_i by δ_i .

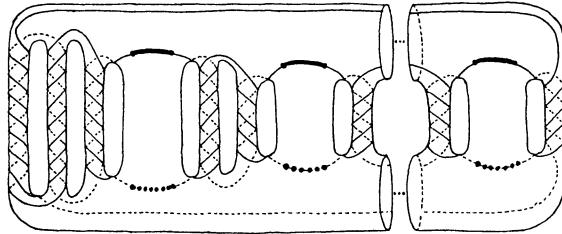

M_0 : outside of this surface

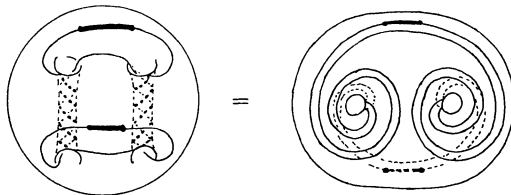

M_i

Figure 4.4

Then we have:

Subclaim. $\text{cl}(\partial M_i - N(\delta_i; \partial M_i))$ is incompressible in M_i . Moreover, if D is an essential disk in M_i , then $\partial D \cap \delta_i$ consists of more than one point.

Proof. Consider a system of disks properly embedded in M_i as in Figure 4.5. (Note that the curves in Figure 4.5 which give the outlines of ∂M_0 are also boundaries of disks.) It is immediately observed from Figure 4.4 that these disks satisfy the assumptions of Lemma 4.2 for (M_i, δ_i) . Hence we have the conclusion, and this completes the proof of Subclaim.

Now we check that B_n satisfies the above three conditions.

(1) We note that the branch locus of B_n has no self intersection. Hence if B_n has a disk of contact or a half disk of contact, then the closure of a component of $B_n - (\text{branch locus})$ is a disk Δ such that $\partial \Delta \cap (\text{branch locus})$ is $\partial \Delta$ itself

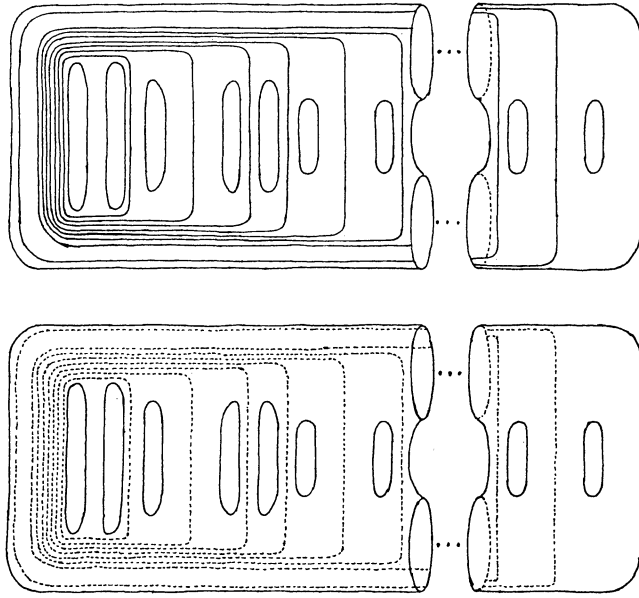

boundary curves of disks properly embedded in M_0

(i)

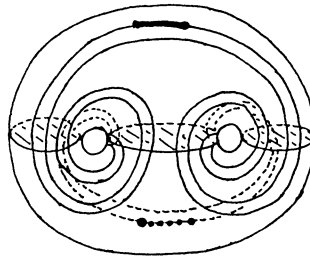

(ii)

Figure 4.5

or an arc in $\partial\Delta$. But it is easy to see from Figure 4.2 that this does not occur. Hence B_n has neither a disk of contact nor a half disk of contact.

(2) By Subclaim, we see that $\partial_h N(B_n)$ is incompressible in $\text{cl}(E(L^n) - N(B_n))$. Assume that $\partial_h N(B_n)$ has a ∂ -compressing disk Δ . Let M_i be the component of $\text{cl}(E(L^n) - N(B_n))$ which contains Δ . Since δ_i is a core curve of $M_i \cap (\partial_v N(B_n) \cup \partial E(L^n))$, we may suppose that $\Delta \cap \delta_i$ consists of a point, which is impossible by Subclaim. Hence $\partial_h N(B_n)$ is ∂ -incompressible in $\text{cl}(E(L^n) - N(B_n))$.

(3) Assume that $cl(E(L^n) - N(B_n))$ has a monogon. Then, by the argument in the above (2), we have a contradiction.

This completes the proof of Claim 4.3.

Let $(w_0, w_1, \dots, w_n, w_{n+1}, \dots, w_{2n})$ be a set of weights on B_n , where w_0 corresponds to the subsurface of S which lies outside of $Q_1 \cup \dots \cup Q_n$, w_i ($i=1, \dots, n$) corresponds to the subsurface of S which lies inside of Q_i , and w_{n+i} corresponds to Q_i . Let (m_1, \dots, m_n) be an n -tuple of positive integers, and $S(m_1, \dots, m_n)$ the surface in $E(L^n)$ which is carried by B_n with weights $(1, 1, \dots, 1, m_1, \dots, m_n)$. Then we have:

Claim 4.4. $S(m_1, \dots, m_n)$ is a free incompressible Seifert surface for L_n .

Proof. By Claim 4.3 and [4], we see that $S(m_1, \dots, m_n)$ is incompressible. It is easy to see that $S(m_1, \dots, m_n)$ can be expressed as in Figure 4.6, and this immediately shows that $S(m_1, \dots, m_n)$ is free.

Claim 4.5. $S(m_1, \dots, m_n)$ and $S(m'_1, \dots, m'_n)$ are weakly equivalent if and only if $m_i = m'_i$ for each i .

Proof. We first show:

Subclaim 1. Each component of $cl(E(L^n) - N(B_n))$ does not have a product structure, i.e., $(M_i, N(\delta_i; \partial M_i))$ is not homeomorphic to $(F \times I, \partial F \times I)$ for any surface F .

Proof. By Figure 4.4, we see that $cl(\partial M_i - N(\delta_i; \partial M_i))$ consists of two components which have mutually different Euler characteristics. Hence $(M_i, N(\delta_i; \partial M_i))$ does not have a product structure.

Then we show:

Subclaim 2. Let h be a homeomorphism from $E(L^n)$ to itself. Then h extends to a homeomorphism from S^3 to itself, i.e., h induces an element \bar{h} of $\text{Homeo}(S^3, L^n)$.

Proof. Let l_1, l_2 be the components of L^n . Then it is easy to see that each l_i is a trivial knot. Hence if m ($\subset \partial E(L^n)$) is a meridian of L^n then

(*) we get a solid torus from $E(L^n)$ by attaching a solid torus with framing m .

Since the linking number of l_1 and l_2 is zero, we see that by [11] 5.1 Theorem, for each component of $\partial E(L^n)$ the simple loops with this property (*) are unique up to orientations and isotopies. Hence $h(m)$ is also a meridian of L^n ,

and this shows that h extends to a homeomorphism from S^3 to itself.

Subclaim 1 with [10] Theorem 1 shows that $S(m_1, \dots, m_n)$ and $S(m'_1, \dots, m'_n)$ are mutually isotopic if and only if $m_i = m'_i$ for each i . Then, by [1], we see that $\text{Homeo}(S^3, L^n) \cong \mathbb{Z}_2$ where the non-trivial element is represented by the involution ϕ of Figure 4.6. Then, by Subclaim 2, we see that $\text{Homeo}(E(L^n)) \cong \mathbb{Z}_2$, where the non-trivial element is represented by the restriction of ϕ to $E(L^n)$, and we denote the element also by ϕ . It is clear that $\phi(S(m_1, \dots, m_n))$ is isotopic to $S(m_1, \dots, m_n)$. Hence we see that $S(m_1, \dots, m_n)$ is weakly equivalent to $S(m'_1, \dots, m'_n)$ if and only if $m_i = m'_i$ for each i .

This completes the proof of Claim 4.5. ■

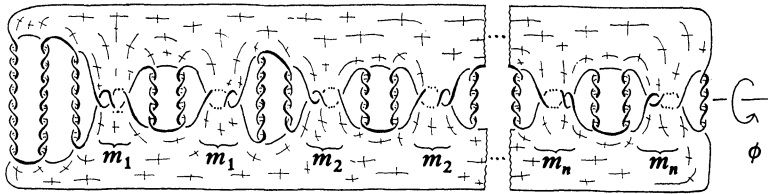

Figure 4.6

Proof of Proposition 4.1. It is easy to see that the genus of $S(m_1, \dots, m_n)$ is $2n + (m_1 + \dots + m_n)$. Let S_g be the set of n -tuple of positive integers (m_1, \dots, m_n) such that $m_1 + \dots + m_n = g$. Then it is elementary to show that S_g consists of $\binom{g-1}{n-1}$ elements. Hence by Claims 4.4, and 4.5 we see that L^n has $\binom{g-1}{n-1}$ mutually non-weakly equivalent, free, incompressible Seifert surfaces of genus $2n + g$.

This completes the proof of Proposition 4.1. ■

5. Proof of Theorem

In this section, we prove Theorem stated in section 1. Let $L^n = l_1^n \cup l_2^n$ be the link in section 4, and $L = l_1 \cup l_2$ a two bridge link. Let $f: \partial E(L) \rightarrow \partial E(L^n)$ be an orientation reversing homeomorphism such that f maps a meridian of l_i to a longitude of l_i^n (note that since the linking number of l_1^n and l_2^n is zero, a longitude of l_i^n is well defined), and $M = E(L) \cup_f E(L^n)$. For the proof of Theorem, we prove some lemmas and a proposition.

Let H, A_1, A_2, \mathcal{D} , and P be as in section 2 (see Figure 2.1).

Lemma 5.1. *Let A be an incompressible annulus properly embedded in (H, P) such that A is not parallel to an annulus in P . Then A is parallel to either A_1 or A_2 .*

Proof. If $A \cap \mathcal{D} = \emptyset$, then A is contained in a component of $\text{cl}(H -$

$N(\mathcal{D}; H)$), which is a solid torus. Hence it is easy to see that A is parallel to either A_1 or A_2 . Suppose that $A \cap \mathcal{D} \neq \emptyset$. By using the arguments in the proof of Lemma 2.3, we may suppose that no component of $A \cap \mathcal{D}$ is an inessential circle or an inessential arc in A . Since A is incompressible, we see that no component of $A \cap \mathcal{D}$ is an essential circle in A . Hence we may suppose that each component of $A \cap \mathcal{D}$ is an essential arc in A . Let $\alpha(\subset \mathcal{D})$ be an outermost component of $A \cap \mathcal{D}$, and $\Delta(\subset \mathcal{D})$ an outermost disk such that $\text{Fr}_{\mathcal{D}} \Delta = \alpha$. Then by ∂ -compressing A along Δ , we get a disk properly embedded in (H, P) . Since A is not parallel to an annulus in P , ∂D is essential in P . Hence ∂D is essential in ∂H . Then, by Lemma 2.3, we see that D is properly isotopic to \mathcal{D} in (H, P) . Hence A is properly isotopic in (H, P) to an annulus obtained from \mathcal{D} by adding a band, and this immediately shows that A is parallel to either A_1 or A_2 . ■

By using similar arguments, we can prove the following two lemmas, and the proofs are left to the reader.

Lemma 5.2. *Let A be an incompressible annulus properly embedded in H such that one component of ∂A is contained in $A_1 \cup A_2$, and the other component is contained in P . Then A is parallel to an annulus in ∂H .*

Lemma 5.3. *Let A be an incompressible annulus properly embedded in $(H, A_1 \cup A_2)$. Then A is parallel to an annulus in $A_1 \cup A_2$ (hence $\partial A \subset A_1$ or $\partial A \subset A_2$).*

See Figure 5.1.

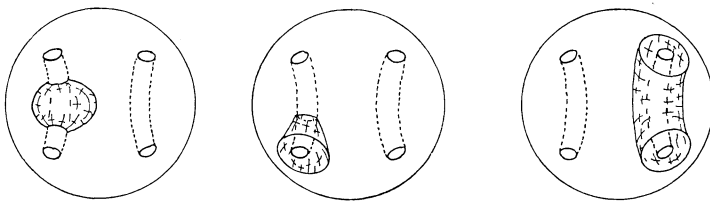

Figure 5.1

Let S be a free, incompressible Seifert surface for L^n . Since the linking number of l_1^n and l_2^n is zero, we see that $S \cap \partial N(l_i^n; S^3)$ is a longitude of l_i^n . Hence, by regarding $E(L^n)$ as N , $N(S; E(L^n))$ as K in section 3 (by section 4, it is easy to see that these N, K satisfy the conditions (1), (2), and (3) of section 3), we get a Heegaard splitting $(V_1, V_2; F)$ of M . Let S' be another free, incompressible Seifert surface for L^n , and $(V'_1, V'_2; F')$ a Heegaard splitting of M obtained from S' as above. Then we show:

Proposition 5.4. *Suppose that L is not a $(2, 2n)$ torus link. If the Heega-*

and splittings $(V_1, V_2; F)$ and $(V'_1, V'_2; F')$ are homeomorphic, i.e. there is a homeomorphism $h: M \rightarrow M$ such that $h(F) = F'$, then S and S' are weakly equivalent.

Proof. Let T^1, T^2 be the incompressible tori in M corresponding to $\partial N(l_1; S^3), \partial N(l_2; S^3)$. By [1], L^* is a hyperbolic link. Hence $T^1 \cup T^2$ gives a torus decomposition of M . Let $A_j^i = T^i \cap V_j, A_j^{i'} = T^i \cap V'_j$ ($i, j = 1, 2$), H_i (H'_j resp.) the closure of the component of $V_j - (A_j^1 \cup A_j^2)$ ($V'_j - (A_j^{1'} \cup A_j^{2'})$ resp.) which is contained in $E(L)$, and K_j (K'_j resp.) the closure of $V_j - H_j$ ($V'_j - H'_j$ resp.). Then $h(V_1) = V'_j$ ($j = 1$ or 2).

Claim. $h(\partial A_1^1 \cup \partial A_1^2)$ is isotopic in F' to a 1-manifold disjoint from $\partial A_j^{1'} \cup \partial A_j^{2'}$.

Proof. Assume that Claim does not hold. Without loss of generality, we may suppose that $h(\partial A_1^1)$ is not isotopic in F' to a 1-manifold disjoint from $\partial A_j^{1'} \cup \partial A_j^{2'}$. We suppose that $\# \{h(\partial A_1^1) \cup (\partial A_j^{1'} \cup \partial A_j^{2'})\}$ is minimal in its isotopy class in F' . Then let A'_1 (A'_2 resp.) be the element of $\{h(A_1^1), h(A_2^2)\}$ which is contained in V'_1 (V'_2 resp.). By using standard innermost circle argument, we may suppose that no component of $A'_1 \cap (A_1^{1'} \cup A_1^{2'})$ ($A'_2 \cap (A_2^{1'} \cup A_2^{2'})$ resp.) is an inessential simple closed curve in A'_1 (A'_2 resp.). Then we have the following three cases.

Case 1. There exist components α_1, α_2 of $A'_1 \cap (A_1^{1'} \cup A_1^{2'})$, $A'_2 \cap (A_2^{1'} \cup A_2^{2'})$ respectively such that α_1, α_2 are inessential arcs in A'_1, A'_2 .

In this case, by using the same arguments in the proof of Proposition 3.1 Case 2, we see that L is either a trivial link ($(: (2, 0)$ torus link) or a Hopf link ($(: (2, 2)$ torus link), a contradiction.

Case 2. There exists a component α of $A'_1 \cap (A_1^{1'} \cup A_1^{2'})$ such that α is an inessential arc in A'_1 and each component of $A'_2 \cap (A_2^{1'} \cup A_2^{2'})$ is an essential arc in A'_2 .

For the proof of this case, we prepare one claim.

Subclaim. There exists a component E' of $A'_2 \cap H'_2$ such that E' is an essential disk in H'_2 .

Proof. Let E be a component of $A'_2 \cap H'_2$ (hence $E \cap (A_2^{1'} \cup A_2^{2'})$ consists of two arcs). If a component of $E \cap (A_2^{1'} \cup A_2^{2'})$ is an essential arc in $A_2^{1'} \cup A_2^{2'}$, then, by Lemmas 2.6 and 2.7, we see that E is an essential disk in H'_2 . Hence we suppose that each component of $E \cap (A_2^{1'} \cup A_2^{2'})$ is an inessential arc in $A_2^{1'} \cup A_2^{2'}$ for each component E of $A'_2 \cap H'_2$. Assume that every component of $A'_2 \cap H'_2$ is an inessential disk in H'_2 . Let E^* be a component of $A'_2 \cap K'_2, \alpha_1^*, \alpha_2^*$ the components of $E^* \cap (A_2^{1'} \cup A_2^{2'})$, and Δ_1^*, Δ_2^* the disks in $A_2^{1'} \cup A_2^{2'}$ such that $\text{Fr}_{A_2^{1'} \cap A_2^{2'}} \Delta_i^*$

$=\alpha_i^*$ ($i=1, 2$). By the minimality of $\partial A_2' \cap (\partial A_1^{1'} \cup \partial A_2^{2'})$ and the incompressibility of $\text{Fr}_N K$, we see that $\Delta_1^* \cap \Delta_2^* = \emptyset$. Let D^* be a disk properly embedded in K_2' obtained from $E^* \cup (\Delta_1^* \cup \Delta_2^*)$ by pushing its interior to the interior of K_2' . Then, by the incompressibility of $\text{Fr}_N K$, we see that D^* is ∂ -parallel. Hence E^* is ∂ -parallel in K_2' . Hence every component of $A_2' \cap K_2'$ is ∂ -parallel in K_2' and this shows that A_2' is ∂ -parallel in V_2' , a contradiction.

By Subclaim, Propositions 2.9, 2.10, and the argument of the proof of Proposition 3.1, we have nine possible configurations of a component Δ of $A_1' \cap H_1'$ and a component β' of $E' \cap \partial V_2'$ up to proper homeomorphisms of $(H_1', A_1^{1'} \cup A_2^{2'})$. See Figures 3.2 (1)-(3), (6), (7) and 5.2. In each case of Figure 5.2, we easily see that L is a $(2, 2n)$ torus link, a contradiction.

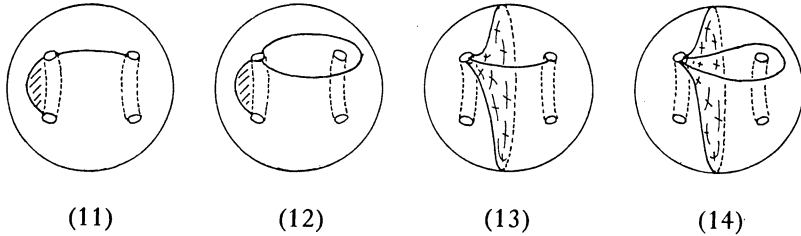

Figure 5.2

Case 3. Each component of $A_1' \cap (A_1^{1'} \cup A_2^{2'})$ ($A_2' \cap (A_2^{1'} \cup A_2^{2'})$ resp.) is an essential arc in A_1' (A_2' resp.).

Suppose that some component of $A_1' \cap (A_1^{1'} \cup A_2^{2'})$ or $A_2' \cap (A_2^{1'} \cup A_2^{2'})$ is an inessential arc in A_1' or A_2' . Then by regarding h^{-1} as h , we see that L is a $(2, 2n)$ torus link by Case 1 or 2. Hence we may suppose that the components of $A_1' \cap (A_1^{1'} \cup A_2^{2'})$, $A_2' \cap (A_2^{1'} \cup A_2^{2'})$ are essential arcs in A_1' , A_2' . Then, by Lemma 2.6, we see that each component of $A_1' \cap H_1'$ ($A_2' \cap H_2'$ resp.) is either one of the disks in Figure 2.5. Let E_1 be a component of $A_1' \cap H_1'$, E_2 a component of $A_2' \cap H_2'$ such that $E_1 \cap E_2 \neq \emptyset$, and α a component of $E_1 \cap E_2$. Then by Proposition 2.10 α looks as in Figure 2.12 (i) or (iii) on both H_1' and H_2' , and this immediately shows that L is a $(2, 2n)$ torus link, a contradiction.

This completes the proof of Claim.

By Claim, we can deform h by a proper isotopy in the mapping class $(M, F) \rightarrow (M, F')$ to h_1 such that $h_1(\partial A_1^1 \cup \partial A_1^2) \cap (\partial A_1^{1'} \cup \partial A_2^{2'}) = \emptyset$. Then, by using standard innermost circle argument, we see that h_1 is rel V_2 isotopic to h_2 such that no component of $h_2(A_1^1 \cup A_1^2) \cap (A_1^{1'} \cup A_2^{2'})$ is an inessential simple closed curve (hence each component of $h_2(A_1^1 \cup A_1^2) \cap (A_1^{1'} \cup A_2^{2'})$ is (if exists) an essential simple closed curve). Then, by Lemmas 5.1, 5.2, and 5.3, we see that h_2 is properly isotopic in the mapping class $(M, F) \rightarrow (M, F')$ to h_3 such that $h_3(A_1^1 \cup A_1^2) \subset$

K'_j . Since $h_3(H_1 \cap \partial V_1)$ is homeomorphic to $H'_j \cap \partial V'_j$, this shows that $h_3(\partial A_1^1 \cup \partial A_1^2)$ is parallel to $\partial A_j^{1'} \cup \partial A_j^{2'}$ in F' . Then, by applying the same arguments as above, we see that h_3 is rel V_1 isotopic to h_4 such that $h_4(A_2^1 \cup A_2^2) \cap (A_k^{1'} \cup A_k^{2'}) = \emptyset$ (where $k \neq j$), hence $h_4(T^1 \cup T^2) \cap (T^1 \cup T^2) = \emptyset$. Then, by the uniqueness of the torus decomposition [7, IX.12], we see that $h_4(A_1^1 \cup A_1^2)$ and $A_j^{1'} \cup A_j^{2'}$ ($h_4(A_2^1 \cup A_2^2)$ and $(A_k^{1'} \cup A_k^{2'})$ resp.) are parallel in V'_j (V'_k resp.). Hence h_4 is properly isotopic in the mapping class $(M, F) \rightarrow (M, F')$ to h_5 such that $h_5(T^1 \cup T^2) = T^1 \cup T^2$. Hence $h_5(E(L^n)) = E(L^n)$, and $h_5(K_1) = K'_j$. Since S (S' resp.) is parallel to a component of $\text{Fr}_{E(L^n)} K_1$ ($\text{Fr}_{E(L^n)} K'_j$ resp.), we see that S and S' are weakly equivalent.

This completes the proof of Proposition 5.4. ■

Proof of Theorem. Let M be as above. We suppose that L is a hyperbolic two bridge link (for example, L is a Whitehead link). Suppose that the genus of S is $2n+g$. Then it is easy to see that the genus of the Heegaard splitting $(V_1, V_2; F)$ is $4n+2+2g$. Hence, by Propositions 3.1, 4.1, and 5.4, we see that M has mutually non homeomorphic $\binom{g-1}{n-1}$ strongly irreducible Heegaard splittings of genus $4n+2+2g$. Since there are infinitely many hyperbolic two bridge links, we see, by the uniqueness of torus decomposition, that there are infinitely many 3-manifolds with this property. If $g > n$, then these Heegaard splittings are not of minimal genus. Hence M admits (at least one) reducible Heegaard splitting of genus $4n+2+2g$, and we have $h_M(4n+2+2g) > \binom{g-1}{n-1}$.

This completes the proof of Theorem. ■

References

- [1] M. Boileau and B. Zimmermann: *Symmetries of nonelliptic Montesinos links*, Math Ann. **277** (1987), 563–584.
- [2] G. Burde and H. Zieschang: *Knots*, Studies in Math. 5, Walter de Gruyter, 1985.
- [3] A. Casson and C. McA Gordon: *Reducing Heegaard splittings*, Topology and its appl. **27** (1987), 275–283.
- [4] W. Floyd and U. Oertel: *Incompressible surface via branched surfaces*, Topology **23** (1984), 117–125.
- [5] C. Gordon: "Talk at Brigham Young University," 1985.
- [6] J. Hempel: *3-manifolds*, Ann. of Math. Studies 86, Princeton Univ. Press, 1976.
- [7] W. Jaco: *Lectures on three manifold topology*, CBMS Regional Conf. Ser. in Math. No. 43, 1980.
- [8] K. Johannson: *Heegaard surfaces in Haken 3-manifolds*, Bull. AMS **23** (1990), 91–98.

- [9] K. Johansson: *Computations in 3-manifolds*, preprint.
- [10] U. Oertel: *Incompressible branched surfaces*, *Invent. Math.* **76** (1984), 385–410.
- [11] M. Scharlemann: *Sutured manifolds and generalized Thurston norms*, *J. Diff. Geom.* **29** (1989), 557–614.
- [12] F. Waldhausen: *Some problems on 3-manifolds*, *Proc. Symp. in Pure Math.* **32** (1978), 313–322.

Department of Mathematics,
Osaka University,
Toyonaka. Osaka, 560
Japan