

## LOGARITHMIC DEL PEZZO SURFACES OF RANK ONE WITH CONTRACTIBLE BOUNDARIES

DE-QI ZHANG

(Received February 4, 1987)

### Contents

#### Introduction

1. Preliminaries
2. The decomposition of  $D$
3. Structure theorem in the case  $|C+D+K_V| \neq \phi$
4. Preparations for the case  $|C+D+K_V| = \phi$
5. Structure theorem in the case  $|C+D+K_V| = \phi$ , the part (I)
6. Structure theorem in the case  $|C+D+K_V| = \phi$ , the part (II)
7. Normal surfaces  $P^2/G$

**Introduction.** Let  $k$  be an algebraically closed field of characteristic zero. Consider a pair  $(V, D)$  where  $V$  is a nonsingular projective rational surface and  $D$  is a reduced effective divisor with only simple normal crossings. We employ the terminology and notations in MT [7 and 8]. By MT [7; Lemma 2.1], there exists a birational morphism  $u: (V, D) \rightarrow (\tilde{V}, \tilde{D})$  such that  $u_*D = \tilde{D}$ ,  $(\tilde{V}, \tilde{D})$  is almost minimal and  $\bar{\kappa}(V-D) = \bar{\kappa}(\tilde{V}-\tilde{D})$ . In particular, if  $\tilde{V}-\tilde{D}$  is affine-ruled, so is  $V-D$ . The divisor  $D+K_V$  can be decomposed into  $D+K_V = (D^\sharp+K_V) + Bk(D)$  (cf. MT [7; §1.5]). Suppose hereafter that  $(V, D)$  is almost minimal. Then  $\bar{\kappa}(V-D) \geq 0$  iff  $D^\sharp+K_V$  is numerically effective (cf. MT [7; §1.12]). In this case  $D+K_V = (D^\sharp+K_V) + Bk(D)$  is nothing but the Zariski decomposition.

By Theorem 2.11 in MT [7] and by Main Theorem and Theorem 7 in MT [8], on the case where  $\bar{\kappa}(V-D) = -\infty$ ,  $V-D$  is affine-uniruled except the unknown case where  $(V, D)$  is a logarithmic del Pezzo surface of rank one with contractible boundaries (cf. Definition 1.1 below). Professor M. Miyanishi conjectured

**Conjecture (1)** (the weaker form). If  $(V, D)$  is a log del Pezzo surface of rank one with contractible boundaries then  $V-D$  is affine-uniruled.

**Conjecture (2)**. Let  $(V, D)$  be the same as in the conjecture (1). Then there exists a finite subgroup  $G$  of  $\text{PGL}(2, k) = \text{Aut}_k(P^2)$  such that  $\tilde{V}$  is isomor-

phic to  $\mathbf{P}^2/G$ , where  $g: V \rightarrow \bar{V}$  is the contraction of all connected components of  $D$  and in fact,  $g$  is a minimal resolution of singularities on  $\bar{V}$ .

Although the conjecture (2) implies the conjecture (1), our joint work with M. Miyanishi shows that the conjecture (2) is false (cf. [12; forthcoming]). To attack them, some work has been done in the unpublished notes of Miyanishi [5]. On the other hand, we defined in Zhang [11] an Iitaka surface and classified all of them. This class of surfaces will play an essential role in the subsequent arguments. Let  $(V, D)$  be a log del Pezzo surface of rank one with contractible boundaries. By definition,  $-(D^\# + K_V)$  ( $\neq 0$ ) is numerically effective. We fix an irreducible curve  $C$  on  $V$  such that  $-(C, D^\# + K_V)$  attains the smallest positive value. In §3, we classify all log del Pezzo surfaces  $(V, D)$  of rank one with contractible boundaries and with  $|C + D + K_V| \neq \emptyset$ . We also proved:

**Theorem 3.6.** *Let  $(V, D)$  be a log del Pezzo surface of rank one with contractible boundaries. Suppose that every connected component of  $D$  is contractible to a Gorenstein quotient singularity. Then  $V - D$  is affine-uniruled.*

Let the pair  $(V, D)$  be as in the conjecture (1) above. In §§5 and 6 we proved that  $V - D$  is affine-uniruled provided that  $|C + D + K_V| = \emptyset$  and some additional conditions on the configuration of  $C + D$ .

In §7, we consider normal surfaces  $\mathbf{P}^2/G$  with a finite subgroup  $G$  of  $\text{PGL}(2, k)$ . Let  $g: V \rightarrow \mathbf{P}^2/G$  be a minimal resolution such that  $D := g^{-1}(\text{Sing } \mathbf{P}^2/G)$  has only simple normal crossings. Then  $(V, D)$  is a log del Pezzo surface of rank one with contractible boundaries (cf. Proposition 7.1). We give some examples of normal surfaces  $\mathbf{P}^2/G$  in §7.

I would like to express my gratitude to Professor M. Miyanishi for showing me the notes [5] and giving me very useful suggestion. I also thank Professor S. Tsunoda for helpful comments.

TERMINOLOGY. The terminology is the same as the one in MT [7 and 8]. For example, the definitions of almost minimal models, rods, twigs, forks,  $Bk(D)$ , etc. are found there. By a  $(-n)$  curve we mean a nonsingular rational curve with self-intersection number  $(-n)$ . A reduced effective divisor  $D$  is called an SNC divisor (an NC divisor, resp.) if  $D$  has only simple normal crossings (normal crossings, resp.).  $V - D$  is said to be affine-ruled (affine-uniruled, resp.) if there is an open immersion (a dominant morphism, resp.)  $\phi: A^1 \times U \rightarrow V - D$  where  $U$  is an affine curve.

NOTATIONS.

- $K_V$ : the canonical divisor on  $V$ .
- $\bar{\kappa}(V - D)$ : the logarithmic Kodaira dimension of an open surface  $V - D$ .
- $\rho(V)$ : the Picard number of  $V$ .
- $\Phi_{|C|}$ : the rational map defined by a complete linear system  $|C|$ .

- $\Sigma_n(n \geq 0)$ : a Hirzebruch surface of degree  $n$ .
- $D^\sharp$ : =  $D - Bk(D)$ .
- $\#D$ : the number of all irreducible components in  $D$ .
- $h^i(D)$ : =  $\dim H^i(V, D)$ .

**1. Preliminaries**

We work in this paper on an algebraically closed field  $k$  of characteristic zero. Let  $V$  be a nonsingular projective rational surface over  $k$  and let  $D$  be a reduced effective divisor with simple normal crossings (SNC, for short).

DEFINITION 1.1. A pair  $(V, D)$  is called a log del Pezzo surface of rank one with contractible boundaries if the following conditions are met:

- (1) each connected component of  $D$  is contractible to a normal point with quotient singularity; in other words,  $\text{Supp } Bk(D) = \text{Supp}(D)$  (for the definition of  $Bk(D)$ , see MT [7]); there are no  $(-1)$  curves in  $D$ ;
- (2) the anti-canonical divisor  $-K_V$  is ample and is a generator of  $NS(\bar{V})_{\mathbb{Q}}$ , which is isomorphic to  $\mathbb{Q}$ , where  $g: V \rightarrow \bar{V}$  is the contraction of all connected components of  $D$ .

REMARK 1.2. (1) If  $(V, D)$  is a log del Pezzo surface of rank one with contractible boundaries then  $(V, D)$  is almost minimal; for the definition of "almost minimal" we refer to MT [7]. Indeed, suppose that  $H$  is an irreducible curve on  $V$  such that  $(H, D^\sharp + K_V) < 0$  and the intersection matrix of  $H + Bk(D)$  is negative definite. Find a  $\mathbb{Q}$ -divisor  $D(H)$  on  $V$  such that  $\text{Supp } D(H) \subseteq \text{Supp } Bk(D)$  and that  $(D(H), D_i) = -(H, D_i)$  for any component  $D_i$  of  $\text{Supp } Bk(D) = \text{Supp}(D)$ . Since  $\rho(\bar{V}) = 1$ , we have  $(g_*H)^2 \geq 0$ , while  $(g_*H)^2 = (g^*g_*H)^2 = (H + D(H))^2 < 0$ . This is absurd.

(2) The conditions (1) and (2) in Definition 1.1 are equivalent to the condition (1) in Definition 1.1 and the following condition

$$(2)' \quad \rho(\bar{V}) = 1 \quad \text{and} \quad \bar{\kappa}(V - D) = -\infty .$$

At first, we assume the conditions (1) and (2) in Definition 1.1. We must show that  $h^0(V, n(D + K_V)) = 0$  for any integer  $n > 0$ . Suppose, on the contrary, that  $h^0(V, n_0(D + K_V)) > 0$  for some  $n_0 > 0$ . Replacing  $n_0$  by its multiple we may assume that  $n_0(D^\sharp + K_V)$  is an integral divisor. Then  $h^0(V, n_0(D^\sharp + K_V)) = h^0(V, n_0(D + K_V)) > 0$  by [7; Lemma 1.10]. Take an ample divisor  $H$  on  $V$ . On the one hand,  $(H, n_0(D^\sharp + K_V)) \geq 0$  for  $|n_0(D^\sharp + K_V)| \neq \emptyset$ . On the other hand, since  $-(D^\sharp + K_V) (\neq 0)$  is a numerically effective divisor on  $V$ , we have  $(H, n_0(D^\sharp + K_V)) < 0$  by Kleiman's criterion. This is a contradiction. So, the condition (2)' is met. Next, we assume the conditions (1) and (2)'. Since  $\rho(\bar{V}) = 1$ ,  $(D^\sharp + K_V)^2 = (g^*K_{\bar{V}})^2 \geq 0$ . We claim that  $(D^\sharp + K_V)^2 > 0$ . Indeed, suppose, on the contrary,

that  $(D^\sharp + K_V)^2 = 0$ . Then  $(K_V^2) = 0$  and  $K_V \equiv 0$ . Hence  $D^\sharp + K_V \equiv g^*K_{\bar{V}} \equiv 0$ . Since  $V$  is rational, there exists an integer  $m > 0$  such that  $m(D^\sharp + K_V) \sim 0$  as an integral divisor. So,  $|m(D + K_V)| \supseteq |m(D^\sharp + K_V)| + m(D - D^\sharp) \neq \emptyset$ , which is a contradiction to  $\bar{\kappa}(V - D) = -\infty$ . Thus  $(D^\sharp + K_V)^2 > 0$ . Since  $\rho(\bar{V}) = 1$ ,  $K_{\bar{V}}$  or  $-K_{\bar{V}}$  is ample. We assert that  $-K_{\bar{V}}$  is ample. Suppose that the assertion is false. Then  $K_{\bar{V}}$  is ample. So,  $D^\sharp + K_V \equiv g^*K_{\bar{V}}$  is numerically effective and  $(D^\sharp + K_V)^2 > 0$ . Take  $n \gg 0$  such that  $n(D^\sharp + K_V)$  is an integral divisor. Then  $h^2(V, n(D^\sharp + K_V)) = h^2(V, K_V - n(D^\sharp + K_V)) = 0$ . Indeed, if there is an effective divisor  $\Delta$  with  $\Delta \sim K_V - n(D^\sharp + K_V)$ , taking an ample divisor  $H$ , we have  $(H, D^\sharp + K_V) > 0$  by Kleiman's criterion and  $0 \leq (H, \Delta) = (H, K_V - n(D^\sharp + K_V)) < 0$  for  $n \gg 0$ . This is absurd. By the Riemann-Roch theorem, we have  $h^2(V, n(D^\sharp + K_V)) \geq \frac{n^2}{2}(D^\sharp + K_V)^2 - \frac{n}{2}(D^\sharp + K_V, K_V) + 1 > 0$  if  $n \gg 0$ . This implies  $\bar{\kappa}(V - D) \geq 0$ , a contradiction.

This Remark is due to Miyanishi [5].

Since  $-(D^\sharp + K_V)$  is, by the definition, numerically equivalent to  $-g^*(K_{\bar{V}})$ ,  $-(D^\sharp + K_V)$  is numerically effective, where  $D^\sharp := D - Bk(D)$ , i.e.,  $-(A, D^\sharp + K_V) \geq 0$  for any irreducible curve  $A$ ; furthermore,  $-(A, D^\sharp + K_V) = 0$  iff  $A \leq D$ . We also have  $\rho(V) = \#D + 1$ , where  $\#D$  is the number of all irreducible components in  $D$ .

We give some lemmas as preparations.

**Lemma 1.3.** *Every  $(-a)$  curve  $A$  with  $a \geq 2$  is in  $D$ , where a  $(-a)$  curve  $A$  means a nonsingular rational curve with  $(A^2) = (-a)$ .*

Proof. Suppose  $A \not\leq D$ . Then  $0 < -(A, D^\sharp + K_V) \leq -(A, K_V) = 2 + (A^2) \leq 0$ , a contradiction. Q.E.D.

In the following lemma, we only use the fact that  $\rho(V) = \#D + 1$ .

**Lemma 1.4.** *There is no  $(-1)$  curve  $E$  such that, after contracting some  $(-1)$  curves and consecutively (smoothly) contractible curves in  $E + D$ ,  $E + D$  becomes a union of admissible rational rods and forks; "admissible" means that each irreducible component of the image of  $E + D$  has self-intersection number  $\leq -2$ .*

Proof. Suppose that there exists a  $(-1)$  curve  $E$  and a contraction  $u: V \rightarrow W$  of some  $(-1)$  curves and consecutively (smoothly) contractible curves in  $E + D$  so that  $u_*(E + D)$  is admissible;  $u$  must be composed with the contraction of  $E$ . Let  $h: W \rightarrow \bar{W}$  be the contraction of  $u_*(E + D) = u_*D$ . Then  $\#D + 1 = \rho(V) = \rho(W) + 1 + m = \#u_*D + \rho(\bar{W}) + 1 + m = \#D + 1 + \rho(\bar{W}) \geq \#D + 2$ , where  $m$  is the number of all irreducible components in  $D$  contracted by  $u$ . This is a contradiction. Q.E.D.

In Lemma 1.5, (2) and (3) below, the result has nothing to do with  $D$ , so it holds generally.

**Lemma 1.5.** *Assume  $\Phi: V \rightarrow \mathbf{P}^1$  is a  $\mathbf{P}^1$ -fibration. Then the following assertions hold:*

- (1)  $\#\{\text{irreducible components of } D \text{ not in any fiber of } \Phi\} = 1 + \sum_f \#\{(-1) \text{ curves in } f\} - 1$ , where  $f$  moves over all singular fibers of  $\Phi$ .
- (2) If  $E$  is a unique  $(-1)$  curve in a fiber  $f$  then  $E$  has coefficient in  $f$  more than one.
- (3) If a singular fiber  $f$  consists only of  $(-1)$  curves and  $(-2)$  curves then  $f$  has one of the following graphs:

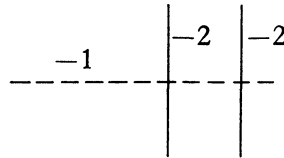

(i)

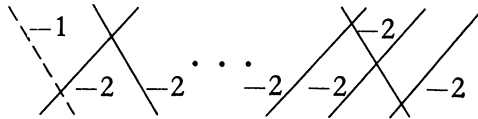

(ii)

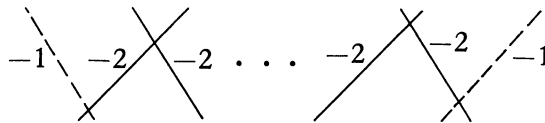

(iii)

Picture (1)

where the integer over a curve is the self-intersection number of the corresponding curve. In particular, the sum of the coefficients of all  $(-1)$  curves in  $f$  is two.

**Proof.** (1) By Lemma 1.3, every singular fiber  $f$  consists of  $(-1)$  curves and irreducible components of  $D$ . Let  $u: V \rightarrow \sum_n (n \geq 0)$  be the contraction of

all  $(-1)$  curves and consecutively (smoothly) contractible curves in fibers, where  $\Sigma_n$  is the Hirzebruch surface of degree  $n$ . Then  $\#D+1=\rho(V)=2+\#\{(-1)$  curves and irreducible components of  $D$  in fibers to be contracted by  $u\}$ . Thence the assertion (1) easily follows.

As for the assertions (2) and (3), we contract  $(-1)$  curves and consecutively (smoothly) contractible curves in a fiber  $f$  one by one, and the assertions can be verified inductively. Q.E.D.

In the following lemma, the assertions (1) and (2) hold generally.

**Lemma 1.6.** *Let  $\Phi: V \rightarrow \mathbb{P}^1$  be a  $\mathbb{P}^1$ -fibration and let  $f$  be a singular fiber of  $\Phi$ . Then we have the following assertions.*

(1) *If  $f$  consists of  $(-1)$  curves,  $(-2)$  curves and one  $(-3)$  curve, then  $f$  has one of the following configurations:*

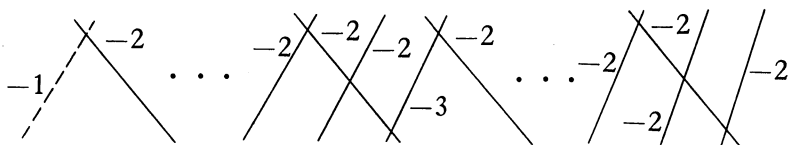

(i)

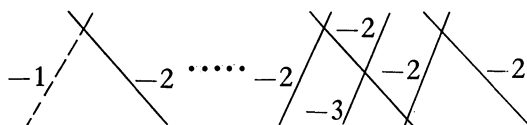

(ii)

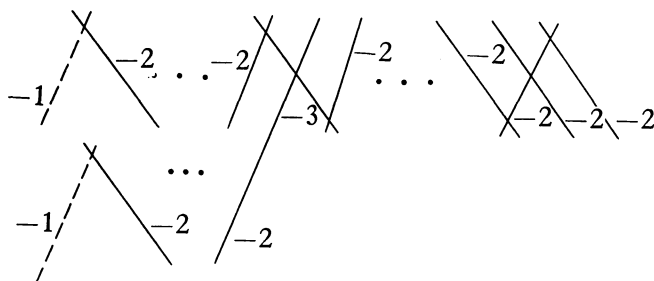

(iii)

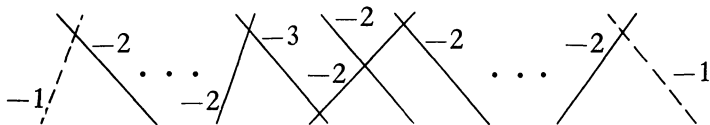

(iv)

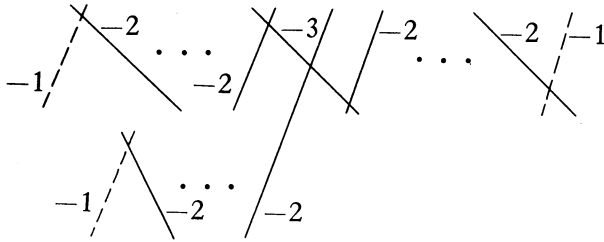

(v)

Picture (2)

(2) *the sum of the coefficients of all  $(-1)$  curves in  $f$  is more than two provided  $f$  contains a  $(-a)$  curve with  $a \geq 3$ .*

(3) *Suppose that there exists a singular fiber  $f_1$  such that  $f_1$  is of type (i) or (ii) in Lemma 1.5 and  $C$  is the unique  $(-1)$  curve in  $f_1$ . Suppose that  $-(C, D^\sharp + K_V)$  attains the smallest positive value in  $\{-(A, D^\sharp + K_V); A \text{ is a nonzero effective divisor}\}$ . Then each singular fiber consists of  $(-2)$  curves and  $(-1)$  curves, say  $E_1$  and  $E_2$  (possibly  $E_1 = E_2$ ), with  $-(E_i, D^\sharp + K_V) = -(C, D^\sharp + K_V)$ .*

Proof. (1) We contract  $(-1)$  curves and consecutively (smoothly) contractible curves in  $f$  one by one. Use the induction argument and Lemma 1.5, (3).

(2) If  $a=3$ , the assertion (2) follows from the assertion (1) above. In general, let  $u: V \rightarrow W$  be the contraction of some  $(-1)$  curves and consecutively (smoothly) contractible curves in  $f$  so that  $u(f)$  satisfies the hypothesis of (1). Then, retaining  $f$  back from  $u(f)$ , the assertion (2) follows.

(3) If  $f_2 (\neq f_1)$  has a  $(-a)$  curve with  $a \geq 3$  then  $-2(C, D^\sharp + K_V) = -(f_1, D^\sharp + K_V) = -(f_2, D^\sharp + K_V) \geq -3(C, D^\sharp + K_V)$  by Lemma 1.5 and by the assertion (2) above. This is absurd. The rest of (3) is easy to prove. Q.E.D.

We end this section with the following:

**Lemma 1.7.** *Write  $D = \sum_{i=1}^n D_i$ . Let  $\{B_1, \dots, B_r\}$  ( $1 \leq r \leq n$ ) be a part of  $\{D_1, \dots, D_n\}$ , say  $B_i = D_i$  ( $1 \leq i \leq r$ ), and assign formally the numbers  $(B_i^2)$  to  $B_i$  so that  $(D_i^2) \leq (B_i^2) \leq -2$ . Write  $D^\sharp = \sum_{i=1}^n a_i D_i$ . Define rational numbers  $b_1, \dots, b_r$  by the condition*

$$\left( \sum_{i=1}^r b_i B_i + K_V, B_j \right) = 0 \quad (j = 1, \dots, r)$$

where  $(B_i, B_j) := (D_i, D_j)$  if  $i \neq j$  and  $(B_i, K_V) := -2 - (B_i^2)$ . Then  $a_i \geq b_i \geq 0$  ( $i=1, \dots, r$ ). Taking  $r=1$ , we obtain  $a_i \geq 1 + \frac{2}{(D_i^2)}$ .

Proof. Note that the matrix  $((B_i, B_j))$  is negative definite. Since  $(\sum_{i=1}^r b_i B_i, B_j) = -(K_V, B_j) = 2 + (B_j^2) \leq 0$ , we see  $b_i \geq 0$ . We have only to show that  $(\sum_{i=1}^r (a_i - b_i) B_i, B_j) \leq 0 (1 \leq j \leq r)$  in order to prove  $a_i \geq b_i$ . By using  $(\sum_{i=1}^n a_i D_i + K_V, D_k) = 0 (1 \leq k \leq n)$ , we see that  $(\sum_{i=1}^r (a_i - b_i) B_i, B_j) = (\sum_{i=1}^r a_i B_i + K_V, B_j) - (\sum_{i=1}^r b_i B_i + K_V, B_j) = (\sum_{i=1}^r a_i D_i + K_V, D_j) + a_j (B_j^2) + (B_j, K_V) - a_j (D_j^2) - (D_j, K_V) \leq a_j (B_j^2) - 2 - (B_j^2) - a_j (D_j^2) + 2 + (D_j^2) = (a_j - 1) ((B_j^2) - (D_j^2)) \leq 0$  for  $j (1 \leq j \leq r)$  because  $0 \leq a_j < 1$  (cf. MT [7]). Q.E.D.

**2. The decomposition of  $D$**

In the present section we fix an irreducible curve  $C$  such that  $-(C, D^\sharp + K_V)$  attains the smallest positive value.

We prove the following three lemmas used in the forthcoming arguments. The original proofs are due to Miyanishi and Tsunoda (cf. [5]).

**Lemma 2.1.** *Suppose  $|C + D + K_V| \neq \emptyset$ . We can find uniquely a decomposition  $D = D' + D''$  such that:*

- (1)  $(C, D_i) = (D', D_i) = (K_V, D_i) = 0$  for any component  $D_i$  of  $D'$ .
- (2)  $C + D'' + K_V \sim 0$ .

Proof. Write  $D = \sum_{i=1}^n D_i$ . If  $C + D + K_V \sim 0$ , set  $D'' = D$  and  $D' = 0$ . So, assume that there exists  $0 < \Gamma = \sum n_i E_i \in |C + D + K_V|$ , where  $E_i$  is irreducible. We may write  $C \equiv -a(D^\sharp + K_V) \pmod{D}$  and  $E_i \equiv -e_i(D^\sharp + K_V) \pmod{D}$ , where  $a > 0$  and  $e_i \geq 0, e_i = 0$  being equivalent to saying that  $E_i$  is a component of  $D$ ; the congruence relation means that  $C + a(D^\sharp + K_V) \equiv \sum_{i=1}^n b_i D_i$  in  $NS(V)_\mathbb{Q}$  for some rational numbers  $b_i$ 's. Note that  $(D^\sharp + K_V)^2 = (K_V^2) > 0$ . So, we obtain  $1 - a = -\sum n_i e_i$ . By the choice of  $C$ , we have  $e_i \geq a$  provided  $e_i > 0$ . Hence we have  $1 \leq \{1 - \sum_{e_i > 0} n_i\} a$ . Therefore  $\sum_{e_i > 0} n_i = 0$ , i.e., every  $E_i$  is a component of  $D$ .

Write  $\Gamma$  anew in the form  $\Gamma = \sum_{i=1}^n a_i D_i$  with  $a_i \geq 0$ . Set  $D' := \sum_{a_i > 0} D_i$  and  $D'' := D - D'$ . Then we have  $C + D'' + K_V \sim \Gamma - D' = \sum_{a_i > 0} (a_i - 1) D_i (=:\Delta) \geq 0$ .

On the other hand, for any component  $D_i$  of  $D'$ , we have  $(\Delta, D_i) = (C, D_i) + (D', D_i) + (K_V, D_i) \geq 0$ . Therefore we have  $(\Delta^2) \geq 0$ , while the intersection matrix of  $D'$  is negative definite, whence  $\Delta = 0$ . This means that  $C + D'' + K_V \sim 0, (C, D_i) = (D', D_i) = (K_V, D_i) = 0$  and  $(D_i^2) = -2$  for every component  $D_i$  of  $D'$ .

We now prove the uniqueness. Suppose  $D = \Delta' + \Delta''$  is another decomposition for which the assertions (1) and (2) hold. Then  $\Delta'' \sim D'' \sim -(C + K_V)$  and hence  $\Delta' - D' = (D - \Delta'') - (D - D'') \sim 0$ . Write  $\Delta' - D' = A - B$  so that  $A \geq 0, B \geq 0$  and  $A$  and  $B$  have no common components. Then  $0 = (A - B, B) = (A, B)$



$-(B^2)$ . Since the intersection matrix of  $D'$  is negative definite, we have  $0 \leq (A, B) = (B^2) \leq 0$ . Hence  $B=0$  and  $A=0$ . So,  $\Delta' = D'$  and  $\Delta'' = D''$ . Q.E.D.

**Lemma 2.2.** *Suppose  $|C+D+K_V| = \phi$ . Then either  $V-D$  is affine-ruled or we may assume that  $C$  is a  $(-1)$  curve.*

Proof. Since  $|C+D+K_V| = \phi$ ,  $C+D$  is an SNC divisor whose components are isomorphic to  $\mathbf{P}^1$  and whose dual graph  $\text{Dual}(C+D)$  is a tree (cf. Miyanishi [6; Lemma 2.1.3]). Fix an ample divisor  $L$  on  $V$ . We assume furthermore that  $(C, L)$  is the smallest value among those  $C$ 's with  $|C+D+K_V| = \phi$  and the smallest positive value  $-(C, D^\sharp + K_V)$ .

*Claim.*  $(C^2) \leq 0$ .

Assume  $(C^2) > 0$ . Then  $\dim |C| \geq \frac{1}{2}(C, C-K) = (C^2) + 1 \geq 2$  by the Riemann-Roch theorem. Let  $P$  be a smooth point of  $D$  and let  $P'$  be an infinitely near point of  $P$  lying on the proper transform of  $D$ . Then  $\dim |C-P-P'| \geq \dim |C| - 2 \geq 0$ . Let  $C' \in |C-P-P'|$ . We assert that  $C' = \Gamma + \Delta$  with  $\Gamma \geq 0$ ,  $\Delta > 0$  and  $\text{Supp}(\Delta) \subseteq \text{Supp}(D)$ . Indeed, if  $C'$  and  $D$  have no common components then  $|C'+D+K_V| \neq \phi$  by the choice of  $C'$ . This contradicts the assumption  $|C+D+K_V| = \phi$ . Notice that  $|\Gamma+D+K_V| = \phi$ ,  $-(\Gamma, D^\sharp + K_V) = -(C, D^\sharp + K_V)$  (hence  $\Gamma > 0$ ) and  $(\Gamma, L) = (C', L) - (\Delta, L) = (C, L) - (\Delta, L) < (C, L)$ . This contradicts the choice of  $C$ .

Consider the case  $(C^2) = 0$ . Then  $\Phi_{|C|}: V \rightarrow \mathbf{P}^1$  is a  $\mathbf{P}^1$ -fibration. By the choice of  $C$  and by the same arguments as above, there are no singular fibers. So,  $V = \sum_n (n \geq 0)$ . If  $D \neq 0$ , then  $D$  is the minimal section on  $V$ . Therefore  $V-D$  is affine-ruled. If  $(C^2) < 0$  then  $C$  is a  $(-1)$  curve because  $(C, K_V) \leq (C, D^\sharp + K_V) < 0$ . Q.E.D.

**Lemma 2.3.** *Suppose that  $|C+D+K_V| = \phi$ , that  $C$  is a  $(-1)$  curve and that  $C$  meets at least three components  $D_0, D_1$  and  $D_2$  of  $D$ . Then either  $G := 2C + D_0 + D_1 + D_2 + K_V \sim 0$  or there exists a  $(-1)$  curve  $\Gamma$  such that  $G \sim \Gamma$  and  $(C, \Gamma) = (D_i, \Gamma) = 0$  for  $i=0, 1, 2$ .*

Proof. The condition  $|C+D+K_V| = \phi$  implies  $(C, D_i) = 1$  and  $(D_i, D_j) = 0$  ( $i=0, 1, 2$  and  $i \neq j$ ). Hence  $(G, C) = (G, D_i) = 0$  and  $(G^2) = (G, K_V)$ . Note that  $h^2(G) = h^0(K_V - G) = h^0(-2C - D_0 - D_1 - D_2) = 0$ . By the Riemann-Roch theorem,  $h^0(G) \geq \frac{1}{2}(G, G - K_V) + 1 = 1$ . Assume  $G \not\sim 0$ . Let  $0 < \Gamma = \sum n_i E_i \in |G|$ . Write  $C \equiv -a(D^\sharp + K_V) \pmod{D}$  and  $E_i \equiv -e_i(D^\sharp + K_V) \pmod{D}$ , where  $a > 0$  and  $e_i \geq 0$ . Substituting these into  $G \sim \sum n_i E_i$  and noting that  $(D^\sharp + K_V)^2 > 0$ , we obtain  $(-2a+1) = -\sum_{e_i > 0} n_i e_i \leq -a \sum_{e_i > 0} n_i$  (cf. Lemma 2.2). Hence  $1 \leq (2 - \sum_{e_i > 0} n_i) a$  and  $\sum_{e_i > 0} n_i \leq 1$ .

*Claim.*  $C \cap \text{Supp}(\Gamma) = D_i \cap \text{Supp}(\Gamma) = \phi (i = 0, 1, 2).$

If  $C \cap \text{Supp}(\Gamma) \neq \phi$  then  $C \leq \Gamma$  for  $(C, \Gamma) = (C, G) = 0$ . Hence  $0 \leq \Gamma - C \in |\Gamma - C| = |G - C| = |C + D_0 + D_1 + D_2 + K_V|$ , which implies  $|C + D + K_V| \neq \phi$ . This is a contradiction. If  $D_i \cap \text{Supp}(\Gamma) \neq \phi$  for some  $i (i = 0, 1, 2)$  then  $\Gamma - D_i \geq 0$  for  $(D_i, \Gamma) = 0$ . Since  $(\Gamma - D_i, C) < 0$ , we have  $0 \leq \Gamma - D_i - C \in |\Gamma - D_i - C|$  which implies  $|C + D + K_V| \neq \phi$ . This is absurd.

Consider first the case  $\sum_{e_i > 0} n_i = 0$ . Then  $\text{Supp}(\Gamma) \subseteq \text{Supp}(D)$ . It is easy to see that  $(\Gamma, E_i) = (2C + D_0 + D_1 + D_2 + K_V, E_i) \geq 0$  for every component  $E_i$  of  $\Gamma$ . So,  $(\Gamma^2) \geq 0$ . On the other hand, the intersection matrix of  $D$  is negative definite. So, we must have  $\Gamma = 0$ . This contradicts the additional assumption  $\Gamma > 0$ . Thus  $\sum_{e_i > 0} n_i = 1$ . Rewrite  $\Gamma = \Gamma_0 + \Delta$  where  $\Gamma_0 (\cong D)$  is an irreducible curve and  $\Delta$  is an effective divisor with  $\text{Supp}(\Delta) \subseteq \text{Supp}(D)$ . Note that  $(\Gamma_0^2) \leq (\Gamma_0, \Gamma_0 + \Delta) = (\Gamma_0, 2C + D_0 + D_1 + D_2 + K_V) = (\Gamma_0, K_V) \leq (\Gamma_0, D^\# + K_V) < 0$  by virtue of the above claim. So,  $\Gamma_0$  is a  $(-1)$  curve and  $(\Gamma_0, \Delta) = 0$ . It is easy to see that  $(2C + D_0 + D_1 + D_2 + K_V, \Delta_i) \geq 0$  for every irreducible component  $\Delta_i$  of  $\Delta$ . So,  $(\Delta^2) = (\Gamma - \Gamma_0, \Delta) = (\Gamma, \Delta) = (2C + D_0 + D_1 + D_2 + K_V, \Delta) \geq 0$ . This implies  $\Delta = 0$  because the intersection matrix of  $D$  is negative definite. Thus  $G \sim \Gamma = \Gamma_0$ .

Q.E.D.

In the following sections, we treat the case  $|C + D + K_V| \neq \phi$  and the case  $|C + D + K_V| = \phi$  separately.

### 3. Structure theorem in the case $|C + D + K_V| \neq \phi$

We define a **quasi-Iitaka surface** as a pair  $(V, D)$  such that:

- (i)  $V$  is a nonsingular projective rational surface and  $D$  is a reduced effective divisor on  $V$ ,
- (ii)  $D$  admits a decomposition into integral divisors  $D = A + N$ , where  $A > 0, N \geq 0, A + K_V \sim 0$  and  $N$  consists only of  $(-2)$  rods and  $(-2)$  forks.

We call the pair  $(V, D)$  an **Iitaka surface** provided that  $A$  is an SNC divisor. For the relevant results we refer to [11].

Let  $C$  be as in §2. We assume further that  $|C + D + K_V| \neq \phi$ . In the present section we shall verify

**Theorem 3.1.** *Let  $C$  be as above. After replacing  $C$  by a member of  $|C|$  if necessary, we have the following results.*

- (I) *There exists a birational morphism  $u: V \rightarrow V_*$  such that if we let  $A_* = u_*(C + D')$ ,  $N_* = u_*D'$  and  $D_* = u_*D$  then  $A_* + K_{V_*} \sim 0$  and  $N_*$  consists of  $(-2)$  rods and  $(-2)$  forks and such that one of the following cases takes place:*

- (1)  $V_* = \mathbf{P}^2$  or  $\sum_n (n \geq 0)$ .  $A_*$  is an NC divisor and  $N_* = 0$ .
  - (2)  $(V_*, A_* + N_*)$  is an Iitaka surface. There is a  $\mathbf{P}^1$ -fibration  $\Phi: V_* \rightarrow \mathbf{P}^1$  such that  $A_*$  consists of a 2-section and a nonsingular fiber and that the components of  $N_*$  are contained in fibers of  $\Phi$  (cf. [11; Lemma 2.5]).
  - (3)  $(V_*, A_* + N_*)$  is a quasi-Iitaka surface such that  $A_*$  is an irreducible curve with  $p_a(A_*) = 1$  and that  $\rho(V_*) = \#N_* + 1$ . If  $A_*$  is nonsingular we may (hence shall) take  $u$  to be the identity morphism.
- (II) Moreover,  $V - D$  is affine-ruled except in the following cases:
- (a) The case (2) above.
  - (b) The case (3) where  $A_*$  is singular.
  - (c) The case (3) where  $A_*$  is nonsingular (hence  $C = A_*$ ) and there exists a birational morphism  $v: V \rightarrow \sum_n (n = 0, 1, 2)$  such that  $v_*(C + D)$  has the configuration Fig. 6, Fig. 7 or Fig. 8 given at the end of the present paper.

The proof consists of several subsections below.

**3.2.** With the notations of Lemma 2.1, we have  $D = D' + D''$ ,  $C + D'' + K_V \sim 0$  and  $D'$  consists of  $(-2)$  rods and  $(-2)$  forks. If  $C + D''$  is an SNC divisor then  $(V, C + D)$  is a log K3 surface. We consider two cases  $D'' = 0$  and  $D'' \neq 0$  separately.

**3.3 Case  $D'' = 0$ .** Then  $C + K_V \sim 0$ . We shall see later that this case leads to the case (3) with nonsingular  $A_*$  in the statement. Note that  $p_a(C) = 1$  and  $(C, K_V) \leq (C, D + K_V) < 0$ . So,  $(C^2) > 0$ . By the Riemann Roch theorem we get  $h^0(C) \geq \frac{1}{2} (C, C - K_V) + \chi(O_V) = (C^2) + 1 \geq 2$ . Since  $C$  is irreducible,  $|C|$  has no fixed components. By the Bertini theorem, a general member of  $|C|$  is irreducible and reduced and has singularities only at the base points if at all. Then we verify

*Claim (1).* General members of  $|C|$  are nonsingular.

Assume the claim is false. Then general members have a common singularity  $P$  which is a base point of  $|C|$ . So,  $P$  is a singular point of  $C$ . Take a general member  $C' (\neq C)$  such that  $C'$  passes through  $(C^2) - 1$  distinct points  $(\neq P)$  on  $C$ . This is possible because  $\dim |C| \geq (C^2)$ . Then  $(C^2) = (C, C') \geq 4 + (C^2) - 1 = (C^2) + 3$ . This a contradiction. Hence the assertion holds true.

So, replacing  $C$  by a general member of  $|C|$  if necessary, we may assume that  $C$  is a nonsingular elliptic curve. Hence  $(V, C + D)$  is a log K3 surface. In particular, it is an Iitaka surface with  $\rho(V) = \#Bk(C + D) + 1$ . Take  $u = id$  in Theorem 3.1 and we can verify second assertion by the following

**Proposition 3.3.** *Let  $(V, A + D)$  be a quasi-Iitaka surface with  $A + K_V \sim 0$ .*

If  $V-D$  is not affine-ruled, then  $A$  is a nonsingular elliptic curve and there exists a birational morphism  $v: V \rightarrow \Sigma_n (n=0, 1, 2)$  such that  $v_*(A+D)$  is given in Fig. 6, Fig. 7 or Fig. 8 at the end of the present paper, where by the abuse of notations we rewrite  $v_*A$  as  $A$ .

Proof. Suppose that  $V-D$  is not affine-ruled. Then using the arguments for the proof of Reduction Theorem in [11], we can show that there exists a birational morphism  $v: V \rightarrow \Sigma_n (n=0, 1, 2)$  such that  $v_*A \in |-K_{\Sigma_n}|$  (possibly reducible),  $v_*(A+D)$  has one of the configurations Fig. 1, ..., Fig. 9 given at the end of the paper, and  $v_*A$  (and hence  $A$ ) is a nonsingular elliptic curve if the configuration of  $v_*(A+D)$  is the one given in Fig. 6, Fig. 7 or Fig. 8. So, there exists a birational morphism  $v_1: V \rightarrow V_1$  such that  $v_{1*}(A+D)$  is given below in the corresponding configuration Fig. 1', Fig. 2', Fig. 3', Fig. 4', Fig. 5' (consisting of Fig. 5.1', Fig. 5.2' and Fig. 5.3'), Fig. 6', Fig. 7', Fig. 8' and Fig. 9'; where  $v_{1*}A$  is possibly reducible and Fig. 6', Fig. 7' and Fig. 8' are given in Theorem 3.7; furthermore  $(V_1, v_{1*}(A+D))$  is a quasi-Iitaka surface (see [11; Remark 2.4, Lemmas 3.5, 4.2 and 5.3] and Lemma 3.5 below). It is enough to

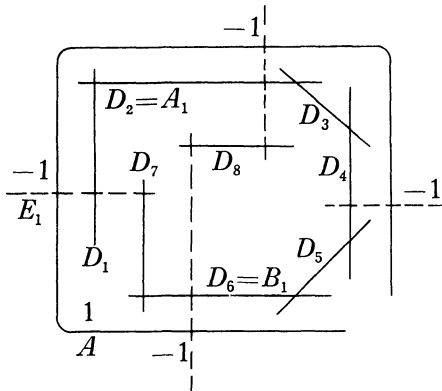

Fig. 1'

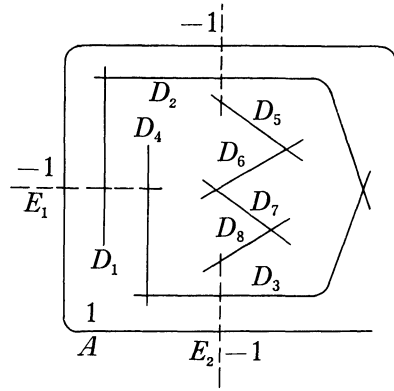

Fig. 2'

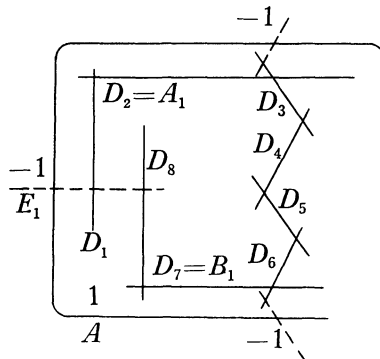

Fig. 3'

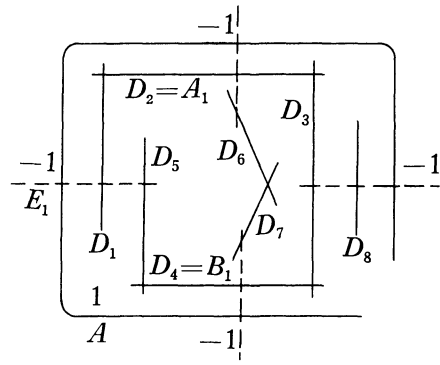

Fig. 4'

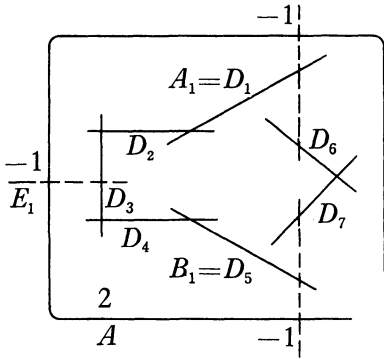

Fig. 5.1'

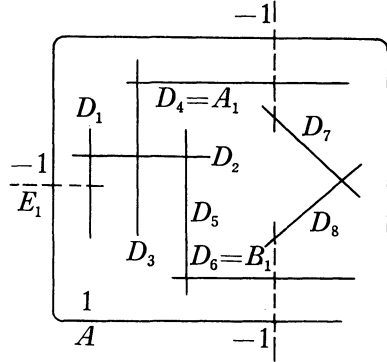

Fig. 5.2'

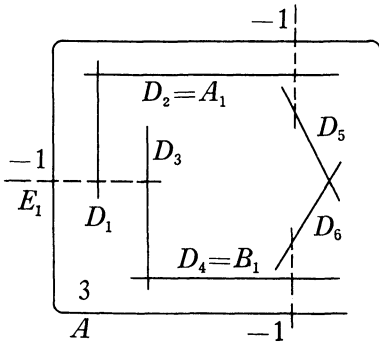

Fig. 5.3'

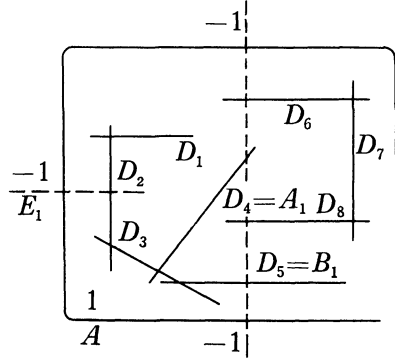

Fig. 9.1'

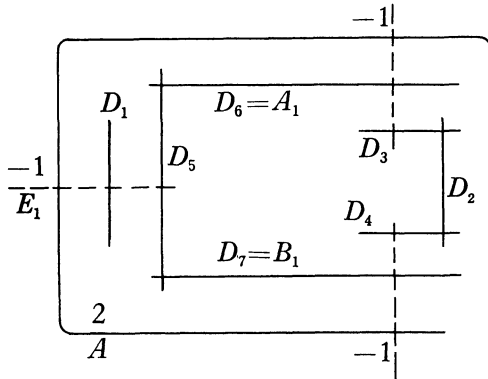

Fig. 9.2'

prove that  $V_1 - v_{1*} D$  is affine-ruled if  $v_*(A + D)$  is given in one of the configurations Fig. 1, ..., Fig. 5 and Fig. 9. Hence we may assume that  $v_1 = id$  and  $A + D$  is given in one of the configurations above, where  $(D_i^2) = -2$  for all  $i$ .

Suppose  $v_*(A+D)$  has the configuration as given in Fig. 2. Then  $A+D$  is as given in Fig. 2'. Note that  $E_1 + \sum_{i=1}^4 D_i + K_V \sim 0$ . Let  $w: V \rightarrow W$  be the contraction of  $E_2 + \sum_{i=5}^8 D_i$  and all  $(-1)$  curves on  $V$  except for  $E_1$ . Then  $w_*D + w_*E_1 + K_W \sim 0$  and there are no  $(-1)$  curves contained in  $W - w_*D$ . By Theorem 3.13 in [6; p. 46],  $W - w_*D$  (and hence  $V - D$ ) is affine-ruled. Suppose that  $v_*(A+D)$  is given in Fig. 1, Fig. 3, Fig. 4, Fig. 5 or Fig. 9. As shown in the above picture, there exist a  $\mathbf{P}^1$ -fibration  $\Phi: V \rightarrow \mathbf{P}^1$  and two disjoint components  $A_1$  and  $B_1$  of  $D$  such that every component of  $D - A_1 - B_1$  is contained in fibers and the conditions of the following lemma are satisfied. So,  $V - D$  is affine-ruled.

**Lemma 3.3.** *Let  $V$  be a nonsingular projective rational surface and let  $D$  be a reduced effective divisor with SNC. Suppose that there exist a  $\mathbf{P}^1$ -fibration  $\Phi: V \rightarrow \mathbf{P}^1$  and two components  $D_1$  and  $D_2$  of  $D$  such that:*

- (i) *every component of  $D - D_1 - D_2$  is contained in fibers and  $D_1$  and  $D_2$  are disjoint cross-sections;*
- (ii) *for every fiber  $f$ , except for at most two, say  $f_1, f_k (k \leq 2)$ ,  $D_i (i=1$  or  $2$ , depending on  $f)$  meets a component of  $f$  not in  $D$ ;*
- (iii) *if  $k=2$  then  $f_2$  is singular and  $D_1$  and  $D_2$  meet  $f_2$  in different connected components of  $(f_2)_{\text{red}} \cap D$  which means the reduced effective divisor consisting of all common components in  $f_2$  and  $D$ , where  $(f_2)_{\text{red}}$  is the reduced effective divisor with  $\text{Supp}(f_2)_{\text{red}} = \text{Supp}(f_2)$ .*

*Then  $V - D$  is affine-ruled.*

*Proof.* We consider only the case  $k=2$  since the remaining cases are easier. Note that the dual graph  $\text{Dual}(f_2)$  of  $f_2$  is a connected tree. By the condition (iii), there exists a component  $E$  in  $(f_2)_{\text{red}} - (f_2)_{\text{red}} \cap D$  and an edge  $e$  in  $\text{Dual}(f_2)$  sprouting from the vertex  $E$  such that  $\text{Dual}(f_2) - e$  consists of two connected trees  $\Gamma_1$  and  $\Gamma_2$  and  $D_i$  meets a vertex in  $\Gamma_i (i=1, 2)$ . Indeed, consider a connected path (i.e., a linear chain)  $\gamma$  in  $\text{Dual}(f_2)$  connecting  $D_1$  and  $D_2$ . Pursuing the components of  $D$  in the path  $\gamma$  from  $D_1$  we first hit a component  $E$  which is not in  $D$ . We take the edge  $e$  which connects  $E$  to a component of  $D$  in the path locating on the side of  $D_1$ . Let  $v: V \rightarrow W$  be the contraction of all  $(-1)$  curves in  $f_1$  except for the one meeting  $D_1$ , all  $(-1)$  curves in  $f_2$  except for  $E$  and all  $(-1)$  curves in every singular fiber  $f (\neq f_1, f_2)$  except for some component not in  $D$  in which  $D_1$  or  $D_2$  meets. Here and below, by the abuse of terminology, the contraction of all  $(-1)$  curves means the contraction of  $(-1)$  curves as well as consecutively (smoothly) contractible components. Then  $v_*D_1$  and  $v_*D_2$  are disjoint and  $v_*D \leq v_*(D_1 + D_2 + f_1 + (f_2)_{\text{red}} - E)$ . Note that either  $v_*f_2 = v_*E$  is nonsingular or  $v_*E$  is a unique  $(-1)$  curve in  $v_*f_2$ . In the latter case,  $v_*(f_2)_{\text{red}} - v_*E$  consists of two connected components  $\Delta_1$  and  $\Delta_2$  such that  $v_*D_i$  meets  $\Delta_i (i=1, 2)$ .

Furthermore, we can deduce that  $v_*f_2$  is a rod and  $v_*D_1$  and  $v_*D_2$  intersect with two different tips because  $(v_*D_i, v_*f_2)=1$  ( $i=1, 2$ ). Let  $H=v_*(D_1+D_2+f_1+(f_2)_{\text{red}})-v_*E$ . Then  $H$  is reduced and  $H \geq v_*D$ . We shall prove that  $H+v_*E+K_W \sim 0$ . Indeed, let  $w: W \rightarrow \sum_n (n \geq 0)$  be the contraction of all  $(-1)$  curves and consecutively (smoothly) contractible curves in  $v_*f_2$ . We see that  $w_*v_*D_1$  and  $w_*v_*D_2$  are disjoint cross-sections of  $\pi := \Phi_{|w_*v_*f_1|}: \sum_n \rightarrow \mathbf{P}^1$ . We have only to prove the following

*Claim.* Let  $A_1$  and  $A_2$  be two disjoint cross-sections of  $\pi: \sum_n \rightarrow \mathbf{P}^1$ . Let  $L$  be a general fiber of  $\pi$ . Then  $A_1$  or  $A_2$  is a minimal section and hence  $A_2 + A_1 + 2L + K_{\sum_n} \sim 0$ .

Suppose  $A_1$  and  $A_2$  are not minimal sections of  $\pi$ . Let  $M$  be a minimal section of  $\pi$ . Then  $A_i \sim M + a_iL$  for some  $a_i > 0$ . We have  $0 = (A_1, A_2) = -n + a_1 + a_2 \geq 2 - n$ , i.e.,  $n \geq 2$ . On the other hand, since  $A_i$  is irreducible, we have  $a_i \geq n$ . Hence  $0 = (A_1, A_2) = -n + a_1 + a_2 \geq -n + n + n = n$ . This is a contradiction.

By Theorem 3.13 in [6; p. 46], it suffices to prove that there are no  $(-1)$  curves in  $W-H$ ; thus  $W-H$  (and hence  $V-D$ ) is affine-ruled. If there exists such a curve  $F$ , then  $F$  is not in any fiber of  $\Phi \circ v^{-1}$  for  $v_*E$  is the unique (possible)  $(-1)$  curve in all fibers. So,  $F$  must meet  $v_*f_1$  and meets  $H$ . This is absurd.

**3.4.** Case where  $D'' \neq 0$  and  $C+D''$  is not an SNC divisor. We will see at the end of arguments that this case leads to the case (3) with a cuspidal rational curve  $A_*$  in the statement. Since  $|C+K_V| = |-D''| = \phi$ ,  $C$  is a nonsingular rational curve. Since  $(C, K_V) \leq (C, D^*+K_V) < 0$ , we have  $(C^2) \geq -1$ . By the hypothesis,  $C+D''$  contains a subgraph (1) or (2):

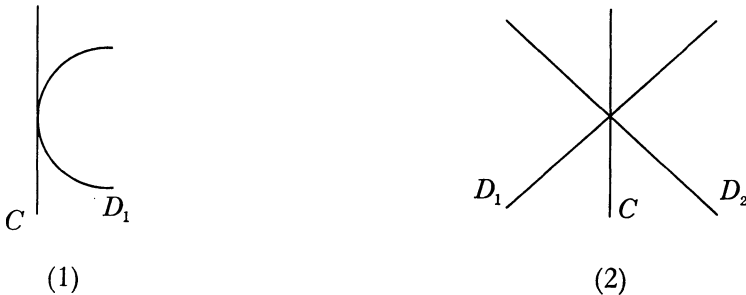

Picture (3)

The condition  $C+D''+K_V \sim 0$  implies that  $C+D''$  is the one given in (1) or (2) of Picture (3), i.e.,  $C+D''=C+D_1$  in the case (1) and  $C+D''=C+D_1+D_2$  in the case (2). Note that  $\dim |C| \geq (C^2)+1$ . So, if  $(C^2) \geq 0$  we can find a new nonsingular member  $C'$  in  $|C|$  such that  $C'+D''$  is SNC; this case will be

considered in the following subsection. Thus, we may assume that  $(C^2) \leq -1$ . This, together with  $(C, K_V) < 0$ , implies that  $C$  is a  $(-1)$  curve.

More precisely, we have the following

*Claim.* If  $C+D''$  is as given in the case (2) of Picture (3) and if we assume  $(D_1^2) \geq (D_2^2)$  then  $((D_1^2), (D_2^2)) = (-2, -2), (-2, -3)$  or  $(-2, -4)$ .

Write  $(D_i^2) = -a_i$  with  $a_i \geq 2$  and  $a_1 \leq a_2 (i=1, 2)$ . By Lemma 1.7,  $D^\sharp \geq \left(1 - \frac{a_2+1}{a_1 a_2 - 1}\right) D_1 + \left(1 - \frac{a_1+1}{a_1 a_2 - 1}\right) D_2$ . Hence  $0 > (C, D^\sharp + K_V) \geq 1 - \frac{a_2+1}{a_1 a_2 - 1} + 1 - \frac{a_1+1}{a_1 a_2 - 1} - 1 = \frac{(a_1-1)(a_2-1)-4}{a_1 a_2 - 1}$ . So,  $(a_1, a_2) = (2, 2), (2, 3)$  or  $(2, 4)$ .

Let  $u: V \rightarrow V_*$  be the contraction of  $C$  and consecutively (smoothly) contractible curves in  $C+D''$ . Then it is easy to see that this  $u$  is the one required. Note that  $(A_*^2) = 1, 2, 3$  and  $\#N_* = \rho(V_*) - 1 = 10 - (K_V^2) - 1 = 9 - (A_*^2) > 0$ .

**3.5.** Case where  $D'' \neq 0$  and  $C+D''$  is an SNC divisor. Then  $(V, C+D)$  is an Iitaka surface with a rational loop  $C+D''$ . We shall show the following

**Lemma 3.5.** (1) *There exists a birational morphism  $u: V \rightarrow V_*$  such that one of the following three cases takes place for  $V_*$ :*

- (A)  $V_* = \mathbf{P}^2$  or  $\Sigma_n (n \geq 0)$ ,
- (B)  $V_* \neq \mathbf{P}^2, \Sigma_n$ . There is a  $\mathbf{P}^1$ -fibration  $\Phi: V_* \rightarrow \mathbf{P}^1$  such that all components of  $N_*$  are contained in fibers and  $\rho(V_*) = \#N_* + 2$ ;
- (C)  $V_* \neq \mathbf{P}^2, \Sigma_n$  and  $\rho(V_*) = \#N_* + 1$ ,

where  $A_* = u_*(C+D'')$  and  $N_* = u_*(D')$ . Moreover,  $u$  is a composite of the contraction of the following two types:

- (i) the contraction of a  $(-1)$  curve which is a component of the rational loop (like  $C+D''$ ) in an Iitaka surface,
- (ii) the contraction of a rod  $E+R$ , where  $E$  is a  $(-1)$  curve and  $R$  (might be zero) is a connected component of the part  $D'$  of an Iitaka surface.

(2)  $A_*$  is an NC divisor with  $A_* + K_{V_*} \sim 0$  and  $\text{Supp}(A_*) \cap \text{Supp}(N_*) = \emptyset$ . If  $t$  is the number of the contractions of type (ii) above involved in  $u$ , then  $t = \#A_* + \#N_* - \rho(V_*)$ . (Each  $E$  in (ii) of (i) meets only  $D''$  of  $C+D''$  by Lemma 1.4.)

*Proof.* (1) We follow up the arguments in [11, §2]. Noting that  $C+D$  is the boundary divisor of the Iitaka surface  $(V, C+D)$  and  $D' = Bk(C+D)$ , we contract all connected components of  $D'$  to obtain a projective normal surface  $\bar{V}$  with at worst rational double points as singularities. Applying the Mori theory, we find an extremal ray  $\bar{l}$  and a numerically effective divisor  $\bar{H}$  on  $\bar{V}$  such that  $\bar{H} \cdot \bar{l} = 0$  and  $\bar{H} \cdot \bar{N}_{\bar{V}}(\bar{V}) = \mathbf{R}_+[\bar{l}]$ . We have three cases to consider:

- (1)  $\bar{H} \equiv 0$ . Then  $\rho(\bar{V}) = 1$  and  $-K_{\bar{V}}$  is ample.
- (2)  $\bar{H} \not\equiv 0$  and  $(\bar{H}^2) = 0$ . Then  $\bar{H} \in \mathbf{R}_+[\bar{l}]$  and  $(\bar{l}^2) = 0$ .



(3)  $(\bar{H}^2) > 0$ .

In the case (1), we have the above case (A) or (C). In the case (2), we have the above case (B). In the third case, let  $l$  be the proper transform of  $\bar{l}$  on  $V$ . By Remark 2.4 in [11],  $l$  is either one of the  $(-1)$  curves considered in the case (i) and (ii) in the statement. Consider the contraction of  $l$  in the case (i) and the contraction  $l+R$  in the case (ii). Let it be  $v: V \rightarrow V'$ . Then  $(V', v_*(C+D))$  is again an Iitaka surface. We apply the same argument all over again. At the end, we reach to one of the cases (1) and (2). The pair  $(V_*, A_*+N_*)$  thus obtained is a quasi-Iitaka surface with  $A_*+K_{V_*} \sim 0$  and  $N_*^{\sharp} = 0$ , i.e.,  $N_*$  consists of  $(-2)$  rods and  $(-2)$  forks. If  $\sharp A_* \geq 2$  then  $A_*$  is an SNC divisor and  $(V_*, A_*+N_*)$  is an Iitaka surface. Finally, apply Lemma 2.5 of [11].

(2) The first assertion is clear by the construction of  $u$ . We prove the second assertion. Note that  $\rho(V) = \sharp(C+D'') + \sharp D'$  and that if  $v: V \rightarrow V'$  is the contraction of type (i) or (ii) then  $\rho(V') = \sharp v_*(C+D'') + \sharp v_* D'$  or  $\rho(V') + 1 = \sharp v_*(C+D'') + \sharp v_* D'$ , respectively. Thence follows our assertion. Q.E.D.

We treat the above three cases (A), (B) and (C) independently to show that the above  $u$  meets the demand. Consider the case (A). This case leads to the case (1) in the statement of Theorem 3.1. Indeed, suppose  $N_* \neq 0$ . Then  $V_* = \Sigma_2$ ,  $N_*$  is the minimal section, and  $A_*$  is a nodal curve or a union of two distinct nonsingular members of  $|N_* + 2f|$  by virtue of Lemma 3.5, (2); where  $f$  is the fiber of  $\pi: \Sigma_2 \rightarrow \mathbf{P}^1$  passing through a singular point  $P$  of  $A_*$ . Then one can decompose  $u$  as  $u = u_2 \circ u_1$ , where  $u_1$  is a composite of the contractions of type (i) or (ii) in Lemma 3.5 and  $u_2$  is the contraction of a  $(-1)$  curve  $E$  such that  $u_2(E) = P$ . Instead of  $E$ , we blow down  $u_2' f + u_2' N_*$ . So, one may assume that  $N_* = u_* D' = 0$ . Let  $u_1: V \rightarrow V_1$  anew be the contraction of all  $E+R$  given in the type (ii) to be contracted in  $u$  and all  $(-1)$  curves  $E$  with  $(E, C) = 1$ . Then  $u_{1*} D' = 0$ ,  $u_{1*} C + u_{1*} D + K_{V_1} \sim 0$  and there are no  $(-1)$  curves in  $V_1 - u_{1*} D$ . So,  $V_1 - u_{1*} D$  (and hence  $V - D$ ) is affine-ruled by Theorem 3.13 in [6; P. 46].

Suppose the case (B) takes place. Then  $t = \sharp A_* - 2 \geq 0$ . Hence  $A_*$  is a rational loop and  $(V_*, A_* + N_*)$  is an Iitaka surface. After contracting  $N_*$ , we obtain a projective normal surface  $\bar{V}_*$  which drops in the case (2) in the proof of the above lemma. Now apply Lemma 2.5 in [11] to conclude that  $V_*$  has a  $\mathbf{P}^1$ -fibration  $\Phi: V_* \rightarrow \mathbf{P}^1$  and  $A_*$  consists of a nonsingular 2-section and a nonsingular fiber of  $\Phi$ . Hence  $t = 0$  and  $\sharp N_* = \rho(V_*) - 2 > 0$  (since  $V_* \neq \mathbf{P}^2, \Sigma_n$ ). So, this is the case (2) of Theorem 3.1.

Consider the last case (C). This case will lead to the case (3) in the statement of Theorem 3.1 where  $A_*$  is a nodal singular curve. By [11, Lemmas 3.1, (iii), 3.5, 4.2 and 5.3], either there exist a  $\mathbf{P}^1$ -fibration  $\Phi: V_* \rightarrow \mathbf{P}^1$  and a component  $B_1$  of  $N_*$  such that every component of  $N_* - B_1$  is contained in a fiber of  $\Phi$  and  $B_1$  is a cross-section, or  $A_*$  is a rational nodal curve and there exists a birational morphism  $v: V_* \rightarrow \Sigma_n$  ( $n = 0, 1, 2$ ) such that  $v_*(A_* + N_*)$  has configura-

ation Fig. 1, ..., Fig. 5 or Fig. 9 given at the end of the paper, where  $A := v_*A_*$  is a rational nodal curve. Suppose the first case occurs. The condition  $\rho(V_*) = \#N_* + 1$  implies that every singular fiber  $f$  of  $\Phi$  is of type (i) or (ii) given in Lemma 1.5. Let  $v: V_* \rightarrow \Sigma_2$  be the contraction of all  $(-1)$  curves and consecutively (smoothly) contractible curves in fibers except for those meeting  $B_1$ . Then  $v_*f \cap v_*A_*$  consists of exactly one smooth point of  $v_*A_*$ , where  $v_*f$  touches  $v_*A_*$  with order of contact 2. So,  $v_*A_* \in |-K_{\Sigma_2}|$  is a nodal curve. Hence  $A_* \in |-K_{V_*}|$  is a nodal curve. In particular, one obtain that  $t=0$  and  $\#N_* = \rho(V_*) - 1 \geq 2$ . This completes the proof of Theorem 3.1.

More precisely, we have the following

**Theorem 3.6.** *Let  $(V, D)$  be a log del Pezzo surface of rank one with contractible boundaries. Assume that  $D$  consists of  $(-2)$  rods and  $(-2)$  forks. Then  $V - D$  is affine-uniruled. Namely, there exists a dominant morphism  $\phi: \mathbf{A}^1_k \times U \rightarrow V - D$ , where  $U$  is an affine curve.*

REMARK. By Durfee [4], the assumption in Theorem 3.6 is equivalent to that  $\bar{V}$  has only Gorenstein quotient singularities.

Proof. By the hypothesis, we have  $D^\sharp = 0$ . Hence  $-(A, K_V) = -(A, D^\sharp + K_V) \geq 0$  for every irreducible curve  $A$  on  $V$ . We may assume that  $D \neq 0$ . If  $\#D = 1$  then  $V = \Sigma_2$  and  $D$  is the minimal section on  $\Sigma_2$ .  $V - D$  is obviously affine-ruled. So, we assume that  $\#D \geq 2$ . Hence  $\rho(V) = \#D + 1 \geq 3$ . Note that  $1 \leq (D^\sharp + K_V)^2 = (K_V^2) \leq 7$ . Since there are no  $(-a)$  curves with  $a \geq 3$  on  $V$  (cf. Lemma 1.3),  $V$  is obtained from  $\mathbf{P}^2$  by blowing up  $9 - (K_V^2)$  points on  $\mathbf{P}^2$  (some points among them might be infinitely near points of the others). So, by Demazure [3; III, Theorem 1, p. 39] there is a nonsingular irreducible curve  $A$  in  $|-K_V|$  because the condition (d) in Theorem 1 there is met. Then  $(V, A + D)$  is an Iitaka surface. Note that  $(A, D) = -(K_V, D) = 0$  because  $D$  consists of  $(-2)$  curves. So, it suffices to prove the following

**Theorem 3.7.** *Let  $(V, A + D)$  be an Iitaka surface with  $A + K_V \sim 0$ . Then  $V - D$  is affine-uniruled.*

The proof of Theorem 3.7. By Proposition 3.3, we may assume that  $v_*(A + D)$  has the configuration Fig. 6, Fig. 7 or Fig. 8 given at the end of the present paper, where  $v$  is the morphism considered in the same Proposition and, in the figures,  $v_*A$  is rewritten as  $A$  by the abuse of notations.

Suppose  $v_*(A + D)$  is given in Fig. 7. Then  $A + D$  becomes the following configuration through a birational morphism  $v_1: V \rightarrow V_1$ . In the following configuration, by the abuse of notations we rewrite  $v_1(D_i)$ , etc. as  $D_i$ , etc. In fact, we may (and shall) assume  $v_1 = id$ .

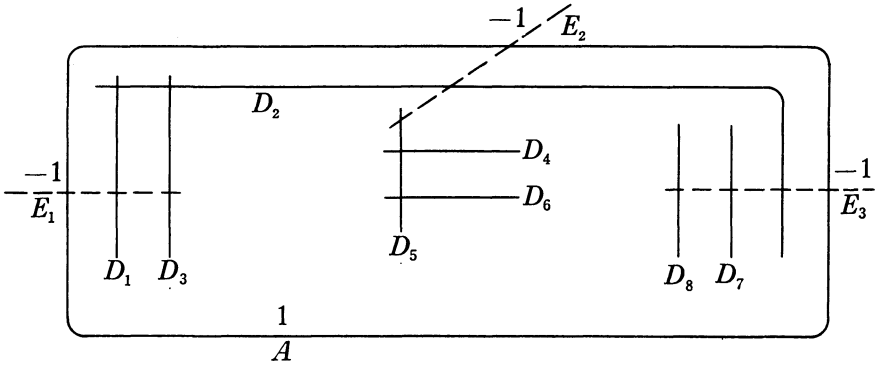
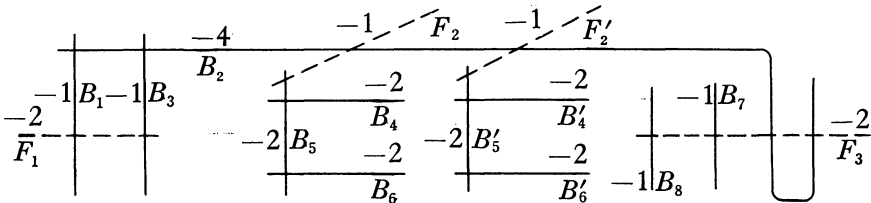

Fig. 7'

where  $(D_i^2) = -2$  ( $i=1, \dots, 8$ ). Let  $f_0 = 2E_1 + D_1 + D_3$  and let  $\Phi = \Phi_{|f_0|}: V \rightarrow \mathbf{P}^1$ . Then  $2E_1 + D_1 + D_3 + 2E_3 + D_7 + D_8 \sim 2f_0$ . Hence  $D_1 + D_3 + D_7 + D_8 \sim 2(f_0 - E_1 - E_3)$ . So, there exists a double covering  $\xi: \tilde{V} \rightarrow V$  with the branch locus  $D_1 + D_3 + D_7 + D_8$ . The configuration  $B := \xi^{-1}D$  is given below, where we denote the components of  $B$  by  $B'_i$  and  $B_j$ .



Picture (4)

Let  $S_0 = 2F_2 + B_1 + B_3 + B_2 + B_5$  and  $\Psi := \Phi_{|S_0|}: \tilde{V} \rightarrow \mathbf{P}^1$ . Then  $\Psi$  is a  $\mathbf{P}^1$ -fibration such that  $B - B_4 - B_6$  is contained in fibers and that  $B_4$  and  $B_6$  are disjoint cross-sections. Thus  $\tilde{V} - B$  is affine-ruled by Lemma 3.3. Hence  $V - D$  is affine-uniruled.

Suppose that  $v_*(A+D)$  is as given in Fig. 8. Then we may assume that  $D+A$  looks like the following, where  $(D_i^2) = -2$  ( $i=1, \dots, 8$ ).

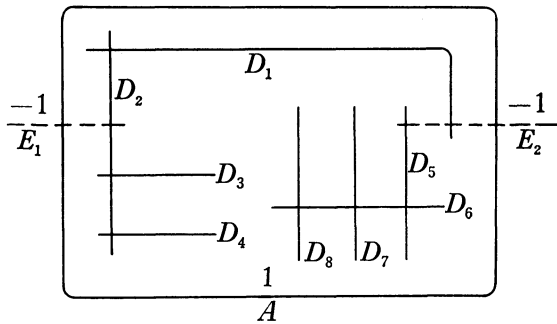
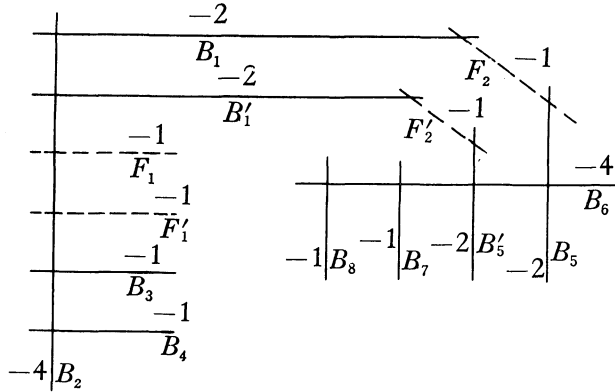

Fig. 8'

As in the previous case, there exists a double covering  $\xi: \tilde{V} \rightarrow V$  which is branched on  $D_3 + D_4 + D_7 + D_8$ . The configuration of  $B := \xi^{-1}D$  is shown as follows:



Picture (5)

Let  $\Phi: \tilde{V} \rightarrow \mathbf{P}^1$  be the  $\mathbf{P}^1$ -fibration associated with  $|F_1 + F_1' + B_3 + B_4 + B_2|$ . Applying Lemma 3.3 to  $\Phi, B_1, B_1'$ , we know that  $\tilde{V} - B$  is affine-ruled. So,  $V - D$  is affine-uniruled.

Suppose that  $v_*(A + D)$  is as given in Fig. 6. Then we may assume that the configuration of  $D$  is given below. The following arguments are derived from [5].

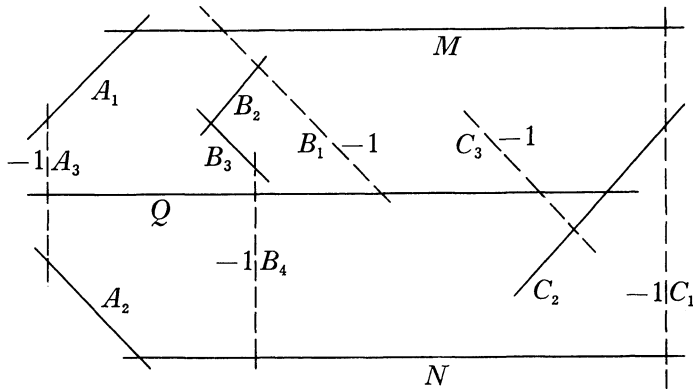

Fig. 6'

where  $D = A_1 + A_2 + B_2 + B_3 + C_2 + M + N + Q$ , every component of  $D$  has self-intersection  $(-2)$  and  $v$  is the contraction of  $A_3, A_2, B_4, B_3, B_2, C_3$  and  $C_2$ . Note that  $|v_*A_1|$  defines a  $\mathbf{P}^1$ -fibration  $\pi: \Sigma_2 \rightarrow \mathbf{P}^1$ . We have:

$$v^*(v_*M + 2v_*A_1) \sim v^*v_*N = N + A_2 + A_3 + B_2 + 2B_3 + 3B_4,$$

$$v^*(2v_*M + 4v_*A_1) \sim v^*v_*Q = Q + A_2 + 2A_3 + B_2 + 2B_3 + 3B_4 + 2C_2 + 3C_3.$$

Hence we get:

$$3v^*(v_*M + 2v_*A_1) \sim N + Q + 2A_2 + 3A_3 + 2B_2 + 4B_3 + 6B_4 + 2C_2 + 3C_3,$$

$$N + Q + 2A_2 + 2B_2 + B_3 + 2C_2 \sim 3\Delta,$$

where  $\Delta$  is an integral divisor. Let  $\sigma_1: V_1 \rightarrow V$  be the composite of the blowings-ups with center  $\{N \cap A_2, B_2 \cap B_3, Q \cap C_2\}$ , the covering morphism of a cyclic 3-covering with the branch locus (the proper transform of)  $N + Q + 2A_2 + 2B_2 + B_3 + 2C_2$  and the normalization of the covering surface. Then  $\sigma_1^{-1}D$  looks like the following:

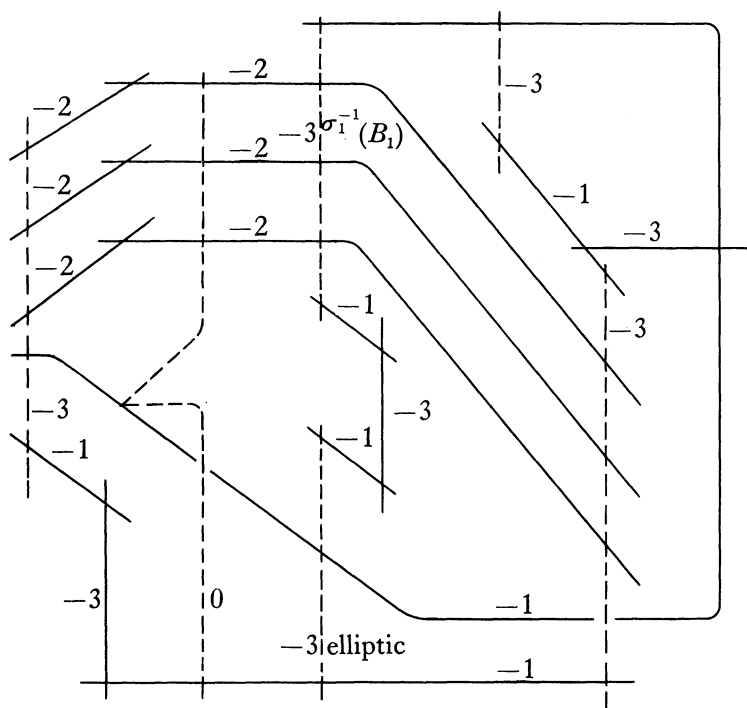

Picture (6)

From the  $\mathbf{P}^1$ -fibration  $\pi \circ v: V \rightarrow \mathbf{P}^1$  we get an elliptic fibration  $\Psi_1: V_1 \rightarrow \mathbf{P}^1$ , all singular fibers of which are given in Picture (6). The cuspidal singular fiber of  $\Psi_1$  comes from the ramification point  $(\neq Q \cap A_3)$  of  $\pi \circ v|_Q$ . Let  $\sigma_2: V_1 \rightarrow V_2$  be the contraction of all  $(-1)$  curves as well as consecutively (smoothly) contractible components in the singular fibers of  $\Psi_1$  except for  $\sigma_1^{-1}(B_1)$  (cf. Picture (7) below). In view of the elliptic fibration  $\Psi_2 := \Psi_1 \circ \sigma_2^{-1}$  defined by  $|A_1 + A_2 + A_3 + E_2 + 2E_3|$ , we know that  $N$  is a cross-section of  $\Psi_2$ . Here  $V_2$  and  $V_1$  are rational surfaces and we have  $K_{V_2} \sim -(A_1 + A_2 + A_3 + E_2 + 2E_3) + E$ . Let  $\sigma_3: V_2 \rightarrow V_3$  be the contraction of  $Q$  and  $N$ . Consider the  $\mathbf{P}^1$ -fibration  $\Phi_3: V_3 \rightarrow \mathbf{P}^1$  defined by

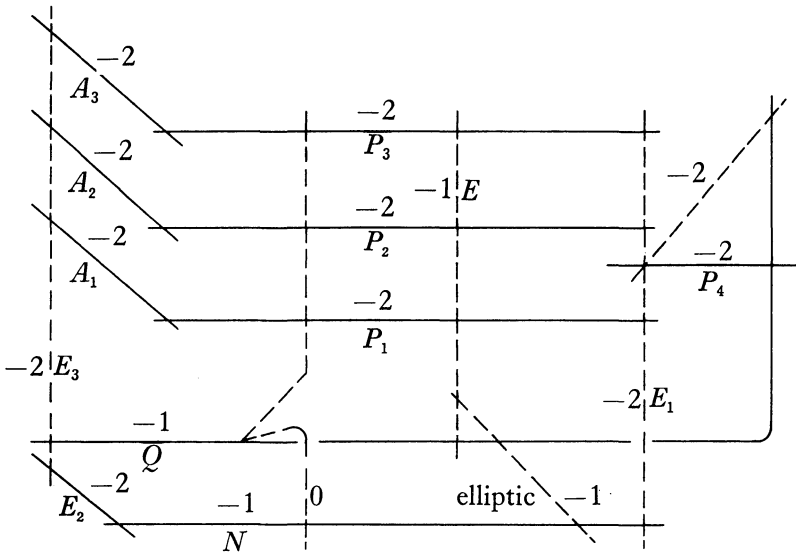

Picture (7)

$|\sigma_3 E_1 + \sigma_3 E_2|$ . We know that  $(K_{V_2}^2) = -1$  and  $(K_{V_3}^2) = 1$ . Note that  $\sigma_3(E_3)$  and  $\sigma_3(P_i)$  ( $i=1, 2, 3, 4$ ) are cross sections of  $\Phi_3$ . Let  $f_i$  be the fiber of  $\Phi_3$  containing  $\sigma_3(A_i)$  ( $i=1, 2, 3$ ). Then  $f_i \neq f_j$  ( $i \neq j$ ) for  $(\sigma_3 E_3, f_i) = 1$ . Evidently, there are at least three components in  $f_i$ , i.e.,  $\#f_i \geq 3$ . Let  $\xi: V_3 \rightarrow \Sigma_2$  be the contraction of all  $(-1)$  curves in the fibers of  $\Phi_3$  except for those meeting  $\sigma_3(P_1)$ . Then  $8 =$

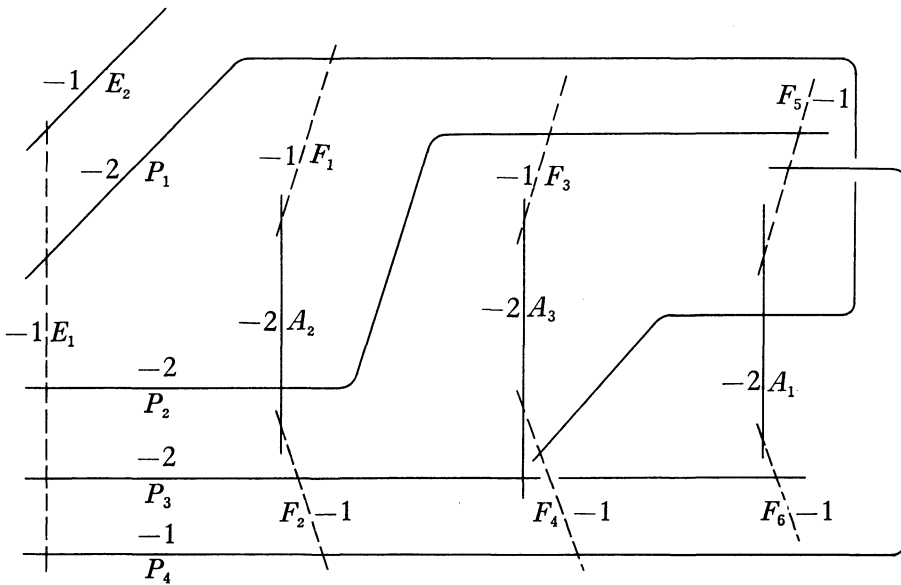

Picture (8)

$(K_{\Sigma_2}^2) = (K_{V_3}^2) + \{\text{the number of blowing-downs in } \xi\} = 1 + \sum_f (\#f - 1) \geq 1 + 1 + \sum_{i=1}^3 (\#f_i - 1) \geq 8$ , where  $f$  moves over all singular fibers in  $\Phi_3$ . So,  $\sigma_3 E_1 + \sigma_3 E_2$  and  $f_i$ 's are all singular fibers in  $\Phi_3$ , where  $\#f_i = 3$  ( $i = 1, 2, 3$ ). Thus,  $f_i$  is of type (i) or (iii) given in Lemma 1.5. By using  $(\xi\sigma_3 P_i, \xi\sigma_3 P_j) = 2$  and  $(\xi\sigma_3 P_1, \xi\sigma_3 P_i) = 0$  ( $i, j = 2, 3, 4$ ), the configuration of  $f_i$ 's is as given in Picture (8) where we rewrite  $\sigma_3(E_i), \sigma_3(P_i)$ , etc. as  $E_i, P_i$ , etc., respectively, by the abuse of notations.

Let  $\eta: V_3 \rightarrow \Sigma_0$  be the contraction of all  $(-1)$  curves in the fibers of  $\Phi_3$  except for  $E_1$  and  $A_i$ 's. Let  $L = \eta(E_1)$  and let  $M$  be a minimal section on  $\pi: = \Phi_{|L}: \Sigma_0 \rightarrow P^1$ . We see:

$$\begin{aligned} \eta^* L &\sim E_1 + E_2 \sim F_1 + F_2 + A_2 \sim F_3 + F_4 + A_3 \sim F_5 + F_6 + A_1, \\ \eta^* M &\sim P_1 + F_1 + F_4 \sim P_2 + F_3 + F_5 \sim P_3 + F_2 + F_6, \\ \eta^*(M + L) &\sim P_4 + F_2 + F_4 + F_5. \end{aligned}$$

This implies that  $2\eta^*(M + L) \sim P_4 + F_2 + F_4 + F_5 + P_2 + F_3 + F_5 + F_3 + F_4 + A_3 = P_4 + F_2 + P_2 + A_3 + 2\Delta$  for some integral divisor  $\Delta$ . Denote by  $\sigma_4: V_4 \rightarrow V_3$  the composite of the blowing-up with center  $P_4 \cap F_2$  and the covering morphism of a double covering with the branch locus (the proper transform of)  $P_4 + F_2 + P_2 + A_3$ . Then the configuration of  $\tilde{D}: = \sigma_4^{-1} \sigma_3 \sigma_2 \sigma_1^{-1} D$  looks like the following:

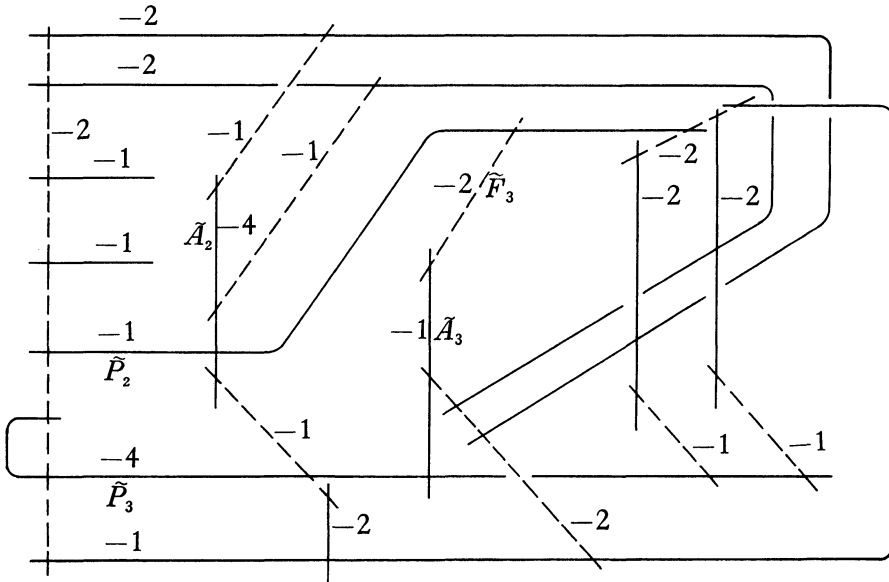

Picture (9)

Consider the  $P^1$ -fibration  $\Phi_4: V_4 \rightarrow P^1$  defined by  $|\tilde{P}_2 + \tilde{F}_3 + \tilde{A}_3|$ . Every component of  $\tilde{D} - \tilde{A}_2 - \tilde{P}_3$  is contained in a fiber of  $\Phi_4$ .  $\tilde{A}_2$  and  $\tilde{P}_3$  are disjoint cross-sections of  $\Phi_4$  which do not meet any component of  $\tilde{D}$  contained in some singular

fiber of  $\Phi_4$  except for  $\tilde{P}_2 + \tilde{F}_3 + \tilde{A}_3$ . So,  $\tilde{V}_3 - \tilde{D}$  is affine-ruled by Lemma 3.3. Hence  $V - D$  is affine-uniruled. Q.E.D.

**4. Preparations for the case  $|C + D + K_V| = \emptyset$**

In the present section, we assume only that  $C$  is a  $(-1)$  curve. Then  $(C, D^\# + K_V) < 0$  because  $C \not\cong D$ . Moreover, if  $-(C, D^\# + K_V)$  is the smallest positive value we will call  $C$  minimal.

**Lemma 4.1.** *Let  $D_1, \dots, D_r$  exhaust all irreducible components of  $D$  such that  $(C, D_i) > 0$ . Suppose  $(D_1^2) \geq (D_2^2) \geq \dots \geq (D_r^2)$ . Then  $\{-(D_1^2), \dots, -(D_r^2)\}$  is one of the following:*

$$\{2^a, n\} (n \geq 2), \{2^a, 3, 3\}, \{2^a, 3, 4\}, \{2^a, 3, 5\}$$

where  $2^a$  signifies that 2 is iterated  $a$ -times.

Proof. Write  $D = \sum_{i=1}^r D_i$  and  $D^\# = \sum_{i=1}^r \alpha_i D_i$ . Denote  $-(D_i^2)$  by  $a_i$ . Then we have  $\alpha_i \geq 1 - \frac{2}{a_i}$  by Lemma 1.7 and  $0 > (C, D^\# + K_V) \geq -1 + \sum_{j=1}^r (1 - \frac{2}{a_j})$ . Suppose  $a_r \geq \dots \geq a_1 \geq 3$ . Then  $r - 1 < \sum_{j=1}^r \frac{2}{a_j} \leq \frac{2}{3} r$ , whence  $r < 3$ . If  $r = 2$  then  $1 < 2(\frac{1}{a_1} + \frac{1}{a_2})$ , i.e.,  $(a_1 - 2)(a_2 - 2) < 4$ . Therefore,  $\{a_1, a_2\} = \{3, 3\}, \{3, 4\}, \{3, 5\}$ . We modify the above argument and easily verify the assertion. Q.E.D.

**Lemma 4.2.** *Suppose  $(C, D) = (C, D_0) = 1$  with an irreducible component  $D_0$  of  $D$ . Then  $(D_0^2) = -2$ .*

Proof. This is a consequence of Lemma 1.4. Q.E.D.

**Lemma 4.3.** *Assume one of the following two conditions:*

- (1)  $C$  meets only one component  $D_0$  of  $D$ ;
- (2)  $C$  meets exactly two components  $D_0$  and  $D_1$  of  $D$  with  $(D_1^2) \leq -3$  and  $(C, D_1) = 1$ .

Let  $\sigma: V \rightarrow W$  be the contraction of  $C$ , let  $E = \sigma(D_0)$  and let  $B = \sigma_*(D - D_0)$ .

Then we have:

- (i) Any connected component of  $B$  is either an admissible rational rod or an admissible rational fork. For the definitions we refer to MT [7].
- (ii) There exists a birational morphism  $g: W \rightarrow \bar{W}$  onto a projective normal surface  $\bar{W}$  carrying at worst quotient singularities such that  $W\text{-Supp}(B) \xrightarrow{\sim} \bar{W} - \text{Sing}(\bar{W})$  and that  $g: W \rightarrow \bar{W}$  is the minimal resolution of singularities on  $\bar{W}$ .
- (iii)  $(W, B)$  is a log del Pezzo surface of rank one with contractible boundaries.

Proof. The assertions (i) and (ii) are clear from the construction. Note that  $\rho(\bar{W}) = \rho(W) - \#B = \rho(V) - 1 - (\#D - 1) = 1$ . We know that



$$\sigma^*(B+K_{\bar{W}}) = \begin{cases} D+K_V-(C+D_0) & \text{in the case (1),} \\ D+K_V-D_0 & \text{in the case (2).} \end{cases}$$

This, together with  $\bar{\kappa}(V-D)=-\infty$ , implies  $\bar{\kappa}(W-B)=-\infty$ . Hence the assertion (iii) holds true by Remark 1.2, (2). Q.E.D.

By virtue of the above lemma, we obtain

**Lemma 4.4.** *Suppose C meets exactly two components  $D_0$  and  $D_1$  of  $D$ . Then either  $(D_0^2)=-2$  or  $(D_1^2)=-2$ .*

*Proof.* Let  $a_i = -(D_i^2)$  ( $i=0, 1$ ). Suppose  $a_1 \geq a_0 \geq 3$ . Then  $\{a_0, a_1\} = \{3, 3\}, \{3, 4\}$  or  $\{3, 5\}$  by Lemma 4.1. If  $(C, D_i) \geq 2$  for  $i=0$  or 1, say  $i=0$ , then  $D^{\sharp} \geq \left(1 - \frac{2}{a_0}\right) D_0 + \left(1 - \frac{2}{a_1}\right) D_1 \geq \frac{1}{3} D_0 + \frac{1}{3} D_1$  and  $(C, D^{\sharp} + K_V) \geq \frac{2}{3} + \frac{1}{3} - 1 = 0$ . This is a contradiction. Hence  $(C, D_i) = 1$  for  $i=0, 1$ . Thus, we can apply Lemma 4.3. With the notations of the same lemma, we have  $(E, B^{\sharp} + K_{\bar{W}}) = (E, g^*K_{\bar{W}}) = (g_*E, K_{\bar{W}}) < 0$  for  $-K_{\bar{W}}$  is ample. On the other hand,  $(E, B^{\sharp}) \geq 0$  and  $(E, K_{\bar{W}}) \geq 0$  because  $E \not\cong B$ ,  $p_a(E) = 0$  and  $(E^2) \leq -2$ . This is a contradiction. Q.E.D.

In particular, if  $|C+D+K_V| = \phi$  then for any irreducible component  $D_1$  of  $D$  with  $(C, D_1) \geq 1$  we have  $(C, D_1) = 1$ .

**5. Structure theorem in the case  $|C+D+K_V| = \phi$ , the part (I)**

We assume, throughout this section, that  $C$  is a minimal  $(-1)$  curve with  $|C+D+K_V| = \phi$ . The goal is to prove Theorem 5.1 below.

**Theorem 5.1.** *Suppose that C meets at least two  $(-2)$  curves  $D_0$  and  $D_1$  of  $D$ . Then either  $V-D$  is affine-ruled, or we are reduced to the situation treated in §3, or  $D$  has the configuration given in Picture (10) below.*

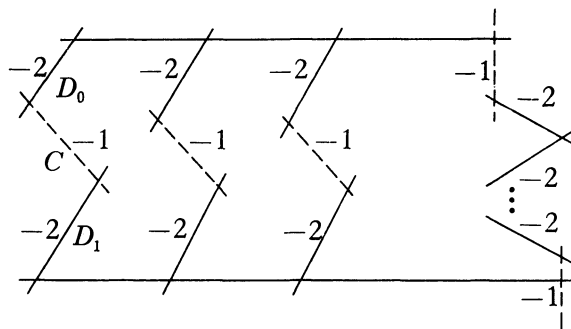

Picture (10)

Our proof consists of the following two lemmas.

**Lemma 5.2.** *Suppose  $C$  meets a component  $D_2$  in  $D-D_0-D_1$ . Then either  $V-D$  is affine-ruled or we are reduced to the situation treated in §3 by replacing  $C$  by a different curve with the same properties as  $C$ .*

*Proof.* Let  $(D_2^2) = -m$ . By Lemma 2.3, either  $2C+D_0+D_1+D_2+K_V \sim 0$ , or  $2C+D_0+D_1+D_2+K_V \sim \Gamma$ , where  $\Gamma$  is a  $(-1)$  curve with  $(\Gamma, C) = (\Gamma, D_i) = 0$  ( $i=0, 1, 2$ ). Let  $S_0 = 2C+D_0+D_1$  and let  $\Phi = \Phi_{|S_0|} : V \rightarrow \mathbf{P}^1$  be the  $\mathbf{P}^1$ -fibration. Then  $(D_2, S_0) = 2(D_2, C) = 2$  for  $|C+D+K_V| = \phi$ . Hence  $D_2$  is a 2-section of  $\Phi$ .

Consider the first case where  $2C+D_0+D_1+D_2+K_V \sim 0$ . Note that  $D-D_2$  is contained in fibers of  $\Phi$ . Indeed, if  $D_i \leq D-D_0-D_1-D_2$ , then  $0 \leq (D_i, S_0) = (D_i, -D_2-K_V) \leq 0$ . So,  $(D_i, S_0) = (D_i, D_2) = (D_i, K_V) = 0$ . Hence  $D_i$  is a  $(-2)$  curve contained in a fiber and  $(D_i, D_2) = 0$ . In particular,  $D_2$  is isolated in  $D$ . By Lemma 1.5, (1), every singular fiber is of type (i) or (ii) given in the same lemma. Applying the Hurwitz formula to  $\Phi_{|D_2|}$ , one sees that  $\Phi$  has at most two singular fibers. Let  $u : V \rightarrow \sum_n$  be the contraction of all  $(-1)$  curves and consecutively (smoothly) contractible curves in the fibers. Then  $n=0$  or 1 because  $u_*D_2$  is an irreducible curve and  $u_*(S_0+D_2) \in |-K_{\sum_n}|$ . Let  $M$  be a minimal section and let  $L$  be a fiber of  $\pi := \Phi \circ u^{-1} : \sum_n \rightarrow \mathbf{P}^1$ . We can write  $u_*D_2 \sim 2M + (n+1)L$ . Hence  $(u_*D_2)^2 = 4$ . Hence  $\Phi$  has exactly two singular fibers  $S_0$  and  $S_1$ . Write  $S_1 = 2(E+D_3+\dots+D_{r-2})+D_{r-1}+D_r$  with a  $(-1)$  curve  $E$  and components  $D_i$ 's of  $D$ . We see that  $4 = (u_*D_2)^2 = -m + 2 + (r-2)$ , i.e.,  $r = m + 4 \geq 6$ . We see also that there is a  $\mathbf{P}^1$ -fibration  $\Phi_1 : V \rightarrow \mathbf{P}^1$  one of whose singular fibers is an effective divisor supported by  $D_2, E, D_3, \dots, D_{m+1}$ . Furthermore, every component of  $D-D_{m+2}$  is contained in a fiber of  $\Phi_1$  and  $D_{m+2}$  is a cross-section. So,  $V-D$  is affine-ruled.

Consider the second case where  $2C+D_0+D_1+D_2+K_V \sim \Gamma$ . Let  $S_1$  be the fiber of  $\Phi$  containing  $\Gamma$ . By Lemma 1.6, (3), every singular fiber of  $\Phi$  consists of  $(-2)$  curves and  $(-1)$  curves each of which is minimal. Note that  $(D_2, \Gamma) = 0$  and  $(D_2, S_1) = 2$ . If  $S_1$  is of type (i) or (iii) in Lemma 1.5, then there exist a  $(-1)$  curve  $E$  (possibly  $\Gamma$ ) and a reduced effective divisor  $\Delta$  with  $\text{Supp}(\Delta) \subseteq \text{Supp}(D)$  such that  $|E+\Delta+K_V| \neq \phi$ . In this case, by replacing  $C$  by  $E$ , we are reduced to the situation treated in §3. Thus, one may assume that  $S_1$  is of type (ii) in Lemma 1.5. Since  $\text{Supp } Bk(D) = \text{Supp}(D)$ ,  $D_2$  meets  $S_1$  as follows:

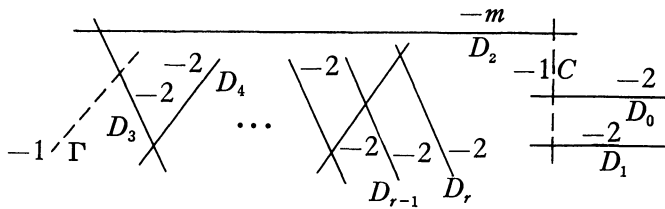

Picture (11)

We assert that  $D - D_2$  is contained in the fibers of  $\Phi$ . Indeed, suppose that  $D_i \leq D - D_2$  is not in any fiber of  $\Phi$ . Then  $(D_i, \Gamma) = (D_i, S_0 + D_2 + K_V) \geq (D_i, S_0) \geq 1$ . On the other hand,  $(D_i, S_0) = (D_i, S_1) \geq (D_i, 2\Gamma) > (D_i, \Gamma)$ . This is absurd. As in the previous case, we can prove that  $r = m + 5 \geq 7$  and that there exists a  $\mathbf{P}^1$ -fibration  $\Phi_1: V \rightarrow \mathbf{P}^1$  one of whose singular fibers is an effective divisor supported by  $D_2, \Gamma, D_3, \dots, D_{m+2}$ . Moreover,  $D_{m+3}$  is a cross-section of  $\Phi_1$  and other components of  $D$  are contained in fibers of  $\Phi_1$ . Hence  $V - D$  is affine-ruled. Q.E.D.

**Lemma 5.3.** *Suppose that  $C$  does not meet any component of  $D - D_0 - D_1$ . Then either  $V - D$  is affine-ruled, or we are reduced to the situation treated in §3, or  $D$  has the configuration as given in picture (10).*

*Proof.* Let  $S_0 = 2C + D_0 + D_1$  and  $\Phi = \Phi_{|S_0|}$  be the same as in Lemma 5.2. Let  $\varepsilon_i$  be the number of components of  $D - D_0 - D_1$  meeting  $D_i (i=0, 1)$ . If  $\varepsilon_0 + \varepsilon_1 \leq 1$ ,  $V - D$  is clearly affine-ruled. So, we may assume  $\varepsilon_0 + \varepsilon_1 \geq 2$ .

Consider first the case  $\varepsilon_i \geq 2$  for  $i=0$  or 1, say  $i=0$ . Let  $D_2$  and  $D_3$  be components of  $D$  such that  $(D_2, D_0) = (D_3, D_0) = 1$ . Since  $|C + D + K_V| = \phi$ , we have  $(D_2, D_3) = 0$ . By virtue of Lemma 1.6, (3), we are reduced to the situation treated in §3, unless the following case

(\*) every singular fiber  $S$  of  $\Phi$  other than  $S_0$  is of type (iii) in Lemma 1.5, and  $D_2$  and  $D_3$  meet  $S$  in two distinct  $(-1)$  curves.

We consider the case (\*). Thus, we may assume  $\varepsilon_0 = 2, \varepsilon_1 \leq 2$ . By Lemma 1.5, (1), there are exactly  $\varepsilon_0 + \varepsilon_1 - 1$  singular fibers of type (iii) in  $\Phi$ .

*Case*  $(\varepsilon_0, \varepsilon_1) = (2, 0)$ . Then the conditions in Lemma 3.3 are satisfied. Hence  $V - D$  is affine-ruled.

*Case*  $(\varepsilon_0, \varepsilon_1) = (2, 1)$ . Then there exist exactly  $2 (= \varepsilon_0 + \varepsilon_1 - 1)$  singular fibers  $S_1$  and  $S_2$  of type (iii) in Lemma 1.5. Write  $S_1 = E_1 + G_1 + \dots + G_k + E_2, S_2 = F_1 + H_1 + \dots + H_l + F_2$ . Let  $D_4$  be the component of  $D$  such that  $(D_4, D_1) = 1$ . Denote  $(D_i^2)$  by  $-a_i (i=2, 3, 4)$ . May assume that  $D_i$  meets  $S_j$  as in Picture (12). Let  $u: V \rightarrow \sum_{a_2}$  be the contraction of all  $(-1)$  curves and consecutively (smoothly) contractible curves in fibers except for those meeting  $D_2$ . Then we have:

$$\begin{aligned} a_2 &= (u_* D_4)^2 = -a_4 + 1 + i + j, \\ a_2 &= (u_* D_3, u_* D_4) = i + j. \end{aligned}$$

This implies that  $a_4 = 1$ , which contradicts  $\text{Supp } Bk(D) = \text{Supp}(D)$ .

*Case*  $(\varepsilon_0, \varepsilon_1) = (2, 2)$ . Let  $D_4$  and  $D_5$  be the components of  $D$  such that  $(D_4, D_1) = (D_5, D_1) = 1$ . We may assume that for  $D_4$  and  $D_5$  the condition (\*) above holds. Let  $u: V \rightarrow \sum_{a_2}$  be the contraction of all  $(-1)$  curves and consecutively (smoothly) contractible curves in fibers except for those meeting  $D_2$ . Since  $(u_* D_4)^2 = (u_* D_5)^2 = a_2 \geq 2$ , we may assume that  $D_2, D_3, D_4$  and  $D_5$  meet singular fibers as in Picture (13).

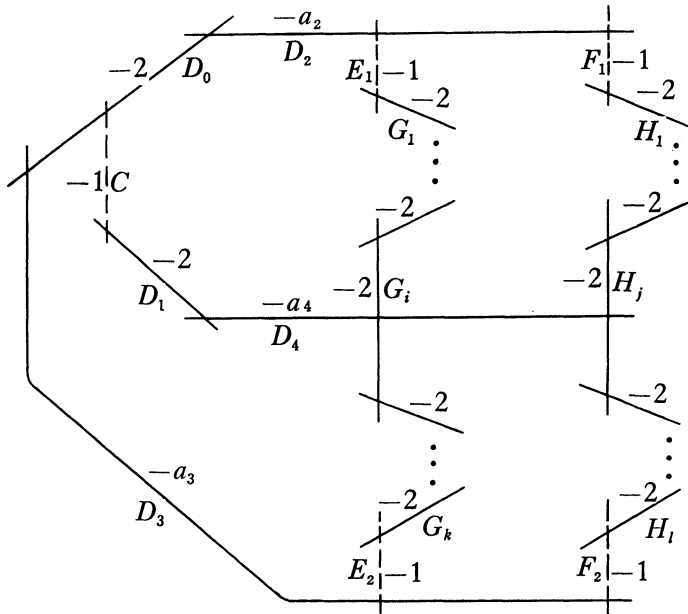

Picture (12)

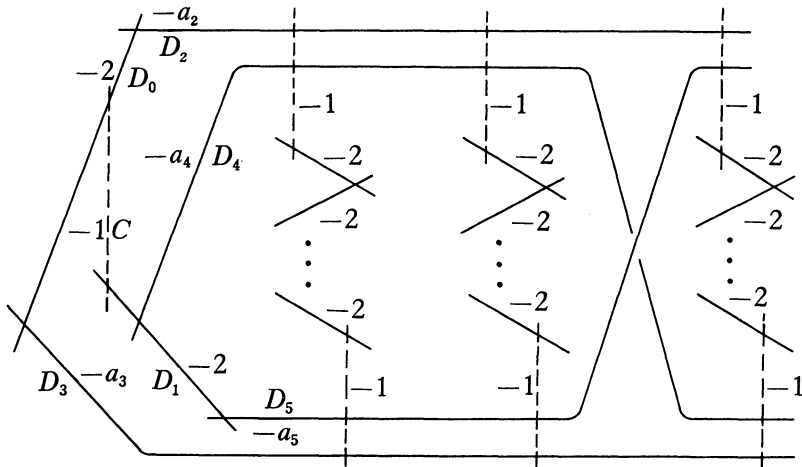

Picture (13)

Note that there are no other singular fibers. But then  $(u_*D_4, u_*D_5)=1 \neq a_2$ . This is a contradiction.

Now, we consider the case  $\varepsilon_i \leq 1$  ( $i=0, 1$ ). Since we have assumed  $\varepsilon_0 + \varepsilon_1 \geq 2$ , we have  $(\varepsilon_0, \varepsilon_1)=(1, 1)$ . Let  $D_2$  and  $D_3$  be the components of  $D$  such that  $(D_2, D_0)=(D_3, D_1)=1$ . Let  $S_0, \dots, S_m$  be all singular fibers of type (i) and let  $S$  be the unique singular fiber of type (iii) given in Lemma 1.5. Since

$|C+D+K_V|=\phi$ , there are no singular fibers of type (ii) given in Lemma 1.5,  $D_2$  and  $D_3$  meet different components of  $D$  in  $S_i$  ( $i=0, 1, \dots, m$ ),  $D_2$  or  $D_3$ , say  $D_2$ , meets a  $(-1)$  curve  $E_1$  in  $S$ ,  $D_2$  and  $D_3$  are disjoint from each other. Write  $S=E_1+R_1+R_2+\dots+R_a+E_2$ .

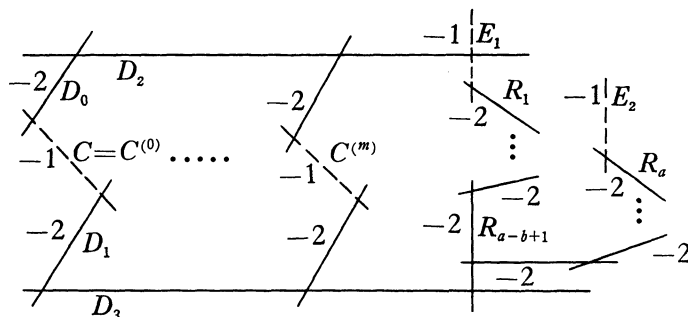

Picture (14)

By virtue of Lemma 1.4, we have  $(D_3, E_1)=0$ . Let  $(D_3, R_{a-b+1})=1$  for some  $(0 \leq b \leq a+1)$ , where  $R_0:=E_1$  and  $R_{a+1}:=E_2$ . By a straightforward calculation, we obtain:

$$\begin{aligned}
 D+K_V \sim ml - \sum_{i=0}^m C^{(i)} - E_1 - E_2 + R_{a-b+2} + 2R_{a-b+3} + \dots \\
 + (b-1)R_a + bE_2 \geq \frac{(m-3)}{2}l + (R_1 + R_2 + \dots + R_a) \\
 + (R_{a-b+2} + \dots + (b-1)R_a + bE_2)
 \end{aligned}$$

where  $l$  is a general fiber of  $\Phi$ . The hypothesis  $\bar{\kappa}(V-D)=-\infty$  implies  $m \leq 2$ . If  $m=2$ , then  $b=0$ , i.e.,  $(D_3, E_2)=1$ , for  $\text{Supp } Bk(D) = \text{Supp } (D)$ , and  $D$  is nothing but the one given in Picture (10). Suppose  $m \leq 1$ . Then  $V-D$  is affine-ruled by applying Lemma 3.3 to  $\Phi, D_2, D_3$ . Q.E.D.

This completes the proof of Theorem 5.1.

**6. Structure theorem in the case  $|C+D+K_V|=\phi$ , the part (II)**

Now we consider the case where  $C$  meets only  $D_0$  in  $D$ . We shall prove the following

**Theorem 6.1.** *Suppose  $C$  meets only  $D_0$  in  $D$ . Then  $V-D$  is affine-uniruled.*

Let  $\Delta$  be the connected component of  $D$  containing  $D_0$ . We treat first the case where  $\Delta$  is a rod.

**Lemma 6.2.** *If  $\Delta$  is a rod then  $V-D$  is affine-ruled.*

*Proof.* By virtue of Lemma 1.4,  $C+\Delta$  is not negative definite. Hence

there exist an integer  $n > 0$  and an effective divisor  $\Delta_0$  such that  $\Delta_0$  is a rod with  $\text{Supp}(\Delta_0) \subseteq \text{Supp}(\Delta)$  and  $|nC + \Delta_0|$  defines a  $\mathbf{P}^1$ -fibration  $\Phi: V \rightarrow \mathbf{P}^1$ . The components  $A$  and  $B$  of  $\Delta$  adjacent to the tips of  $\Delta_0$ , (while  $A$  or  $B$  or both might not exist) are disjoint cross-sections of  $\Phi$ . Every component of  $D - A - B$  is contained in fibers. If  $A$  or  $B$  or both do not exist,  $V - D$  is clearly affine-ruled. Suppose  $A$  and  $B$  exist. Then it is easy to see that the conditions in Lemma 3.3 are met. We can also apply [6; Cor. 2.4.3] to get the same conclusion.

Q.E.D.

We now treat the case where  $\Delta$  is a fork with three twigs  $T_1, T_2, T_3$  and a central component  $R$ , hence  $\Delta = T_1 + T_2 + T_3 + R$ . For the definitions of twigs, etc., we refer to MT [7].

**Lemma 6.3.** *Suppose  $C$  meets one of three twigs, say  $T = T_1$  and that  $C + T$  is not negative definite. Then  $V - D$  is affine ruled.*

Proof. We can define  $\Delta_0, f_1 := nC + \Delta_0, \Phi, A$  and  $B$  as in the previous lemma by considering  $C + T$  instead of  $C + \Delta$ . We can apply Lemma 3.3 to conclude that  $V - D$  is affine-ruled. Indeed, if there exists a singular fiber  $f_2$  (other than  $f_1$ ) observed in Lemma 3.3, it should contain the connected component of  $\Delta - \Delta_0$  not containing the central component  $R$  of  $\Delta$ . Hence there is at most one  $f_2$  other than  $f_1$ . We can also apply [6; Cor. 2.4.3]. Q.E.D.

To finish the proof of Theorem 6.1, we have only to prove the following

**Lemma 6.4.** *Assume that one of the following conditions is satisfied:*

- (i)  $D_0$  is the central component of  $\Delta$ , i.e.,  $D_0 = R$ ;
  - (ii)  $C$  meets a twig  $T$  among  $T_i$ 's ( $i = 1, 3, 2$ ) and  $C + T$  is negative definite.
- Then  $V - D$  is affine-uniruled.

Proof. We define a birational morphism  $u: V \rightarrow W$  as follows and set  $\tilde{D} = u_*D$ . If the condition (i) is met, we let  $u$  be the contraction of  $C$ . Suppose the condition (ii) is met. We let  $u: V \rightarrow W$  be the contraction of all  $(-1)$  curves and consecutively (smoothly) contractible curves in  $C + T$ . Since  $C + T$  is negative definite, either  $u_*(C + T) = 0$  or  $u_*(C + T)$  is an admissible twig in a rational fork  $u_*\Delta$ . In the first case,  $u_*\Delta$  is a rational rod. This way, we define the birational morphism  $u$ . We denote  $u_*R, u_*D_i, u_*\Delta$ , etc. by  $\tilde{R}, \tilde{D}_i, \tilde{\Delta}$ , etc., respectively. By virtue of Lemma 1.4, we see  $(\tilde{R}^2) \geq -1$ . So,  $\text{Supp } Bk(\tilde{D}) = \text{Supp}(\tilde{D} - \tilde{R})$  and  $\tilde{R}$  is an irrelevant component of  $\tilde{\Delta}$ . Making use of the hypothesis that  $|n(D + K_V)| = \phi$  for any  $n > 0$ , we obtain  $|n(\tilde{D} + \tilde{K}_W)| = \phi$  for any  $n > 0$  and hence  $\bar{\kappa}(W - \tilde{D}) = -\infty$ . Let  $g: W \rightarrow \bar{W}$  be the contraction of  $\text{Supp } Bk(\tilde{D})$ . Then  $\rho(\bar{W}) = 1$  because  $\rho(V) = \#D + 1$ .

*Claim.*  $(W, \tilde{D})$  is a log del Pezzo surface of rank one with non-contractible boundaries (for the definition, we refer to MT [8]).

We have only to prove that  $-(g_*\tilde{D}^\sharp + K_{\tilde{W}})$  is ample and  $(W, \tilde{D})$  is almost minimal. These assertions can be verified in the same fashion as for Remark 1.2.

Thus, by Main Theorem and Theorem 7 in [8; p. 272],  $W - \tilde{D}$  (and hence  $V - D$ ) is affine-uniruled. Q.E.D.

We have classified the case where  $C$  meets exactly three components  $D_0, D_1, D_2$  of  $D$  with  $\{(D_0^2), (D_1^2), (D_2^2)\} = \{-2, -3, -3\}, \{-2, -3, -4\}$  or  $\{-2, -3, -5\}$ . This will be treated in our forthcoming paper. However, it remains to consider the case where  $C$  meets exactly two components  $D_0$  and  $D_1$  of  $D$  with  $(D_0^2) = -2$  and  $(D_1^2) \leq -3$ .

### 7. Normal surfaces $\mathbf{P}^2/G$

Let  $G$  be a finite subgroup of  $\text{PGL}(2, k) = \text{Aut}(\mathbf{P}_k^2)$ . Consider the quotient surface  $\tilde{V} := \mathbf{P}^2/G$ . Let  $\pi: \mathbf{P}^2 \rightarrow \tilde{V}$  be the natural morphism which is finite. It is easy to see that  $\tilde{V}$  is a projective, normal surface with only quotient singularities. Let  $g: V \rightarrow \tilde{V}$  be a minimal desingularization such that  $D := g^{-1}(\text{Sing } \tilde{V})$  is an SNC divisor.

**Proposition 7.1.** *The pair  $(V, D)$  is a log del Pezzo surface of rank one with contractible boundaries.*

*Proof.* We can find a sequence of blowing-ups  $f$  and a morphism  $\tau$  such that  $\pi \circ f = g \circ \tau$  and  $\tilde{V}$  is nonsingular;

$$\begin{array}{ccc} \mathbf{P}^2 & \xleftarrow{f} & \tilde{V} \\ \pi \downarrow & & \downarrow \tau \\ \tilde{V} & \xleftarrow{g} & V \end{array}$$

where  $g: V \rightarrow \tilde{V}$  is the minimal resolution of the singularity of  $\tilde{V}$ . Note that  $\deg \tau = \deg \pi$ . Since  $V$  is dominated by a rational surface  $\tilde{V}$ ,  $V$  is a nonsingular projective rational surface. We can define Weil divisors  $\pi_*H$  and  $g_*A$  as usual, where  $H \in \text{Div}(\mathbf{P}^2)$ ,  $A \in \text{Div}(V)$ . Since  $\tilde{V}$  has only quotient singularities, there exists an integer  $N > 0$  such that  $N\bar{A}$  becomes a Cartier divisor for every Weil divisor  $\bar{A}$  on  $\tilde{V}$ . So, we can define the intersection  $(\bar{A}_1, \bar{A}_2) := \frac{1}{N^2}(g^*N\bar{A}_1, g^*N\bar{A}_2)$

for Weil divisors  $\bar{A}_1$  and  $\bar{A}_2$  on  $\tilde{V}$  (cf. MT [7; Lemma 2.4] and Artin [1; Th 2.3 and Cor. 2.6]). Since  $\rho(\mathbf{P}^2) = 1$  we have  $\rho(\tilde{V}) (= \text{rank } NS(\tilde{V})_{\mathbf{Q}}) = 1$ . We verify that the anti-canonical divisor  $-K_{\tilde{V}}$  is ample. We have the adjunction formulas  $K_{\tilde{V}} \sim f^*K_{\mathbf{P}^2} + R_f$ ,  $K_{\tilde{V}} \sim \tau^*K_V + R_\tau$ , where  $R_f, R_\tau$  are the ramification divisors of  $f$  and  $\tau$ , respectively and  $\text{codim } (fR_f) \geq 2$ . Let  $\bar{F} (\neq 0)$  be an effective Cartier divisor on  $\tilde{V}$ . Note that  $g^*K_{\tilde{V}} \equiv D^\sharp + K_V$  and  $(R_\tau, \tau^*g^*\bar{F}) \geq 0$  since

$\rho(\mathcal{V})=1$ . We have  $(K_{\mathcal{V}}, \mathcal{F})=(g^*K_{\mathcal{V}}, g^*\mathcal{F})=(D^{\sharp}+K_{\mathcal{V}}, g^*\mathcal{F})=(K_{\mathcal{V}}, g^*\mathcal{F})=\frac{1}{\deg \pi}$   
 $(\tau^*K_{\mathcal{V}}, \tau^*g^*\mathcal{F})=\frac{1}{\deg \pi}(K_{\tilde{\mathcal{V}}}-R_r, \tau^*g^*\mathcal{F})\leq \frac{1}{\deg \pi}(K_{\tilde{\mathcal{V}}}, \tau^*g^*\mathcal{F})=\frac{1}{\deg \pi}(f^*K_{P^2}+R_f,$   
 $f^*\pi^*\mathcal{F})=\frac{1}{\deg \pi}(f^*K_{P^2}, f^*\pi^*\mathcal{F})=\frac{1}{\deg \pi}(K_{P^2}, \pi^*\mathcal{F})<0$ . So, by virtue of  $\rho(\mathcal{V})=$   
 $1, -K_{\mathcal{V}}$  is ample. Q.E.D.

We now turn to a problem of finding all singularities on a normal surface  $P^2/G$ . Consider the following natural exact sequence:

$$(0) \rightarrow \mathbf{Z}/3\mathbf{Z} \rightarrow SL(3, k) \xrightarrow{\rho} PGL(2, k) \rightarrow (1)$$

Let  $\tilde{G}:=\rho^{-1}(G)$  which is a finite subgroup of  $SL(3, k)$ . We denote by  $k[X_0, X_1, X_2]^{\tilde{G}}$  the invariant subring of the polynomial ring  $k[X_0, X_1, X_2]$  with respect to the linear action of  $\tilde{G}$ . The multiplicative group  $G_m:=k^*$  acts naturally on  $k[X_0, X_1, X_2]$  and  $k[X_0, X_1, X_2]^{\tilde{G}}$ . Hence we have

$$P^2/G=(A^3-(0))/k^*/G \cong (A^3-(0))/\tilde{G}/k^* \cong (A^3/\tilde{G}-(0))/k^*,$$

where  $A^3/\tilde{G}=\text{Spec } k[X_0, X_1, X_2]^{\tilde{G}}$  has a unique fixed point  $(0)$  under the  $k^*$ -action. To give a  $k^*$ -action on the affine scheme  $A^3/\tilde{G}$  is equivalent to giving a  $\mathbf{Z}_+$ -grading on  $k[X_0, X_1, X_2]^{\tilde{G}}=\bigoplus_{d=0}^{\infty} A_d$ , where  $A_d=\{f \in k[X_0, X_1, X_2]^{\tilde{G}} \mid f(aX_0, aX_1, aX_2)=a^d f(X_0, X_1, X_2), \text{ for every } a \in k^*\}$  (cf. Orlik and Wagreich [9; P. 47]).

Hence  $P^2/G \cong \text{Proj } k[X_0, X_1, X_2]^{\tilde{G}}$  where  $k[X_0, X_1, X_2]^{\tilde{G}}$  is given the grading  $\bigoplus_{d=0}^{\infty} A_d$ . Notice that a finite group is linearly reductive. So,  $k[X_0, X_1, X_2]^{\tilde{G}}$  is a finitely generated graded ring over  $k$ .

REMARK 7.2. If there is a finite subgroup  $H$  of  $GL(3, k)$  such that the image of  $H$  by the natural map  $GL(3, k) \rightarrow GL(3, k)/k^* = PGL(2, k)$  is  $G$ , then  $P^2/G \cong (A^3/H-(0))/k^*$ .

Here are several examples.

EXAMPLE 7.3. Let  $G=S_3$  be the symmetric group which is thought of as a subgroup of  $PGL(2, k)$  through the natural action of  $G \subseteq GL(3, k)$  on  $k[X_0, X_1, X_2]$ . Let  $u_1=X_0+X_1+X_2, u_2=X_0X_1+X_1X_2+X_2X_0, u_3=X_0X_1X_2$  be elementary symmetric polynomials. Then  $k[X_0, X_1, X_2]^G=k[u_1, u_2, u_3]$  and  $P^2/G \cong \text{Proj } k[u_1, u_2, u_3]$  where  $u_i$  has weight  $i$  for  $i=1, 2, 3$ . We shall see that there are exactly two rational double points of type  $A_1$  and  $A_2$ , respectively on  $P^2/G$ . Indeed, we have

$$\begin{aligned} \text{Proj } k[u_1, u_2, u_3] &= \text{Spec } k[u_2/(u_1)^2, u_3/(u_1)^3] \cup \\ &\text{Spec } k[(u_1)^2/u_2, (u_1u_3)/(u_2)^2, (u_3)^2/(u_2)^3] \cup \\ &\text{Spec } k[(u_1)^3/u_3, (u_1u_2)/u_3, (u_2)^3/(u_3)^2]. \end{aligned}$$



Hence there are rational double points, one of type  $A_1$  in the second open piece and one of type  $A_2$  in the third open piece.

EXAMPLE 7.4. Let  $\Gamma$  be a finite subgroup of  $GL(2, k)$ . Embed  $\Gamma$  into  $GL(3, k)$  as  $\check{G} = \left\{ \begin{bmatrix} g & 0 \\ 0 & 1 \end{bmatrix}; g \in \Gamma \right\}$ . Let  $G$  be the image of  $\check{G}$  in  $PGL(2, k)$ . Then  $\mathbf{P}^2/G$  contains  $\mathbf{A}^2/\Gamma$  as an open set, and  $Z := \mathbf{P}^2/G - \mathbf{A}^2/\Gamma$  is  $\mathbf{P}^1/\Gamma$ , where  $\Gamma$  acts on  $\mathbf{P}^1$  via its image in  $PGL(1, k)$ . The natural  $G_m$ -action on  $\mathbf{A}^2/\Gamma$ , defined by the  $\mathbf{Z}_+$ -grading on  $k[x, y]^\Gamma$ , gives a  $\mathbf{P}^1$ -fibration  $\phi: V \rightarrow \mathbf{P}^1$  a suitable desingularization  $V$  of  $\mathbf{P}^2/G$  (not necessarily the minimal one), for which the proper transform  $Z'$  of  $Z$  is a cross-section.

To wit, let  $\Gamma$  be a binary icosahedral subgroup of  $SL(2, k)$ . Then one can take  $V$  to be the minimal resolution of the singularity of  $\mathbf{P}^2/G$ , and its  $\mathbf{P}^1$ -fibration  $\phi$  is illustrated as

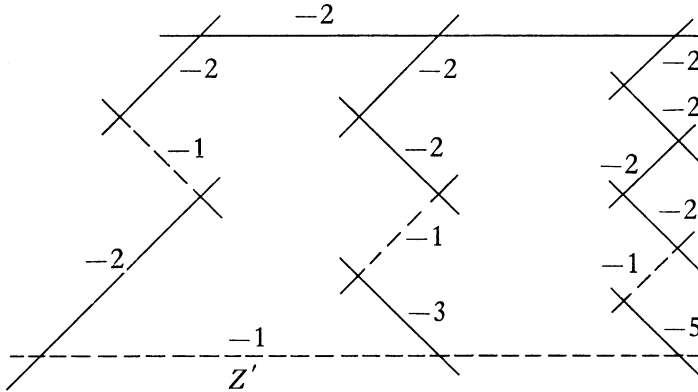

Picture (15)

Let  $\Gamma$  now be a cyclic group of order  $n$ , which is identified with the group of  $n$ -th roots of the unity,  $\Gamma = \{\zeta^i; 0 \leq i < n\}$ . Let  $q$  be an integer such that  $0 < q < n$  and  $(n, q) = 1$ . Consider an embedding  $\Gamma \xrightarrow{\sim} C_{n,q} = \left\{ \begin{bmatrix} \zeta^i & 0 \\ 0 & \zeta^{qi} \end{bmatrix}; 0 \leq i < n \right\} \subseteq GL(2, k)$ . Suppose  $q = n - 1$ . Then  $\mathbf{A}^2/C_{n,n-1}$  has a rational double point of type  $A_{n-1}$ , while  $\mathbf{P}^2/G$  (with the above notations) has two more singularities lying on  $Z$  provided  $n > 2$ . If  $n$  is odd,  $V$  is obtained from the minimal resolution  $S$  of  $\mathbf{P}^2/G$  by blowing up one point  $P$

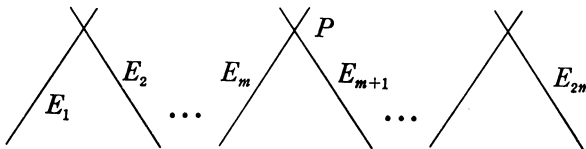

Picture (16)

where  $n=2m+1$  and  $\{E_1, \dots, E_{2m}\}$  is the exceptional locus on  $S$  of the singular point on  $\mathbf{A}^2/\mathbf{C}_{n,n-1}$ . If  $n$  is even, we can take  $S$  as  $V$ .

This example is due to M. Miyanishi.

EXAMPLE 7.5. Let  $\tilde{G}$  be the reflection group of order 336 (cf. Springer [10; p. 98]). Then  $\mathbf{C}[X_0, X_1, X_2]^{\tilde{G}} = \mathbf{C}[f_4, f_6, f_{14}]$  for homogeneous polynomials  $f_4, f_6, f_{14}$  of weights 4, 6, 14, respectively. Let  $G$  be the image of  $\tilde{G}$  by the natural map  $GL(3, \mathbf{C}) \rightarrow PGL(2, \mathbf{C})$ . Then we see

$$\begin{aligned} \mathbf{P}^2/G &\cong \text{Proj } \mathbf{C}[f_4, f_6, f_{14}] = U_1 \cup U_2 \cup U_3, \text{ where} \\ U_1 &= \text{Spec } \mathbf{C}[(f_6)^2/(f_4)^3, (f_6 f_{14})/(f_4)^5, (f_{14})^2/(f_4)^7], \\ U_2 &= \text{Spec } \mathbf{C}[(f_4)^3/(f_6)^2, (f_4 f_{14})/(f_6)^3, (f_{14})^3/(f_6)^7], \\ U_3 &= \text{Spec } \mathbf{C}[(f_4^2 f_6)/f_{14}, (f_4)^2/(f_{14})^2, (f_4 f_6^4)/(f_{14})^2, \\ &\quad (f_6)^7/(f_{14})^3]. \end{aligned}$$

Then there are exactly two rational double singularities, one of type  $A_1$  on  $U_1$  and the other of type  $A_2$  on  $U_2$ . Note that  $\mathbf{C}[X_0, X_1]/\mathbf{C}_{7,5} = \mathbf{C}[X_0^2 X_1, X_0^7, X_0 X_1^4, X_1^7]$ . Hence there is exactly a cyclic quotient singularity of type  $\mathbf{C}^2/\mathbf{C}_{7,5}$  on  $U_3$  whose dual graph is  $\begin{matrix} -2 & -2 & -3 \\ \circ & \text{---} & \circ & \text{---} & \circ \end{matrix}$ .

EXAMPLE 7.6. Let  $\tilde{G}$  be the reflection group of order 648 (cf. [10; p. 101]). Then the invariants subring of the polynomial functions is  $\mathbf{C}[X_0, X_1, X_2]^{\tilde{G}} = \mathbf{C}[f_6, f_9, f_{12}]$  where  $f_6, f_9, f_{12}$  are homogeneous polynomials of weights 6, 9, 12, respectively. Therefore, we have

$$\begin{aligned} \mathbf{P}^2/\tilde{G} &\cong \text{Proj } \mathbf{C}[f_6, f_9, f_{12}] = U_1 \cup U_2 \cup U_3, \text{ where} \\ U_1 &= \text{Spec } \mathbf{C}[f_{12}/(f_6)^2, (f_9)^2/(f_6)^3], \\ U_2 &= \text{Spec } \mathbf{C}[(f_6)^3/(f_9)^2, (f_6 f_{12})/(f_9)^2, (f_{12})^3/(f_9)^4], \\ U_3 &= \text{Spec } \mathbf{C}[(f_6)^2/f_{12}, (f_6 f_9^2)/(f_{12})^2, (f_9)^4/(f_{12})^3]. \end{aligned}$$

Hence there are two rational double singularities of type  $A_2$  and  $A_1$  on  $U_2$  and  $U_3$ , respectively. They exhaust all the singularities of  $\mathbf{P}^2/\tilde{G}$ .

Our recent joint work with Miyanishi shows that the conjecture (2) is false. Hence it becomes important to know criteria for log del Pezzo surfaces of rank one to be written in the form  $\mathbf{P}^2/G$ . For these observations, see a forthcoming joint work with M. Miyanishi [12].

Applying the classification theory for log del Pezzo surfaces developed in the present paper, we have gotten a complete classification of surfaces  $\tilde{V}$  with smaller multiplicity at each singular point of it (cf. [13]).

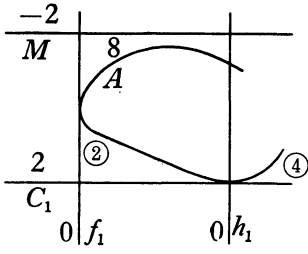

Fig. 1

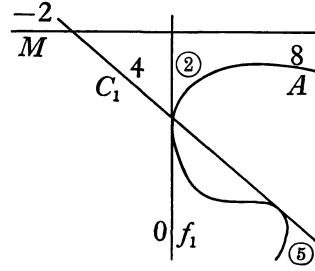

Fig. 2

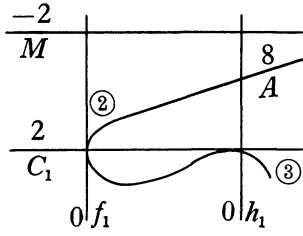

Fig. 3

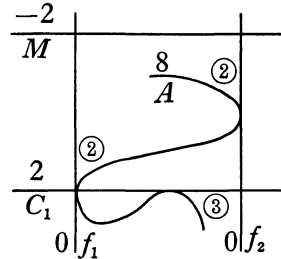

Fig. 4

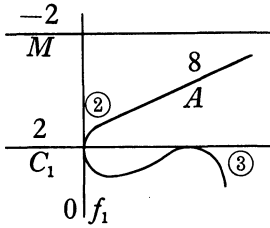

Fig. 5

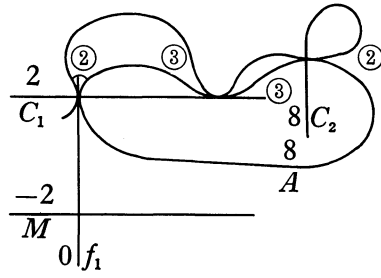

Fig. 6

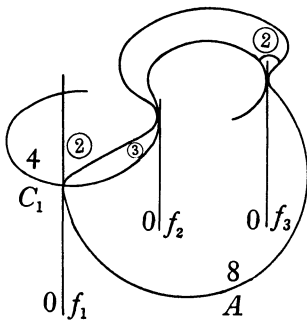

Fig. 7

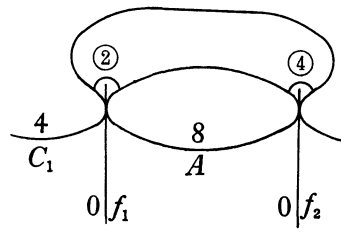

Fig. 8

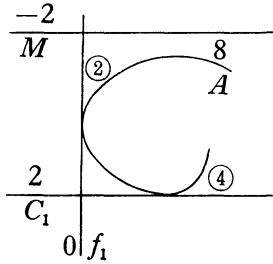

Fig. 9

where a natural number encircled between two curves means the order of contact by which the corresponding curves intersect each other.  $A$  is a reduced effective divisor in  $|-K_{\Sigma_n}|$ . In Fig. 6, Fig. 7 and Fig. 8,  $A$  is a nonsingular elliptic curve. Otherwise,  $A$  is possibly reducible.

#### References

- [1] M. Artin: *Some numerical criteria for contractibility of curves on algebraic surfaces*, Amer. J. Math. **84** (1962), 485–496.
- [2] E. Brieskorn: *Rationale Singularitäten komplexer Flächen*, Invent. Math. **4** (1968), 336–358.
- [3] M. Demazure: *Surfaces de del Pezzo*, Lecture Notes in Math. 777, Berlin-Heidelberg-New York, Springer, 1980.
- [4] A.H. Durfee: *Fifteen characterizations of rational double points and simple critical points*, Enseign. Math. **25** (1979), 131–163.
- [4a] F. Hidaka and K. Watanabe: *Normal Gorenstein surfaces with ample anti-canonical divisor*, Tokyo J. Math. **4** (1981), 319–330.
- [5] M. Miyanishi: *Notes on log del Pezzo surfaces of rank one with contractible boundaries*.
- [6] ———: *Non-complete algebraic surfaces*, Lecture Notes in Math. 857, Berlin-Heidelberg-New York, Springer, 1981.
- [7] M. Miyanishi and S. Tsunoda: *Non-complete algebraic surfaces with logarithmic Kodaira dimension  $-\infty$  and with non-connected boundaries at infinity*, Japan. J. Math. **10** (1984), 195–242; referred to as [MT].
- [8] ——— and ———: *Logarithmic del Pezzo surfaces of rank one with non-contractible boundaries*, Japan. J. Math. **10** (1984), 271–319; referred to as [MT].
- [9] P. Orlik and P. Wagreich: *Algebraic surfaces with  $k^*$ -action*, Acta Math. **138** (1977), 43–81.
- [10] T.A. Springer: *Invariant theory*, Lecture Notes in Math. 585, Berlin-Heidelberg-New York, Springer, 1977.
- [11] D.Q. Zhang: *On Iitaka surfaces*, Osaka J. Math. **24** (1987), 417–460.
- [12] M. Miyanishi and D.Q. Zhang: *Gorenstein log del Pezzo surfaces of rank one*, to appear in J. Algebra. (1988).

- [13] D.Q. Zhang: *On  $dP_3$  Surfaces*, preprint.

Department of Mathematics  
Faculty of Science  
Osaka University  
Toyonaka, Osaka 560, Japan

