

## 1-GENUS 1-BRIDGE SPLITTINGS FOR KNOTS

Dedicated to Professor Yukio Matsumoto on his 60th birthday

CHUICHIRO HAYASHI

(Received March 15, 2002)

### 1. Introduction

A knot  $K$  in the 3-sphere  $S^3$  is called a 1-genus 1-bridge knot if a torus  $H$  splits  $S^3$  into two solid tori each of which  $K$  intersects in a trivial arc. Such splittings for 2-bridge knots are studied in [25]. We show that, if  $K$  is neither a 2-bridge knot nor a satellite knot, and if  $K$  has two non-isotopic 1-genus 1-bridge splitting tori  $H_1, H_2$ , then we can move them to be intersect each other in two essential circles, and either (1)  $K$  is obtained from a component of a 2-bridge link by twisting along the other component, or (2) we can move  $H_1$  and  $H_2$  further to meet in a torus with two holes each circle of which  $c_i$  bounds a disc in  $H_i - K$  and a twice punctured disc in  $H_j - K$  for  $(i, j) = (1, 2)$  and  $(2, 1)$ . We consider also knots in lens spaces.

We recall the precise definition of  $g$ -genus  $n$ -bridge splittings of links. Let  $W$  be a 3-manifold with non-empty boundary  $\partial W$ , and  $T = \{t_1, \dots, t_n\}$  a set of disjoint arcs properly embedded in  $W$ , that is,  $t_i \cap W = \partial t_i$  for every  $1 \leq i \leq n$ . We say  $T$  is *trivial* in  $(W, T)$  if there is a set  $\{D_1, \dots, D_n\}$  of disjoint discs embedded in  $W$  so that  $D_i \cap (\cup T) = \partial D_i \cap t_i = t_i$  and so that  $D_i \cap \partial W$  is the arc  $\text{cl}(\partial D_i - t_i)$ . We call  $D_i$  a *cancelling disc* of  $t_i$ . When  $W$  is a ball and  $T$  is trivial, the pair  $(W, T)$  is called a *trivial  $n$ -string tangle*.

Let  $M$  be a closed orientable 3-manifold, and  $L$  a link in  $M$ . Let  $H$  be a genus  $g$  Heegaard splitting surface of  $M$ , that is,  $H$  divides  $M$  into two handlebodies  $W_1$  and  $W_2$  of genus  $g$ . Suppose that  $H$  is transverse to  $L$ . Then we say  $H$  is a  *$g$ -genus  $n$ -bridge splitting* of  $(M, L)$  if  $L$  intersects  $W_i$  in a trivial set of  $n$  arcs for  $i = 1$  and  $2$ . A link  $L$  is called a  *$g$ -genus  $n$ -bridge link* if it admits a  $g$ -genus  $n$ -bridge splitting. A link in  $S^3$  is simply called an  *$n$ -bridge link* if it has a 0-genus  $n$ -bridge splitting. For studies on positive genus  $n$ -bridge splittings, see [6], [22], [25], [17], [18], [19], [20], [15], and [24].

H. Rubinstein and M. Scharlemann showed in [31] that two strongly irreducible Heegaard splitting surfaces are isotoped to intersect each other in essential loops. They applied this result to isotope two Heegaard splitting surfaces of genus two to intersect each other beautifully ([32]). In [25] T. Kobayashi and O. Saeki generalized the

above result, and made two  $g$ -genus  $n$ -bridge splitting surfaces to intersect each other in “ $K$ -essential” loops as below.

We need to recall some terminologies. In general, let  $X$  be a 3-manifold, and  $T$  a properly embedded 1-manifold in  $X$ , that is,  $T \cap \partial X = \partial T$ . Let  $F$  be a 2-manifold properly embedded in  $X$ . Suppose that  $F$  is transverse to  $T$ . In particular  $\partial F \cap T = \emptyset$ . We say  $F$  is  $T$ -compressible if there is a disc  $D$  embedded in  $X$  such that  $D$  is disjoint from  $T$ , that  $D \cap F = \partial D$  and that  $\partial D$  does not bound a disc disjoint from  $T$  on  $F$ . Such  $D$  is called a  $T$ -compressing disc of  $F$ . We call  $F$  is  $T$ -incompressible if it is not  $T$ -compressible. Note that these definitions are different from those in [25].

Let  $H$  be a 2-manifold properly embedded in  $X$  so that  $H$  is transverse to  $T$ . The 2-manifold  $H$  is said to be *meridionally compressible* in  $(X, T)$  if there is a disc  $D$  embedded in  $X$  such that  $\text{int } D$  intersects  $T$  transversely in a single point, that  $D \cap H = D\partial \cap (H - T) = \partial D$  and that  $\partial D$  in  $H$  does not bound a disc whose interior intersects  $T$  transversely in a single point. Such  $D$  is called a *meridionally compressing disc* of  $H$ . We call  $H$  is *meridionally incompressible* if it is not meridionally compressible. We define a  $T$ -compressible 2-submanifold and a meridionally compressible 2-submanifold of  $\partial X$  similarly.

Assume that either  $P$  is a 2-manifold properly embedded in  $X$  such that  $P$  is transverse to  $T$ , or  $P$  is a 2-submanifold of  $\partial X$  with  $\partial P \cap T = \emptyset$ . A simple loop  $l$  on  $P$  is said to be  $T$ -essential if it is disjoint from  $T$  and if it does not bound a disc which intersects  $T$  transversely in zero or one point.

Let  $M$  be a closed orientable 3-manifold, and  $L$  a link in  $M$ . Let  $H$  be a  $g$ -genus  $n$ -bridge splitting surface of  $(M, L)$ , and  $W_1, W_2$  the handlebodies obtained by cutting  $M$  along  $H$ . We say that  $H$  is *weakly  $K$ -reducible* if  $W_1$  and  $W_2$  contain  $K$ -compressing or meridionally compressing discs  $D_1$  and  $D_2$  of  $H$  respectively such that  $\partial D_1 \cap \partial D_2 = \emptyset$ . We call  $H$  *strongly  $K$ -irreducible* if it is not weakly  $K$ -reducible. Note that these definitions coincide with those in [25] but do not coincide with those in [17].

**Theorem 1.1** (Proposition 6.19 in [25]). *Suppose that  $(M, L)$  is not the pair of the 3-sphere and the trivial knot and that  $M$  has a double cover branched along  $L$ . Let  $H_i$  be a strongly  $K$ -irreducible  $g_i$ -genus  $n_i$ -bridge splitting of  $(M, L)$  for  $i = 1$  and 2. Then we can isotope  $H_1$  and  $H_2$  in  $(M, L)$  so that they intersect each other in a non-empty union of disjoint simple loops which are  $L$ -essential both in  $H_1$  and in  $H_2$ .*

It is well-known that it is easy to isotope the splitting surfaces to be disjoint from each other. Hence the condition “non-empty” in the conclusion is very important. This result has been applied to studies of splittings of 2-bridge knots in [25] and [24]. In particular, every 1-genus 1-bridge splitting of a 2-bridge knot is weakly  $K$ -reducible, and hence is isotopic to a torus obtained by performing a tubing operation on the

2-bridge splitting 2-sphere along a single string of one of the two trivial 2-string tangles (Theorem 8.2 in [25]).

In this paper, we study on 1-genus 1-bridge splittings of 1-genus 1-bridge knots in the 3-sphere or a lens space, where a lens space is a genus one 3-manifold except  $S^2 \times S^1$ .

The class of 1-genus 1-bridge knots (1-bridge torus knots, or (1,1)-knots for short) contains all torus knots and 2-bridge knots ((1.6) in [28]), and is important in light of Heegaard splitting theory ([23], Theorem 4 in [37], [21]) and Dehn surgery theory ([1], [7], [8], [33], [39], [40], [41]). See also [5], [3], [4], [9], [11], [13], [14], [16], [26], [27], [29], [35], [34].

Let  $M$  be the 3-sphere or a lens space. A knot in  $M$  is called the *trivial knot* if it bounds an embedded disc in  $M$ . A knot  $K$  in  $M$  is called a *core knot* if its exterior  $M - \text{int}N(K)$  is a solid torus. As we will see in Section 3,  $(M, K)$  has a weakly  $K$ -reducible 1-genus 1-bridge splitting if and only if  $K$  is the trivial knot, a core knot, a 2-bridge knot in  $S^3$  or a connected sum of a core knot and a 2-bridge knot. A knot in  $M$  is called a *torus knot* if it can be isotoped onto a circle in a Heegaard splitting torus of  $M$ .

Let  $V$  be a solid torus, and  $l, m$  essential loops on  $\partial V$ . The loop  $m$  is of the *meridional slope* if it bounds a disc in  $V$ . The loop  $l$  is of a *longitudinal slope* if it is isotopic to a loop  $l'$  on  $\partial V$  such that  $l'$  intersects  $m$  transversely in a single point.

Let  $(M, K) = (V_1, t_1) \cup_H (V_2, t_2)$  be a 1-genus 1-bridge splitting. We say that the splitting has a *satellite diagram* if there is an essential circle  $l$  on the torus  $H$  such that  $t_1$  and  $t_2$  have cancelling discs  $C_1$  and  $C_2$  disjoint from  $l$ . We call the set of arcs  $\partial C_1 \cap H$  and  $\partial C_2 \cap H$  a satellite diagram, and  $l$  the *slope* of it. We say that the slope of the satellite diagram is *meridional* (resp. *longitudinal*) if it is meridional (resp. *longitudinal*) on  $\partial V_1$  or  $\partial V_2$ . When the slope is meridional,  $K$  is clearly trivial. When the slope is longitudinal on  $\partial V_i$ ,  $K$  can be obtained from a component of a 2-bridge link by a Dehn surgery on the other component, as is essentially shown in [28]. (In fact,  $K$  has a 1-bridge diagram on the annulus  $A = \text{cl}(\partial V_i - N(l))$ , and an adequate Dehn surgery on a core of the other solid torus  $V_j$  deforms  $A$  to a flat annulus in  $S^3$ .) When  $M = S^3$ , the Dehn surgery is the same operation as a twisting. A knot with 1-genus 1-bridge splitting is a non-trivial non-core torus knot or a satellite knot if and only if the splitting has a satellite diagram of non-meridional and non-longitudinal slope. See Theorem 3 in [27], [28] and Theorem III in [14].

**Theorem 1.2.** *Let  $M$  be the  $S^3$  or a lens space, and  $K$  a knot in  $M$ . Let  $H_1$  and  $H_2$  be 1-genus 1-bridge splitting tori of  $(M, K)$  such that they intersect each other in non-empty disjoint union of loops which are  $K$ -essential on both  $H_1$  and  $H_2$ . Then one of the four conditions (1)–(4) below holds.*

- (1)  $H_1$  and  $H_2$  are isotopic in  $(M, K)$ .
- (2) One of the splittings is weakly  $K$ -reducible.

(3) *One of the splittings has a satellite diagram of non-meridional and non-longitudinal slope. Moreover, after an adequate isotopy of  $H_1$  and  $H_2$  in  $(M, K)$ , a loop of  $H_1 \cap H_2$  gives the slope of the satellite diagram.*

(4) *We can isotope  $H_1$  and  $H_2$  in  $(M, K)$  so that they intersect each other in one or two loops which are  $K$ -essential on both  $H_1$  and  $H_2$ .*

In general, let  $X$  be a 3-manifold, and  $T$  a 1-manifold properly embedded in  $X$ . Let  $F$  be a 2-manifold embedded in  $X$  so that  $F$  is transverse to  $T$ . Let  $\gamma$  be a subarc of  $T$  such that  $\gamma \cap F = \partial\gamma$ . We take a small tubular neighbourhood of  $\gamma$ , say  $N(\gamma) \cong \gamma \times D^2$ , so that  $N(\gamma) \cap F = \partial\gamma \times D^2$ . A *tubing operation* on  $F$  along  $\gamma$  is the operation deforming  $F$  into the 2-manifold  $(F - (\partial\gamma \times D^2)) \cup (\gamma \times \partial D^2)$ .

**Theorem 1.3.** *In case of the conclusion (4) of Theorem 1.2, one of the four conditions (a)–(d) below holds after an adequate isotopy of  $H_1$  and  $H_2$  in  $(M, K)$ .*

(a) *One of the conclusions (1)–(3) of Theorem 1.2 holds.*

(b)  *$(M, K)$  is a sum of a trivial 2-string tangle and a pair of a once punctured lens space  $X$  and two strings  $S = s_1 \cup s_2$  properly embedded in  $X$  such that the exterior  $E_i = \text{cl}(X - N(s_i))$  is homeomorphic to a solid torus and the other string  $s_j$  is trivial in  $E_i$  for  $(i, j) = (1, 2)$  and  $(2, 1)$ . Moreover,  $H_i$  is obtained from  $\partial X$  by performing a tubing operation along  $s_i$ , for  $i = 1$  and  $2$ .*

(c) *One of the splittings has a satellite diagram of a longitudinal slope, two splitting tori intersect each other in precisely two loops which are essential on both  $H_1$  and  $H_2$ , and one of them gives the slope of the satellite diagram.*

(d) *There are a solid torus  $V$  embedded in  $M$ , and two disjoint discs  $D_1$  and  $D_2$  on  $\partial V$  as below. The exterior  $\text{cl}(M - V)$  is also a solid torus.  $K$  intersects  $V$  in two arcs. There are two disjoint balls  $B_1$  and  $B_2$  in  $\text{cl}(M - V)$  such that  $V \cap B_i = D_i$ , that  $K$  intersects  $B_i$  in a trivial arc and that  $K$  intersects the solid torus  $V_i = V \cup B_i$  in a trivial arc for  $i = 1$  and  $2$ . Moreover,  $H_i = \partial V_i$  for  $i = 1$  and  $2$ .*

We will obtain the conclusion (c) precisely in Lemmas 5.8 and 7.5. We will obtain the conclusion (d) precisely in the end of Section 7.

K. Morimoto showed in Theorem 3 in [27] that 1-genus 1-bridge splitting torus of a torus knot is unique. H.J. Song and K.H. Ko showed in [35] that the pretzel knot  $P(-2, 3, 7)$  has at least two non-isotopic 1-genus 1-bridge splitting tori.

The author expects that the situation of the conclusion (c) gives many examples of mutually non-isotopic 1-genus 1-bridge splitting tori. In case (c),  $K$  has a 1-bridge diagram on the annulus  $A$  obtained from the splitting torus  $H_i$  by cutting along the circle of slope. Note that the core circle of  $A$  forms a core knot in  $M$ . There are cancelling discs  $C_1, C_2$  which form the satellite diagram composed of the arcs  $(\partial C_i \cap H_i) \subset A$ ,  $i = 1, 2$ . Then  $S_k = \partial N(A \cup C_i)$  is a 1-genus 1-bridge splitting torus having a satellite diagram of longitudinal slope for  $k = 1$  and  $2$ . When are  $S_1$  and  $S_2$  isotopic?

We give an example of case (b) in Section 13 such that the two strings  $s_1$  and  $s_2$  are not parallel in  $X$ .

**Problem 1.4.** Is there a knot which admits two non-isotopic 1-genus 1-bridge splittings located as described in (d)?

The author is wondering whether the conclusion (d) occurs for all the 1-genus 1-bridge knots or only for a special subclass of them. It may be possible that the splitting tori can be isotoped to intersect each other more beautifully in case (d).

The next corollary is on 1-genus 1-bridge knots in  $S^3$ . There is a double covering of  $M$  branched along a knot  $K$  if  $M$  is the 3-sphere (or a  $(p, q)$ -lens space with  $p$  odd). Hence we can apply Theorem 1.1 to 1-genus 1-bridge splittings, and obtain the result below from Theorems 1.2 and 1.3.

**Corollary 1.5.** *Let  $H_i$  be a 1-genus 1-bridge splitting of a knot  $K$  in  $S^3$  for  $i = 1$  and 2. Suppose that  $H_1$  and  $H_2$  are not isotopic in  $(S^3, K)$  and that  $K$  is not a 2-bridge knot nor a satellite knot. Then either*

- (1)  *$K$  is obtained from a component of a 2-bridge link by twisting along the other component, or*
- (2) *the conclusion (d) of Theorem 1.3 holds.*

We can classify all the knot types of 2-bridge knots from the uniqueness of the isotopy classes of 2-bridge splitting spheres. The author expects that all the knot types of 1-genus 1-bridge knots are classified after studies in the course of this paper in the future.

This paper is made up of 13 sections and 4 appendixes. In Section 2, we prepare preliminary lemmas. In particular, we see in Remark 2.6 that every 1-genus 1-bridge splitting has infinitely many 1-bridge diagrams on the torus, while it has a unique “Heegaard diagram”.  $t$ -incompressible and  $t$ - $\partial$ -incompressible surfaces in  $(V, t)$  are studied in Lemma 2.10, where  $V$  is a solid torus, and  $t$  a trivial arc in  $V$ . In Section 3, we consider weakly  $K$ -reducible 1-genus 1-bridge splittings. In Sections 4–12, we give a proof of Theorems 1.2 and 1.3. In Section 4, we consider the “general” case where  $H_1 \cap H_2$  contains three parallel loops on  $H_1 - K$  or  $H_2 - K$ . In Section 5, we consider the case  $H_1 \cap H_2$  is a single loop. We consider the case  $|H_1 \cap H_2| = 2$  in Sections 6–9, the case  $|H_1 \cap H_2| = 3$  in Section 10 and the case  $|H_1 \cap H_2| = 4$  in Section 11. In Section 12, we show that the conclusion “one of the splittings has a semi-satellite diagram of non-meridional and non-longitudinal slope” of Lemma 6.3 implies that either  $H_1$  or  $H_2$  has a satellite diagram, or  $K$  is a torus knot. In Section 13, we give an example of the conclusion (b) of Theorem 1.3 such that  $s_1$  and  $s_2$  are not parallel in  $X$ .

ACKNOWLEDGEMENT. The author would like to thank Shin'ichi Suzuki, Kazuaki Kobayashi, Tsuyoshi Kobayashi, Makoto Sakuma, Kanji Morimoto, Katura Miyazaki, Kimihiko Motegi, Kouki Taniyama, Hiroshi Goda, Koya Shimokawa, Makoto Ozawa, Kazuhiro Ichihara and Hiroshi Matsuda for helpful comments.

## 2. Preliminaries

The next lemma implies that a trivial arc in a solid torus does not have a “local knot”.

**Lemma 2.1.** *Let  $M$  be an irreducible 3-manifold and  $t$  a trivial arc in  $M$ . Any 2-sphere  $S$  embedded in the interior of  $M$  and intersecting  $t$  transversely in two points bounds a trivial 1-string tangle  $(B, t')$ , where  $t' = t \cap B$ .*

Proof. Let  $C$  be a cancelling disc of the trivial arc  $t$  in  $M$ . Since  $M$  is irreducible,  $S$  bounds a ball, say  $B$ , in  $M$ . A standard innermost loop argument shows that we can isotope  $C$  so that  $C$  intersects  $S$  in a single arc connecting the two points  $t \cap S$ . This arc cuts off from  $C$  a cancelling disc of the arc  $t \cap B$  in the ball  $B$ .  $\square$

In the rest of this section,  $V$  denotes a solid torus, and  $t$  a trivial arc in  $V$ . We study “essential” surfaces in  $(V, t)$ .

**Lemma 2.2.** *Let  $D$  be a  $t$ -compressing disc of  $\partial V$ . Then either  $D$  is a meridian disc disjoint from  $t$ , or a peripheral disc which cuts off a ball  $B$  containing  $t$  from  $V$ . In the latter case, we can take a cancelling disc  $C$  of  $t$  with  $C \cap D = \emptyset$ .*

*Let  $Q$  be a meridionally compressing disc of  $\partial V$  in  $(V, t)$ . Then  $Q$  is a meridian disc of  $V$ .*

Proof. When  $\partial D$  is essential on  $\partial V$  (ignoring  $\partial t$ ),  $D$  is a meridian disc disjoint from  $t$ . When  $\partial D$  is inessential on  $\partial V$ ,  $D$  is a peripheral disc cutting off a ball, say  $B$ , from  $V$ . If  $B$  were disjoint from the arc  $t$ , then  $D$  would not be a  $t$ -compressing disc. Hence  $B$  contains  $t$  entirely. By Lemma 2.1,  $t$  is trivial in  $B$ . We can take a cancelling disc  $C$  of  $t$  in the ball  $B$  so that the arc  $\partial C \cap \partial B$  is disjoint from  $D$ .

Suppose that  $\partial Q$  bounds a disc  $Q'$  on  $\partial V$ . Since  $Q$  is a meridionally compressing disc,  $Q'$  contains zero or two points of  $\partial t$ . Hence the 2-sphere  $Q \cup Q'$  intersects  $t$  in one or three points, which contradicts that  $V$  is irreducible.  $\square$

**Lemma 2.3.** *Let  $C$  be a cancelling disc of  $t$  in  $V$ , and  $D$  a meridian disc of  $V$  with  $D \cap t = \emptyset$ . Then we can isotope  $D$  in  $(V, t)$  to be disjoint from  $C$ .*

Proof. We isotope  $D$  in  $(V, t)$  so that  $\partial D$  intersects the arc  $\partial C - t$  transversely in minimum number of points and that  $D$  intersects  $C$  transversely. A standard innermost

loop argument allows us to isotope  $D$  in  $(V, t)$  to cancel all the intersection loops of  $D \cap C$ . Suppose for a contradiction that  $D \cap C$  contains one or more arcs. Let  $\gamma$  be an arc of  $D \cap C$  such that  $\gamma$  is outermost on  $C$  away from  $t$ , that is,  $\gamma$  cobounds a disc  $Q_C$  on  $C$  with a subarc of  $\partial C - t$  such that  $Q_C \cap D = \gamma$ . Let  $A$  be an annulus obtained by cutting  $\partial V$  along  $\partial D$ , and  $l_1$  and  $l_2$  the boundary loops of  $A$ . Then the arc  $\gamma' = \partial Q_C \cap A$  has its endpoints in the same component of  $\partial A$ , say  $l_1$ , and  $\gamma'$  and a subarc of  $l_1$  cobound a disc  $Q_A$  on  $A$ . If  $Q_A$  contained no endpoint of  $t$ , then we could isotope  $D$  along  $Q_A$  to decrease  $|\partial D \cap (\partial C - t)|$ . Hence  $Q_A$  contains the two endpoints  $\partial t$ .  $\partial C \cap A$  contains an arc with its both endpoints in  $l_2$  since  $|l_1 \cap (\partial C - t)| = |l_2 \cap (\partial C - t)|$ . Near an outermost such arc, we can isotope  $D$  along the outermost disc, to decrease  $|\partial D \cap (\partial C - t)|$ . This is again a contradiction.  $\square$

**Lemma 2.4.** *Let  $D_i$  be a meridian disc of  $V$  with  $D_i \cap t = \emptyset$  for  $i = 1$  and  $2$ . Then  $D_1$  and  $D_2$  are isotopic in  $(V, t)$ .*

*Proof.* Let  $C$  be a cancelling disc of  $t$  in  $V$ . Lemma 2.3 allows us to isotope  $D_i$  in  $(V, t)$  so that  $D_i$  is disjoint from  $C$  for  $i = 1$  and  $2$ . After an adequate small isotopy of  $D_1$  in  $(V, t)$ ,  $D_1$  and  $D_2$  intersect each other transversely. Since  $D_1$  and  $D_2$  are meridian discs of  $V$ ,  $\partial D_1$  and  $\partial D_2$  are isotopic in  $\partial V$  (ignoring  $\partial t$ ). If  $\partial D_1 \cap \partial D_2 \neq \emptyset$ , then  $\partial D_1 \cup \partial D_2$  has two bigons on  $H$ , where a bigon is an open disc component of  $H - (\partial D_1 \cup \partial D_2)$  incident to a single arc of  $\partial D_1 - \partial D_2$  and a single arc of  $\partial D_2 - \partial D_1$ . One of the bigons does not contain the arc  $\partial C \cap H$ , and hence is disjoint from  $\partial t$ . We can isotope  $D_1$  along the bigon, to decrease  $|\partial D_1 \cap \partial D_2|$ . Repeating such operations as above, we can isotope  $D_1$  in  $(V, t)$  so that  $\partial D_1 \cap \partial D_2 = \emptyset$ . A standard innermost loop argument shows that we can isotope  $D_1$  to be disjoint from  $D_2$ .  $D_1$  and  $D_2$  together divide  $V$  into two balls, one of which is disjoint from  $t$ . Hence  $D_1$  and  $D_2$  are isotopic in  $(V, t)$ .  $\square$

The next lemma implies that there are infinitely many isotopy classes of cancelling discs of a trivial arc in a solid torus.

**Lemma 2.5.** *Let  $D$  be a meridian disc of  $V$  with  $D \cap t = \emptyset$ . Let  $\alpha$  be an arc on  $\partial V$  with  $\partial \alpha = \partial t$  and  $\alpha \cap \partial D = \emptyset$ . Then there is a cancelling disc  $C$  of  $t$  in  $V$  with  $\partial C \cap \partial V = \alpha$  and  $C \cap D = \emptyset$ .*

*Proof.* Let  $B$  be the ball obtained by cutting  $V$  along  $D$ . By Lemma 2.3  $B$  contains a cancelling disc  $C$  of  $t$ . We can isotope  $C$  in  $B$  near the arc  $\partial C \cap \partial B$  so that  $\partial C \cap \partial B = \alpha$ .  $\square$

**REMARK 2.6.** The above lemma implies that every homeomorphism class of 1-genus 1-bridge splitting has infinitely many isotopy classes of 1-bridge diagrams on

the torus up to homeomorphism, while it has a unique *Heegaard diagram* up to homeomorphism as below. Let  $H$  be an abstract torus, and  $p, q$  two distinct points on  $H$ . Let  $l_1$  and  $l_2$  be two essential loops on  $H$  with  $(l_1 \cup l_2) \cap (p \cup q) = \emptyset$ . From such a system, we can form a 1-genus 1-bridge knot by attaching a solid torus  $V_1$  containing a trivial arc  $t_1$  on the front side of  $H$  so that  $l_1$  bounds a disc disjoint from  $t_1$  in  $V_1$ , and attaching  $(V_2, t_2)$  similarly on the reverse side. By Lemma 2.4, such a diagram is unique under the condition “ $|l_1 \cap l_2|$  is minimal up to isotopy on  $H - (p \cup q)$ ”. Theorem B in [13] and Lemma 2.2 together imply that such a Heegaard diagram represents the trivial knot if and only if  $p$  and  $q$  are in the same component of  $H - (l_1 \cup l_2)$ .

A standard innermost loop and outermost arc argument as in the proofs of the above lemmas shows the next lemma. We omit the proof.

**Lemma 2.7.** *Let  $D$  be a meridian disc of  $V$  with  $D \cap t = \emptyset$ . Let  $Q$  be a meridionally compressing disc of  $\partial V$  in  $(V, t)$ . Then  $Q$  can be isotoped in  $(V, t)$  to be disjoint from the disc  $D$ . Moreover, after such an isotopy we can take a cancelling disc  $C$  of  $t$  so that  $C$  is disjoint from  $D$  and intersects  $Q$  in a single arc connecting the point  $t \cap Q$  and a point in the arc  $\partial C - t$ . Hence we obtain a trivial 2-string tangle by cutting  $(V, t)$  along  $Q$ .*

The next lemma implies that there are infinitely many isotopy classes of meridionally compressing discs of  $\partial V$  in  $(V, t)$ .

**Lemma 2.8.** *Let  $D$  be a meridian disc of  $V$  with  $D \cap t = \emptyset$ . Let  $A$  be the annulus obtained by cutting  $\partial V$  along  $\partial D$ . Let  $l$  be an essential loop on  $\text{int } A$  such that  $l$  separates the two points  $\partial t$  on  $A$ . Then  $l$  bounds a meridionally compressing disc of  $\partial V$  in  $(V, t)$ .*

*Proof.* The loop  $l$  divides  $A$  into two annuli, say  $A_1$  and  $A_2$ . We push the interior of the disc  $A_i \cup D$  slightly into  $\text{int } V$ , to obtain a meridionally compressing disc as desired.  $\square$

In general, let  $X$  be a compact 3-manifold, and  $T$  a 1-manifold properly embedded in  $X$ . Let  $F$  be a 2-manifold such that either  $F$  is properly embedded in  $X$  transversely to  $T$ , or  $F$  is a subsurface of  $\partial X$  with  $\partial F \cap T = \emptyset$ . We say that  $F$  is  *$T$ - $\partial$ -compressible* if there is a disc  $D$  embedded in  $X$  such that (1)  $D \cap T = \emptyset$ , (2)  $D \cap (F \cup \partial X) = \partial D$ , (3)  $\partial D \cap F = \alpha$  is an essential arc in  $F - T$ , (that is,  $\alpha$  does not cobound a disc with a subarc of  $\partial F$  on  $F - T$ ) and (4)  $\partial D \cap (\partial X - \text{int } F) = \beta$  is an essential arc in the surface obtained by cutting  $(\partial X - \text{int } F) - T$  along  $\partial F$ . We call such a disc  $D$  a  *$T$ - $\partial$ -compressing disc* of  $F$ . If  $F$  is not  $T$ - $\partial$ -compressible, then it is  *$T$ - $\partial$ -incompressible*.



REMARK 2.9. In the usual definition, the above condition (4) is omitted. But, this definition of  $T$ - $\partial$ -compressibility is equivalent to the usual one for  $T$ -incompressible surfaces.

**Lemma 2.10.** *Let  $F$  be a 2-manifold properly embedded in  $(V, t)$  such that  $F$  is transverse to  $t$ . Suppose that  $F$  is  $t$ -incompressible and  $t$ - $\partial$ -incompressible. Then  $F$  is a union of several surfaces of types (1)–(6) below.*

- (1) A 2-sphere disjoint from  $t$ .
- (2) A 2-sphere intersecting  $t$  transversely in two points.
- (3) A meridian disc of  $V$  disjoint from  $t$ .
- (4) A meridian disc of  $V$  intersecting  $t$  transversely in a single point.
- (5) A peripheral disc disjoint from  $t$ .
- (6) A peripheral disc intersecting  $t$  transversely in a single point.

Proof.

STEP 1. Let  $C$  be a cancelling disc of  $t$  in  $V$ . Suppose first that  $F$  is disjoint from  $C$ . Let  $V'$  be the solid torus obtained by cutting  $V$  along  $C$ , and  $C'$  be the disc composed of the two copies of  $C$  in  $\partial V'$ . Then  $F$  is contained in  $V'$  and is disjoint from  $C'$ . Since  $F$  is incompressible and  $\partial$ -incompressible also in  $V'$ ,  $F$  is of type (1) or (3) or (5).

STEP 2. We can assume that  $F$  intersects  $C$ . A standard innermost loop argument allows us to isotope  $F$  so that  $F \cap C$  consists of arcs only since  $F$  is  $t$ -incompressible.

STEP 3. Suppose that  $F \cap C$  contains an arc component which has both endpoints in the arc  $\partial C \cap \partial V$ . Let  $\alpha$  be an outermost one away from  $t$  among such arcs, and  $C_1$  the outermost disc of  $\alpha$ . Note that  $C_1 \cap t = \emptyset$ . We perform a  $t$ - $\partial$ -compressing operation on  $F$  along  $C_1$ , to obtain another 2-manifold  $F_1$ . Since  $F$  is  $t$ -incompressible and  $t$ - $\partial$ -incompressible, Remark 2.9 implies that  $\alpha$  cuts off a disc, say  $Q$ , from  $F$  such that  $Q \cap t = \emptyset$ .  $F$  is obtained from  $F_1$  by taking a band sum of the disc  $Q \cup C_1$  disjoint from  $t$  and another component. Note that  $F_1$  is  $t$ -incompressible and  $t$ - $\partial$ -incompressible in  $(V, t)$ . To show that  $F$  is a union of surfaces of types (1)–(6), it is enough to show that  $F_1$  is so. Hence we can assume that  $F \cap C$  does not contain such an arc.

STEP 4. If  $F \cap C$  contains an arc component which has both endpoints in  $t$ . Then let  $\beta$  be an outermost one among such arcs, and  $C_2$  the outermost disc. Note that  $\partial C_2 - \beta \subset t$ . Let  $N'$  be a regular neighbourhood of  $C_2$  in the 3-manifold obtained by cutting  $V$  along  $F$ . Then  $N'$  intersects  $F$  in a disc  $R$  which forms a regular neighbourhood of the arc  $\beta$  in  $F$ . Let  $R_1$  be the disc  $\text{cl}(\partial N' - R)$ . Note that  $R_1 \cap F = \partial R_1$ . Since  $F$  is  $t$ -incompressible, the loop  $\partial R_1$  bounds a disc  $R_2$  disjoint from  $t$  in  $F$ . Thus  $R \cup R_2$  forms a 2-sphere intersecting  $t$  in two points. Let  $F_2$  be a 2-manifold or an emptyset obtained by discarding this 2-sphere from  $F$ .  $F$  is a union of surfaces of

types (1)–(6) if  $F_2$  is a union of such surfaces or an emptyset. Hence we can assume that  $F \cap C$  does not contain such an arc.

STEP 5. Thus  $F \cap C$  contains an arc component which has an endpoint in  $t$  and the other endpoint in the arc  $\partial C \cap \partial V$ . Let  $\gamma$  be an outermost one among such arcs. That is,  $\gamma$  cuts off a disc  $C_3$  from  $C$  such that  $C_3 \cap F = \gamma$  and that  $C_3$  is cobounded by  $\gamma$ , a subarc of  $t$  and a subarc of  $\partial C \cap \partial V$ . Let  $N''$  be a regular neighbourhood of  $C_3$  in the 3-manifold obtained by cutting  $V$  along  $F$ . Then  $N''$  intersects  $F$  in a disc  $R'$  which forms a regular neighbourhood of  $\gamma$  in  $F$ . Let  $R'_1$  be the disc  $\text{cl}((\partial N'' \cap \text{int } V) - R')$ . Since  $F$  is  $t$ -incompressible and  $t$ - $\partial$ -incompressible, Remark 2.9 implies that the arc  $F \cap \partial R'_1$  cuts off a disc  $R'_2$  disjoint from  $t$  from  $F$ . Thus  $R' \cup R'_2$  forms a disc intersecting  $t$  in a single point. Let  $F_3$  be a 2-manifold or an emptyset obtained by discarding this disc from  $F$ . It is easy to see that  $F$  is a union of surfaces of types (1)–(6) if  $F_3$  is a union of such surfaces or an emptyset. Hence we complete the proof by an induction on the number of the arcs  $F \cap C$ .  $\square$

### 3. Weakly $K$ -reducible splittings

We will show that a 1-genus 1-bridge splitting is weakly  $K$ -reducible if and only if the knot  $K$  is the trivial knot, core knots, 2-bridge knots or composite knots of a core knot and a 2-bridge knot.

Throughout this section, let  $M$  denote the 3-sphere or a lens space, and  $K$  a knot in  $M$  with a 1-genus 1-bridge splitting  $(M, K) = (V_1, t_1) \cup_H (V_2, t_2)$ .

In this paper, we call  $H$  is  $K$ -reducible if there are  $K$ -compressing discs  $D_1$  and  $D_2$  of  $H$  in  $V_1$  and  $V_2$  respectively such that  $\partial D_1 \cap \partial D_2 = \emptyset$ . A  $K$ -reducible 1-genus 1-bridge splitting is weakly  $K$ -reducible. If there are a cancelling disc  $C_1$  of  $t_1$  and a meridian disc  $D_2$  of  $V_2$  disjoint from  $t$  such that  $\partial C_1 \cap D_2 = \emptyset$ , then  $H$  is  $K$ -reducible.

**Lemma 3.1.** *If the splitting  $H$  is  $K$ -reducible, then  $K$  is the trivial knot.*

Proof. Let  $D_1, D_2$  be discs as in the above definition of  $K$ -reducibility. By Lemma 2.2,  $D_i$  is either a meridian disc disjoint from the arc  $t_i$ , or a peripheral disc cutting off from  $V_i$  a ball  $B_i$  with  $t_i \subset B_i$ . Since  $\partial D_1 \cap \partial D_2 = \emptyset$ , at least one of  $D_1$  and  $D_2$  is a peripheral disc. (Otherwise,  $M \cong S^2 \times S^1$ .)

First we suppose that both are peripheral discs. For  $i = 1$  and 2, set  $Q_i = B_i \cap H$ , which is a disc containing  $\partial t$ . By Lemma 2.1, in  $B_i$  we can take a cancelling disc  $C_i$  of  $t_i$  with  $C_i \cap \partial B_i \subset Q_i$ . We can isotope the disc  $C_1$  near the arc  $\partial C_1 \cap (Q_1 \cup Q_2)$  so that  $\partial C_1 \cap H = \partial C_2 \cap H$ . Thus  $K$  is the trivial knot.

Suppose that one of  $D_1$  and  $D_2$ , say  $D_1$ , is a meridian disc. Then  $D_2$  is peripheral, and cuts off a ball  $B_2$  from  $V_2$ . We perform a  $K$ -compressing operation on a copy of the once punctured torus  $H' = \text{cl}(H - B_2)$  along  $D_1$ , to obtain a peripheral disc disjoint from  $t_1$  in  $V_1$ . Then  $K$  is the trivial knot as shown in the previous paragraph.  $\square$

**Lemma 3.2.** *If the splitting  $H$  is weakly  $K$ -reducible, then  $K$  is the trivial knot, a 2-bridge knot in  $S^3$ , a core knot in a lens space or a connected sum of a core knot in a lens space and a 2-bridge knot in  $S^3$ .*

*Proof.* Let  $D_1$  and  $D_2$  be discs as in the definition of weakly  $K$ -reducibility. We can assume that one of them, say  $D_1$ , is a meridionally compressing disc by Lemma 3.1. Then  $D_1$  is a meridian disc of  $V_1$  by Lemma 2.2. Since  $M \not\cong S^2 \times S^1$ ,  $D_2$  is a peripheral  $K$ -compressing disc, and cuts off a ball  $B$  containing  $t_2$  from  $V_2$ . The pair  $(B, t_2)$  is a trivial 1-string tangle by Lemma 2.2. Let  $N$  be a small regular neighbourhood of  $D_1$  in  $V_1$  such that  $t_1$  intersects  $N$  in a single short trivial arc  $t$ . By Lemma 2.7,  $(\text{cl}(V_1 - N), \text{cl}(t_1 - t))$  is a trivial 2-string tangle. Set  $X_1 = N \cup \text{cl}(V_2 - B)$ ,  $X_2 = \text{cl}(V_1 - N) \cup B$  and  $s_i = K \cap X_i$ . Then  $X_1$  is a ball if  $M$  is the 3-sphere, and is a once punctured lens space if  $M$  is a lens space. The exterior of  $s_1$  in  $X_1$  is homeomorphic to the solid torus  $\text{cl}(V_2 - B)$ . Since  $(X_2, s_2)$  is the sum of a trivial 1-string tangle and a trivial 2-string tangle along the disc  $B \cap H$ , we obtain the trivial knot or a 2-bridge knot in the 3-sphere if we attach a trivial 1-string tangle to  $(X_2, s_2)$ .  $\square$

Conversely, we consider weakly  $K$ -reducibility for splittings of such knots.

**Lemma 3.3** (Theorem B in [13]). *If  $K$  is a trivial knot, then  $H$  is  $K$ -reducible.*

Katura Miyazaki told us a very easy proof of the above lemma using the handle addition theorem. We omit it. Similar argument gives an easier proof of the weakly  $K$ -reducibility for core knots as below.

**Lemma 3.4** (Essentially Theorem C in [13], 6.2 Lemma in [21]). *Suppose that  $H$  is not  $K$ -reducible. Then  $K$  is a core knot if and only if there are a cancelling disc  $C_i$  of  $t_i$  in  $V_i$  and a meridian disc  $R_j$  of  $V_j$  with  $R_j \cap t_j = \emptyset$  such that the arc  $\partial C_i \cap H$  intersects  $\partial R_j$  transversely in a single point for  $(i, j) = (1, 2)$  or  $(2, 1)$ .*

**REMARK 3.5.** We can easily see weakly  $K$ -reducibility by isotoping  $R_j$  near  $\partial R_i$  along a subarc of  $\partial C_i \cap H$ .

*Proof.* “If” part follows from Lemma 2.5. We consider the “only if” part. Suppose that  $K$  is a non-trivial core knot. Let  $D_i$  be a meridian disc of  $V_i$  with  $D_i \cap t_i = \emptyset$  for  $i = 1$  and  $2$ . We take regular neighbourhoods  $N(D_2)$  in  $V_2$  and  $N(t_1)$  in  $V_1$  with  $N(D_2) \cap N(t_1) = \emptyset$ . Set  $E(t_1) = \text{cl}(V_1 - N(t_1))$  and  $X = E(t_1) \cup N(D_2)$ . Then  $X$  is homeomorphic to the exterior of the knot  $K$  in  $M$ . We take an essential loop  $m$  on the annulus  $\partial N(t_1) - H$ .  $D_1$  gives a compressing disc of the surface  $\partial E(t_1) - m$  in  $E(t_1)$ . The torus  $\partial X$  has a compressing disc since  $K$  is a core knot. By the generalized handle addition theorem (Theorem 1 (a) in [38]), either  $\partial E(t_1) - (\partial D_2 \cup m)$

has a compressing disc in  $E(t_1)$ , or  $\partial E(t_1) - \partial D_2$  has a compressing disc  $D$  in  $E(t_1)$  such that  $\partial D \cap m \neq \emptyset$ . In the former case,  $H$  is  $K$ -reducible, which is a contradiction. We consider the latter case. Let  $C_1$  be a cancelling disc of  $t_1$  in  $E(t_1)$ , that is,  $|\partial C_1 \cap m| = 1$ . We take  $C_1$  so that  $C_1 \cap D$  consists of arcs only and  $|C_1 \cap D|$  is minimal over all the cancelling discs of  $t_1$ . Let  $A$  be the annulus obtained from  $H$  by cutting along  $\partial D_2$ .

When the arcs  $\partial C_1 \cap A$  separate the two points  $\partial t_1$ , we will obtain a contradiction as below. Since  $\partial D \cap m \neq \emptyset$ , between every two adjacent points of  $\partial D \cap m$  on  $\partial D$ , there is an intersection point of  $\partial D \cap \partial C_1$ . Hence there is an outermost arc  $\alpha$  of  $C_1 \cap D$  on  $D$  such that  $\alpha$  cuts off an outermost disc  $Q$  from  $D$  with  $|\partial Q \cap m| = 0$  or  $1$ . The arc  $\alpha$  divides  $C_1$  into two discs  $C$  and  $C'$  where  $|\partial C \cap m| = 1$ . When  $|\partial Q \cap m| = 1$ , the cancelling disc  $Q \cup C'$  intersects  $D$  in less number of arcs than  $C_1$  does, which is a contradiction. When  $|\partial Q \cap m| = 0$ , we obtain a contradiction again, considering  $C \cup Q$ .

When  $\partial C_1 \cap A$  does not separate  $\partial t_1$ , there is an arc, say  $\alpha$ , on  $A$  such that  $\alpha$  is contained in  $A$ , connects the two points  $\partial t_1$  and is disjoint from  $\text{int}(\partial C_1 \cap H)$ . We can take a cancelling disc  $C_2$  of  $t_2$  in  $(V_2, t_2)$  so that  $\partial C_2 = \alpha$  by Lemma 2.5. Then  $\partial C_2 \cap \partial C_1 = K \cap H$ , and  $K$  has a 1-bridge diagram with no crossings on  $H$ .

The loop  $K' = (\partial C_1 \cup \partial C_2) \cap H$  is of non-meridional slope of the solid tori  $V_1$  and  $V_2$ . Otherwise,  $K$  would be the trivial knot. If  $K'$  is of non-longitudinal slope of  $V_1$  and  $V_2$ , then the exterior of  $K$  is a Seifert fibred space over a disc with two exceptional points, which contradicts it is a solid torus. Hence  $K'$  is of a longitudinal slope of  $V_1$  or  $V_2$ , say  $V_1$  and we can take a meridian disc  $R_1$  of  $V_1$  such that  $R_1$  intersects  $K'$  in a single point and that the intersection point is contained in  $\partial C_2$ . A standard innermost loop and outermost arc argument allows us to isotope  $\text{int } R_1$  so that  $R_1$  is disjoint from the cancelling disc  $C_1$ . □

Weakly  $K$ -reducibility of 1-genus 1-bridge splittings is shown in Theorem 8.2 in [25] for 2-bridge knots. For composite knots, it is essentially shown in Theorem 1.6 in [6]. See also Theorem II in [14].

#### 4. General case

We begin to prove Theorems 1.2 and 1.3. This proof is completed at the end of Section 13. Let  $M$  be the 3-sphere or a lens space, and  $K$  a knot in  $M$ . Let  $H_i$  be a torus giving a 1-genus 1-bridge splitting  $(M, K) = (V_{i1}, t_{i1}) \cup_{H_i} (V_{i2}, t_{i2})$  for  $i = 1$  and  $2$ . We assume that  $H_1$  and  $H_2$  intersect transversely in non-empty collection of loops which are  $K$ -essential on both  $H_1$  and  $H_2$ . If a loop  $l$  of  $H_1 \cap H_2$  is inessential on one of  $H_1$  and  $H_2$ , say on  $H_1$ , then  $l$  bounds a disc intersecting  $K$  transversely in two points on  $H_1$ . Each of  $H_1$  and  $H_2$  contains zero or even number of essential loops of  $H_1 \cap H_2$  since the splitting tori are separating in  $M$ .

The goal of this section is the next proposition.

**Proposition 4.1.** *Suppose that the loops  $H_1 \cap H_2$  contains three parallel loops on  $H_1 - K$  or  $H_2 - K$ , say  $H_2 - K$ . Then one of the following three conditions holds.*

- (1) *We can isotope  $H_1$  and  $H_2$  in  $(M, K)$  so that they intersect in non-empty collection of smaller number of loops which are  $K$ -essential on both  $H_1$  and  $H_2$ . Moreover, we can decrease the number of the intersection loops by two or more.*
- (2) *The splitting  $H_1$  is  $K$ -reducible.*
- (3) *The splitting  $H_1$  has a satellite diagram of non-meridional and non-longitudinal slope. Moreover, a loop of  $H_1 \cap H_2$  gives the slope of the satellite diagram.*

To prove this proposition, we need the next three lemmas. We use the basic lemmas in Appendix A.

In general, let  $X$  be a 3-manifold, and  $T$  a 1-manifold properly embedded in  $X$ . Let  $F_1$  and  $F_2$  be 2-manifolds embedded in  $X$  so that  $F_1 \cap F_2 = \partial F_1 = \partial F_2$ . We say  $F_1$  and  $F_2$  are  $T$ -parallel if the 2-manifold  $F_1 \cup F_2$  bounds a submanifold  $M$  of  $X$  such that the triple  $(M, F_1, T \cap M)$  is homeomorphic to the triple  $(F_1 \times [0, 1], F_1 \times \{0\}, P \times [0, 1])$ , where  $P$  is a union of finite number of points in  $\text{int } F_1$ .

**Lemma 4.2.** *Suppose that one of  $V_{11}$  and  $V_{12}$ , say  $V_{11}$  contains a component  $S$  of  $H_2 \cap V_{11}$  such that  $S$  is  $K$ -parallel to a subsurface  $S'$  of  $\partial V_{11}$ . Suppose that  $H_1 \cap H_2$  consists of larger number of loops than  $|\partial S|$ . Then we can isotope  $H_1$  and  $H_2$  in  $(M, K)$  so that  $H_1$  and  $H_2$  intersect in non-empty collection of smaller number of loops which are  $K$ -essential on both  $H_1$  and  $H_2$ . Moreover, if  $S$  is an annulus disjoint from  $K$ , then we can decrease the number of intersection loops by two or more.*

*Proof.* Suppose that  $\text{int } S'$  is disjoint from  $H_2$ . Then we isotope  $H_2$  near  $S$  slightly beyond  $S'$  along the parallelism, to cancel the intersection loops  $\partial S$ . Since  $|H_1 \cap H_2| > |\partial S|$  before this isotopy,  $H_1 \cap H_2 \neq \emptyset$  after the isotopy. If  $S$  is an annulus, then we have decreased  $|H_1 \cap H_2|$  by two.

Suppose  $(\text{int } S') \cap H_2 \neq \emptyset$ . Then we isotope  $S'$  very closely to  $S$  along the parallelism to cancel the intersection curves  $(\text{int } S') \cap H_2$ . The loops  $\partial S$  remain to be intersection loops of  $H_1 \cap H_2$ . We consider the case where  $S$  is an annulus disjoint from  $K$ . If  $\text{int } S'$  intersects  $H_2$  in two or more loops, then we have decreased the number of the intersection loops by two or more. Suppose for a contradiction that  $\text{int } S'$  intersects  $H_2$  in a single loop  $c$ . Since  $c$  is  $K$ -essential in  $H_1$ , it is essential in the annulus  $S'$ , and bounds a surface in the parallelism between  $S$  and  $S'$ . This is a contradiction since  $c$  generates the homology group of the solid torus of parallelism. □

Recall that we consider the general case where  $H_1 \cap H_2$  contains three parallel loops  $l_1, l_2, l_3$ , appearing in this order, on  $H_2 - K$ . (They may be essential or inessential on  $H_2$ .) Let  $A_1$  and  $A_2$  be the annuli on  $H_2 - K$  between  $l_1$  and  $l_2$  and between  $l_2$  and  $l_3$  respectively. We can assume, without loss of generality, that  $A_i$  is contained

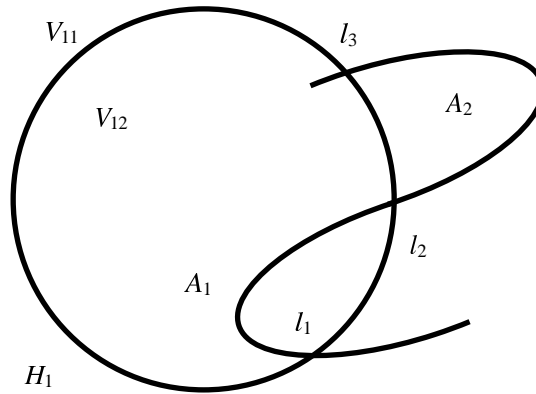

Fig. 4.1.

in  $V_{1i}$  for  $i = 1$  and  $2$ . See Fig. 4.1.

**Lemma 4.3.** *Suppose that at least one of  $A_1$  and  $A_2$ , say  $A_1$ , has boundary loops which are inessential in  $H_1$ . Then one of the two conditions below holds.*

- (1)  $A_i$  is  $K$ -parallel in  $(V_{1i}, t_{1i})$  to an annulus on  $H_1$  for  $i = 1$  or  $2$ .
- (2)  $K$  is the trivial knot.

*Proof.* We apply Lemma A.3 in Appendix A to  $A_1$  in  $(V_{11}, t_{11})$ . (1) of Lemma A.3 implies (1) of this lemma. Hence we can assume that (2) of Lemma A.3 holds. Then there is a cancelling disc, say  $C_1$ , of  $t_{11}$  such that  $\partial C_1 \cap H_1$  is contained in the disc, say  $Q$ , bounded by the outermost loop among  $l_1$  and  $l_2$  on  $H_1$ .

Since  $l_2$  is inessential on  $H_1$ , by Lemmas A.2 and A.3, either  $A_2$  is  $K$ -parallel in  $(V_{12}, t_{12})$  to an annulus in  $H_1$ , or there is a cancelling disc  $C_2$  of  $t_{12}$  in  $(V_{12}, t_{12})$  with  $\partial C_2 \cap H_1 \subset Q$ . In the former case, we obtain the conclusion (1). In the latter case, the knot  $K$  has a 1-bridge diagram on the disc  $Q$ , and hence is the trivial knot.  $\square$

**Lemma 4.4.** *Suppose that one component of  $\partial A_1$  is essential and the other is inessential on  $\partial V_{11}$ . Then one of the two conditions below holds.*

- (1)  $A_2$  is  $K$ -parallel in  $(V_{12}, t_{12})$  to an annulus in  $H_1$ .
- (2) The splitting  $H_1$  is  $K$ -reducible.

*Proof.* We assume that the conclusion (1) does not occur to show that (2) occurs. Then, applying Lemmas A.1, A.2 and A.3 to  $A_2$  in  $(V_{12}, t_{12})$ , there is a cancelling disc  $C_2$  of  $t_{12}$  with  $C_2 \cap \partial A_2 = \emptyset$ . By Lemma A.2 a component of  $\partial A_1$  bounds a meridian disc  $D$  disjoint from  $K$  in  $V_{11}$ . If  $\partial A_2$  contains  $\partial D$ , then  $H_1$  is  $K$ -reducible since  $C_2 \cap \partial D = \emptyset$ . If a component  $l$  of  $\partial A_2$  is inessential on  $H_1$ , then the arc  $\partial C_2 \cap H_1$  is contained in the disc bounded by  $l$  on  $H_1$ , and hence  $\partial C_2$  is disjoint from  $\partial D$ . Thus

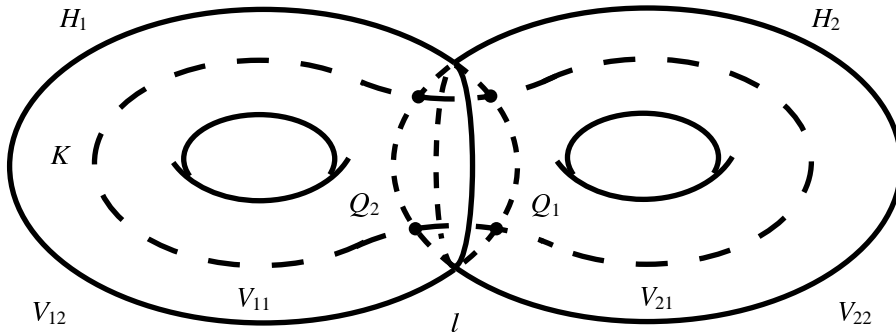

Fig. 5.1.

$H_1$  is  $K$ -reducible. □

Proof. We prove Proposition 4.1. (1) of Lemma 4.3 and (1) of Lemma 4.4 imply (1) of this proposition together with Lemma 4.2 since  $H_1 \cap H_2$  contains three or more loops. (2) of Lemma 4.3 implies (2) of this proposition by Theorem B in [13]. (2) of Lemma 4.4 is contained in (2) of this proposition.

Hence we can assume that the loops of  $\partial A_1$  and  $\partial A_2$  are essential in  $H_1$ . If at least one of  $A_1$  and  $A_2$ , say  $A_1$ , is  $K$ -parallel in  $(V_{11}, t_{11})$  to an annulus in  $H_1$ , then we obtain the conclusion (1) by Lemma 4.2 since  $H_1 \cap H_2$  consists of three or more loops. Then we can assume that the annuli are not  $K$ -parallel into  $H_1$ , and that  $\partial A_i$  is of non-longitudinal slope of  $V_{1i}$  for  $i = 1$  and  $2$  by Lemma A.1. Hence there is a cancelling disc  $C_i$  of  $t_i$  in  $(V_{1i}, t_{1i})$  with  $\partial C_i \cap \partial A_i = \emptyset$  for  $i = 1$  and  $2$ .  $l_1$ ,  $l_2$  and  $l_3$  together divide  $H_1$  into three annuli, one of which, say  $R$ , contains the two points  $K \cap H_1$ . We can isotope  $C_1$  and  $C_2$  near their boundary so that the arcs  $\partial C_1 \cap H_1$  and  $\partial C_2 \cap H_1$  are contained in  $R$ . This implies that  $H_1$  admits a satellite diagram of a non-longitudinal slope. If the slope of the satellite diagram is meridional, then  $K$  is the trivial knot, and  $H_1$  is  $K$ -reducible by Lemma 3.3. This completes the proof of the proposition. □

**5. When  $|H_1 \cap H_2| = 1$**

In this section, we study the case where  $H_1$  and  $H_2$  intersect each other in a single loop  $l$ . We are going to use the basic lemmas in Appendix B. Since  $1$  is odd,  $l$  is inessential and  $K$ -essential in both  $H_1$  and  $H_2$ .  $l$  bounds a disc, say  $Q_i$ , intersecting  $K$  in two points in  $H_i$  for  $i = 1$  and  $2$ . See Fig. 5.1.

For  $(i, j) = (1, 2)$  and  $(2, 1)$ ,  $Q_i$  is contained in  $V_{j1}$  or  $V_{j2}$ , say  $V_{j1}$ , and forms a 2-sphere bounding a 3-ball  $B$  together with  $Q_j$  in the solid torus  $V_{j1}$ .  $K$  intersects  $B$  in two subarcs each of which connects  $Q_i$  and  $Q_j$ . Set  $V'_{j1} = \text{cl}(V_{j1} - B)$  and  $t'_{j1} = t_{j1} \cap V'_{j1}$  for  $j = 1$  and  $2$ . Note that  $t'_{j1} = t_{i2}$  for  $(i, j) = (1, 2)$  and  $(2, 1)$ .

By Lemma 2.10,  $Q_i$  is  $K$ -compressible or  $K$ - $\partial$ -compressible in  $(V_{j1}, t_{j1})$ . Hence it is sufficient to consider the four cases (1), (2), (3)(a), (3)(b) below.

- (1)  $Q_i$  is  $K$ -compressible in  $(V_{j1}, t_{j1})$  for  $(i, j) = (1, 2)$  and  $(2, 1)$ .
- (2)  $Q_1$  or  $Q_2$ , say  $Q_1$  is  $K$ -incompressible in  $(V_{21}, t_{21})$ ,  $K$ - $\partial$ -incompressible in  $(V'_{21}, t'_{21})$  and  $K$ - $\partial$ -compressible in  $(B, K \cap B)$ .
- (3)  $Q_1$  or  $Q_2$ , say  $Q_1$  is  $K$ -incompressible in  $(V_{21}, t_{21})$  and is  $K$ - $\partial$ -compressible in  $(V'_{21}, t'_{21})$ . There are two subcases.

- (a)  $Q_2$  is  $K$ -compressible in  $(V_{11}, t_{11})$ .
- (b)  $Q_2$  is  $K$ -incompressible in  $(V_{11}, t_{11})$  and  $K$ - $\partial$ -compressible in  $(V'_{11}, t'_{11})$ .

We do not need to consider the subcase where  $Q_2$  is  $K$ -incompressible in  $(V_{11}, t_{11})$ ,  $K$ - $\partial$ -incompressible in  $(V'_{11}, t'_{11})$  and  $K$ - $\partial$ -compressible in  $(B, K \cap B)$ , since this case is contained in the case (2).

**Lemma 5.1.** *In case (1)  $H_2$  is  $K$ -reducible.*

Proof. Since  $Q_1$  is  $K$ -compressible in  $(V_{21}, t_{21})$ ,  $\partial Q_2$  bounds a  $K$ -compressing disc  $D$  of  $H_2$  in  $(V_{21}, t_{21})$  by Lemma B.1 in Appendix B. Let  $D'$  be a  $K$ -compressing disc of  $Q_2$  in  $(V_{11}, t_{11})$ . By Lemma B.1(1),  $D'$  is contained in  $V'_{11} = V_{11} \cap V_{22}$ . Then  $D$  and  $D'$  show that  $H_2$  is  $K$ -reducible. □

**Lemma 5.2.** *In case (3)(a)  $K$  is isotopic to a core of  $V_{21}$  in  $M$ .*

Proof. Since  $Q_2$  is  $K$ -compressible in  $(V_{11}, t_{11})$ , by Lemma B.1 (2), there is a cancelling disc  $C$  of  $t_{11}$  in  $(V_{11}, t_{11})$  with  $C \cap H_1 \subset Q_1$ . Let  $D$  be a  $K$ - $\partial$ -compressing disc of  $Q_1$  in  $(V'_{21}, t'_{21})$ . By Lemma B.3 (1)  $D$  is a meridian disc of  $V'_{21}$ , and by Lemma B.3 (4) there is a cancelling disc  $P$  of  $t'_{21}$  in  $(V'_{21}, t'_{21})$  such that  $P$  is disjoint from  $D$  and that  $P \cap Q_1$  consists of two arcs each of which contains a point of  $\partial t'_{21}$ . Since  $K$  intersects  $Q_1$  in precisely two points, we can take  $C$  and  $P$  so that  $\partial C \cap \partial D$  is a single point and that  $\partial C \cap \partial P = K \cap Q_1$ . Hence  $K$  is isotopic to the circle  $(\partial C \cup \partial P) \cap \partial V'_{21}$ , and is isotopic to a core of  $V_{21}$ . □

**Lemma 5.3.** *In case (3)(b)  $H_j$  is isotopic to the torus obtained by performing a tubing operation on  $\partial B$  along  $t_{i2}$  for  $(i, j) = (1, 2)$  and  $(2, 1)$ . Moreover,  $(B, K \cap B)$  is a trivial 2-string tangle, and its complementary tangle  $(X, S)$  with  $X = \text{cl}(M - B)$  and  $S = K \cap X$  is as below.*

- (i)  $X$  is a ball or a once punctured lens space and  $S$  is a disjoint union of two arcs  $s_1$  and  $s_2$ ,
- (ii)  $E_i = \text{cl}(X - N(s_i))$  is a solid torus for  $i = 1$  and  $2$  and
- (iii)  $s_j$  is trivial in  $E_i$  for  $(i, j) = (1, 2)$  and  $(2, 1)$ .

*In particular,  $K$  is the trivial knot or a 2-bridge knot when  $M = S^3$ .*



**Proof.** For  $(i, j) = (1, 2)$  and  $(2, 1)$ , we consider the arguments below. Let  $D_j$  be a  $K$ - $\partial$ -compressing disc of  $Q_i$  in  $(V'_{j1}, t'_{j1})$ . The arc  $D_j \cap Q_i$  separates the two points  $K \cap Q_i$  in  $Q_i$ . Let  $N(D_j)$  be a regular neighbourhood of  $D_j$  in  $V'_{j1}$  and set  $B' = B \cup N(D_1) \cup N(D_2)$ . Then  $B'$  is a ball isotopic to  $B$  in  $(M, K)$ . Set  $X = \text{cl}(M - B')$ ,  $s_j = t'_{j1} = t_{j2}$  and  $S = s_1 \cup s_2$ . The ball  $N_j = \text{cl}(V'_{j1} - N(D_j))$  forms a regular neighbourhood of  $s_j$  in  $X$  by Lemma B.3. Hence  $H_j$  is isotopic in  $(M, K)$  to the torus obtained by performing a tubing operation on  $\partial B$  along  $t_{j2}$ . Since  $V_{j1} \cup B'$  is a solid torus isotopic to  $V_{j1}$  in  $(M, K)$ , the exterior  $E_j = \text{cl}(X - N_j)$  of  $s_j$  is isotopic to the solid torus  $V_{j2}$ .

We can take a cancelling disc  $C_j$  of  $t_{j2}$  in  $(V_{j2}, t_{j2})$  with  $C_j \cap D_i = \emptyset$ . Then  $C_j$  is also a cancelling disc of  $s_i = t_{j2}$  in  $E_j = \text{cl}(X - N_j)$ . Since the tangle  $(B', K \cap B')$  is isotopic to  $(B, K \cap B)$  in  $(M, K)$ , and since  $(B, K \cap B)$  is a trivial 2-string tangle by Lemma B.2 (3),  $(B', K \cap B')$  is a trivial 2-string tangle.

When  $M = S^3$ ,  $X$  is a ball,  $\text{cl}(X - N_1)$  and  $\text{cl}(X - N_2)$  are solid tori, and  $\text{cl}(X - N_1 \cup N_2)$  is a handlebody because  $s_1$  is trivial in  $E_2$ . Hence  $(X, S)$  is a trivial 2-string tangle by Theorem 1 in [10]. Thus  $K$  is the trivial knot or a 2-bridge knot. □

**Lemma 5.4.** *Assume that  $(B, K \cap B)$  is a trivial 2-string tangle. Suppose that the once punctured torus  $H_2 \cap V_{12}$  or  $H_1 \cap V_{22}$ , say  $H_2 \cap V_{12}$  is compressible in  $V_{12} \cap V_{22}$ . Then  $M = S^3$  and  $K$  is the trivial knot or a 2-bridge knot.*

**Proof.** Let  $D$  be a compressing disc of  $H_2 \cap V_{12}$  in  $V_{12} \cap V_{22}$ . Note that  $V_{12} \cap V_{22}$  is disjoint from  $K$ . We perform a compressing operation on a copy of  $H_2 \cap V_{12}$  along  $D$ . Then we obtain a disc  $D'$  (and possibly a torus component) with  $\partial D' = \partial Q_i$ . The 2-sphere  $D' \cup Q_i$  bounds a ball  $W_i$  in  $V_{i2}$  for  $i = 1$  and  $2$ . Moreover,  $t_{i2}$  is trivial in  $W_i$  by Lemma 2.1 for  $i = 1$  and  $2$ . Then  $(W_1 \cup_{D'} W_2, t_{12} \cup t_{22})$  is a trivial 2-string tangle, and hence  $K$  is the trivial knot or a 2-bridge knot. □

**Lemma 5.5.** *In case (2) either  $K$  is the trivial knot or a 2-bridge knot in  $S^3$ , or we can isotope  $H_1$  in  $(M, K)$  so that*

- (i)  $H_1 \cap H_2$  consists of two essential loops on both  $H_1$  and  $H_2$ ,
- (ii)  $H_1 \cap H_2$  divide  $H_i$  into two annuli one of which, say  $A_i$ , intersects  $K$  in two points for  $i = 1$  and  $2$  and
- (iii) there is a parallelism  $(P, K \cap P)$  of  $A_1$  and  $A_2$  with  $(\text{int } P) \cap (H_1 \cup H_2) = \emptyset$ .

**Proof.** In case (2),  $(B, K \cap B)$  gives a parallelism between  $Q_1$  and  $Q_2$  by Lemma B.4. Suppose first that  $H_2 \cap V_{12}$  has a  $K$ -compressing disc  $D$  in  $(V_{12}, t_{12})$ . Then by Lemma B.2 (4)  $D$  is contained in  $V_{12} \cap V_{22}$ . By Lemma B.2 (3),  $(B, K \cap B)$  is a trivial 2-string tangle, and hence  $K$  is the trivial knot or a 2-bridge knot in  $S^3$  by Lemma 5.4.

Hence we can assume that  $H_2 \cap V_{12}$  is  $K$ -incompressible in  $(V_{12}, t_{12})$ . Then  $H_2 \cap V_{12}$  has a  $K$ - $\partial$ -compressing disc  $R$  in  $(V_{12}, t_{12})$  by Lemma 2.10. If  $R$  is contained

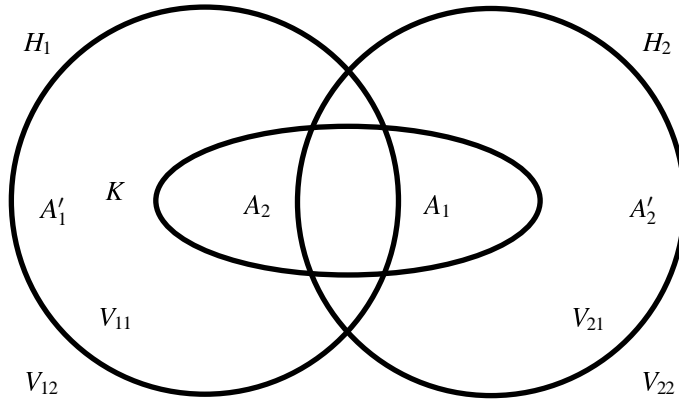

Fig. 5.2.

in  $V'_{21}$ , then  $R \cap Q_1$  is an arc essential in  $Q_1 - K$  by the unusual definition of  $K$ - $\partial$ -compressibility. Hence  $R$  is also a  $K$ - $\partial$ -compressing disc of  $Q_1$ , which contradicts that we are now considering case (2). Then  $R$  is contained in  $V_{12} \cap V_{22}$ . The arc  $R \cap (H_1 \cap V_{22})$  is essential in  $H_1 \cap V_{22}$  by the definition of  $K$ - $\partial$ -compressibility. We isotope  $H_2$  along  $R$ , and obtain the desired conclusion.  $\square$

In the rest of this section, we consider the latter half of the conclusion of Lemma 5.5, that is, we assume that the conditions (i), (ii) and (iii) are satisfied. See Fig. 5.2. Set  $A'_i = \text{cl}(H_i - A_i)$  for  $i = 1$  and  $2$ . Let  $V_{i1}$  be the solid torus bounded by  $H_i$  and containing the annulus  $A_j$  for  $(i, j) = (1, 2)$  and  $(2, 1)$ . Let  $V_{i2}$  be the other solid torus bounded by  $H_i$  in  $M$ . Set  $t_{ij} = K \cap V_{ij}$ . Let  $V'_{i1}$  be the solid torus  $V_{i1} - P$ , and let  $t'_{i1} = K \cap V'_{i1}$  for  $i = 1$  and  $2$ . In  $(V_{j2}, t_{j2})$  the annulus  $A'_i$  is  $K$ -compressible or  $K$ - $\partial$ -compressible by Lemma 2.10. Hence there are five cases (A), (B), (C), (D)(i), (D)(ii) below.

- (A) One of  $A'_1$  and  $A'_2$ , say  $A'_1$  has a  $K$ -compressing disc in  $V_{12} \cap V_{22}$ .
- (B)  $A'_1$  and  $A'_2$  are  $K$ -compressible in  $(V'_{11}, t'_{11})$  and in  $(V'_{21}, t'_{21})$  respectively.
- (C) One of  $A'_1$  and  $A'_2$ , say  $A'_1$  has a  $K$ - $\partial$ -compressing disc in  $V_{12} \cap V_{22}$ .
- (D) One of  $A'_1$  and  $A'_2$ , say  $A'_1$  is  $K$ - $\partial$ -compressible in  $(V'_{11}, t'_{11})$ . There are two sub-cases.
  - (i)  $A'_2$  is  $K$ -compressible in  $(V'_{21}, t'_{21})$ .
  - (ii)  $A'_2$  is  $K$ - $\partial$ -compressible in  $(V'_{21}, t'_{21})$ .

**Lemma 5.6.** *In case (A),  $K$  is the trivial knot.*

*Proof.* A  $K$ -compressing operation on a copy of  $A'_1$  in  $V_{12} \cap V_{22}$  yields meridian discs  $D_1$  and  $D_2$  of  $V_{12}$  and  $V_{22}$ . By Lemma A.1, there is a cancelling disc  $C_i$  of  $t_{i2}$  disjoint from  $D_1$  and  $D_2$  in  $(V_{i2}, t_{i2})$  for  $i = 1$  and  $2$ . Then  $\partial C_i \cap H_i \subset A_i$ . Since  $A_1$

and  $A_2$  are  $K$ -parallel in  $(P, K \cap P)$ , we can extend  $C_2$  to a cancelling disc  $C'_2$  of  $t_{11}$  in  $(V_{11}, t_{11})$  with  $\partial C_1 \cap H_1 \subset A_1$ . Thus  $K$  admits a 1-bridge diagram on  $A_1$ . (Note that  $C'_2$  may intersect  $A'_1$ .) Since  $\partial A_1$  is meridional on  $\partial V_{12}$ ,  $A_1$  is an unknotted and untwisted annulus, and  $K$  is the trivial knot.  $\square$

**Lemma 5.7.** *In case (C),  $H_1$  and  $H_2$  are isotopic in  $(M, K)$ .*

*Proof.* Let  $D$  be a  $K$ - $\partial$ -compressing disc of  $A'_1$  with  $D \subset V_{12} \cap V_{22}$ . The arc  $\partial D \cap A'_1$  connects two distinct components of  $\partial A'_1$ . Hence the arc  $\partial D \cap A'_2$  is also essential in  $A'_2$ . If we perform a  $K$ - $\partial$ -compressing operation on  $A'_1$  along  $D$ , then we obtain a disc whose boundary bounds a disc on  $A'_2$ . These discs together form a 2-sphere bounding a ball in  $V_{12}$ . Thus  $V_{12} \cap V_{22}$  gives a  $K$ -parallelism between  $A'_1$  and  $A'_2$  in  $(M, K)$ . Since  $(P, K \cap P)$  gives  $K$ -parallelism between  $A_1$  and  $A_2$ ,  $H_1$  and  $H_2$  are isotopic in  $(M, K)$ .  $\square$

**Lemma 5.8.** *In case (D)(ii), there is an annulus  $A$  embedded in  $M$  satisfying the following two conditions (a) and (b).*

- (a) *A core loop of  $A$  forms a core knot in  $M$ .*
- (b)  *$K$  has a 1-bridge diagram on  $A$ . That is,  $K$  intersects  $A$  transversely in two points and is divided into two subarcs  $t_1$  and  $t_2$ , and there is an embedded disc  $C_i$  with  $K \cap C_i = t_i \subset \partial C_i$   $\text{cl}(\partial C_i - t_i) = C_i \cap \text{int } A$  and  $C_1 \cap C_2 \subset \text{int } A$  for  $(i, j) = (1, 2)$  and  $(2, 1)$ .*

*Moreover, let  $R_i$  be the annulus obtained by isotoping  $A$  fixing  $\partial A$  along  $C_i$  slightly beyond  $t_i$ . Then  $H_i$  is isotopic to the torus  $A \cup R_i$  in  $(M, K)$  for  $i = 1$  and  $2$ , after changing suffix numbers if necessary.*

*Proof.* For  $(i, j) = (1, 2)$  and  $(2, 1)$ , we consider the argument below. Since the annulus  $A'_i$  is disjoint from the knot  $K$ , performing  $K$ - $\partial$ -compressing operation on a copy of  $A'_i$ , we obtain a disc  $Q_i$  such that  $\partial Q_i$  bounds a disc  $Q'_i$  on  $A_j$ . The 2-sphere  $Q_i \cup Q'_i$  bounds a ball  $B_i$  in  $V_{j2}$ . Hence  $A'_i$  and  $A_j$  are parallel in  $M$  (ignoring  $K$ ). A standard innermost loop and outermost arc argument allows us to take a cancelling disc  $C_{j2}$  of  $t_{j2}$  in  $(V_{j2}, t_{j2})$  with  $C_{j2} \cap Q_i = \emptyset$ . Since  $A_1$  and  $A_2$  are  $K$ -parallel in  $(P, K \cap P)$ , we have the desired conclusion.  $\square$

**Lemma 5.9.** *In case (B), we have a contradiction.*

*Proof.* A  $K$ -compressing operation on  $A'_1$  yields meridian discs  $D_1$  and  $D_2$  of  $V_{22}$ . Since  $A'_2$  has a  $K$ -compressing disc in  $V'_{21}$ ,  $M \cong S^2 \times S^1$ , which contradicts our assumption.  $\square$

**Lemma 5.10.** *In case (D)(i),  $H_2$  is  $K$ -reducible.*

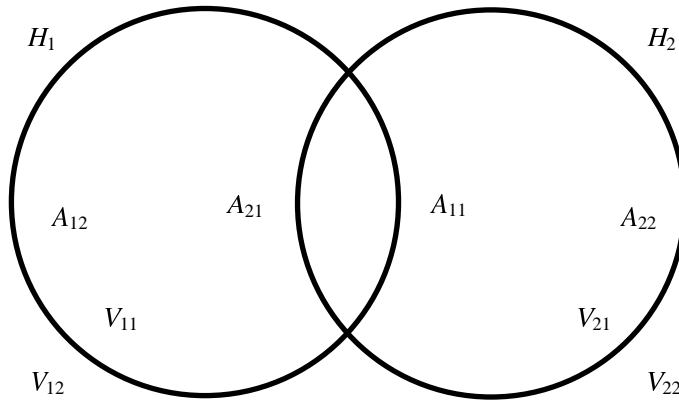

Fig. 6.1.

Proof. Performing a  $K$ - $\partial$ -compressing operation on  $A'_1$ , we obtain a  $K$ -compressing disc of  $A_2$ , which is peripheral in  $V_{22}$  (ignoring  $t_{22}$ ). This disc and a  $K$ -compressing disc of  $A'_2$  in  $V_{21}$  show that  $H_2$  is  $K$ -reducible.  $\square$

## 6. When $H_1 \cap H_2$ consists of two essential loops (I)

In this and the next sections, we consider the case where  $H_1 \cap H_2$  consists of two loops which are essential on both  $H_1$  and  $H_2$  (ignoring the points  $K \cap H_i$ ).

See Fig. 6.1. The loops  $H_1 \cap H_2$  divide  $H_i$  into two annuli  $A_{i1}$  and  $A_{i2}$  for  $i = 1$  and 2. Let  $V_{i1}$  be the solid torus bounded by  $H_i$  in  $M$  with  $A_{j1} \subset V_{i1}$  for  $(i, j) = (1, 2)$  and  $(2, 1)$ . Let  $V_{i2}$  be the other solid torus bounded by  $H_i$ . Set  $t_{ij} = K \cap V_{ij}$ .

**Lemma 6.1.**  $A_{11}, A_{12}, A_{21}, A_{22}$  are parallel to an annulus in the boundary of  $V_{21}, V_{22}, V_{11}, V_{12}$  respectively (ignoring  $K$ ). Hence these solid tori are divided the annuli into two solid tori.

Proof. In this proof we ignore  $K$ . We consider  $A_{11}$ . The same argument will do for the other annuli.

We can assume that  $\partial A_{11}$  are of meridional slope of  $V_{21}$ . (Otherwise, the conclusion is a well-known fact.) Then  $A_{11}$  is compressible in  $V_{21}$ . Moreover, we can assume, without loss of generality, that  $A_{11}$  has a compressing disc  $Q$  in  $V_{21} \cap V_{12}$ . Then, compressing  $A_{11}$ , we obtain a compressing disc  $R$  of  $A_{22}$  in  $V_{21} \cap V_{12}$ .  $\partial Q$  is of meridional slope of  $V_{12}$ , and hence it is of non-meridional slope of  $V_{11}$ , otherwise,  $M \cong S^1 \times S^2$ . Hence  $A_{21}$  is parallel to one of  $A_{11}$  and  $A_{12}$  in  $V_{11}$ . When  $A_{21}$  is parallel to  $A_{11}$ , we are done. Hence we can assume that  $A_{21}$  is parallel to  $A_{12}$ . Then we can isotope  $H_1$  into  $\text{int } V_{21}$  so that it is disjoint from the meridian disc  $R$  of  $V_{21}$ . Let  $S$  be the 2-sphere obtained by compressing  $H_2$  along  $R$ .  $S$  bounds a ball containing  $H_1$

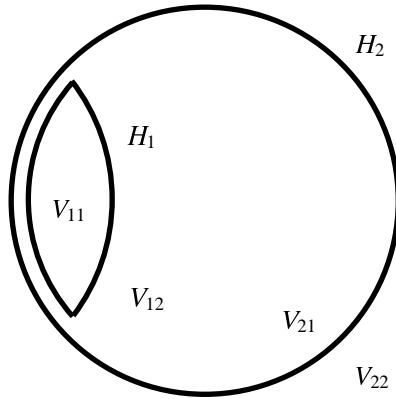

Fig. 6.2.

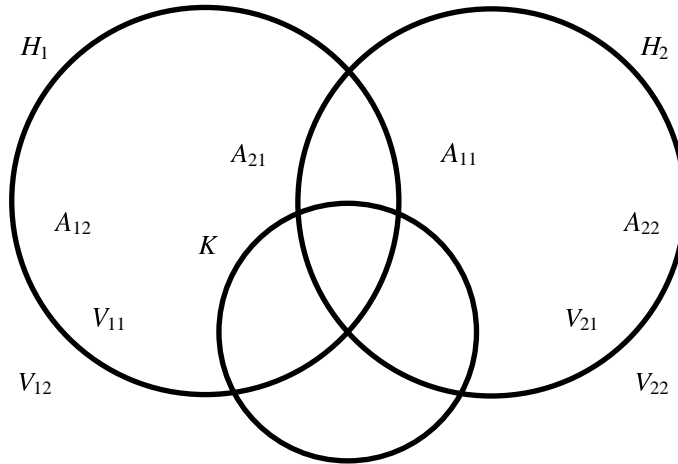

Fig. 6.3.

in  $V_{21}$ , and on the other side bounds a ball in  $V_{12}$ . See Fig. 6.2. Hence  $M = S^3$ , and  $\partial A_{21}$  is of longitudinal slope of  $V_{11}$  before the isotopy of  $H_1$ . Hence  $A_{21}$  is parallel to  $A_{11}$  in  $V_{11}$ .  $\square$

We can assume, without loss of generality, that  $|A_{i1} \cap K| \geq |A_{i2} \cap K|$ . There are two cases: in case (I)  $|A_{11} \cap K| = |A_{21} \cap K| = |A_{12} \cap K| = |A_{22} \cap K| = 1$  (See Fig. 6.3), and in case (II)  $|A_{11} \cap K| = |A_{21} \cap K| = 2$  and  $A_{12} \cap K = A_{22} \cap K = \emptyset$ . We consider case (I) in this section, and case (II) in the next section. In this section, we will use lemmas in Appendix C.

When  $A_{ik}$  has a  $K$ - $\partial$ -compressing disc  $D$  in  $(V_{jk}, t_{jk})$  for  $(i, j) = (1, 2)$  or  $(2, 1)$

and  $k \in \{1, 2\}$ , we say that  $D$  is *essential* if the arc  $\partial D \cap A_{ik}$  is essential on  $A_{ik}$ , and *inessential* otherwise, following the definition in Appendix C.

There are many cases as below.

- (1) Precisely one of the four solid tori  $V_{11} \cap V_{21}$ ,  $V_{11} \cap V_{22}$ ,  $V_{12} \cap V_{21}$  and  $V_{12} \cap V_{22}$  contains an essential  $K$ - $\partial$ -compressing disc (Lemma 6.6).
- (2) Precisely two adjacent solid tori do (Lemma 6.5).
- (3) Two non-adjacent solid tori do (Lemma 6.4).
- (4) None of the solid tori does. There are 2 subcases.
  - (a) At least one of  $A_{11}$ ,  $A_{12}$ ,  $A_{21}$ ,  $A_{22}$  is  $K$ -compressible (Lemma 6.2).
  - (b) All of the annuli are  $K$ -incompressible, and hence have inessential  $K$ - $\partial$ -compressing discs (Lemma 6.3).

**Lemma 6.2.** *Suppose that  $A_{ik}$  is  $K$ -compressible in  $(V_{jk}, t_{jk})$  and  $A_{il}$  does not have an essential  $K$ - $\partial$ -compressing disc in  $(V_{jl}, t_{jl})$  for  $(i, j) = (1, 2)$  or  $(2, 1)$  and  $(k, l) = (1, 2)$  or  $(2, 1)$ . Then  $H_j$  is weakly  $K$ -reducible.*

*Proof.* Suppose, without loss of generality, that the preliminary conditions hold for  $(i, j) = (1, 2)$  and  $(k, l) = (1, 2)$ . Let  $D$  be a  $K$ -compressing disc of  $A_{11}$ . We can assume, without loss of generality, that  $D$  is contained in  $V_{11} \cap V_{21}$ . Then  $A_{21}$  has a  $K$ -compressing disc in  $V_{11} \cap V_{21}$  by Lemma C.1. Moreover,  $\partial A_{11} = \partial A_{21}$  is meridional on  $V_{21}$  and  $V_{11}$ .

First, suppose that  $A_{12}$  is  $K$ -compressible in  $(V_{22}, t_{22})$ . Then  $\partial A_{12}$  is of meridional slope of  $V_{22}$ , and  $M \cong S^2 \times S^1$ , which is a contradiction.

Secondly, suppose that  $A_{12}$  is  $K$ -incompressible in  $(V_{22}, t_{22})$ . Then  $A_{12}$  has a  $K$ - $\partial$ -compressing disc  $D'$  by Lemma 2.10. By the preliminary condition, the arc  $\partial D' \cap A_{12}$  is inessential in  $A_{12}$ . By Lemma C.3, we can take a cancelling disc  $C$  of  $t_{22}$  in  $(V_{22}, t_{22})$  so that  $\partial C$  is disjoint from a component of  $\partial A_{12}$ . ((1) of Lemma C.3 contradicts our assumption in this lemma.) On the other hand, by performing a  $K$ -compressing operation on  $A_{11}$  along  $D$ , we obtain meridian discs, each of which intersects  $K$  at most one point. Hence  $H_2$  is weakly  $K$ -reducible.  $\square$

We introduce the notion of “semi-satellite diagrams”. In general, let  $(M, K) = (V_1, t_1) \cup_H (V_2, t_2)$  be a 1-genus 1-bridge splitting. We say that  $H$  has a *semi-satellite diagram* if there is a pair of disjoint simple loops  $l_1$  and  $l_2$  on  $H$  such that  $l_1$  and  $l_2$  are essential on  $H$  and that  $t_i$  has a cancelling disc  $C_i$  disjoint from  $l_i$  in  $V_i$  for  $i = 1$  and  $2$ . A satellite diagram is a semi-satellite diagram. We call  $l_1$  and  $l_2$  the *slopes* of the semi-satellite diagram. We say that  $l_1$  and  $l_2$  are *meridional* (resp. *longitudinal*) if they are meridional (resp. longitudinal) on  $\partial V_1$  or  $\partial V_2$ .

The next lemma immediately follows from Lemma C.3.

**Lemma 6.3.** *Suppose that  $A_{11}, A_{12}, A_{21}$  and  $A_{22}$  are  $K$ -incompressible in  $(V_{21}, t_{21}), (V_{22}, t_{22}), (V_{11}, t_{11})$  and  $(V_{12}, t_{12})$  respectively. Suppose that two non-adjacent solid tori among  $V_{11} \cap V_{21}, V_{11} \cap V_{22}, V_{12} \cap V_{21}, V_{12} \cap V_{22}$  contain inessential  $K$ - $\partial$ -compressing discs of  $A_{11}, A_{12}, A_{21}, A_{22}$ , and that these solid tori do not contain an essential  $K$ - $\partial$ -compressing disc. Then  $H_i$  has a semi-satellite diagram of non-longitudinal and non-meridional slope for  $i = 1$  and  $2$ . Moreover, the other splitting torus is a union of two annuli as in (2) of Lemma C.3.*

In Section 12, we will study what the conclusion of Lemma 6.3 implies. The next lemma immediately follows from Lemma C.2.

**Lemma 6.4.** *Suppose that two non-adjacent solid tori among  $V_{11} \cap V_{21}, V_{11} \cap V_{22}, V_{12} \cap V_{21}, V_{12} \cap V_{22}$ , say  $V_{11} \cap V_{21}$  and  $V_{12} \cap V_{22}$  contain essential  $K$ - $\partial$ -compressing discs of  $A_{11}, A_{12}, A_{21}, A_{22}$ . Then  $H_1$  and  $H_2$  are isotopic in  $(M, K)$ .*

**Lemma 6.5.** *Suppose that only two adjacent solid tori among  $V_{11} \cap V_{21}, V_{11} \cap V_{22}, V_{12} \cap V_{21}, V_{12} \cap V_{22}$ , say  $V_{12} \cap V_{22}$  and  $V_{11} \cap V_{22}$  contain essential  $K$ - $\partial$ -compressing discs of  $A_{12}, A_{21}, A_{22}$ . Then either*

- (1) *one of  $H_1$  and  $H_2$  is  $K$ -reducible, or*
- (2) *we can isotope  $H_1$  and  $H_2$  so that they are in the situation of the latter half of Section 5 (which is considered in Lemmas 5.6–5.10).*

*Proof.* Suppose that  $A_{11}$  is  $K$ -compressible in  $(V_{21}, t_{21})$ . Then a  $K$ -compressing operation on  $A_{11}$  yields a meridian disc, say  $Q$ , disjoint from  $K$  and bounded by a loop of  $\partial A_{11}$ . Since  $A_{21}$  and  $A_{22}$  are parallel in  $(V_{22}, t_{22})$ , we can take a cancelling disc  $C$  of  $t_{22}$  in  $(V_{22}, t_{22})$  with  $\partial C \cap \partial Q = \emptyset$ . Thus  $H_2$  is  $K$ -reducible.

Hence we can assume that  $A_{11}$  is  $K$ - $\partial$ -compressible by Lemma 2.10. Then one of  $V_{11} \cap V_{21}$  and  $V_{12} \cap V_{21}$ , say  $V_{11} \cap V_{21}$  contains an inessential  $K$ - $\partial$ -compressing disc  $D$  of  $A_{11}$ . Then  $D$  cuts off a ball  $B$  intersecting  $K$  in a single arc, say  $t$ , from  $V_{11} \cap V_{21}$ , and we can take a cancelling disc  $\Delta$  of  $t$  in  $B$  so that each of  $\partial \Delta \cap \partial V_{11}$  and  $\partial \Delta \cap \partial V_{21}$  is a single arc. See Fig. 6.4. We isotope  $K$  near  $t$  along  $\Delta$  slightly beyond the arc  $\partial \Delta - t$ . See Fig. 6.5. Then  $K$  is in the same situation as in the latter half of Section 5, since  $(V_{12} \cap V_{22}, K \cap V_{12} \cap V_{22})$  gives a  $K$ -parallelism between  $A_{12}$  and  $A_{22}$  before the isotopy. Note that this isotopy does not change the isotopy classes of  $H_1$  and  $H_2$  in  $(M, K)$ . □

**Lemma 6.6.** *Suppose that precisely one solid torus among  $V_{11} \cap V_{21}, V_{11} \cap V_{22}, V_{12} \cap V_{21}, V_{12} \cap V_{22}$ , say  $V_{11} \cap V_{21}$  contains an essential  $K$ - $\partial$ -compressing disc of  $A_{11}, A_{21}$ . Then one of the following three conditions holds.*

- (1) *One of  $H_1$  and  $H_2$  is weakly  $K$ -reducible.*
- (2) *We can isotope  $H_1$  and  $H_2$  so that they are in the situation of the latter half of Section 5.*

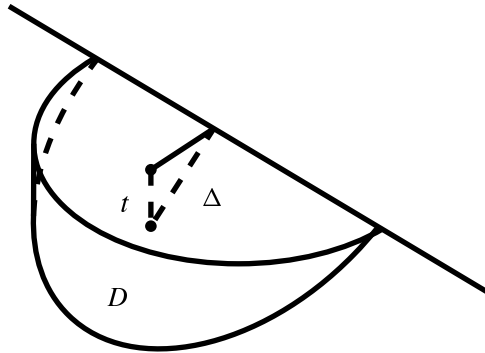

Fig. 6.4.

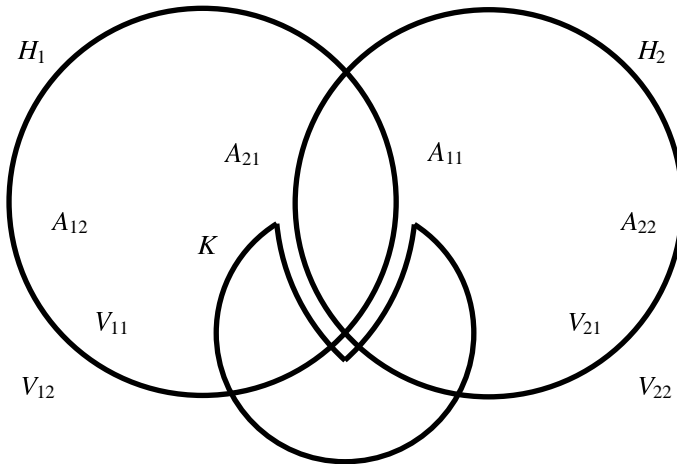

Fig. 6.5.

(3) *The conclusion of Lemma 6.3 holds.*

Proof. By Lemma C.2,  $A_{11}$  and  $A_{21}$  are  $K$ -parallel in  $(V_{11} \cap V_{21}, K \cap V_{11} \cap V_{21})$ . Suppose that one of  $A_{11}$  and  $A_{21}$ , say  $A_{11}$  is  $K$ -compressible in  $(V_{21}, t_{21})$ . Then  $H_2$  is weakly  $K$ -reducible by Lemma 6.2 since  $A_{12}$  does not have an essential  $K$ - $\partial$ -compressing disc by the assumption of this lemma. Hence we can assume that  $A_{11}$  and  $A_{21}$  are  $K$ -incompressible.

Suppose that one of  $A_{12}$  and  $A_{22}$ , say  $A_{12}$  has a  $K$ -compressing disc  $D$  in  $(V_{22}, t_{22})$ . If  $D$  is contained in  $V_{11} \cap V_{22}$ , then  $A_{21}$  is also  $K$ -compressible by Lemma C.1, which contradicts our assumption. Hence  $D$  is contained in  $V_{12} \cap V_{22}$ . By Lemma C.1,  $t = K \cap (V_{12} \cap V_{22})$  has a cancelling disc  $C'$  in  $V_{12} \cap V_{22}$  such that each of  $\partial C' \cap A_{12}$  and  $\partial C' \cap A_{22}$  is a single arc. We isotope  $K$  near  $t$  along  $C'$  slightly



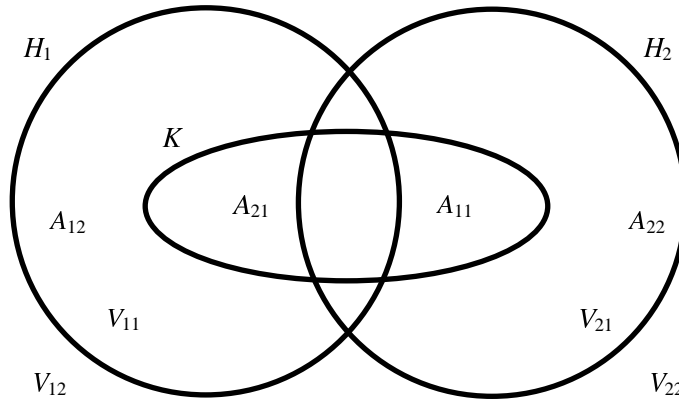

Fig. 7.1.

beyond the arc  $\partial C' - t$ . Then  $K$  is in the situation in the latter half of Section 5.

Hence we can assume that  $A_{12}$  and  $A_{22}$  are  $K$ -incompressible, and hence  $K$ - $\partial$ -compressible by Lemma 2.10. Suppose that  $V_{12} \cap V_{22}$  contains an inessential  $K$ - $\partial$ -compressing disc  $D$  of  $A_{12}$  and  $A_{22}$ . Then  $D$  cuts off a ball  $B$  from  $V_{12} \cap V_{22}$ , and we can take a cancelling disc  $C$  of the arc  $K \cap B$  so that  $\partial C \cap A_{i2}$  is an arc for  $i = 1$  and  $2$ . Then we isotope  $K$  along  $C$  to be in the situation of latter half of Section 5.

Hence we can suppose that  $V_{11} \cap V_{22}$  and  $V_{12} \cap V_{21}$  contain inessential  $K$ - $\partial$ -compressing discs of  $A_{12}$  and  $A_{22}$  respectively. This is the situation of Lemma 6.3.

□

**7. When  $H_1 \cap H_2$  consists of two essential loops (II)**

In this section, we will use Lemma D.1 in Appendix D. Let  $H_i, V_{ij}, A_{ij}, t_{ij}$  be as in Section 6. In this section, we consider case (II) where  $|A_{11} \cap K| = |A_{21} \cap K| = 2$  and  $A_{12} \cap K = A_{22} \cap K = \emptyset$ . See Fig. 7.1.

$K \cap (V_{11} \cap V_{21})$  consists of two arcs, say  $t_1$  and  $t_2$ , each of which connects  $A_{11}$  and  $A_{21}$ . By Lemma 2.10,  $A_{j1}$  is  $K$ -compressible or  $K$ - $\partial$ -compressible in  $(V_{i1}, t_{i1})$  for  $(i, j) = (1, 2)$  and  $(2, 1)$ .

Suppose that  $A_{j1}$  is  $K$ - $\partial$ -compressible in  $(V_{i1} \cap V_{j2}, t_{j2})$ . Any  $K$ - $\partial$ -compressing disc of  $A_{j1}$  intersects  $A_{i2}$  in an essential arc by the unusual definition of  $K$ - $\partial$ -compressibility, and hence it is also a  $K$ - $\partial$ -compressing disc of  $A_{i2}$ .  $K$ - $\partial$ -compressing a copy of  $A_{i2}$ , we obtain a  $K$ -compressing disc of  $A_{j1}$  in  $(V_{i1} \cap V_{j2}, t_{j2})$ .

Hence  $A_{j1}$  is  $K$ -compressible in  $(V_{i1}, t_{i1})$  or  $K$ - $\partial$ -compressible in  $(V_{11} \cap V_{21}, t_1 \cup t_2)$ . In the latter case, a  $K$ - $\partial$ -compressing disc of  $A_{j1}$  is also a  $K$ - $\partial$ -compressing disc of  $A_{i1}$  in  $(V_{11} \cap V_{21}, t_1 \cup t_2)$ . Thus it is sufficient to consider the following two cases.

- (1)  $A_{11}$  and  $A_{21}$  are  $K$ - $\partial$ -compressible in  $(V_{11} \cap V_{21}, t_1 \cup t_2)$ .
- (2)  $A_{11}$  and  $A_{21}$  are  $K$ - $\partial$ -incompressible in  $(V_{11} \cap V_{21}, t_1 \cup t_2)$ , and  $A_{j1}$  is

$K$ -compressible in  $(V_{i1}, t_{i1})$  for  $(i, j) = (1, 2)$  and  $(2, 1)$ .

**Lemma 7.1.** *In case (1), one of the three conditions (a)–(c) below holds.*

(a) *We can isotope  $H_1$  and  $H_2$  so that  $H_1$  and  $H_2$  intersect each other in a single inessential and  $K$ -essential loop. (We have already considered this situation in Section 5.)*

(b) *We can isotope  $H_1$  and  $H_2$  so that  $H_1 \cap H_2$  divide  $H_i$  into two annuli each of which intersects  $K$  in a single point for  $i = 1$  and  $2$ . (We have already considered this situation in Section 6.)*

(c) *One of  $H_1$  and  $H_2$  is weakly  $K$ -reducible.*

*Proof.* Let  $D$  be a  $K$ - $\partial$ -compressing disc of  $A_{11}$  and  $A_{21}$  in  $V_{11} \cap V_{21}$ . Then the arc  $\partial D \cap A_{i1}$  is either essential in both  $A_{11}$  and  $A_{21}$ , or inessential in them.

In the former case, we isotope  $H_1$  along  $D$ . Then  $H_1$  and  $H_2$  intersect each other in a single inessential and  $K$ -essential loop. This is the conclusion (a).

In the latter case, let  $D_i$  be the disc cut off from  $A_{i1}$  by the arc  $\partial D \cap A_{i1}$  for  $i = 1$  and  $2$ . Then  $|K \cap D_1| = |K \cap D_2|$ . This number of the intersection points is determined by the number of the arcs contained in the ball  $B$  bounded by the 2-sphere  $D \cup D_1 \cup D_2$  in  $V_{11} \cap V_{21}$ .

When  $|K \cap D_1| = |K \cap D_2| = 1$ ,  $K \cap B$  is a single trivial arc. Hence we can isotope  $H_1$  along  $B$  so that  $H_1$  and  $H_2$  are in position as in case (I). This is the conclusion (b).

When  $|K \cap D_1| = |K \cap D_2| = 2$ , we isotope  $H_1$  along  $D$ . Then  $H_1 \cap H_2$  is a union of a single inessential and  $K$ -essential loop and two essential loops on both  $H_1$  and  $H_2$ . We apply Lemma 10.1 in Section 10 to this situation. The conclusion (1) of Lemma 10.1 implies that we can isotope  $H_1$  and  $H_2$  so that they intersect each other in a single inessential and  $K$ -inessential loop. This is the conclusion (a) of this lemma. The conclusion (3) of Lemma 10.1 is the conclusion (c) of this lemma. The conclusion (2) of Lemma 10.1 implies that the discs  $D_1$  and  $D_2$  are  $K$ -parallel after the isotopy along  $D$ . Before the isotopy,  $B$  contains a  $K$ - $\partial$ -compressing disc of  $A_{11}$  and  $A_{21}$  as we considered in the previous paragraph. Hence we obtain the conclusion (b).  $\square$

In the rest of this section, we consider case (2) just before Lemma 7.1. Let  $D_j$  be a  $K$ -compressing disc of  $A_{j1}$  in  $(V_{i1}, t_{i1})$  for  $(i, j) = (1, 2)$  and  $(2, 1)$ . We say that  $D_j$  is *essential* if  $\partial D_j \cap A_{j1}$  is essential on  $A_{j1}$ , and otherwise it is *inessential*, following the definition in Appendix D.

We consider 4 cases below.

- (1) Both  $D_1$  and  $D_2$  are essential (Lemma 7.2).
- (2) One of  $D_1$  and  $D_2$  is essential, and the other is inessential (Lemma 7.4).
- (3) Both  $D_1$  and  $D_2$  are inessential. There are two subcases.

- (a)  $A_{11}$  or  $A_{21}$ , say  $A_{11}$  does not have a  $K$ - $\partial$ -compressing disc in  $(V_{12} \cap V_{21}, t_{12})$  (Lemma 7.5).
- (b)  $A_{j1}$  has a  $K$ - $\partial$ -compressing disc in  $(V_{j2} \cap V_{i1}, t_{j2})$  for  $(i, j) = (1, 2)$  and  $(2, 1)$  (right after Lemma 7.5).

**Lemma 7.2.** *If  $D_j$  is essential for  $j = 1$  and  $2$ , then one of  $H_1$  and  $H_2$  is  $K$ -reducible or weakly  $K$ -reducible.*

Proof. Suppose first that one of  $D_1$  and  $D_2$ , say  $D_1$  is not contained in  $V_{11} \cap V_{21}$ . Then  $D_1$  is contained in  $V_{12} \cap V_{21}$ . Similar argument as in the proof of Lemma A.1 (1) shows that  $D_2$  is not contained in  $V_{11} \cap V_{21}$ , and hence is contained in  $V_{11} \cap V_{22}$ . We perform a  $K$ -compressing operation on  $A_{11}$  along  $D_1$  and obtain a meridian disc  $D'_1$  of  $V_{21}$ . Since  $D_2$  is a meridian disc of  $V_{22}$ ,  $D_2$  and  $D'_1$  shows that  $M \cong S^2 \times S^1$ , which contradicts our assumption.

Secondly, we assume that both of  $D_1$  and  $D_2$  are contained in  $V_{11} \cap V_{21}$ .  $A_{12}$  is  $K$ -compressible or  $K$ - $\partial$ -compressible in  $(V_{22}, t_{22})$  by Lemma 2.10.

If  $A_{12}$  has a  $K$ -compressing disc, then  $K$ -compressing  $A_{12}$ , we obtain a meridian disc of  $V_{22}$ . Since  $D_2$  is a meridian disc of  $V_{21}$ ,  $M \cong S^2 \times S^1$ . This is again a contradiction.

Hence  $A_{12}$  has a  $K$ - $\partial$ -compressing disc  $D$  in  $(V_{22}, t_{22})$ . First, we consider the case where  $D$  is contained in  $V_{11} \cap V_{22}$ .  $K$ - $\partial$ -compressing  $A_{12}$  along  $D$ , we obtain a peripheral disc  $D'$  in  $V_{22}$ .  $D'$  is a  $K$ -compressing disc of  $A_{21}$ . We perform a  $K$ -compressing operation on  $A_{11}$  along  $D_1$ , to obtain a meridian disc  $Q$  of  $V_{21}$  such that  $Q$  intersects  $K$  in at most one point. Since  $\partial Q \subset \partial A_{11}$  is disjoint from  $\partial D'$ ,  $H_2$  is weakly  $K$ -reducible.

Secondly, we consider the case where  $D$  is contained in  $V_{12} \cap V_{22}$ .

Since  $V_{12} \cap V_{22}$  is disjoint from  $K$ ,  $V_{12} \cap V_{22}$  gives  $K$ -parallelism between  $A_{12}$  and  $A_{22}$ . Hence we can isotope  $H_1$  near  $A_{12}$  in  $(M, K)$  so that  $H_1$  is contained in  $V_{21}$  and that  $H_1$  is disjoint from the  $K$ -compressing disc  $D_2$  of  $A_{21}$ . Since  $D_2 \subset V_{11} \cap V_{21}$ ,  $\partial D_2$  is essential on  $A_{21}$ , and  $D_2$  is a meridian disc of  $V_{21}$ . Note that  $M = S^3$  because  $H_1$  is contained in the ball obtained by cutting  $V_{21}$  along  $D_2$ . Then we can apply Theorem 7.3 below, which is an extension of Lemma 4.5 in [31]. Hence  $H_2$  is weakly  $K$ -reducible. □

**Theorem 7.3** ([24]). *Let  $M$  be a closed orientable 3-manifold, and  $L$  a link in  $M$ . Assume that  $M$  has a double cover branched along  $L$ . Let  $H_i$  be a  $g_i$ -genus  $n_i$ -bridge splitting of  $(M, L)$  for  $i = 1$  and  $2$ , and  $W$  a handlebody of genus  $g$  bounded by  $H_2$  in  $M$ . Suppose that  $H_1$  is contained in  $\text{int } W$ , and that there is an  $L$ -compressing or meridionally compressing disc  $D$  of  $H_2$  in  $(W, L \cap W)$  with  $D \cap H_1 = \emptyset$ . Then either  $M = S^3$  and  $L$  is the trivial knot, or  $H_2$  is weakly  $L$ -reducible.*

**Lemma 7.4.** *Suppose that one of  $D_1$  and  $D_2$ , say  $D_1$  is essential, and that the other disc  $D_2$  is inessential. Then  $H_2$  is weakly  $K$ -reducible.*

Proof.  $K$ -compressing  $A_{11}$  along  $D_1$ , we obtain a meridian disc  $Q$  of  $V_{21}$  such that  $Q$  intersects  $K$  in at most one point.

Since  $\partial D_2$  is inessential in  $A_{21}$  and the arcs  $K \cap V_{11} \cap V_{21}$  connects  $A_{11}$  and  $A_{21}$ ,  $D_2$  is contained in  $(V_{22}, t_{22})$ . Hence  $H_2$  is weakly  $K$ -reducible because  $\partial Q \cap \partial D_2 = \emptyset$ .  $\square$

**Lemma 7.5.** *Suppose that  $D_1$  and  $D_2$  are inessential. If  $A_{11}$  or  $A_{21}$ , say  $A_{11}$  does not have a  $K$ - $\partial$ -compressing disc in  $(V_{12} \cap V_{21}, t_{12})$ , then  $H_2$  has a satellite diagram on  $A_{21}$ .*

Proof.  $D_1$  and  $D_2$  are inessential. Then, by Lemma D.1, there is a cancelling disc  $C_1$  of  $t_{21}$  in  $(V_{21}, t_{21})$  with  $\partial C_1 \cap H_2 \subset A_{21}$ . There is a cancelling disc  $C_2$  of  $t_{22}$  in  $(V_{22}, t_{22})$  with  $C_2 \cap D_2 = \emptyset$ . Note that  $\partial C_2 \cap H_2 \subset A_{21}$ . Then  $C_1$  and  $C_2$  together give a 1-bridge diagram on  $A_{21}$ .  $\square$

REMARK 7.6. Since  $A_{11}$  is  $K$ - $\partial$ -incompressible in  $(V_{12} \cap V_{21}, t_{12})$ , the loops  $H_1 \cap H_2$  are of non-longitudinal slopes of  $V_{21}$  and  $V_{12}$ . But they may be of longitudinal slopes of  $V_{22}$  and  $V_{11}$ .

Thus we can assume that  $A_{j1}$  has an inessential  $K$ -compressing disc  $D_j$  in  $(V_{i1}, t_{i1})$ , and that  $A_{j1}$  has a  $K$ - $\partial$ -compressing disc in  $(V_{j2} \cap V_{i1}, t_{j2})$  for  $(i, j) = (1, 2)$  and  $(2, 1)$ . Isotoping  $H_1$  and  $H_2$  near  $A_{11}$  and  $A_{21}$  along these  $K$ - $\partial$ -compressing discs, we obtain the conclusion (d) of Theorem 1.3.

## 8. When $H_1 \cap H_2$ consists of two inessential loops

In this section, we consider the case where  $H_1 \cap H_2$  consists of two loops which are inessential and  $K$ -essential on both  $H_1$  and  $H_2$ . For  $i = 1$  and  $2$ ,  $H_i$  contains two loops, say  $l_{i1}$  and  $l_{i2}$ , one of which, say  $l_{i1}$ , bounds a disc  $Q_i$  intersecting  $K$  in two points and disjoint from  $l_{i2}$ . Let  $R_i$  be the annulus cobounded by  $l_{i1}$  and  $l_{i2}$  on  $H_i$ , and  $H'_i$  the once punctured torus cut off by  $l_{i2}$  from  $H_i$  for  $i = 1$  and  $2$ . Note that  $R_i$  and  $H_i$  are disjoint from  $K$  for  $i = 1$  and  $2$ . Let  $V_{i1}$  be the solid torus bounded by  $H_i$  in  $M$  such that  $V_{i1}$  contains  $Q_j$  and  $H'_j$  for  $(i, j) = (1, 2)$  and  $(2, 1)$ . Let  $V_{i2}$  be the other solid torus bounded by  $H_i$  in  $M$  with  $R_j \subset V_{i2}$ . Set  $t_{ij} = K \cap V_{ij}$ .

If  $l_{11} = l_{22}$  and  $l_{12} = l_{21}$ , then  $H'_1 \cup R_1 \cup H'_2$  forms a closed surface of genus two which is disjoint from  $K$  and separates  $Q_1$  and  $Q_2$ . See Fig. 8.1, which is schematic. This contradicts that both  $Q_1$  and  $Q_2$  intersect  $K$  and  $K$  is a knot rather than a link. Hence  $l_{11} = l_{21}$  and  $l_{12} = l_{22}$ . See Fig. 8.2, which is also schematic. Let  $B$  be the ball component of  $V_{12} \cap V_{22}$  bounded by  $Q_1 \cup Q_2$ .

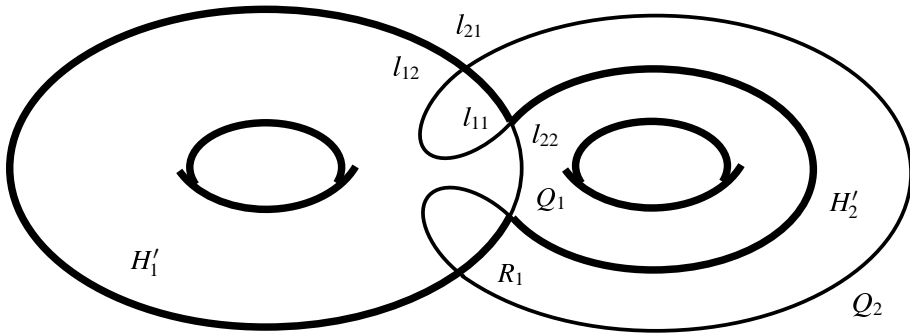

Fig. 8.1.

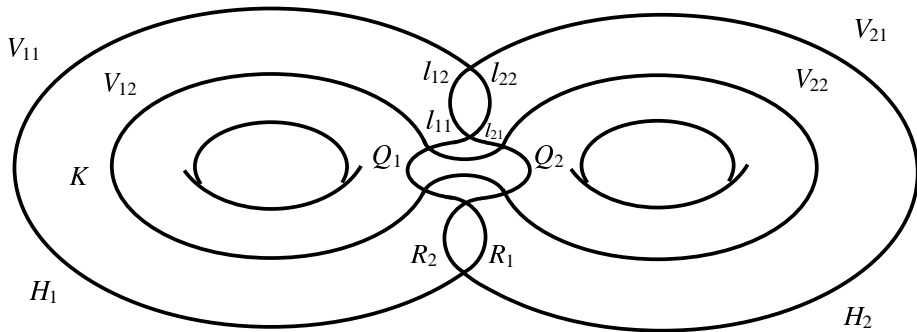

Fig. 8.2.

By Lemma 2.10,  $Q_i \cup H'_i$  is  $K$ -compressible or  $K$ - $\partial$ -compressible in  $(V_{j1}, t_{j1})$  for  $(i, j) = (1, 2)$  and  $(2, 1)$ . Hence one of the following four conditions (i)–(iv) holds.

- (i)  $H'_i$  has a  $K$ -compressing disc  $D$  in  $(V_{j1}, t_{j1})$  with  $D \cap Q_i = \emptyset$ .
- (ii)  $H'_i$  has a  $K$ - $\partial$ -compressing disc  $D$  in  $(V_{j1}, t_{j1})$  with  $D \cap Q_i = \emptyset$ .
- (iii)  $Q_i$  has a  $K$ -compressing disc  $D$  in  $(V_{j1}, t_{j1})$  with  $D \cap H'_i = \emptyset$ .
- (iv)  $Q_i$  has a  $K$ - $\partial$ -compressing disc  $D$  in  $(V_{j1}, t_{j1})$  with  $D \cap H'_i = \emptyset$ .

**Lemma 8.1.** *Suppose that the condition (iv) holds for  $(i, j) = (1, 2)$  or  $(2, 1)$ . Then  $Q_1$  and  $Q_2$  are  $K$ -parallel in  $(B, K \cap B)$ , and we can isotope  $Q_1$  along  $B$  slightly beyond  $Q_2$  to make  $H_1$  and  $H_2$  intersect in a single inessential and  $K$ -essential loop as in Section 5.*

*Proof.* Suppose, without loss of generality, that the condition (iv) holds for  $i = (1, 2)$ . Then there is a  $K$ - $\partial$ -compressing disc  $D$  of  $Q_1$  in  $(V_{21}, t_{21})$  with  $D \cap H'_1 = \emptyset$ . If the arc  $\partial D \cap H_2$  is contained in  $R_2$ , then it is an inessential arc in  $R_2$  because it has both endpoints in  $l_{21}$ . This contradicts the unusual definition of  $K$ - $\partial$ -compressing

disc. Hence the arc  $\partial D \cap H_2$  is contained in  $Q_2$ , and  $Q_1$  and  $Q_2$  are  $K$ -parallel in  $(B, K \cap B)$  by Lemma B.4.  $\square$

**Lemma 8.2.** *Suppose that the condition (ii) holds for  $i = 1$  or  $2$ . Then one of the two conditions below holds.*

- (1) *We can isotope  $H_1$  and  $H_2$  so that they intersect each other in a single loop which is inessential and  $K$ -essential on both  $H_1$  and  $H_2$  as in Section 5.*
- (2) *One of  $H_1$  and  $H_2$  is weakly  $K$ -reducible.*

*Proof.* Assume that (ii) holds for  $i = 1$ . By the unusual definition of  $K$ - $\partial$ -compressing disc, the arc  $\partial D \cap H_2$  is contained in  $H'_2$ . Hence  $D$  is also a  $K$ - $\partial$ -compressing disc of  $H'_2$  in  $(V_{11}, t_{11})$ . We isotope  $H_1$  along the  $K$ - $\partial$ -compressing disc  $D$ , and make  $H_1$  and  $H_2$  intersect in a single inessential loop and two essential loops both in  $H_1$  and  $H_2$ . We apply Lemma 10.1. The conclusion (1) of Lemma 10.1 implies that we can isotope one of the parallel annuli along the parallelism, and obtain the conclusion (1) of this lemma. The conclusion (2) of Lemma 10.1 implies that  $Q_1$  and  $Q_2$  are  $K$ -parallel before the isotopy along  $D$ . Then we can isotope  $Q_1$  along the parallelism slightly beyond  $Q_2$ , to cancel the intersection  $l_{11} = l_{21}$ . Hence we obtain the conclusion (1) of this lemma again. The conclusion (3) of Lemma 10.1 is the conclusion (2) of this lemma.  $\square$

**Lemma 8.3.** *Suppose that the condition (i) holds for  $(i, j) = (1, 2)$  or  $(2, 1)$ . Then  $Q_i$  has a  $K$ -compressing disc in  $(V_{j1}, t_{j1})$ , (which may intersect  $H'_i$ ).*

*Proof.* Suppose that the condition (i) holds for  $(i, j) = (1, 2)$ .  $K$ -compressing  $H'_1$  along  $D$ , we obtain a disc  $D'$  with  $D' \cap (K \cup Q_1) = \emptyset$  and  $\partial D' = \partial H'_1$ . Then the disc  $R_2 \cup D'$  forms a  $K$ -compressing disc of  $Q_1$ .  $\square$

By Lemmas 8.1, 8.2 and 8.3, we can assume that  $Q_i$  is  $K$ -compressible in  $(V_{j1}, t_{j1})$  for  $(i, j) = (1, 2)$  and  $(2, 1)$ .

**Lemma 8.4.** *Suppose that  $Q_i$  is  $K$ -compressible in  $(V_{j1}, t_{j1})$  for  $(i, j) = (1, 2)$  and  $(2, 1)$ . Then  $K$  is the trivial knot.*

*Proof.* Applying Lemma B.1 (2) to  $Q_1$  in  $(V_{21}, t_{21})$ , we obtain a cancelling disc  $C_1$  of  $t_{21}$  in  $V_{21}$  with  $\partial C_1 \cap H_2 \subset Q_2$ . Applying Lemma B.1 (3) to  $Q_2$  in  $(V_{11}, t_{11})$ , we obtain a cancelling disc  $C_2$  of  $t_{22}$  in  $\text{cl}(V_{11} - B)$  with  $\partial C_2 \cap H_2 \subset Q_2$ . Note that the interior of  $C_1$  and  $C_2$  may intersect each other in  $V_{11} \cap V_{21}$ . However, a standard innermost loop argument allows us to retake these discs so that their interiors are disjoint from each other. Then  $K$  has a 1-bridge diagram on the disc  $Q_2$ , and hence is trivial.  $\square$

**9. Two essential and inessential loops**

In this section, we consider the case where  $H_1 \cap H_2$  consists of two loops both of which are inessential in one of  $H_1$  and  $H_2$ , say  $H_1$ , and both essential in the other (ignoring the points  $K \cap H_1$  and  $K \cap H_2$ ). See Fig. 9.1.

Then a component of  $H_1 \cap H_2$ , say  $l_1$ , bounds a disc, say  $Q$ , in  $H_1$  with  $Q \cap H_2 = l_1$  and  $|K \cap Q| = 2$ . The other loop, say  $l_2$ , cobounds an annulus, say  $R$ , with  $l_1$  in  $H_1 - K$ . Let  $H'_1$  be the once punctured torus bounded by  $l_2$  in  $H_1 - K$ . Let  $V_{21}$  be the solid torus bounded by  $H_2$  in  $M$  with  $Q \cup H'_1 \subset V_{21}$ . The other solid torus bounded by  $H_2$  is denoted by  $V_{22}$ . Then  $R \subset V_{22}$ .  $l_1$  and  $l_2$  together divide  $H_2$  into two annuli, say  $A_1$  and  $A_2$ . Since  $R$  is separating in  $V_{22}$  and is disjoint from  $K$ , one of  $A_1$  and  $A_2$ , say  $A_1$  intersects  $K$  in two points, and the other disjoint from  $K$ . Let  $V_{11}$  be the solid torus bounded by  $H_1$  in  $M$  with  $A_1 \subset V_{11}$ . The other solid torus bounded by  $H_1$  is denoted by  $V_{12}$ . Then  $A_2 \subset V_{12}$ . Set  $t_{ij} = K \cap V_{ij}$  for  $i, j \in \{1, 2\}$ .

**Lemma 9.1.**  *$M = S^3$ ,  $l_1$  and  $l_2$  are longitudinal loops of  $V_{22}$  and  $R$  is  $K$ -parallel to  $A_2$  in  $(V_{22}, t_{22})$ .*

*Proof.* We ignore  $K$  in this paragraph. Since  $\partial Q$  is essential in  $H_2$ , it is of the meridional slope of  $V_{21}$ . Hence  $l_1$  and  $l_2$  are not of the meridional slope of  $V_{22}$ . Otherwise,  $M \cong S^2 \times S^1$ , which contradicts our assumption. Thus  $R$  is parallel to one of  $A_1$  and  $A_2$  in  $V_{22}$ . Hence we can isotope  $H_1$  into  $\text{int } V_{21}$  so that  $H_1$  is disjoint from a parallel copy of the meridian disc  $Q$  of  $V_{21}$ . Performing a  $K$ -compressing operation on  $H_2$  along  $Q$ , we obtain a 2-sphere  $S$  in  $V_{21}$ , where  $S$  bounds a ball which contains  $H_1$ . This sphere  $S$  bounds another ball on the other side in a solid torus bounded by  $H_1$ . Hence  $M = S^3$ .

Since before the isotopy,  $l_1$  and  $l_2$  are of the meridional slope of  $V_{21}$ , they are of a longitudinal slope of  $V_{22}$ . Then  $R$  is parallel to  $A_1$  and  $A_2$  in  $V_{22}$  ignoring  $t_{22}$ . Because  $V_{12} \cap V_{22}$  does not intersect  $K$ ,  $A_{12}$  is  $K$ -parallel to  $A_2$  in  $(V_{22}, t_{22})$ . □

By Lemma 2.10,  $Q \cup H'_1$  is  $K$ -compressible or  $K$ - $\partial$ -compressible in  $(V_{21}, t_{21})$ . Hence we have the four cases below.

- (1)  $Q$  has a  $K$ -compressing disc  $D$  in  $(V_{21}, t_{21})$  with  $D \cap H'_1 = \emptyset$ .
- (2)  $Q$  has a  $K$ - $\partial$ -compressing disc  $D$  in  $(V_{21}, t_{21})$  with  $D \cap H'_1 = \emptyset$ .
- (3)  $H'_1$  has a  $K$ -compressing disc  $D$  in  $(V_{21}, t_{21})$  with  $D \cap Q = \emptyset$ .
- (4)  $H'_1$  has a  $K$ - $\partial$ -compressing disc  $D$  in  $(V_{21}, t_{21})$  with  $D \cap Q = \emptyset$ .

**Lemma 9.2.** *Suppose that  $A_1$  has a  $K$ -compressing or a meridionally compressing disc  $P$  in  $(V_{11} \cap V_{21}, K \cap (V_{11} \cap V_{21}))$ . Then  $H_2$  is weakly  $K$ -reducible.*

*Proof.* Since  $R$  and  $A_2$  are  $K$ -parallel in  $(V_{22}, t_{22})$ , we can isotope  $H_1$  into  $\text{int } V_{21}$  so that  $H_1$  is disjoint from  $P$ . Since  $M \cong S^3$  by Lemma 9.1,  $M$  has a dou-

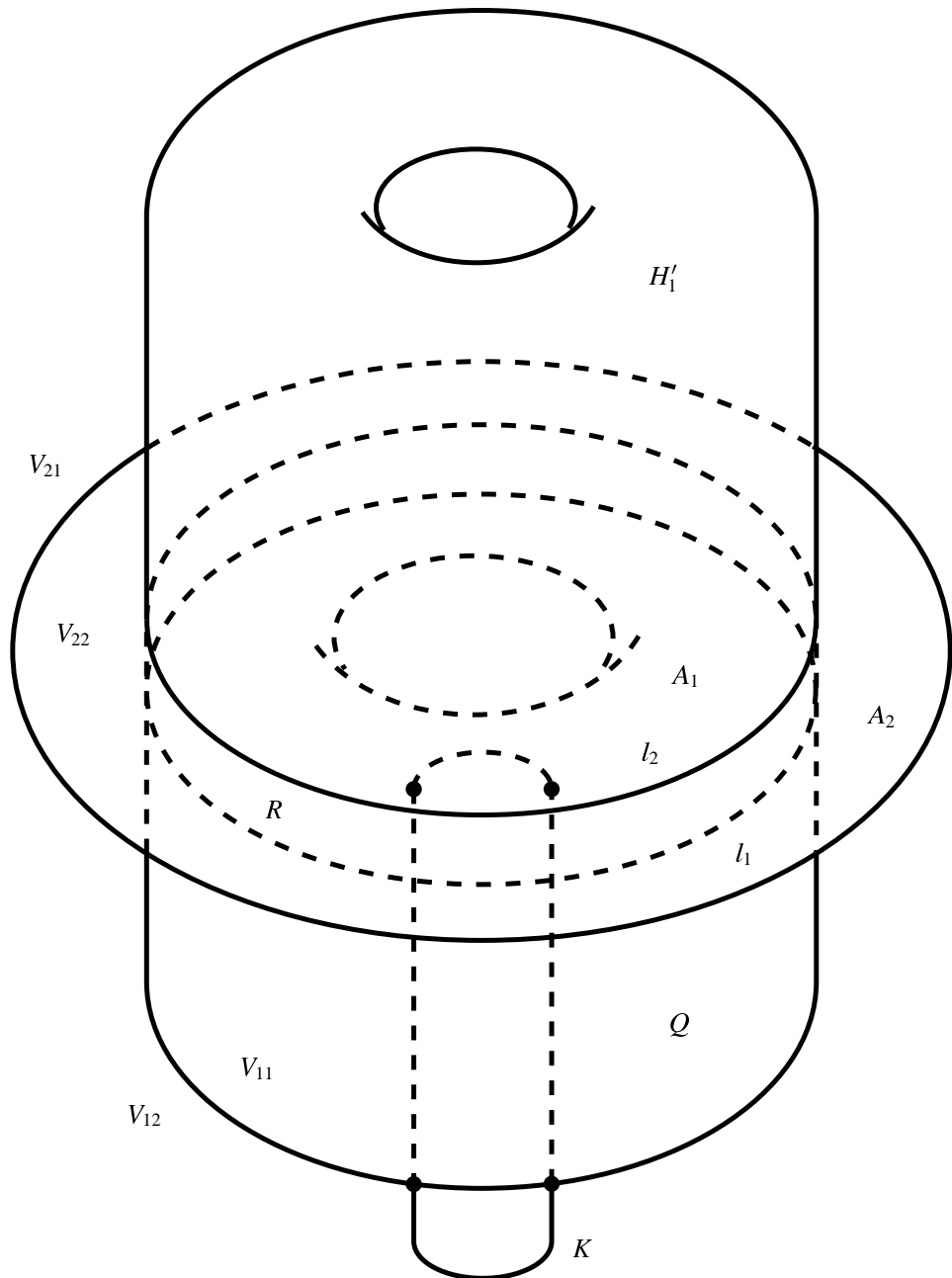

Fig. 9.1.



ble cover branched along  $K$ . Hence we can apply Theorem 7.3, to conclude that  $H_2$  is weakly  $K$ -reducible.  $\square$

**Lemma 9.3.** *In case (2)  $H_2$  is weakly  $K$ -reducible.*

Proof.  $Q$  has a  $K$ - $\partial$ -compressing disc  $D$  in  $(V_{21}, t_{21})$  with  $D \cap H'_1 = \emptyset$ . Since  $A_2$  is disjoint from  $K$ , the arc  $\partial D \cap H_2$  is contained in  $A_1$ , and  $D$  in  $V_{11} \cap V_{21}$ . The arc  $\partial D \cap Q$  divides  $Q$  into two discs, each of which intersects  $K$  in a single point, and one of which, say  $Q'$ , forms a meridian disc, say  $P$ , of  $V_{21}$  together with  $D$ .  $P$  is a meridionally compressing disc of  $A_1$ . Thus we conclude that  $H_2$  is weakly  $K$ -reducible by Lemma 9.2.  $\square$

**Lemma 9.4.** *In case (4)  $H_2$  is weakly  $K$ -reducible.*

Proof.  $H'_1$  has a  $K$ - $\partial$ -compressing disc  $D$  in  $(V_{21}, t_{21})$  with  $D \cap Q = \emptyset$ . The arc  $\partial D \cap H_2$  is essential in  $A_1 - K$ , and  $D$  is contained in  $V_{11} \cap V_{21}$ . Let  $O$  be the annulus obtained by  $K$ - $\partial$ -compressing a copy of  $H'_1$  along  $D$ . Note that  $O$  is contained in  $V_{11} \cap V_{21}$ . A component of  $\partial O$  is essential on  $H_2$ , and the other one is inessential and bounds a disc, say  $D'$ , on  $A_1$ .

Suppose first that  $D'$  intersects  $K$  in a single point. Then the disc  $O \cup D'$  gives a meridionally compressing disc of  $A_1$ . Hence  $H_2$  is weakly  $K$ -reducible by Lemma 9.2.

Secondly, we suppose that  $D'$  intersects  $K$  in two points. We isotope  $H_1$  in  $(M, K)$  along  $D$  slightly beyond the arc  $\partial D \cap H_2$ . Then  $H_1$  and  $H_2$  intersect each other in three  $K$ -essential loops, and  $H_1 \cap H_2$  contains a loop which is essential on  $H_i$  and inessential on  $H_j$  for  $(i, j) = (1, 2)$  and  $(2, 1)$ . Then by Lemma 10.3,  $H_1$  and  $H_2$  are weakly  $K$ -reducible.  $\square$

**Lemma 9.5.** *In case (1)  $H_2$  is weakly  $K$ -reducible.*

Proof. In case (1), by  $K$ -compressing  $Q$ , we obtain a meridian disc  $Q'$  of  $V_{21}$  with  $K \cap Q' = \emptyset$ .  $A_1$  is  $K$ -compressible or  $K$ - $\partial$ -compressible in  $(V_{11}, t_{11})$  by Lemma 2.10.

Suppose that  $A_1$  has a  $K$ -compressing disc. If it is contained in  $V_{11} \cap V_{22}$ , then, together with  $Q'$ , it shows that  $H_2$  is weakly  $K$ -reducible. If it is in  $V_{11} \cap V_{21}$ , then  $H_2$  is weakly  $K$ -reducible by Lemma 9.2.

Hence we can assume that  $A_1$  has a  $K$ - $\partial$ -compressing disc, say  $D_1$ , in  $(V_{11}, t_{11})$ . If  $D_1$  is contained in  $V_{21}$ , then it is also a  $K$ - $\partial$ -compressing disc of  $Q$  or  $H'_1$ . Hence, by Lemmas 9.3 and 9.4,  $H_2$  is weakly  $K$ -reducible. Thus  $D_1$  is contained in  $V_{11} \cap V_{22}$ , and it is also a  $K$ - $\partial$ -compressing disc of  $R$ . By performing a  $K$ - $\partial$ -compressing operation on a copy of  $R$ , we obtain a peripheral  $K$ -compressing disc of  $A_2$ . This disc and  $Q'$  show that  $H_2$  is  $K$ -reducible.  $\square$

**Lemma 9.6.** *In case (3)  $H_2$  is weakly  $K$ -reducible.*

*Proof.*  $K$ -compressing  $H'_1$ , we obtain a meridian disc  $E$  of  $V_{21}$  with  $E \cap K = \emptyset$ . If the  $K$ -compressing disc  $D$  is contained in  $V_{11} \cap V_{21}$ , then  $E$  is also in  $V_{11} \cap V_{21}$ , and  $H_2$  is weakly  $K$ -reducible by Lemma 9.2. If  $E$  is contained in  $V_{12} \cap V_{21}$ , then the disc  $E' = E \cup A_2$  forms a  $K$ -compressing disc of  $Q$  in  $(V_{21}, t_{21})$ , and  $H_2$  is weakly  $K$ -reducible by Lemma 9.5.  $\square$

### 10. When $|H_1 \cap H_2| = 3$

We consider the case where  $|H_1 \cap H_2| = 3$  in this section. By Proposition 4.1, we can assume that  $H_i - K$  does not contain three parallel loops of  $H_1 \cap H_2$ . Then  $H_i$  contains two essential loops and a single inessential loop of  $H_1 \cap H_2$  for  $i = 1$  and  $2$ . Let  $Q_i$  be the disc bounded by the inessential intersection loop on  $H_i$ . Note that  $Q_i$  intersects  $K$  transversely in two points for  $i = 1$  and  $2$ . Let  $A_i$  be the annulus cut off from  $H_i$  by the two essential intersection loops such that  $A_i \cap Q_i = \emptyset$  for  $i = 1$  and  $2$ . Set  $H'_i = \text{cl}(H_i - (A_i \cup Q_i))$ , the 2-sphere with three holes, for  $i = 1$  and  $2$ . Let  $V_{i1}$  be the solid torus bounded by  $H_i$  in  $M$  with  $Q_j \cup A_j \subset V_{i1}$  for  $(i, j) = (1, 2)$  and  $(2, 1)$ . The other solid torus bounded by  $H_i$  is denoted by  $V_{i2}$ . Set  $t_{ij} = K \cap V_{ij}$  for  $i, j \in \{1, 2\}$ .

**Lemma 10.1.** *Suppose that among the components of  $H_1 \cap H_2$  essential loops on  $H_1$  are essential also on  $H_2$ , and the inessential loop on  $H_1$  is inessential also on  $H_2$ . See Fig. 10.1, which is schematic. Then one of the three conditions below holds.*

- (1)  $A_1$  and  $A_2$  are  $K$ -parallel, and the interior of the parallelism intersect neither  $H_1$  nor  $H_2$ .
- (2)  $Q_1$  and  $Q_2$  are  $K$ -parallel, and the interior of the parallelism intersect neither  $H_1$  nor  $H_2$ .
- (3) One of  $H_1$  and  $H_2$  is weakly  $K$ -reducible.

*In cases (1) and (2), we can isotope  $H_1$  and  $H_2$  in  $(M, K)$  so that  $H_1$  and  $H_2$  intersect in smaller number of non-empty collection of loops which are  $K$ -essential on both  $H_1$  and  $H_2$ .*

*Proof.*

**CLAIM 10.2.** For each pair of  $(i, j) = (1, 2)$  and  $(2, 1)$ , one of the three conditions below holds.

- (i) The conclusion (1) or (2) of the lemma holds.
- (ii)  $Q_j$  has a  $K$ -compressing disc in  $(V_{i1}, t_{i1})$ . (The compressing disc may intersect  $A_j$ .)
- (iii) There is a meridian disc, say  $R_j$ , of  $V_{i1}$  with  $\partial R_j \subset H'_i$ ,  $R_j \cap (Q_j \cup A_j) = \emptyset$  and  $|K \cap R_j| = 1$ .

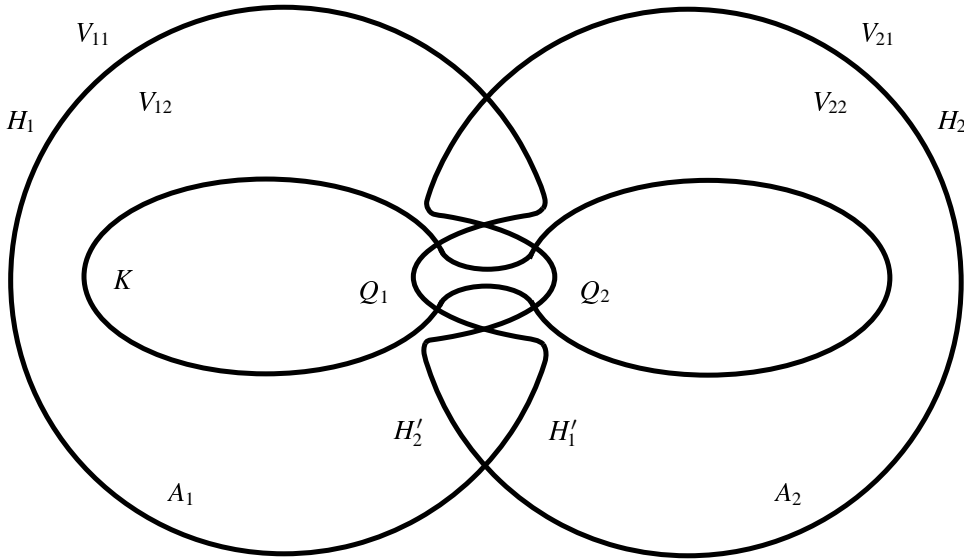

Fig. 10.1.

Proof. By Lemma 2.10,  $Q_j \cup A_j$  is  $K$ -compressible or  $K$ - $\partial$ -compressible in  $(V_{i1}, t_{i1})$ .

Suppose first that  $Q_j \cup A_j$  has a  $K$ - $\partial$ -compressing disc  $D$ . We assume first that  $D$  is incident to  $A_j$ . When  $\partial D \subset A_1 \cup A_2$ ,  $A_1$  and  $A_2$  are  $K$ -parallel. This is the conclusion (1) of this lemma. Hence we can assume that  $\partial D \subset A_j \cup H'_i$ .  $K$ - $\partial$ -compressing a copy of  $A_j$ , we obtain a peripheral disc, say  $D'$ , in  $V_{i1}$  such that  $\partial D'$  and  $\partial Q_j$  cobounds an annulus on  $H'_i$ . The union of  $D'$  and this annulus forms a  $K$ -compressing disc of  $Q_j$ . This is the conclusion (ii). Hence we can assume that  $D$  is incident to  $Q_i$ . When  $\partial D \subset Q_1 \cup Q_2$ ,  $Q_1$  and  $Q_2$  are  $K$ -parallel by Lemma B.4. This is the conclusion (2) of this lemma. When  $\partial D \subset Q_j \cup H'_i$ , by  $K$ - $\partial$ -compressing a copy of  $Q_j$ , we obtain two meridian discs intersecting  $K$  in a single point. After an adequate small isotopy, this meridian discs are disjoint from  $Q_j$  and  $A_j$ . This is the conclusion (iii).

Suppose that  $Q_j \cup A_j$  has a  $K$ -compressing disc  $P$ . If  $P$  is incident to  $Q_j$ , then we are done. If  $P$  is incident to  $A_j$ , then, by  $K$ -compressing a copy of  $A_j$ , we obtain two meridian discs disjoint from  $K$  in  $V_{i1}$ . By  $K$ -compressing a copy of  $H'_i \cup A_i$  along such a meridian disc, we obtain a  $K$ -compressing disc of  $Q_j$  in  $(V_{i1}, t_{i1})$ . This is the conclusion (ii). Thus Claim has proven. □

In case (ii), performing a  $K$ -compressing operation on a copy of  $Q_j$ , we obtain a peripheral disc  $S_j$  disjoint from  $K$  such that  $\partial S_j = \partial Q_j$ . Note that the disc  $S_j$  may intersect the annulus  $A_j$ . In case (iii),  $\partial R_j$  is parallel to a component of  $\partial A_i = \partial A_j$  on  $H'_i$ , and the loops  $\partial A_j$  are of meridional slope of the solid tori  $V_{i1}$  and  $V_{j2}$ .

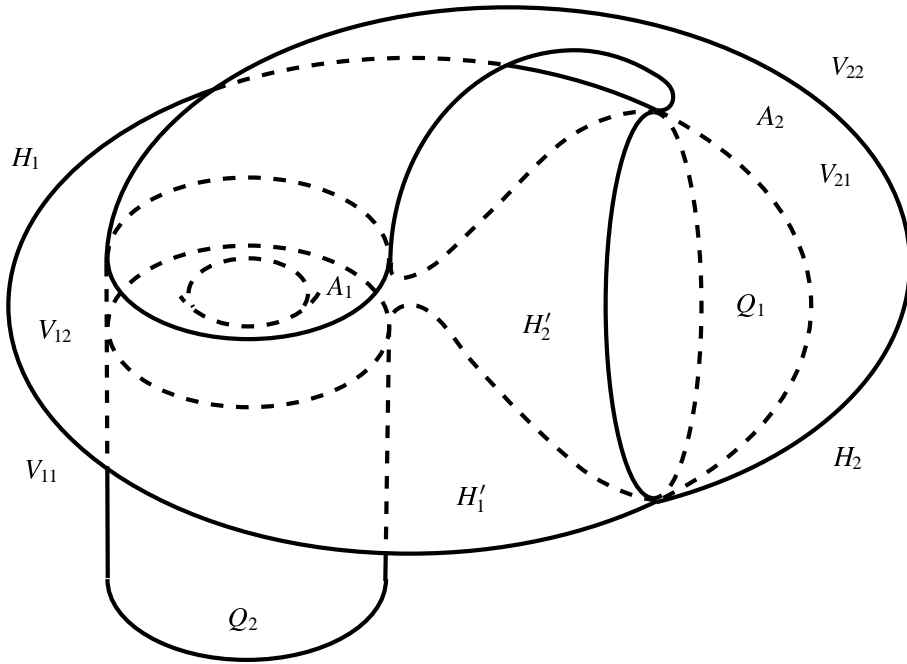

Fig. 10.2.

If (iii) holds for  $(i, j) = (1, 2)$  and  $(2, 1)$ , then  $M \cong S^2 \times S^1$ , which contradicts our assumption. If (ii) holds, say for  $(i, j) = (1, 2)$ , and (iii) holds for  $(i, j) = (2, 1)$ , then  $S_2$  and  $R_2$  show that  $H_1$  is weakly  $K$ -reducible.

Suppose that (ii) holds for  $(i, j) = (1, 2)$  and  $(2, 1)$ . Since  $Q_1$  is  $K$ -compressible in  $(V_{21}, t_{21})$ , Lemma B.1 (2) implies that  $t_{21}$  has a cancelling disc  $C_1$  in  $V_{21}$  with  $\partial C_1 \cap H_2 \subset Q_2$ . Let  $B$  be the ball bounded by  $Q_1 \cup Q_2$  in  $V_{11}$ . Since  $Q_2$  is  $K$ -compressible in  $(V_{11}, t_{11})$ , Lemma B.1 (3) implies that  $t_{22}$  has a cancelling disc  $C_2$  in  $V'_{11} = \text{cl}(V_{11} - B)$  with  $\partial C_1 \cap \partial V'_{11} \subset Q_2$ .  $C_1$  and  $C_2$  may intersect each other in loops in their interior. A standard innermost loop argument allows us to retake  $C_1$  and  $C_2$  so that their interiors are disjoint from each other and so that they give a 1-bridge diagram of  $K$  on  $Q_2$ . Hence  $K$  is the trivial knot, and Theorem B in [13] implies that  $H_2$  is weakly  $K$ -reducible.  $\square$

**Lemma 10.3.** *Suppose that the inessential loop of  $H_1 \cap H_2$  on  $H_i$  is essential on  $H_j$  for  $(i, j) = (1, 2)$  and  $(2, 1)$ . See Fig. 10.2. Then  $H_i$  is  $K$ -reducible for  $i = 1$  and 2.*

Proof.

CLAIM 10.4. For  $(i, j) = (1, 2)$  and  $(2, 1)$ ,  $Q_j$  has a  $K$ -compressing disc  $D_j$  with  $D_j \cap A_j = \emptyset$  in  $(V_{i1}, t_{i1})$ .

Proof. Note that  $Q_j$  is a meridian disc of  $V_{i1}$  and that a component of  $\partial A_j$ , say  $l_1$  is essential on  $H_i$  and the other, say  $l_2$  is inessential on  $H_i$ . By Lemma A.2, there is a  $K$ -compressing disc  $D$  of  $A_j$  bounded by  $l_1$ . We take  $D$  so that  $D \cap Q_j$  consists of minimal number of loops. Then a standard innermost loop argument shows that the intersection loops are essential on  $Q_j - K$ . If  $D$  is disjoint from  $Q_j$ , then the disc  $D \cup A_i$  forms a  $K$ -compressing disc of  $Q_j$ . If  $D$  does intersect  $Q_j$ , then an innermost loop on  $D$  bounds a  $K$ -compressing disc of  $Q_j$  as desired. Thus Claim has proven.  $\square$

For  $(i, j) = (1, 2)$  and  $(2, 1)$ , the  $K$ -compressing disc  $D_j$  of  $Q_j$  is contained in  $V_{i1} \cap V_{j2}$  since  $V_{11} \cap V_{21}$  contains two subarcs of  $K$  connecting  $Q_1$  and  $Q_2$ . By  $K$ -compressing  $Q_j$  along  $D_j$ , we obtain a meridian disc  $P_j$  of  $V_{i1}$  with  $P_j \cap K = \emptyset$ . Since  $D_i$  is a  $K$ -compressing disc of  $H_i$  in  $V_{i2}$ , and since  $\partial D_i$  and  $\partial P_j$  are disjoint,  $H_i$  is  $K$ -reducible.  $\square$

**11. When  $|H_1 \cap H_2| = 4$**

We consider in this section the case where  $|H_1 \cap H_2| = 4$ . By Proposition 4.1 we can assume for  $i = 1$  and  $2$  that  $H_i$  does not contain 3 loops of  $H_1 \cap H_2$  which are parallel in  $H_i - K$ . Then for each of  $i = 1$  and  $2$ , either

- (I)  $H_i$  contains two essential intersection loops parallel in  $H_i - K$  and two inessential intersection loops parallel in  $H_i - K$ , or
- (II)  $H_i$  contains two families of two parallel essential intersection loops in  $H_i - K$ .

In case (I) the two points  $K \cap H_i$  are contained in the disc component of  $H_i - H_j$ , and in case (II) the two points  $K \cap H_i$  are contained in distinct and non-adjacent annulus components of  $H_i - H_j$ . In both cases, for  $(i, j) = (1, 2)$  and  $(2, 1)$ ,  $H_i - H_j$  has two annulus components, say  $A_{i1}$  and  $A_{i2}$ , disjoint from  $K$ . They are contained in the same solid torus, say  $V_{j1}$ , bounded by  $H_j$  in  $M$ . Let  $V_{j2}$  be the other solid torus bounded by  $H_j$  in  $M$ , and set  $t_{jk} = K \cap V_{jk}$  for  $j, k \in \{1, 2\}$ .

**Lemma 11.1.** *For  $(i, j) = (1, 2)$  and  $(2, 1)$ , one of the two conditions below holds.*

- (1)  $A_{ik}$  is  $K$ -parallel to an annulus on  $H_j$  in  $(V_{j1}, t_{j1})$  for  $k = 1$  or  $k = 2$ .
- (2) There is a cancelling disc  $C_1$  of  $t_{j1}$  in  $(V_{j1}, t_{j1})$  with  $(\partial C_1 \cap H_j) \cap (H_1 \cap H_2) = \emptyset$ . (int  $C_1$  may intersect  $H_i$ .)

*Moreover, if the essential loops of  $H_1 \cap H_2$  are of a longitudinal slope of  $V_{j1}$ , then the conclusion (1) holds.*

Proof. By using Lemma 2.10 repeatedly, performing  $K$ -compressing and  $K$ - $\partial$ -compressing operations on  $A_{i1} \cup A_{i2}$ , we can obtain discs.

Suppose that there are peripheral discs. Let  $Q_1$  be the outermost one cutting off a ball  $B_1$  from  $V_{j1}$  such that  $B_1$  is disjoint from the other discs. If  $B_1$  is disjoint

from  $K$ , then  $Q_1$  is yielded by a  $K$ - $\partial$ -compressing operation since  $H_1 \cap H_2$  does not contain a  $K$ -inessential loop. Thus we obtain the conclusion (1). If  $B_1$  contains  $t_{j1}$ , then the conclusion (2) holds. Note that the interior of the disc  $B_1 \cap H_j$  is disjoint from  $H_1 \cap H_2$  because  $Q_1$  is outermost.

Suppose that there are no peripheral discs. Then the argument as in the proof of Lemma A.2 allows us to assume that the operations are all  $K$ -compressing ones, and that we obtain four meridian discs which are bounded by  $H_1 \cap H_2$ , and together divide  $V_{j1}$  into four balls. One of the balls contain  $t_{j1}$ , and the conclusion (2) holds.

If the essential loops of  $\partial(A_{i1} \cup A_{i2})$  are of a longitudinal slope of  $V_{j1}$ , then Lemma A.1 implies that the conclusion (1) holds.  $\square$

**Lemma 11.2.** *Suppose that, for  $(i, j) = (1, 2)$  or  $(2, 1)$ ,  $H_i \cap V_{j2}$  contains a peripheral disc  $Q_i$  which intersects  $K$  in two points. Then one of the three conditions below holds.*

- (1)  $A_{ik}$  is  $K$ -parallel to an annulus on  $H_j$  in  $(V_{j1}, t_{j1})$  for  $k = 1$  or  $2$ .
- (2)  $Q_i$  is  $K$ -parallel to a disc in  $H_j$ .
- (3)  $H_j$  is weakly  $K$ -reducible.

In cases (1) and (2), Lemma 4.2 allows us to isotope  $H_1$  and  $H_2$  in  $(M, K)$  so that  $H_1$  and  $H_2$  intersect each other in smaller number of non-empty collection of loops which are  $K$ -essential on both  $H_1$  and  $H_2$ .

*Proof.* The conclusion (1) of Lemma 11.1 is the conclusion (1) of this lemma. Hence we can assume that there is a cancelling disc  $C_1$  of  $t_{j1}$  with  $(\partial C_1 \cap H_j) \cap (H_1 \cap H_2) = \emptyset$  as in (2) of Lemma 11.1.

By Lemma 2.10,  $Q_i$  is  $K$ -compressible or  $K$ - $\partial$ -compressible in  $(V_{j1}, t_{j1})$ . Suppose first that  $Q_i$  is  $K$ -compressible. By  $K$ -compressing  $Q_i$ , we obtain a  $K$ -compressing disc  $D_i$  of  $H_j$  with  $D_i \cap K = \emptyset$ . Then  $D_i$  and  $C_1$  are disjoint, and show that  $H_j$  is  $K$ -reducible.

Suppose that  $Q_i$  has a  $K$ - $\partial$ -compressing disc, say  $D$ , in  $(V_{j2}, t_{j2})$ . Since  $Q_i$  is peripheral,  $\partial Q_i$  bounds a disc  $Q_j$  on  $H_j$ . If the arc  $\partial D \cap H_j$  is contained in  $Q_j$ , then we obtain the conclusion (2) by Lemma B.4. Hence we can assume that the arc  $\partial D \cap H_j$  is disjoint from  $\text{int } Q_j$ . The arc  $\partial D \cap Q_i$  divides  $Q_i$  into two discs, and let  $R_i$  be one of them.  $R_i$  intersects  $K$  in a single point, and  $R'_i = R_i \cup D$  forms a meridian disc of  $V_{j2}$  by the unusual definition of  $K$ - $\partial$ -compressibility. After an adequate small isotopy,  $R'_i$  is disjoint from  $Q_i$ . Since the two points  $K \cap H_j$  is contained in  $Q_j$ ,  $\partial C_1 \cap H_j \subset \text{int } Q_j$  and  $\partial R'_i \cap \partial C_1 = \emptyset$ . Hence  $H_j$  is weakly  $K$ -reducible.  $\square$

**Lemma 11.3.** *Suppose that, for  $(i, j) = (1, 2)$  or  $(2, 1)$ , a component of  $H_i \cap V_{j2}$  forms a meridian disc  $Q_i$  of  $V_{j2}$  such that  $Q_i$  intersects  $K$  in two points. Then one of the two conditions below holds.*

- (1) We can isotope  $H_1$  and  $H_2$  in  $(M, K)$  so that  $H_1$  and  $H_2$  intersect each other in

smaller number of non-empty collection of loops which are  $K$ -essential on both  $H_1$  and  $H_2$ .

(2)  $H_j$  is weakly  $K$ -reducible.

Proof. The conclusion (1) of Lemma 11.1 implies the conclusion (1) of this lemma by Lemma 4.2. Hence we can assume that there is a cancelling disc  $C_1$  of  $t_{j1}$  with  $(\partial C_1 \cap H_j) \cap (H_1 \cap H_2) = \emptyset$  as in (2) of Lemma 11.1.

$H_i$  intersects  $V_{j2}$  in a disjoint union of  $Q_i$  and a 2-sphere with three holes, say  $P$ . By Lemma 2.10,  $Q_i \cup P$  is  $K$ -compressible or  $K$ - $\partial$ -compressible in  $(V_{j2}, t_{j2})$ . Suppose first that  $Q_i \cup P$  has a  $K$ -compressing disc  $D$ . Then  $K$ -compressing  $Q_i \cup P$ , we obtain a disc component  $D'$  disjoint from  $K$  and bounded by a component of  $H_1 \cap H_2$ . Since  $\partial D' \cap C_1 = \emptyset$ ,  $H_j$  is  $K$ -reducible. Note that similar argument shows  $H_j$  is weakly  $K$ -reducible when  $P$  is meridionally  $K$ -compressible in  $(V_{j2}, t_{j2})$ .

Suppose that  $Q_i \cup P$  has a  $K$ - $\partial$ -compressing disc  $D$ . If  $D$  is incident to  $Q_i$ , then performing a  $K$ - $\partial$ -compressing operation on a copy of  $Q_i$ , we obtain a meridian disc  $D_1$  and a peripheral disc  $D_2$  such that each of them intersects  $K$  in a single point. Let  $D'_2$  be the disc bounded by  $\partial D_2$  on  $H_j$ . Then we can see that  $D'_2$  also intersects  $K$  in a single point, considering the 2-sphere  $D_2 \cup D'_2$ . If  $H_1 \cap H_2$  contains an inessential loop on  $H_j$ , then such a loop bounds a disc intersecting  $K$  in two points, and hence must intersect the arc  $\partial D \cap H_j$ , which is a contradiction. Hence no loop of  $H_1 \cap H_2$  is inessential on  $H_j$ , and  $\partial D_1$  and a loop, say  $l$ , of  $H_1 \cap H_2$  cobound an annulus, say  $R$ , disjoint from  $K$  on  $H_j$ . (Recall that  $H_j - K$  does not contain three parallel loops of  $H_1 \cap H_2$ .) After an adequate small isotopy, the disc  $R' = R \cup D_1$  gives a meridian disc of  $V_{j2}$  with  $|R' \cap K| = 1$  and  $\partial R' = l$ . Since  $\partial R' \cap \partial C_1 = \emptyset$ ,  $H_j$  is weakly  $K$ -reducible.

Hence we can assume that  $D$  is incident to  $P$ . Suppose that a  $K$ - $\partial$ -compressing operation on a copy of  $P$  along  $D$  yields a  $K$ -inessential boundary loop. Then this loop bounds a disc intersecting  $K$  in at most one point on  $H_j$ , and we isotope this disc near its boundary along the copies of  $D$ , to obtain a  $K$ -compressing disc or meridionally compressing disc of  $P$  in  $(V_{j2}, t_{j2})$ . Hence we obtain the conclusion (2) by a similar argument in the second paragraph.

Hence we can assume that we can isotope  $H_i$  in  $(M, K)$  along  $D$  slightly beyond the arc  $\partial D \cap H_j$ , so that  $H_1$  and  $H_2$  intersect each other in  $K$ -essential loops after the isotopy. When the arc  $\partial D \cap H_j$  connects distinct components of  $\partial P$ , this isotopy decreases the number of intersection loops, and we obtain the conclusion (1). When the arc  $\partial D \cap H_j$  has both endpoints in the same component of  $\partial P$ , this isotopy increases the number of intersection loops by one. Note that  $H_1 \cap H_2$  has three parallel loops on  $H_j$ . We apply Proposition 4.1. The conclusion (1) of Proposition 4.1 implies that we can further isotope  $H_1$  and  $H_2$  so that  $H_1$  and  $H_2$  intersects each other in non-empty collection of three or less number of loops which are  $K$ -essential both on  $H_1$  and  $H_2$ . The conclusion (2) of Proposition 4.1 is the conclusion (2) of this lemma. The conclusion (3) of Proposition 4.1 is impossible, since  $H_1 \cap H_2$  contains  $\partial Q_i$  of the meridional

slope of  $V_{j_2}$ . □

**Lemma 11.4.** *Suppose that, for  $(i, j) = (1, 2)$  and  $(2, 1)$ ,  $H_i \cap V_{j_2}$  consists of two annuli, say  $R_{i1}$  and  $R_{i2}$ , such that each of them intersects  $K$  in a single point. Then one of the four conditions below holds.*

- (1)  $A_{ik}$  is  $K$ -parallel to an annulus on  $H_j$  in  $(V_{j_1}, t_{j_1})$  for  $k = 1$  or  $2$ .
- (2) One of  $R_{i1}$  and  $R_{i2}$  is  $K$ -parallel to an annulus on  $H_j$  in  $(V_{j_2}, t_{j_2})$ .
- (3) One of  $H_1$  and  $H_2$  is  $K$ -reducible.
- (4) One of  $H_1$  and  $H_2$  has a satellite diagram of non-meridional and non-longitudinal slope given by a loop of  $H_1 \cap H_2$ .

In cases (1) and (2), Lemma 4.2 allows us to isotope  $H_1$  and  $H_2$  in  $(M, K)$  so that  $H_1$  and  $H_2$  intersect each other in smaller number of non-empty collection of loops which are  $K$ -essential on both  $H_1$  and  $H_2$ .

*Proof.* Note that the loops  $H_1 \cap H_2$  are essential both on  $H_1$  and  $H_2$ .

The conclusion (1) of Lemma 11.1 is the conclusion (1) of this lemma. Hence we can assume that there is a cancelling disc  $C_1$  of  $t_{j_1}$  with  $(\partial C_1 \cap H_j) \cap (H_1 \cap H_2) = \emptyset$  as in (2) of Lemma 11.1.

By Lemma 2.10,  $R_{i1} \cup R_{i2}$  is  $K$ -compressible or  $K$ - $\partial$ -compressible. Suppose first that it is  $K$ -compressible. The  $K$ -compression yields a meridian disc disjoint from  $K$  and  $C_1$ . Then  $H_j$  is  $K$ -reducible.

Suppose that  $R_{i1} \cup R_{i2}$  is  $K$ -incompressible, and has a  $K$ - $\partial$ -compressing disc, say  $D$ , in  $(V_{j_2}, t_{j_2})$ . We can assume, without loss of generality, that  $D$  is incident to  $R_{i1}$ . If the arc  $\partial D \cap R_{i1}$  is essential on  $R_{i1}$ , then we obtain the conclusion (2) by Lemma C.2. Hence we can assume that the arc  $\partial D \cap R_{i1}$  is inessential on  $R_{i1}$ . Then by Lemma C.3 either the conclusion (2) holds, or there is a cancelling disc  $C_2$  of  $t_{j_2}$  in  $(V_{j_2}, t_{j_2})$  such that  $\partial C_2 \cap H_j$  is disjoint from a component of  $\partial R_{i1}$ . Hence  $C_1$  and  $C_2$  together show that  $H_j$  has a satellite diagram. If the slope of the satellite diagram is meridional, then  $K$  is the trivial knot. If the slope of the satellite diagram is longitudinal, then one of the conclusions (1) and (2) of this lemma holds by Lemmas A.1 and C.3. □

## 12. Semi-satellite diagrams

In this section, we will show that the conclusion of Lemma 6.3 implies that either  $H_i$  admits a satellite diagram or  $K$  is a torus knot.

**Lemma 12.1.** *Let  $M, K, H_i, V_{ik}, t_{ik}, A_{jk}$  as in Section 6. Suppose that the loops  $H_1 \cap H_2$  are non-meridional and non-longitudinal with respect to  $V_{ik}$  for  $i, k \in \{1, 2\}$ . For  $(i, j) = (1, 2)$  and  $(2, 1)$ , if  $A_{j1}$  and  $A_{j2}$  are of the form as in the conclusion Lemma C.3 (2) in Appendix C, then either*

- (1)  $H_i$  admits a satellite diagram of non-meridional and non-longitudinal slope, or



(2)  $K$  has a 1-bridge diagram with no crossings on  $H_i$  such that the diagram intersects each component of  $H_1 \cap H_2$  in a single point.

Proof. Since  $A_{j_1}$  and  $A_{j_2}$  are of the form of Lemma C.3 (2),  $H_i$  has a semi-satellite diagram of non-longitudinal and non-meridional slope. More precisely, there is a cancelling disc  $C_{ik}$  of  $t_{ik}$  in  $(V_{ik}, t_{ik})$  such that  $\partial C_{ik} \cap H_i$  is disjoint from a component, say  $l_{ik}$ , of  $H_1 \cap H_2$  for  $k = 1$  and  $2$ . If  $l_{i_1}$  and  $l_{i_2}$  are the same component of  $H_1 \cap H_2$ , then the semi-satellite diagram is a satellite diagram, which is the conclusion (1). Hence we can assume  $l_{i_1} \neq l_{i_2}$ .

We retake the cancelling disc  $C_{ik}$  so that it intersects  $l_{ih}$  in minimum number of points for  $(k, h) = (1, 2)$  and  $(2, 1)$ . Let  $n_k$  be the number of intersection points of  $\partial C_{ik} \cap l_{ih}$ . We will show that  $n_k = 1$  for  $k = 1$  and  $2$ .

For  $(i, j) = (1, 2)$  and  $(2, 1)$  and  $k \in \{1, 2\}$ ,  $A_{jk}$  is isotopic in  $(V_{ik}, t_{ik})$  to the annulus which is the union of the two annuli  $R_{k_1}$  and  $R_{k_2}$  as below.  $R_{k_1}$  is obtained by cutting a copy of  $H_i$  along  $l_{ik}$  and isotoping along  $C_{ik}$ .  $R_{k_2}$  is obtained from a copy of one of the two annuli on  $H_i$  between the loops  $H_1 \cap H_2 = l_{i_1} \cup l_{i_2}$  by slightly isotoping into  $\text{int } V_{ik}$ .  $R_{k_1}$  is disjoint from  $K$ , and  $R_{k_2}$  intersects  $K$  in a single point.

**Sublemma 12.2.**  $n_k = 1$  for  $k = 1$  and  $2$ .

Proof. If  $R_{1_2}$  and  $R_{2_2}$  are copies of the same annulus  $A_{i_1}$  or  $A_{i_2}$ , say  $A_{i_1}$ , then  $H_j$  is isotopic to a union of two parallel copies of  $A_{i_2}$  in  $M$  (ignoring  $K$ ), and hence the loops  $\partial A_{i_2}$  are of longitudinal slope of one of  $V_{i_1}$  and  $V_{i_2}$  because  $H_j$  is a Heegaard splitting torus. This is a contradiction. See Fig. 12.1.

Hence we can assume that  $R_{k_2}$  is a copy of  $A_{ik}$  for  $k \in \{1, 2\}$ . See Fig. 12.2. We can isotope  $H_j$  so that  $R_{k_2}$  is contained in  $A_{ik}$ , that one component of  $\partial R_{k_2}$  coincides with  $l_{ih}$  and the other is contained in  $\text{int } A_{ik}$  and is very close to  $l_{ik}$  for  $(k, h) = (1, 2)$  and  $(2, 1)$ .

Set  $A'_{ik} = \text{cl}(A_{ik} - R_{k_2})$  after the isotopy. Then  $t_{ih} = t_{jk}$  for  $(i, j) = (1, 2)$  and  $(2, 1)$  and for  $(k, h) = (1, 2)$  and  $(2, 1)$ . Note that  $(\partial C_{ih} \cap H_i) \subset (R_{1_2} \cup A'_{i_1} \cup R_{2_2})$  for  $(k, h) = (1, 2)$  and  $(2, 1)$ .

$A'_{ik}$  is  $K$ -incompressible and  $K$ - $\partial$ -incompressible in  $(V_{jk} \cap V_{ik}, K \cap (V_{jk} \cap V_{ik}))$  since  $H_1 \cap H_2$  is of non-meridional and non-longitudinal slope of  $V_{ik}$ . It is also  $K$ -incompressible in  $(V_{jk} \cap V_{ih}, K \cap (V_{jk} \cap V_{ih}))$  since  $H_1 \cap H_2$  is of non-meridional slope of  $V_{ih}$ . Since  $A'_{ik}$  is  $K$ -compressible or  $K$ - $\partial$ -compressible in  $(V_{jk}, t_{jk})$  by Lemma 2.10,  $A'_{ik}$  has a  $K$ - $\partial$ -compressing disc  $P$  in  $V_{jk} \cap V_{ih}$ . We leave the proof of the next claim to readers. See Fig. 12.3, where  $A'_{ik}$  is contracted to  $l_{ik}$ .

CLAIM 12.3. Let  $D$  be a disc properly embedded in the solid torus  $V_{jk} \cap V_{ih}$ . Suppose that  $D$  is a  $K$ -compressing disc of the toral boundary of the solid torus, and is disjoint from  $C_{ih}$ . Then  $\partial D$  intersects  $A'_{ik}$  in  $n_h$  or larger number of arcs. If  $\partial D$  in-

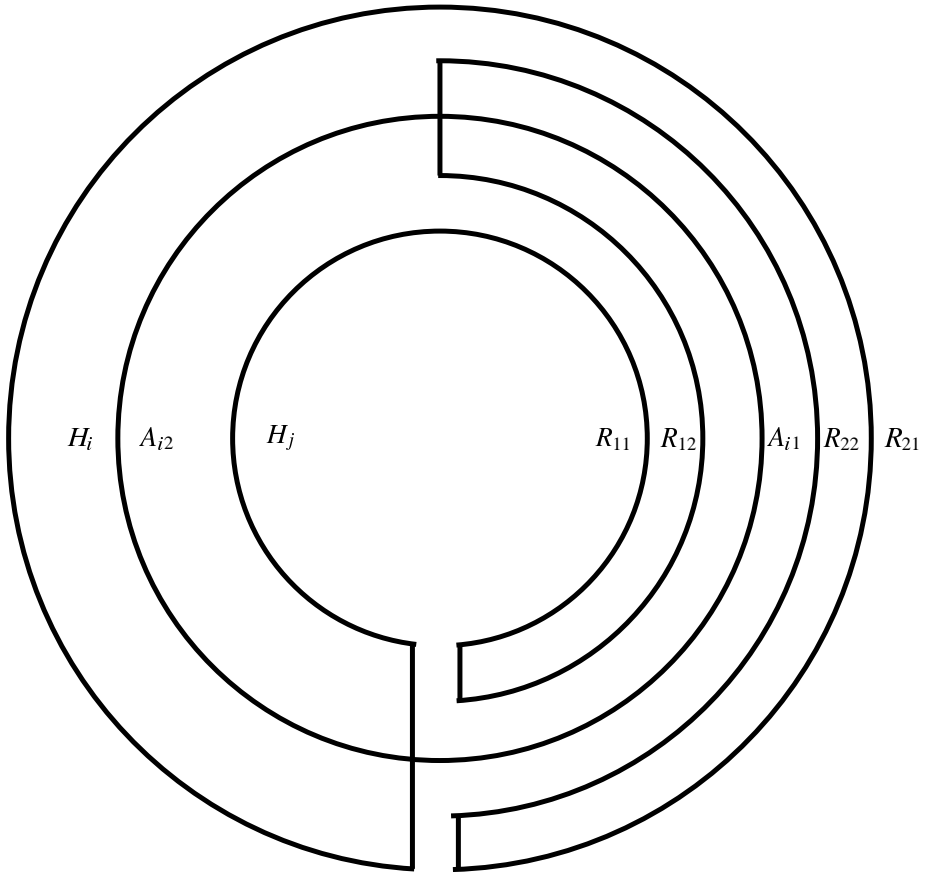

Fig. 12.1.

tersects  $A'_{ik}$  in just  $n_h$  arcs, then  $D$  is a meridian disc of  $V_{jk} \cap V_{ih}$ .

Recall that  $P$  is a  $K$ - $\partial$ -compressing disc of  $A'_{ik}$  in  $V_{jk} \cap V_{ih}$ .  $\partial P$  intersects  $A'_{ik}$  in a single essential arc. We retake  $P$  among all such  $K$ - $\partial$ -compressing discs so that  $\partial P$  intersects  $\partial C_{ih} \cap H_i$  in minimum number of points. A standard innermost loop argument allows us to isotope  $P$  so that each component of  $P \cap C_{ih}$  is an arc rather than a loop.

If  $P$  is disjoint from  $C_{ih}$ , then Claim shows that  $\partial P$  intersect  $A'_{ik}$  in  $n_h$  or larger number of arcs. In fact,  $\partial P \cap A'_{ik}$  consists of a single arc, and hence we obtain  $n_h = 1$  as desired. We consider the case  $P \cap C_{ih} \neq \emptyset$ . We can isotope  $P$  near  $\partial P$  so that  $\partial P \cap \partial C_{ih} \cap A'_{ij} = \emptyset$ . Let  $\rho$  be an arc of  $P \cap C_{ih}$  such that  $\rho$  is outermost away from  $A'_{ik}$  on  $P$ . That is,  $\rho$  cuts off a disc  $P'$  from  $P$  such that  $\partial P'$  is disjoint from  $A'_{ik}$ . The arc  $\rho$  divides  $C_{ih}$  into two discs  $C'$  and  $C''$  where  $\partial C'$  is disjoint from  $t_{ih}$  and

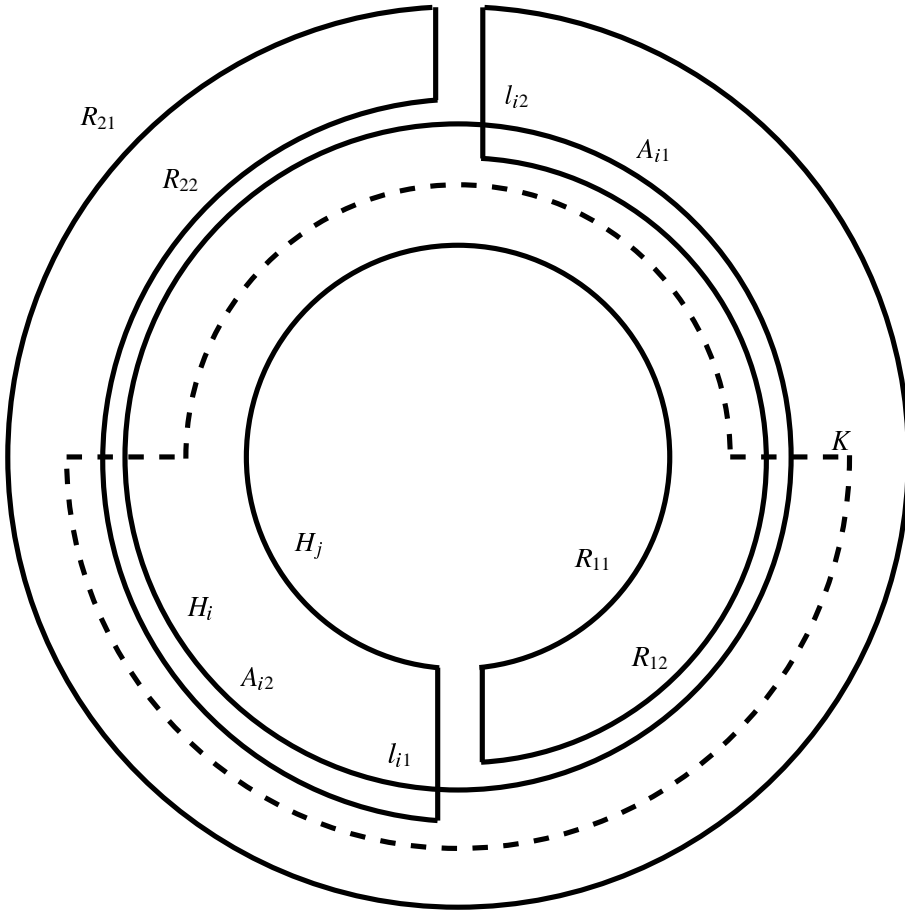

Fig. 12.2.

$\partial C''$  contains  $t_{ih}$  entirely. Let  $D$  be a disc obtained from the disc  $C' \cup P'$  by isotoping slightly to be disjoint from  $C_{ih}$ .

We first suppose that  $D$  is not a  $K$ -compressing disc of the torus  $\partial V = \partial(V_{jk} \cap V_{ih})$ . Then  $\partial D$  bounds a disc  $D'$  on  $\partial V$  such that  $D'$  is disjoint from  $K$ . Note that  $\partial P'$  may intersect  $R_{h1}$ , while  $\partial C'$  does not intersect  $R_{h1}$ , and that  $\partial C'$  may intersect  $A'_{ik}$ , while  $\partial P'$  does not intersect  $A'_{ik}$ . Hence we can isotope  $P'$  near the arc  $\partial P' \cap \partial V$  so that  $P'$  does not intersect  $R_{h1} \cup A'_{ik}$ . See Fig. 12.4. If  $\partial C' \cap A'_{ik} \neq \emptyset$ , then the disc  $C'' \cup P'$  gives a cancelling disc of  $t_{ih}$  which intersects  $A'_{ik}$  in smaller number of arcs. This is a contradiction.

If  $\partial C' \cap A'_{ik} = \emptyset$ , then let  $\mu$  be an outermost arc of  $P \cap C_{ih}$  on  $C'$ , and  $C'''$  the outermost disc.  $\mu$  cuts  $P$  into two discs, one of which, say  $P''$ , intersects  $A'_{ik}$  in a single arc. Then  $P'' \cup C'''$  gives a  $K$ - $\partial$ -compressing disc of  $A'_{ik}$ , intersecting  $\partial C_{ih}$  in

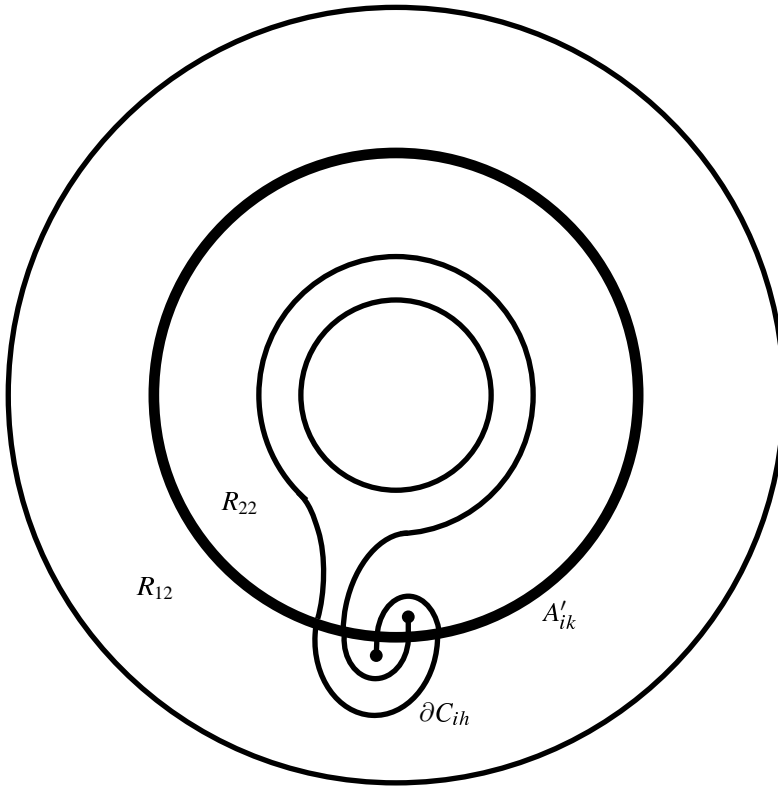

Fig. 12.3.

smaller number of points than  $P$ . This is again a contradiction.

Hence we can assume that  $D$  is a  $K$ -compressing disc of  $\partial V$ . By Claim 12.3,  $\partial D$  intersects  $A'_{ik}$  in  $n_h$  or more arcs. Since  $n_h = |\partial C_{ih} \cap l_{jk}|$ , and since  $\partial P' \cap A'_{ik} = \emptyset$ , the arc  $\partial C' \cap H_i$  intersects  $A'_{ik}$  in  $n_h$  arcs, and also  $\partial D$  does in only  $n_h$  arcs. Hence  $\partial D$  is a meridian disc of  $V$ , and the arc  $\partial P' \cap \partial V$  must intersect  $R_{h1}$ . Moreover, the two arcs  $(\partial C_{ih} - \partial C') \cap H_i$  do not intersect  $A'_{ik}$ . One of them and a subarc of  $\partial P' \cap \partial V$  give an arc in  $R_{12}$  such that it connects a point of  $K \cap H_i$  and a component of  $\partial R_{h1}$ , and is disjoint from the arc  $\partial C_{ih} \cap H_i$ . Hence there is no arc component of  $\partial C_{ih} \cap R_{12}$  with both endpoints in the same component of  $\partial R_{12}$ . Then we obtain  $n_h = 1$ .  $\square$

Thus we have shown that  $\partial C_{ih}$  intersects the loop  $l_{ik}$  in a single point for  $(k, h) = (1, 2)$  and  $(2, 1)$ . Then we can take the discs  $C_{i1}$  and  $C_{i2}$  so that  $\partial C_{i1} \cap \partial C_{i2} = K \cap H_i$ . (In general, there is only a single isotopy class of arcs connecting a fixed point in an annulus and a fixed boundary component of the annulus.) This implies that  $K$  has a 1-bridge diagram on  $H_i$  with no crossing points.  $\square$

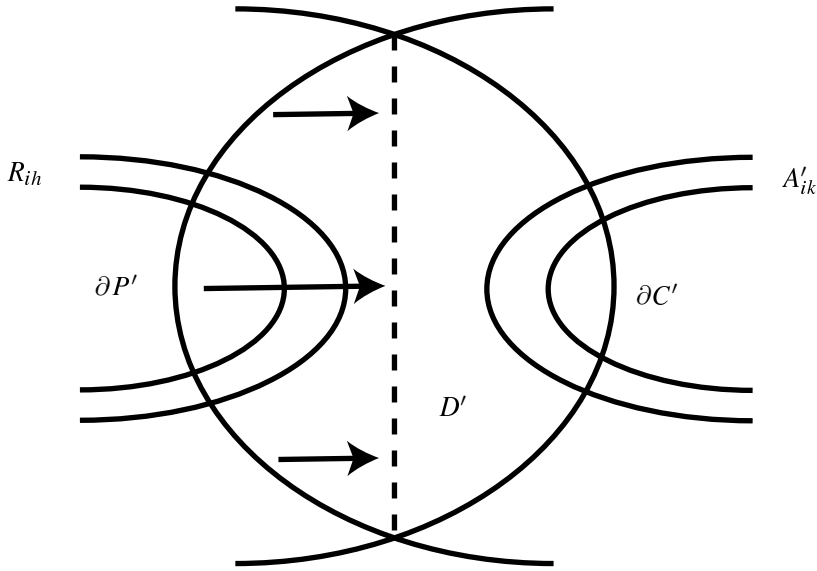

Fig. 12.4.

In the case of Lemma 12.1 (2),  $K$  is a torus knot. If  $K$  is the trivial knot or a core knot, then  $H_1$  and  $H_2$  are weakly  $K$ -reducible as noted in Section 3. Hence we obtain the conclusion (2) of Theorem 1.2. If  $K$  is neither the trivial knot nor a core knot, then  $H_i$  is “cancellable” by the result of Theorem 3 in [27]. That is, for  $i = 1$  and  $2$ , there is a cancelling disc  $C_{ik}$  of  $t_{ik}$  for  $k = 1$  and  $2$  such that  $\partial C_{i1} \cap \partial C_{i2} = K \cap H_i$ . The loop  $K' = (\partial C_{i1} \cup \partial C_{i2}) \cap H_i$  is isotopic to  $K$  and is of non-meridional and non-longitudinal slope. Its exterior  $E(K') = M - \text{int } N(K')$  has a Seifert fibering structure over a disc with two exceptional fibres such that  $H_i \cap E(K')$  is a vertical essential annulus with respect to the fibering. Note that such an annulus is unique up to isotopy in  $E(K')$ . Hence  $H_1$  and  $H_2$  are isotopic in  $(M, K)$ , and we obtain the conclusion (1) of Theorem 1.2.

**13. An example of case (b)**

We give an example of a pair of a once punctured lens space  $X$  and two disjoint arcs  $s_1$  and  $s_2$  properly embedded in  $X$  as described in the conclusion (b) of Theorem 1.3. That is, the exterior  $E_i = \text{cl}(X - N(s_i))$  of the string  $s_i$  is a solid torus, and the other arc  $s_j$  is trivial in  $E_i$  for  $(i, j) = (1, 2)$  and  $(2, 1)$ . We will give an example where  $s_1$  and  $s_2$  are not “parallel”.

The exterior  $E = \text{cl}(X - N(S))$  of the two strings is homeomorphic to a handlebody of genus two since  $E$  is the exterior of  $s_2$  in  $E_1$ . In Fig. 13.1 we can find the boundary of the ball  $B$  obtained from  $E$  by cutting along two discs  $D_1$  and  $D_2$ . We

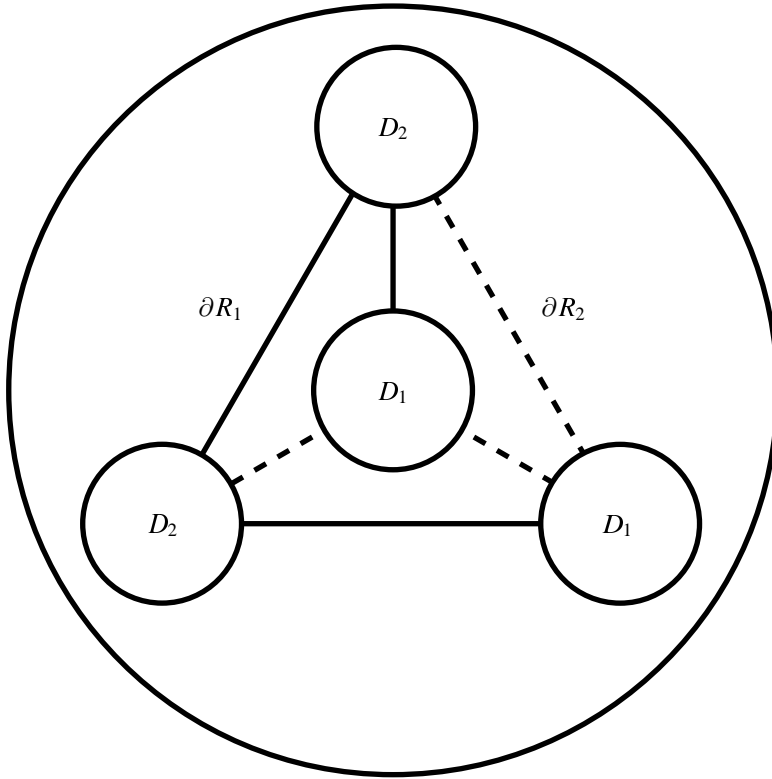

Fig. 13.1.

can find two copies of  $D_i$  in the figure for  $i = 1$  and  $2$ . The neighbourhood  $N(s_i)$  of  $s_i$  contains a meridian disc  $R_i$  of  $s_i$ . That is, by some homeomorphism  $N(s_i) \cong D^2 \times s_i$  with  $D^2 \times \partial s_i = N(s_i) \cap \partial X$ , the disc  $R_i$  is mapped to  $D^2 \times p$ , where  $p$  is a point of  $\text{int } s_i$ . In the figure,  $\partial R_1$  is described by three solid lines, and  $\partial R_2$  is described by three broken lines. The four copies of  $D_1$  and  $D_2$  and these six lines together form vertices and edges of a 1-skelton  $\Delta$  of a tetrahedron. Note that neither the union of the three solid lines nor the union of the three broken lines forms a triangle. Each copy of  $D_i$  intersects  $\partial R_i$  in a single point, and intersects  $\partial R_j$  in two points for  $(i, j) = (1, 2)$  and  $(2, 1)$ . We can recover  $E_j$  by attaching the 2-handle  $N(s_i)$  on  $E$  along  $\partial R_i$ .  $D_i$  shows that  $s_i$  is trivial in  $E_j$ .

We will show that  $s_1$  and  $s_2$  are not “parallel” in  $(X, S)$ . The arcs  $s_1$  and  $s_2$  are *parallel* if there is a disc  $P$  properly embedded in  $E$  such that  $P \cap \partial R_i$  is a single point for  $i = 1$  and  $2$ . We assume, for a contradiction, that there is such a disc  $P$ . We take  $P$  so that it intersects  $\partial D_1 \cup \partial D_2$  in minimum number of points over all the discs of parallelism. A standard innermost argument allows us to isotope  $P$  so that  $P$  intersects  $D_1$  and  $D_2$  in arcs only. Then there is an outermost arc  $\alpha$  of  $(D_1 \cup D_2) \cap P$

on  $P$ , that is,  $\alpha$  cuts off a disc, say  $Q$ , from  $P$  such that  $Q \cap (D_1 \cup D_2) = \alpha$ . We can take  $\alpha$  so that  $\partial Q \cap (\partial R_1 \cup \partial R_2)$  is empty or a single point. The arc  $\beta = \partial Q \cap \partial P$  is contained in the 2-sphere  $\partial B$ , and has both endpoints in the same copy  $D$  of  $D_1$  or  $D_2$ . If  $\beta$  does not intersect  $\partial R_1 \cup \partial R_2$ , then it is entirely contained in a single face of the tetrahedron, and hence we can isotope  $P$  near  $\beta$  in  $E$  so that  $\partial P$  intersects  $\partial D_1 \cup \partial D_2$  in smaller number of points. This is a contradiction. If  $\beta$  intersects  $\partial R_1 \cup \partial R_2$  in a single point, then it is contained in a union of two adjacent faces of the tetrahedron. Hence  $\beta$  and a subarc, say  $\gamma$ , of  $\partial D$  cobound a disc  $O$  intersecting  $\partial R_1 \cup \partial R_2$  in a single arc connecting  $\beta$  and  $\gamma$ . We can isotope  $P$  along  $O$  so that  $\partial P$  intersects  $\partial D_1 \cup \partial D_2$  in smaller number of points, which is a contradiction. Thus  $P$  is disjoint from  $D_1$  and  $D_2$ .  $\partial P$  is contained in  $\partial B$  so that it is disjoint from the four vertices of the tetrahedron. Since  $\partial P$  intersects the 1-skelton  $\Delta$  of the tetrahedron in two points, it is contained in a union of two adjacent faces and bounds a disc intersecting  $\Delta$  in a subarc of an edge. Then  $\partial P$  intersects  $\partial R_i$  in two points for  $i = 1$  or  $2$ , which is a contradiction.

Similar argument shows that  $s_i$  is not trivial in  $(X, S)$  for  $i = 1$  and  $2$ , that is, there is a disc  $P_i$  properly embedded in  $E$  so that  $\partial P_i$  intersects  $\partial R_i$  in a single point and is disjoint from  $\partial R_j$  neither for  $(i, j) = (1, 2)$  nor  $(2, 1)$ .

Similar situations are studied in Lemma 2.3.2 in [2], [10], [12].

**A. Annuli disjoint from  $t$**

Let  $V$  be a solid torus, and  $t$  a trivial arc in  $V$ . Let  $A$  be an annulus properly embedded in  $V$  with  $A \cap t = \emptyset$ .

**Lemma A.1.** *Suppose that the loops of  $\partial A$  are essential on  $\partial V$ . Let  $A_1$  and  $A_2$  be the annuli obtained by cutting  $\partial V$  along  $\partial A$ . Suppose  $\partial t \subset A_1$ . Let  $R_i$  be the region bounded by the torus  $A_i \cup A$  in  $V$ . Then one of the three conditions below holds.*

- (1)  *$A$  is  $t$ -compressible, the loops  $\partial A$  bound meridian discs of  $V$  disjoint from a cancelling disc of  $t$ . Moreover, if  $R_1$  contains a  $t$ -compressing disc of  $A$ , then  $A_2$  is  $t$ -incompressible in  $R_2$ .*
- (2)  *$A$  has a  $t$ - $\partial$ -compressing disc in  $R_2$ , and is  $t$ -parallel to  $A_2$ .*
- (3)  *$A$  has a  $t$ - $\partial$ -compressing disc  $D$  in  $R_1$ , and there is a cancelling disc  $C$  of  $t$  such that  $\partial C \cap \partial V \subset \text{int } A_1$  and  $C \cap (A \cup D) = \emptyset$ .*

*Moreover, if the slope of  $\partial A$  is longitudinal on  $\partial V$ , then (2) holds.*

**Proof.** Lemma 2.10 implies that  $A$  is  $t$ -compressible or  $t$ - $\partial$ -compressible in  $(V, t)$ . Suppose that  $A$  has a  $t$ -compressing disc  $Q$ . Since  $A \cap t = \emptyset$ ,  $\partial Q$  divides  $A$  into two annuli. We perform a  $t$ -compressing operation on  $A$  along  $Q$ , that is, take a tubular neighbourhood  $N \cong Q \times [0, 1]$  of  $Q$  so that  $N \cap A = \partial Q \times [0, 1]$ , and we deform  $A$  into the surface  $(A - (\partial Q \times [0, 1])) \cup (Q \times \{0\} \cup Q \times \{1\})$ . Then we obtain

meridian discs  $D_1, D_2$  disjoint from  $t$  and bounded by  $\partial A$ . Then a standard innermost loop and outermost arc argument allows us to take a cancelling disc of  $t$  to be disjoint from  $D_1, D_2$ .

Suppose  $Q \subset R_1$ . We take a straight arc  $\alpha$  in  $N \subset R_1$  connecting  $Q \times \{0\}$  and  $Q \times \{1\}$ . After the  $t$ -compressing operation,  $\alpha$  connects  $D_1$  and  $D_2$ , and is contained in the ball bounded by  $D_1 \cup D_2 \cup A_2$  in  $V$ . If  $A_2$  has a  $t$ -compressing disc  $P$ , then  $\partial P$  separates  $\partial D_1$  and  $\partial D_2$  on  $A_2$  because  $A_2 \cap t = \emptyset$ . Hence  $P$  must intersect  $D_1 \cup D_2$  or  $\alpha$ , and cannot be contained in  $R_2$  entirely.

Suppose that  $A$  is  $t$ - $\partial$ -compressible. Since  $A$  is disjoint from  $t$ , any  $t$ - $\partial$ -compressing disc intersects  $A$  in an essential arc. Performing a  $t$ - $\partial$ -compressing operation on  $A$ , we obtain a disc, say  $D$ , in  $V$ . Since the loops  $\partial A$  are essential on  $\partial V$ ,  $\partial D$  bounds a disc, say  $D'$ , on  $\partial V$ , and the 2-sphere  $D \cup D'$  bounds a ball, say  $B$ , in  $V$ . If  $B$  does not contain  $t$ , then  $D$  is  $t$ -parallel to  $D'$ , and  $A$  is also  $t$ -parallel to an annulus in  $\partial V$ . If  $t \subset B$ , then a standard innermost loop and outermost arc argument allows us to take a cancelling disc  $C$  of  $t$  with  $C \cap D = \emptyset$  in  $B$ .

If the slope of  $\partial A$  is longitudinal, then it is well-known that in both regions  $R_1$  and  $R_2$   $A$  has  $\partial$ -compressing discs, which in  $R_2$  is disjoint from  $t$ .  $\square$

**Lemma A.2.** *Suppose that a component, say  $l_1$ , of  $\partial A$  is essential on  $\partial V$  and the other component, say  $l_2$ , is not. Let  $Q$  be the disc bounded by  $l_2$  on  $\partial V$ . Suppose  $\partial t \subset Q$ . Then (1)  $l_1$  bounds a meridian disc, say  $D_1$ , with  $D_1 \cap (t \cup (A - l_1)) = \emptyset$ , (2)  $l_2$  bounds a peripheral disc, say  $D_2$ , with  $D_2 \cap (t \cup (A - l_2)) = \emptyset$ , and (3) there is a cancelling disc  $C$  of  $t$  with  $\partial C \cap \partial V \subset Q$  and  $C \cap D_2 = \emptyset$ .*

*Proof.* By Lemma 2.10,  $A$  is  $t$ -compressible or  $t$ - $\partial$ -compressible in  $(V, t)$ .

Suppose that  $A$  is  $t$ -compressible. Since  $A \cap t = \emptyset$ , performing a  $t$ -compressing operation on a copy of  $A$ , we obtain a meridian disc  $D_1$  bounded by  $l_1$ , and a peripheral disc  $D_2$  bounded by  $l_2$  disjoint from  $t$ . An adequate small isotopy makes their interior be disjoint from  $A$ . A standard innermost loop and outermost arc argument allows us to take a cancelling disc  $C$  of  $t$  with  $C \cap D_2 = \emptyset$ . Since  $\partial t \subset Q$ , the arc  $\partial C \cap H_1$  is contained in  $Q$ .

Suppose that  $A$  is  $t$ - $\partial$ -compressible. Since  $A \cap t = \emptyset$ , performing a  $t$ - $\partial$ -compressing operation on  $A$ , we obtain a meridian disc, say  $D$ , of  $V$  with  $D \cap A = \emptyset$  after an adequate small isotopy. Then  $\partial D$  and  $l_1$  together divide  $\partial V$  into two annuli, one of which, say  $R$ , does not contain  $Q$ . Pushing the disc  $D \cup R$  slightly into  $\text{int } V$ , we obtain a  $t$ -compressing disc of  $A$ . Then the previous paragraph shows the lemma.  $\square$

**Lemma A.3.** *Suppose that both components of  $A$ , say  $l_1$  and  $l_2$ , are inessential and  $t$ -essential on  $\partial V$ . Assume that  $l_1$  bounds a disc  $Q$  disjoint from  $l_2$  on  $\partial V$ . Let  $A'$  be the annulus on  $\partial V$  such that  $\partial A' = \partial A$ . Then one of two conditions below holds.*

(1)  $A$  is  $t$ -parallel to  $A'$  in  $(V, t)$ .



(2)  $A$  is  $t$ -compressible in  $(V, t)$ ,  $l_1$  and  $l_2$  bound peripheral discs  $Q_1, Q_2$  disjoint from  $t$ , and there is a cancelling disc  $C$  of  $t$  with  $\partial C \cap \partial V \subset Q$  and  $C \cap (Q_1 \cup Q_2) = \emptyset$ .

Proof. By Lemma 2.10,  $A$  is  $t$ -compressible or  $t$ - $\partial$ -compressible in  $(V, t)$ .

Suppose that  $A$  is  $t$ -compressible. Performing a  $t$ -compressing operation on  $A$ , we obtain peripheral discs  $Q_1, Q_2$  disjoint from  $t$  and bounded by  $l_1$  and  $l_2$  respectively. Since  $l_1$  is  $t$ -essential,  $\partial t \subset Q$ . Then a standard innermost loop and outermost arc argument allows us to take a cancelling disc  $C$  of  $t$  with  $C \cap Q_1 = \emptyset$  and  $\partial C \cap \partial V \subset Q$ .

Suppose that  $A$  has a  $t$ - $\partial$ -compressing disc  $D$ . The arc  $D \cap \partial V$  connects  $l_1$  and  $l_2$ , and hence is contained in the annulus  $A'$ . Performing a  $t$ - $\partial$ -compressing operation on  $A$ , we obtain a peripheral disc, which is  $t$ -parallel to a disc in  $A'$  since  $A' \cap \partial t = \emptyset$ . Hence  $A$  is  $t$ -parallel to  $A'$ . □

**B. Discs with two punctures**

Let  $V$  be a solid torus, and  $t$  a trivial arc in  $V$ . Let  $Q$  be a peripheral disc properly embedded in  $V$  such that  $t$  intersects  $Q$  transversely in two points. Let  $B$  be the ball cut off from  $V$  by  $Q$ , and set  $Q' = \partial B \cap \partial V$  the disc,  $V' = \text{cl}(V - B)$  and  $t' = t \cap V'$ .

**Lemma B.1.** *Assume  $\partial t \subset Q'$ . Then  $t'$  is an arc. Suppose that  $Q$  has a  $t$ -compressing disc  $D$  in  $(V, t)$ . Let  $D'$  be the disc bounded by  $\partial D$  on  $Q$ , and set  $R = (Q - D') \cup D$ . Then (1)  $t$  intersects  $D'$  in two points,  $R \cap t = \emptyset$  and  $D$  is contained in  $V'$ , (2) we can take a cancelling disc  $C$  of  $t$  in  $(V, t)$  with  $C \cap R = \emptyset$  and  $\partial C \cap \partial V \subset Q'$  and (3) we can take a cancelling disc  $C'$  of the arc  $t'$  in  $(V', t')$  with  $C' \cap D = \emptyset$  and  $\partial C' \cap \partial V' \subset D'$ .*

Proof.  $\partial D$  is essential on  $Q - t$ . If  $t$  intersects  $D'$  at a single point, then  $t$  intersects the 2-sphere  $D \cup D'$  in a single point, which contradicts that  $V$  is irreducible. Hence  $t$  intersects  $D'$  in two points, and  $\partial D$  is parallel to  $\partial Q$  on  $Q - t$ . Suppose, for a contradiction, that  $D$  is contained in  $B$ . Then  $D$  divides  $B$  into two balls, both of which intersect  $t$ . This contradicts  $D \cap t = \emptyset$ . Thus we have shown that  $D$  is contained in  $V'$ , and (1) follows.

A standard innermost loop and outermost arc argument allows us to take a cancelling disc  $C$  of  $t$  in  $V$  with  $C \cap R = \emptyset$ . Then (2) follows from  $\partial t \subset Q'$ . Similar argument shows (3). □

**Lemma B.2.** *Suppose that  $Q$  is  $t$ -incompressible in  $(V, t)$ . Then*

- (1)  $\partial t \subset Q'$ , and hence  $t'$  is an arc in  $V'$ ,
- (2) any cancelling disc  $C$  of  $t$  can be isotoped in  $(V, t)$  so that  $C \cap Q$  consists of arcs only and that the two points  $t \cap Q$  are contained in distinct arc components of  $C \cap Q$ ,
- (3)  $(B, t \cap B)$  is a rational tangle, that is, a trivial 2-string tangle and

(4) *the punctured torus  $\partial V \cap \partial V' = \text{cl}(\partial V - Q')$  is  $t$ -incompressible in  $(V', t')$ .*

Proof. If  $Q'$  contains a single endpoint of  $\partial t$ , then  $t$  intersects the 2-sphere  $Q \cup Q'$  in three points, which is a contradiction. If  $Q' \cap \partial t = \emptyset$ , then  $Q'$  gives a  $t$ -compressing disc of  $Q$ , which contradicts our assumption. Hence  $\partial t \subset Q'$ , which is the conclusion (1).

Let  $C$  be a cancelling disc of  $t$  in  $V$ . Since  $Q$  is  $t$ -incompressible, a standard innermost loop argument allows us to isotope  $C$  in  $(V, t)$  so that  $C \cap Q$  contains no loops. If there is an arc  $\alpha$  of  $C \cap Q$  connecting the two points  $t \cap Q$ , then it cuts off from  $C$  a disc  $D$  with  $\partial D = \alpha \cup t'$ ,  $D \cap Q = \alpha$  and  $D \subset V'$ . We take a small regular neighbourhood  $N$  of  $D$  in  $V'$ . Then the disc  $\text{cl}(\partial N - Q)$  is a  $t$ -compressing disc of  $Q$ , which is a contradiction. Hence the two points  $t \cap Q$  are contained in distinct arc components of  $C \cap Q$ . This is the conclusion (2). Let  $t_1$  and  $t_2$  be the two components of  $t \cap B$ . The arcs  $C \cap Q$  divide  $C$  into subdiscs. There are two subdiscs  $C_1, C_2$  such that  $C_i$  contains a copy of  $t_i$  and that  $C_i \cap t_j = \emptyset$  for  $(i, j) = (1, 2)$  and  $(2, 1)$ . These two subdiscs show that  $(B, t \cap B)$  is a trivial 2-string tangle. Thus we obtain the conclusion (3).

Suppose for a contradiction that the punctured torus  $T = \partial V \cap \partial V'$  is  $t$ -compressible in  $(V', t')$ . Then we compress  $T$  and obtain a disc whose boundary coincides with  $\partial Q$ . This disc is disjoint from the arc  $t'$ , which contradicts that  $Q$  is  $t$ -incompressible.  $\square$

**Lemma B.3.** *Assume  $\partial t \subset Q'$ . Then  $t'$  is an arc. Suppose that  $Q$  has a  $t$ - $\partial$ -compressing disc  $D$  in  $(V', t')$ . Then*

- (1) *the arc  $D \cap Q$  separates the two points  $t \cap Q$  on  $Q$  and  $D$  is a meridian disc of  $V'$ ,*
- (2)  *$V$  has a meridian disc  $R$  intersecting  $t$  in a single point and disjoint from  $Q$ ,*
- (3)  *$Q$  is  $t$ -incompressible in  $(V, t)$  and*
- (4) *there is a cancelling disc  $P$  of  $t'$  in  $(V', t')$  such that*
  - (a)  *$P$  is disjoint from  $D$ ,*
  - (b)  *$P \cap Q$  consists of two arcs each of which contains a point of  $t \cap Q$  and*
  - (c)  *$P \cap R$  is a single arc.*

Proof. The arc  $D \cap Q$  divides  $Q$  into two discs  $Q_1, Q_2$ , each of which intersects  $t$  in a single point. However, the two points  $t \cap Q$  are connected by the arc of  $t'$  in  $V'$ . Hence  $D$  is not separating in  $V'$ , and is a meridian disc of  $V'$ . This is the conclusion (1). Then we can obtain a disc  $R$  as desired by isotoping the disc  $D \cap Q_1$  off of  $Q$  slightly. Note that  $|R \cap t| = |Q_1 \cap t| = 1$ . Thus we obtain the conclusion (2).

We assume, for a contradiction, that  $Q$  is  $t$ -compressible in  $(V, t)$ . Then, by Lemma B.1, there is a cancelling disc  $C'$  of  $t'$  in  $(V', t')$  with  $\partial C' \cap \partial V' \subset Q$ . We can isotope  $C'$  near the arc  $\partial C' \cap Q$  so that  $\partial C' \cap \partial D \cap Q$  is a single point  $p$ . We can

isotope  $C'$  slightly fixing  $\partial C'$  so that it is transverse to  $D$ . Since  $D$  is disjoint from  $t$ ,  $(\partial C') \cap D$  consists of the only one point  $p$ . This contradicts that  $C'$  and  $D$  intersect properly embedded 1-manifold in the disc  $C'$ . Hence  $Q$  is  $t$ -incompressible in  $(V, t)$ . Thus we obtain the conclusion (3).

Let  $C$  be a cancelling disc of  $t$  in  $(V, t)$  as in (2) of Lemma B.2. That is,  $C \cap Q$  consists of arcs only and the two points  $t \cap Q$  are contained in distinct arc components of  $C \cap Q$ . Moreover, we can take  $C$  so that the number of the arc components of  $C \cap Q$  is minimal. Then a standard outermost arc argument shows that an arc of  $C \cap Q$  separates the two points  $t \cap Q$  on  $Q$  if it is disjoint from  $t \cap Q$ . Let  $C'$  be one of subdiscs obtained by cutting  $C$  along the arcs  $C \cap Q$  such that  $C'$  contains  $t'$ . Note that  $C'$  is a cancelling disc of  $t'$  in  $(V', t')$ . We can isotope  $C'$  so that  $\partial C'$  is disjoint from the arc  $D \cap Q$  since the arc  $D \cap Q$  separates the two points  $t \cap Q$  on  $Q$ . Then every arc of  $C' \cap Q$  is parallel to the arc  $D \cap Q$  in  $Q - t$  if it is disjoint from  $t \cap Q$ . We can retake  $C'$  so that it is disjoint from  $D$  by a standard innermost loop and outermost arc argument on  $D$ . Then we add a copy of  $D$  along every arc component of  $C' \cap Q$  if it is disjoint from  $t \cap Q$ . A standard innermost loop and outermost arc argument allows us to retake  $C'$  so that it intersects  $R$  in a single arc. Thus we have obtained a cancelling disc of  $t'$  as desired, and we obtain the conclusion (4).  $\square$

**Lemma B.4.** *Suppose that  $Q$  is  $t$ - $\partial$ -compressible in  $(B, t \cap B)$ . Then  $\partial t \subset Q'$ , and  $Q$  and  $Q'$  are  $t$ -parallel in  $(V, t)$ .*

*Proof.* Let  $D$  be a  $t$ - $\partial$ -compressing disc of  $Q$  in  $(B, t \cap B)$ . The arc  $D \cap Q$  is essential in  $Q - T$ , and hence it divides  $Q$  into two discs, say  $Q_1$  and  $Q_2$ , each of which intersects  $t$  in a single point. The arc  $D \cap Q'$  divides  $Q'$  into two discs, say  $Q'_1$  and  $Q'_2$ , such that  $\partial Q_i \cap \partial Q = \partial Q'_i \cap \partial Q$  for  $i = 1$  and 2. For  $i = 1$  and 2, the 2-sphere  $Q_i \cup Q'_i \cup D$  must intersect  $t$  in even number of points. Because  $Q'$  contains at most two endpoints  $\partial t$ ,  $Q'_i$  contains a single point of  $\partial t$  for  $i = 1$  and 2. Thus  $\partial t \subset Q'$ . Let  $B_i$  be the ball bounded by the 2-sphere  $Q_i \cup Q'_i \cup D$ . Then  $t \cap B_i$  is a trivial arc in  $B_i$  for  $i = 1$  and 2 by Lemma 2.1. Thus  $(B, t \cap B)$  gives a parallelism between  $Q$  and  $Q'$  in  $(V, t)$ .  $\square$

**C. Annuli with a puncture**

Throughout Appendix C, we consider the situation as below. Let  $V$  be a solid torus, and  $t$  a trivial arc in  $V$ . Let  $A$  be an annulus properly embedded in  $V$  intersecting  $t$  transversely in precisely one point. Suppose that  $\partial A$  are essential in  $\partial V$  (ignoring the points  $\partial t$ ). Then they divide  $\partial V$  into two annuli  $A_1$  and  $A_2$ . Let  $R_i$  be the region bounded by  $A_i \cup A$ , and set  $t_i = t \cap R_i$  for  $i = 1$  and 2.

When  $A$  has a  $t$ - $\partial$ -compressing disc  $D$  in  $(V, t)$ , we say  $D$  is *essential* if  $\partial D \cap A$  is an essential arc on  $A$  (ignoring the point  $t \cap A$ ), and say  $D$  is *inessential* if  $\partial D \cap A$  is inessential.

**Lemma C.1.** *Suppose that  $A$  has a  $t$ -compressing disc  $D$  in  $R_1$ . Then  $\partial D$  is essential in  $A$  (ignoring the point  $t \cap A$ ),  $A_1$  is also  $t$ -compressible in  $(R_1, t_1)$ , and  $A_2$  is  $t$ -incompressible in  $(R_2, t_2)$ . Moreover,  $R_1$  is a solid torus, and the arc  $t \cap R_1$  has a cancelling disc  $C'$  in  $R_1$  such that each of  $\partial C' \cap A$  and  $\partial C' \cap \partial V$  is an arc.*

*Proof.* Suppose, for a contradiction, that  $\partial D$  bounds a disc, say  $D'$ , in  $A$ . Since  $\partial D$  is essential in  $A - t$ ,  $D'$  contains  $t \cap A$ . Then the 2-sphere  $D \cup D'$  intersects  $t$  in a single point in  $V$ , which is a contradiction. Hence  $\partial D$  is essential.

A  $t$ -compressing operation on  $A$  along  $D$  yields a disc  $D_1$  disjoint from  $t$  and a disc  $D_2$  intersecting  $t$  transversely in a single point. Then  $D_1$  gives a  $t$ -compressing disc of  $A_1$ .

Similar argument as in the latter half of the first paragraph in the proof of Lemma A.1 shows that  $A_2$  is  $t$ -incompressible in  $(R_2, t_2)$ .

$R_1$  is a solid torus because it is obtained from the ball between  $D_1$  and  $D_2$  by gluing the two copies of the  $t$ -compressing disc  $D$ .  $t$  has a cancelling disc  $C$  in  $V$ . As in the proof of Lemma 2.7, a standard innermost loop and outermost arc argument allows us to take  $C$  so that it intersects  $D_1 \cup D_2$  in a single arc connecting the point  $t \cap D_2$  and  $\partial D_2$ . Moreover, we can take  $C$  to be disjoint from the copies of  $D$ . Then the disc  $C' = C \cap R_1$  gives a cancelling disc of the arc  $t \cap R_1$  as desired.  $\square$

**Lemma C.2.** *Suppose that  $A$  has an essential  $t$ - $\partial$ -compressing disc  $D$  in  $R_1$ . Then  $A$  is  $t$ -parallel to  $A_1$  in  $(V, t)$ .*

*Proof.* Performing a  $t$ - $\partial$ -compressing operation on  $A$  along  $D$ , we obtain a peripheral disc  $Q$ .  $Q$  cuts off a ball  $B$  from  $R_1$  with  $t \cap B = t_1$ .  $t_1$  is trivial in  $B$  by Lemma 2.1. Hence  $A$  and  $A_1$  are  $t$ -parallel.  $\square$

**Lemma C.3.** *Suppose that  $A$  is  $t$ -incompressible and has an inessential  $t$ - $\partial$ -compressing disc  $D$  in  $R_1$ . Let  $A'$  be the annulus obtained by performing a  $t$ - $\partial$ -compressing operation on  $A$  along  $D$ . Then either*

- (1)  $A$  is  $t$ -parallel to  $A_1$ , or
- (2) there is a cancelling disc  $C$  of  $t$  in  $(V, t)$  with  $C \cap A' = \emptyset$ .

*If  $\partial A$  is of a longitudinal slope of  $V$ , then the condition (1) holds. In case (2),  $A$  is isotopic in  $(V, t)$  to the annulus which is the union of the two annuli  $Z_1$  and  $Z_2$  as below. See Fig. C.1. Let  $l$  be the component of  $\partial A$  disjoint from  $D$ .*

- (a)  $Z_1$  is obtained by cutting a copy of  $\partial V$  along  $l$  and isotoping along  $C$  and
- (b)  $Z_2$  is obtained from a copy of  $A_1$  by slightly isotoping into  $\text{int } V$ .

*Proof.* The arc  $\partial D \cap A$  cuts off a disc, say  $D_A$ , from  $A$ , with  $t \cap A \subset D_A$ . The arc  $\partial D \cap A_1$  also cuts off a disc, say  $D_1$ , from  $A_1$  with  $\partial t \cap A_1 \subset D_1$ . Then the 2-sphere  $D \cup D_A \cup D_1$  bounds a ball, say  $B$ , in  $R_1$ , with  $t \cap B = t_1$  trivial in  $B$  by

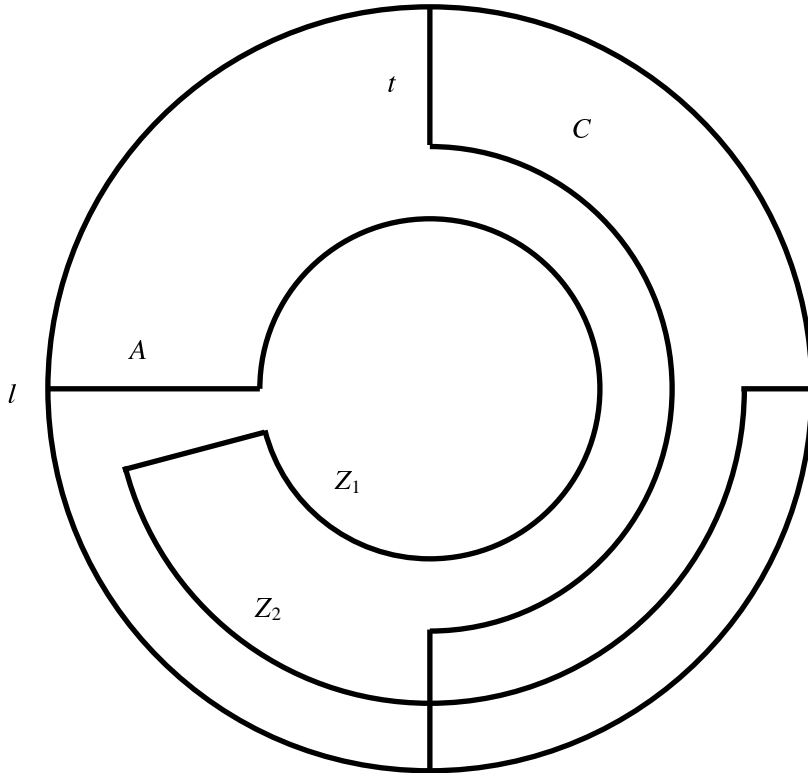

Fig. C.1.

Lemma 2.1. We can recover  $A$  by pushing the interior of  $A' \cup D_1$  into  $\text{int } V$ . We can recover  $A$  also by taking the union of a copy of  $A'$ , two copies of  $\text{cl}(A_1 - D_1)$  and a copy of  $D_1$ .

$A'$  is  $t$ -compressible or  $t$ - $\partial$ -compressible by Lemma 2.10. First, we suppose that  $A'$  is  $t$ -compressible. Let  $P$  be a  $t$ -compressing disc of  $A'$ . We isotope  $P$  near  $\partial P$  so that  $P \cap D = \emptyset$ . Then a standard innermost loop argument allows us to retake  $P$  to be disjoint from  $D$  and  $D_A$ . Then  $P$  forms a  $t$ -compressing disc of  $A$ , contradicting our assumption.

Hence  $A'$  has a  $t$ - $\partial$ -compressing disc  $D'$ . When  $D'$  is contained in  $R_2 \cup B$ , we perform a  $t$ - $\partial$ -compressing operation on a copy of  $A'$  along  $D'$ , and obtain a peripheral disc  $Q$  which cuts off a ball  $B'$  from  $R_2 \cup B$  with  $t \subset B'$ . Hence we can take a cancelling disc  $C$  of  $t$  with  $C \cap Q = \emptyset$  and  $C \subset B'$ . Then  $A'$  is obtained from  $A_2 \cup D_1$  by isotoping along  $C$ . This implies the conclusion (2) by setting  $Z_1 = A' \cup (A_1 - D_1)$  and  $Z_2 = A_1$ .

We consider the case where  $D'$  is contained in  $\text{cl}(R_1 - B)$ . Note that such a  $t$ - $\partial$ -compressing disc always exists if  $\partial A$  is of a longitudinal slope of  $V$ . We can take  $D'$

so that  $D'$  is disjoint from the copy of  $D$ . Hence  $D'$  is also a  $t$ - $\partial$ -compressing disc of  $A$ . Note that the arc  $D' \cap A$  is essential in  $A$  (ignoring the point  $t \cap A$ ). Hence  $A$  and  $A_1$  are  $t$ -parallel in  $(V, t)$  by Lemma C.2.  $\square$

#### D. Annuli with two punctures

In Appendix D, we consider the situation as below. Let  $V$  be a solid torus  $V$ , and  $t$  a trivial arc in  $V$ . Let  $A$  be an annulus properly embedded in  $V$  intersecting  $t$  transversely in two points. Suppose that the loops  $\partial A$  are essential in  $\partial V$  (ignoring the points  $\partial t$ ). Then they divide  $\partial V$  into two annuli  $A_1$  and  $A_2$ , one of which, say  $A_1$  contains the two points  $\partial t$ . The annulus  $A$  separates  $V$  into two regions  $R_1$  and  $R_2$  with  $\partial R_i = A_i \cup A$  for  $i = 1$  and  $2$ . When  $A$  has a  $K$ -compressing disc  $D$  in  $(V, t)$ , we say that  $D$  is *essential* if  $\partial D \cap A$  is essential on  $A$ , otherwise it is *inessential*.

**Lemma D.1.** *Suppose that  $A$  has an inessential  $t$ -compressing disc  $D$  in  $(V, t)$  and is  $t$ - $\partial$ -incompressible in  $(R_2, t \cap R_2)$ . Then there is a cancelling disc  $C$  of  $t$  with  $\partial C \cap \partial V \subset A_1$ .*

*Proof.* Note that  $D$  is contained in  $R_2$ . By performing a compressing operation on  $A$  along  $D$ , we obtain a 2-sphere and an annulus, say  $A'$ .  $A'$  is disjoint from  $t$ , and separates  $V$  into two regions  $R'_1$  and  $R'_2$ , one of which, say  $R'_1$  contains  $t$ . By Lemma 2.10,  $A'$  is  $t$ -compressible or  $t$ - $\partial$ -compressible in  $(V, t)$ .

If  $A'$  is  $t$ -compressible, then, compressing  $A'$ , we obtain two meridian discs of  $V$ . A standard innermost loop and outermost arc argument allows us to take a cancelling disc of  $t$  disjoint from these discs. This implies the conclusion.

If  $A'$  has a  $t$ - $\partial$ -compressing disc  $Q$  in  $R'_2$ , then we can isotope  $Q$  near the arc  $\partial Q \cap A'$  in  $R'_2$  so that  $\partial Q$  is disjoint from the copy of the  $t$ -compressing disc  $D$ . This implies that  $A$  is  $t$ - $\partial$ -compressible in  $(R_2, t \cap R_2)$ , which contradicts our assumption.

If  $A'$  is  $t$ - $\partial$ -compressible in  $R'_1$ , then, performing a  $t$ - $\partial$ -compressing operation on  $A'$ , we obtain a peripheral disc which cuts off a ball containing  $t$  from  $R'_1$ . We can take a cancelling disc of  $t$  entirely contained in the ball. This implies the conclusion.  $\square$

---

#### References

- [1] J. Berge: *The knots in  $D^2 \times S^1$  with non-trivial Dehn surgery yielding  $D^2 \times S^1$* , Topology Appl. **38** (1991), 1–19.
- [2] M. Culler, C.M. Gordon, J. Luecke and P. Shalen: *Dehn surgery on knots*, Annals of Math. **125** (1987), 237–300.
- [3] D.H. Choi and K.H. Ko: *On 1-bridge torus knots*, preprint.
- [4] D.H. Choi and K.H. Ko: *Parametrizations of 1-bridge torus knots*, preprint.

- [5] A. Cattabriga and M. Mulazzani: *Strongly-cyclic branched coverings of  $(1, 1)$ -knots and cyclic presentations of groups*, preprint.
- [6] H. Doll: *A generalized bridge number for links in 3-manifolds*, Math. Ann. **294** (1992), 701–717.
- [7] D. Gabai: *Surgery on knots in solid tori*, Topology **28** (1989), 1–6.
- [8] D. Gabai: *1-bridge braids in solid tori*, Topology Appl. **37** (1990), 221–235.
- [9] H. Goda and C. Hayashi: *Genus two Heegaard splittings of exteriors of 1-genus 1-bridge knots*, preprint.
- [10] C. McA. Gordon: *On primitive sets of loops in the boundary of a handlebody*, Topology Appl. **27** (1987), 285–299.
- [11] L. Grasselli and M. Mulazzani: *Genus one 1-bridge knots and Dunwoody manifolds*, Forum Math. **13** (2001), 379–397.
- [12] C. Hayashi: *On parallelism of strings in tangles*, Topology Appl. **62** (1995), 65–76.
- [13] C. Hayashi: *Genus one 1-bridge positions for the trivial knot and cabled knots*, Math. Proc. Camb. Phil. Soc. **125** (1999), 53–65.
- [14] C. Hayashi: *Satellite knots in 1-genus 1-bridge positions*, Osaka J. Math. **36** (1999), 711–729.
- [15] C. Hayashi: *Stable equivalence of Heegaard splittings of 1-submanifolds in 3-manifolds*, Kobe J. Math. **15** (1998), 147–156.
- [16] C. Hayashi: *A survey of known results on 1-genus 1-bridge knots*, the Proceeding of the conference “On Heegaard splittings and Dehn surgeries of 3-manifolds, and topics related to them”, 10–18, Kyoto University, June 2001.
- [17] C. Hayashi and K. Shimokawa: *Thin position for 1-submanifold in 3-manifold*, Pacific J. Math. **197** (2001), 301–324.
- [18] C. Hayashi and K. Shimokawa: *Heegaard splittings of the trivial knot*, J. Knot Theory Ramifications **7** (1998), 1073–1085.
- [19] C. Hayashi and K. Shimokawa: *Heegaard splittings of trivial arcs in compression bodies*, J. Knot Theory Ramifications **10** (2001), 71–87.
- [20] C. Hayashi and K. Shimokawa: *Heegaard splittings of the pair of the solid torus and the core loop*, Rev. Mat. Complut. **14** (2001), 479–501.
- [21] J. Hempel: *3-manifolds as viewed from the curve complex*, Topology **40** (2001), 631–657.
- [22] P. Hoidn: *On 1-bridge genus of small knots*, Topology Appl. **106** (2000), 321–335.
- [23] T. Kobayashi: *Structures of the Haken manifolds with Heegaard splitting of genus two*, Osaka J. Math. **21** (1984), 437–455.
- [24] T. Kobayashi: *Heegaard splittings of exteriors of two bridge knots*, Geom. Topol. **5** (2001), 609–650.
- [25] T. Kobayashi and O. Saeki: *Rubinstein-Scharlemann graphic of 3-manifold as the discriminant set of a stable map*, Pacific J. Math. **195** (2000), 101–156.
- [26] H. Matsuda: *Genus one knots which admit  $(1, 1)$ -decompositions*, Proc. Amer. Math. Soc. **130** (2002), 787–791.
- [27] K. Morimoto: *On minimum genus Heegaard splittings of some orientable closed 3-manifolds*, Tokyo J. Math. **12** (1989), 321–355.
- [28] K. Morimoto and M. Sakuma: *On unknotting tunnels for knots*, Math. Ann. **289** (1991), 143–167.
- [29] K. Morimoto, M. Sakuma and Y. Yokota: *Examples of tunnel number one knots which have the property ‘ $1 + 1 = 3$ ’*, Math. Proc. Camb. Phil. Soc. **119** (1996), 113–118.
- [30] M. Mulazzani: *Cyclic presentations of groups and branched cyclic coverings of  $(1, 1)$ -knots*, preprint.
- [31] H. Rubinstein and M. Scharlemann: *Comparing Heegaard splittings of non-Haken 3-manifolds*, Topology **35** (1996), 1005–1026.
- [32] H. Rubinstein and M. Scharlemann: *Genus two Heegaard splittings of orientable three-manifolds*, Proceedings of the 1998 Kirbyfest, Geometry and Topology Monographs 2, 489–553.
- [33] M. Scharlemann: *Producing reducible 3-manifolds by surgery on a knot*, Topology **29** (1990), 481–500.

- [34] H.J. Song: *Dunwoody (1, 1)-decomposable knots*, preprint.
- [35] H.J. Song and K.H. Ko: *Spatial  $\theta$ -curve associated with Dunwoody (1, 1)-decomposable knots*, preprint.
- [36] H.J. Song and S.H. Kim: *Dunwoody 3-manifolds and (1, 1)-decomposable knots*, preprint.
- [37] A. Thompson: *The disjoint curve property and genus 2 manifolds*, *Topology Appl.* **97** (1999), 237–279.
- [38] Y.-Q. Wu: *A generalization of the handle addition theorem*, *Proc. Amer. Math. Soc.* **114** (1992), 237–242.
- [39] Y.-Q. Wu: *Incompressibility of surfaces in surgered 3-manifold*, *Topology* **31** (1992), 271–279.
- [40] Y.-Q. Wu:  *$\partial$ -reducing Dehn surgeries and 1-bridge knots*, *Math. Ann.* **295** (1992), 319–331.
- [41] Y.-Q. Wu: *Incompressible surfaces and Dehn surgery on 1-bridge knots in handlebodies*, *Math. Proc. Cambridge Phil. Soc.* **120** (1996), 687–696.

Department of Mathematical and Physical Sciences  
Faculty of Science, Japan Women's University  
2-8-1 Mejirodai, Bunkyo-ku, Tokyo 112-8681, Japan  
e-mail: hayashic@fc.jwu.ac.jp