

## ON THE NIELSEN-THURSTON-BERS TYPE OF SOME SELF-MAPS OF RIEMANN SURFACES WITH TWO SPECIFIED POINTS

Dedicated to Professor Hiroki Sato on his 60th birthday

YOICHI IMAYOSHI, MANABU ITO and HIROSHI YAMAMOTO

(Received February 12, 2002)

### 1. Introduction

**1.1.** Let  $S$  be a hyperbolic Riemann surface of analytically finite type, that is, a hyperbolic Riemann surface obtained by removing  $n_0$  distinct points from a closed Riemann surface of genus  $g_0$  with  $2g_0 - 2 + n_0 > 0$ . Take  $n$  distinct points  $p_1, p_2, \dots, p_n$  of  $S$ , and set  $\dot{S} = S \setminus \{p_1, p_2, \dots, p_n\}$ . We consider the group of orientation preserving homeomorphisms  $\omega$  of  $S$  onto itself which satisfy two conditions

- (1)  $\omega(p_j) = p_j$  for every  $j = 1, 2, \dots, n$ , and
- (2)  $\omega$  is isotopic to the identity self-map  $\text{id}$  of  $S$ .

We factor this group by the normal subgroup of homeomorphisms of  $S$  onto itself that are isotopic to the identity as self-maps of  $\dot{S}$ . Denote the factor group by

$$\text{Isot}(S, \{p_1, p_2, \dots, p_n\}), \text{ or } \text{Isot}(S, n).$$

**1.2.** The purpose of this paper is to classify the elements of  $\text{Isot}(S, n)$  in the case of  $n = 2$ . For  $n = 1$ , it is studied by Kra [10]. Our problem and form of the solution are suggested by his beautiful theorem (Theorem 2 of Kra [10]).

Every element  $[\omega] \in \text{Isot}(S, n)$  induces canonically an element  $\langle \omega|_{\dot{S}} \rangle$  of the Teichmüller modular group  $\text{Mod}(\dot{S})$ . Namely, for the Teichmüller space  $T(\dot{S})$  of  $\dot{S}$ ,  $\langle \omega|_{\dot{S}} \rangle$  is a biholomorphic automorphism of  $T(\dot{S})$  given by  $\langle \omega|_{\dot{S}} \rangle([S, f, R]) = [S, f \circ \omega^{-1}, R]$  for all  $[S, f, R] \in T(\dot{S})$ . Since the correspondence  $\text{Isot}(S, n) \ni [\omega] \mapsto \langle \omega|_{\dot{S}} \rangle \in \text{Mod}(\dot{S})$  is injective, we can classify  $[\omega]$  by a classification for the elements of  $\text{Mod}(\dot{S})$ .

For our classification, we use the following one due to Bers [1] for the elements of  $\text{Mod}(\dot{S})$ . Let  $d_{T(\dot{S})}$  be the Teichmüller distance on  $T(\dot{S})$ , and set

$$a(\chi) = \inf_{\tau \in T(\dot{S})} d_{T(\dot{S})}(\tau, \chi(\tau)).$$

Then, elements  $\chi (\neq \text{id})$  of  $\text{Mod}(\dot{S})$  are classified as follows:

- (1)  $\chi$  is *elliptic* if  $a(\chi) = 0$ , and  $a(\chi) = d_{T(\dot{S})}(\tau_0, \chi(\tau_0))$  for some  $\tau_0$ , i.e.,  $\chi$  has a fixed point  $\tau_0$  in  $T(\dot{S})$ .
- (2)  $\chi$  is *parabolic* if  $a(\chi) = 0$ , and  $a(\chi) < d_{T(\dot{S})}(\tau, \chi(\tau))$  for all  $\tau$ .
- (3)  $\chi$  is *hyperbolic* if  $a(\chi) > 0$ , and  $a(\chi) = d_{T(\dot{S})}(\tau_0, \chi(\tau_0))$  for some  $\tau_0$ .
- (4)  $\chi$  is *pseudo-hyperbolic* if  $a(\chi) > 0$ , and  $a(\chi) < d_{T(\dot{S})}(\tau, \chi(\tau))$  for all  $\tau$ .

**1.3.** In order to characterize  $[\omega] \in \text{Isot}(S, n)$ , we will use the pure braid  $[b_\omega]$  induced by  $[\omega]$ . Let  $h_\omega: S \times I \rightarrow S$  be an isotopy from  $\text{id}$  to  $\omega$ , where  $I$  is the unit interval  $[0, 1]$ . We set

$$M = \underbrace{S \times \cdots \times S}_{n \text{ times}}$$

$$\mathbf{p} = (p_1, p_2, \dots, p_n), \text{ and}$$

$$\Delta = \{(x_1, x_2, \dots, x_n) \in M \mid x_j = x_k \text{ for some } j, k \text{ with } j \neq k\}.$$

Then we have a closed curve  $b_\omega = (s_{\omega,1}, s_{\omega,2}, \dots, s_{\omega,n})$  in  $M \setminus \Delta$  defined by

$$s_{\omega,j}(\cdot) = h_\omega(p_j, \cdot).$$

It is well-known that the map

$$\text{Isot}(S, n) \ni [\omega] \mapsto [b_\omega] \in \pi_1(M \setminus \Delta, \mathbf{p})$$

is well-defined and isomorphic (see Theorem 4.2 of Birman [3] for compact case). The fundamental group  $\pi_1(M \setminus \Delta, \mathbf{p})$  is called the *pure braid group* with  $n$  strings of  $S$ . We call an element  $[b] \in \pi_1(M \setminus \Delta, \mathbf{p})$  a *pure braid* with  $n$  strings of  $S$ , which is represented by a closed path  $b = (s_1, s_2, \dots, s_n): I \rightarrow M \setminus \Delta$  with base point  $\mathbf{p}$ . The maps  $s_j: I \rightarrow S$  are called *strings* of  $b$ . From this point of view, we will characterize the type of  $\langle \omega|_S \rangle \in \text{Mod}(\dot{S})$  by using the pure braid  $[b_\omega]$  induced from  $[\omega]$ .

**1.4.** Now we assume throughout that  $n = 2$  unless otherwise stated. Then we have the following main result.

**Main Theorem.** *Let  $S$  be a hyperbolic Riemann surface of analytically finite type with two specified points  $p_1, p_2 \in S$ , and set  $\dot{S} = S \setminus \{p_1, p_2\}$ . Let  $[\omega]$  be a non-trivial element of  $\text{Isot}(S, 2)$ , which induces an element  $\langle \omega|_S \rangle$  of  $\text{Mod}(\dot{S})$  and a pure braid  $[b_\omega]$  with a representative  $b_\omega = (s_1, s_2)$ .*

*Then the element  $\langle \omega|_S \rangle$  is not elliptic. Moreover,  $\langle \omega|_S \rangle$  is classified as follows:*

- (1)  $\langle \omega|_S \rangle$  is *parabolic* if and only if
  - (1a) each string  $s_j$  of  $b_\omega$  is either a trivial, a parabolic, or a simple hyperbolic closed curve on  $S$ , and

- (1b) the strings  $s_1, s_2$  are separable, or parallel.
- (2)  $\langle \omega|_S \rangle$  is hyperbolic if and only if
  - (2a) the pure braid  $[b_\omega]$  is essential,
  - (2b) the strings  $s_1, s_2$  are not parallel, and
  - (2c) for any puncture  $p$  of  $S$ , each string  $s_j$  is not parallel to  $p$ .

The definitions such as essential, separable, parallel, etc in this statement are given at the beginning of the next section. A part of the above result has been announced without proof in the survey article [9].

Note that in our terminology, Kra’s result (Theorem 2 of Kra [10]) is restated as follows.

**Kra’s Theorem.** *Let  $S$  be a hyperbolic Riemann surface of analytically finite type with one specified point  $p_1$ , and set  $\dot{S} = S \setminus \{p_1\}$ . Let  $[\omega]$  be a non-trivial element of  $\text{Isot}(S, 1)$ , which induces an element  $\langle \omega|_S \rangle$  of  $\text{Mod}(\dot{S})$  and a pure braid  $[b_\omega]$  of one string  $b_\omega = s$ .*

*Then the element  $\langle \omega|_S \rangle$  is not elliptic. Moreover,  $\langle \omega|_S \rangle$  is classified as follows:*

- (1)  $\langle \omega|_S \rangle$  is parabolic if and only if the string  $s$  is either a parabolic or a simple hyperbolic closed curve on  $S$ , and
- (2)  $\langle \omega|_S \rangle$  is hyperbolic if and only if the string  $s$  is essential.

In order to deal with the case for  $n > 2$ , we need to extend the notion that strings are separable or parallel. This will be pursued further in the future.

**1.5.** This paper is organized as follows. In Section 2 we will give some definitions for curves and pure braids on a Riemann surface. We also explain a relation between Bers’ classification and Thurston’s one for elements of Teichmüller modular transformations. We recall distortion theorems of quasiconformal maps and several results on hyperbolic geometry of Riemann surfaces. These facts are used in Section 3 and Section 4. In Section 3, for a given  $[\omega] \in \text{Isot}(S, 2)$  we construct an isotopy from  $\text{id}$  to  $\omega$  in  $S$  with certain good properties, which is called a *canonical isotopy* of  $[\omega]$ . Using the canonical isotopy, we will give a proof of our main theorem in Section 4. We illustrate some examples for the theorem in the final section.

## 2. Preliminaries

**2.1.** First of all, let us give some definitions for curves on a hyperbolic Riemann surface  $R$  of analytically finite type. A simple closed curve  $C$  on  $R$  is said to be *admissible* unless it is deformed continuously into a point or a puncture of  $R$ . A non-trivial element  $[C]$  of the fundamental group of  $R$  is called *parabolic* if  $C$  is deformed continuously into a puncture of  $R$ , *hyperbolic* if it is not. A hyperbolic element  $[C]$  is said to be *simple* if  $C$  is freely homotopic to a power of a simple closed curve on  $R$ .

A hyperbolic element  $[C]$  is called *essential* if any closed curve  $C'$  freely homotopic to  $C$  intersects every admissible simple closed curve on  $R$ . We say that a non-trivial closed curve  $C$  on  $R$  is *parabolic*, *hyperbolic*, *simple hyperbolic*, *essential* if the element  $[C]$  of the fundamental group of  $R$  is parabolic, hyperbolic, simple hyperbolic, essential hyperbolic, respectively.

**2.2.** Next we will give some definitions for pure braids  $[b]$  of two strings on  $R$ .

A pure braid  $[b]$  of two strings on  $R$  is said to be *essential* unless there exists a subdomain  $D$  in  $R$  satisfying the following three conditions:

- (i) the boundary of  $D$  consists of smooth simple closed curves;
- (ii) the subgroup  $i_*(\pi_1(D, *))$  of  $\pi_1(R, *)$  has a hyperbolic element, where  $i: D \hookrightarrow R$  is the inclusion map;
- (iii)  $s'_1(I) \cap D = \emptyset$  and  $s'_2(I) \cap D = \emptyset$  for some representative  $(s'_1, s'_2)$  of  $[b]$ .

We say that the strings  $s_1$  and  $s_2$  of a representative  $b = (s_2, s_2)$  of the pure braid  $[b]$  are *separable* if there exist disjoint non-trivial simple closed curves  $C_1, \dots, C_k \subset R$  and distinct components  $D_1, D_2$  of the complement  $R \setminus (C_1 \cup \dots \cup C_k)$  such that  $s'_1(I) \subset D_1$  and  $s'_2(I) \subset D_2$  for some representative  $(s'_1, s'_2)$  of  $[b]$ .

It is said that  $s_1$  is *parallel* to  $s_2$  if there exists a continuous map  $F: I \times I \rightarrow R$  satisfying the following three conditions:

- (i)  $F(t_1, t_2) \neq s_2(t_1)$  for any  $t_1 \in I, t_2 \in [0, 1)$ ,
- (ii)  $F(\cdot, 0) = s_1(\cdot), F(\cdot, 1) = s_2(\cdot)$ , and
- (iii)  $F(0, \cdot) = F(1, \cdot)$ .

We see that if  $s_1$  is parallel to  $s_2$  then  $s_2$  is parallel to  $s_1$  (see Lemma 8). So we may say that  $s_1$  and  $s_2$  are parallel if  $s_1$  is parallel to  $s_2$ . Note that if  $s_1$  is parallel to  $s_2$  for some representative  $(s_1, s_2)$ , then  $s'_1$  is parallel to  $s'_2$  for all  $(s'_1, s'_2) \in [(s_1, s_2)]$ .

A string  $s_j$  of  $(s_1, s_2)$  is *parallel* to a puncture  $p$  of  $R$  if there exists a continuous map  $F: I \times I \rightarrow R \cup \{p\}$  satisfying the following three conditions:

- (i)  $F(t_1, t_2) \in R \setminus \{s_k(t_1)\}$  for all  $(t_1, t_2) \in I \times [0, 1)$ , where  $k$  is 1 or 2 with  $k \neq j$ ,
- (ii)  $F(\cdot, 0) = s_j(\cdot), F(\cdot, 1) = p$ , and
- (iii)  $F(0, \cdot) = F(1, \cdot)$ .

If  $s_j$  is parallel to a puncture  $p$ , then it turns out that  $s'_j$  is parallel to  $p$  for all representative  $(s'_1, s'_2)$  of  $[(s_1, s_2)]$ .

**2.3.** A finite non-empty set of disjoint simple closed curves  $\{C_1, \dots, C_k\}$  on  $R$  is said to be *admissible* if no  $C_i$  can be deformed continuously into either a point, a puncture of  $R$ , or into a  $C_j$  with  $i \neq j$ . We say that an orientation preserving homeomorphism  $\omega: R \rightarrow R$  is *reduced* by  $\{C_1, \dots, C_k\}$  if  $\{C_1, \dots, C_k\}$  is admissible and if  $\omega(C_1 \cup \dots \cup C_k) = C_1 \cup \dots \cup C_k$ .

A self-map  $\omega$  of  $R$  is called *reducible* if it is not isotopic to the identity map and is isotopic to a reduced map. A self-map of  $R$  is called *irreducible* if it is not reducible. This is a classification for self-maps  $\omega$ , which is introduced by Thurston

(cf. Thurston [14]). Theorem 4 of Bers [1] says that an element  $\langle \omega \rangle \in \text{Mod}(R)$  of infinite order is hyperbolic if and only if  $\omega$  is irreducible.

If  $\omega: R \rightarrow R$  is reduced by  $\{C_1, \dots, C_k\}$ , then we denote by  $R_1, \dots, R_m$  the components of  $R \setminus (C_1 \cup \dots \cup C_k)$ , and call them *parts* of  $R$ . Each surface  $R_j$  is of finite type  $(g_j, n_j)$  with  $2g_j - 2 + n_j > 0$ , and  $\omega$  permutes the parts  $R_j$ . Let  $\alpha_j$  be the smallest positive integer so that  $f^{\alpha_j}$  fixes  $R_j$ . We say that  $\omega$  is *completely reduced* by  $\{C_1, \dots, C_k\}$  if  $f^{\alpha_j}|_{R_j}$  is irreducible for each  $j$ . Lemma 5 of Bers [1] shows that every reducible map is isotopic to a completely reduced map. If  $\omega$  is completely reduced, then the maps  $f^{\alpha_j}|_{R_j}$  are called the components maps of  $\omega$ . A parabolic or pseudo-hyperbolic element  $\chi \in \text{Mod}(R)$  can be always induced by a completely reduced map  $\omega$ . The component maps of  $\omega$  induce elements of Teichmüller modular groups of parts of  $R$ , which is called the *restrictions* of  $\chi$ . The element  $\chi$  is parabolic if all the restrictions are periodic or trivial, and pseudo-hyperbolic if at least one restriction is hyperbolic (see Theorem 7 of Bers [1] and its proof).

**2.4.** Now let us recall distortion theorems of quasiconformal maps. Let  $R$  be a Riemann surface with hyperbolic metric of constant Gaussian curvature  $-1$ . For arbitrary points  $x, y$  on  $R$  and for any curve  $C$  joining  $x$  and  $y$ , there exists a unique geodesic curve  $L_C$  homotopic rel  $x, y$  to  $C$ . Let  $l_R(L_C)$  be the hyperbolic length of  $L_C$  on  $R$ . For any number  $r \in (0, 1)$ , denote by  $\mu(r)$  the modulus of the Grötzsch's ring domain  $\{z \in \mathbf{C} \mid |z| < 1\} \setminus [0, r]$ . It is known that  $\mu(r)$  satisfies  $\lim_{r \rightarrow 1} \mu(r) = 0$  and  $\lim_{r \rightarrow 0} \mu(r) = \infty$  (cf. Chapter II, 2.2 and 2.3 of Lehto and Virtanen [11]).

**Lemma 1** (Chapter II, 3.1 of Lehto and Virtanen [11]). *Let  $R_1$  and  $R_2$  be hyperbolic Riemann surfaces, and let  $f: R_1 \rightarrow R_2$  be a quasiconformal map with maximal dilatation  $K(f)$ . Then*

$$\frac{1}{K(f)} \leq \frac{\mu(\tanh(l_{R_1}(L_C)/2))}{\mu(\tanh(l_{R_2}(L_{f(C)})/2))} \leq K(f)$$

for any curve  $C$  on  $R_1$ .

**Lemma 2** (cf. Teichmüller [13], Gehring [8]). *There exists a strictly increasing real-valued continuous function  $\rho: [1, \infty) \rightarrow [0, \infty)$  satisfying the following conditions:*

- (1)  $\rho(1) = 0$  and  $\lim_{t \rightarrow \infty} \rho(t) = \infty$ .
- (2) *Let  $R$  be a hyperbolic Riemann surface of analytically finite type and  $x$  a point of  $R$ . Then*

$$d_R(x, f(x)) \leq \rho(K(f))$$

for any quasiconformal self-map  $f$  of  $R$  which is isotopic to the identity.

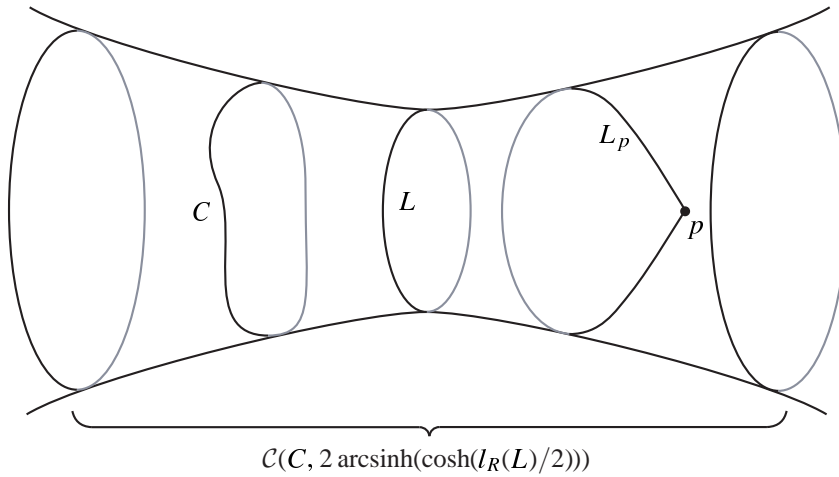

Fig. 1. The collar around  $L$ .

**2.5.** Finally we will give several facts on hyperbolic geometry of a hyperbolic Riemann surface  $R$  of analytically finite type.

For any  $r > 0$  and any non-trivial closed curve  $C$ , denote by  $\mathcal{C}(C, r)$  the set of all points  $p \in R$  such that there exists a closed geodesic loop  $L_p$  satisfying the following three conditions:

- (1)  $L_p$  contains  $p$ ,
- (2)  $L_p$  is freely homotopic to  $C$  on  $R$ , and
- (3)  $l_R(L_p) < r$ .

Using hyperbolic trigonometry and the collar theorem (cf. Buser [4], 2.3.1 and 4.4.6), we get the following (see Fig. 1).

**Lemma 3.** *Let  $L$  be an admissible simple closed geodesic on a hyperbolic Riemann surface  $R$  of analytically finite type, and  $C$  a closed curve on  $R$ . Assume that  $C$  is freely homotopic to the  $m$ -fold iterate  $L^m$  of  $L$  for some positive integer  $m$ . Then for any real number  $r$  satisfying*

$$ml_R(L) < r \leq 2 \operatorname{arcsinh} \left( \left( \sinh \frac{ml_R(L)}{2} \right) \left( \coth \frac{l_R(L)}{2} \right) \right),$$

the set  $\mathcal{C}(C, r)$  is conformally equivalent to an annulus.

For any admissible simple closed geodesic  $C$  on  $R$ , the set

$$\mathcal{C} \left( C, 2 \operatorname{arcsinh} \left( \cosh \frac{l_R(C)}{2} \right) \right)$$

is said to be the *collar* around  $C$ . By Lemma 3, if  $l_R(C) < 2 \operatorname{arcsinh} 1$ , the set

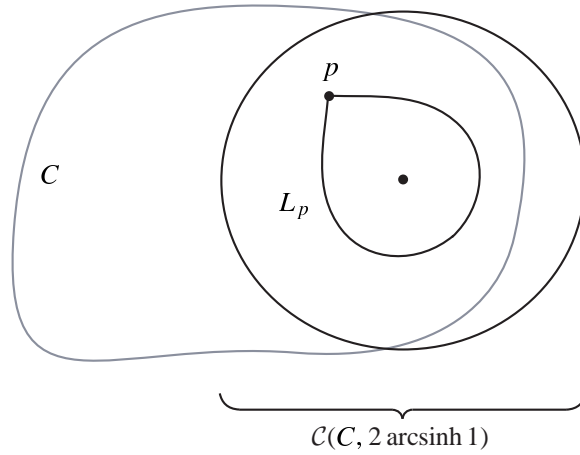

Fig. 2. The cusp around a puncture of  $R$ .

$\mathcal{C}(C, 2 \operatorname{arcsinh} 1)$  is conformally equivalent to an annulus.

By the Shimizu-Leutbecher lemma (cf. II.C.5 of Maskit [12]), we have the following assertion (see Fig. 2).

**Lemma 4.** *Let  $R$  be a hyperbolic Riemann surface of analytically finite type, and  $C$  a non-trivial closed curve on  $R$  which can be continuously deformed into a puncture of  $R$ .*

*Then, for any real number  $r$  with  $0 < r \leq 2 \operatorname{arcsinh} 1$ , the set  $\mathcal{C}(C, r)$  is conformally equivalent to a once-punctured disk.*

For a non-trivial simple closed curve  $C$  which can be continuously deformed into a puncture  $p$  of  $R$ , the set  $\mathcal{C}(C, 2 \operatorname{arcsinh} 1)$  is called a *cusp* around  $p$ .

### 3. Canonical isotopies

**3.1.** Let  $[\omega]$  be a non-trivial element of  $\operatorname{Isot}(S, 2)$ . For any quasiconformal map  $f$  on  $\dot{S}$  onto another Riemann surface, Teichmüller's existence and uniqueness theorem for extremal quasiconformal maps implies that there exists a unique quasiconformal self-map  $\omega_f$  of  $f(\dot{S})$  such that  $\omega_f$  is isotopic to  $f \circ \omega^{-1} \circ f^{-1}$  on  $f(\dot{S})$  and is extremal on  $f(\dot{S})$ , i.e.,  $\omega_f$  minimizes the dilatation among all quasiconformal self-maps on  $f(\dot{S})$ .

isotopic to  $f \circ \omega^{-1} \circ f^{-1}$  (cf. Gardiner [6], Theorem 2 and Theorem 3, pp. 119–120).

$$\begin{array}{ccc}
 \dot{S} & \xrightarrow{\omega|_S} & \dot{S} \\
 f \downarrow & & \downarrow f \\
 f(\dot{S}) & \xleftarrow{\omega_f} & f(\dot{S})
 \end{array}$$

It is well-known that every quasiconformal map  $f$  on  $\dot{S}$  is extended to a quasiconformal map  $\hat{f}$  on  $S$ . Because  $\omega$  is isotopic to id on  $S$ , the automorphism  $\widehat{\omega}_f$  is isotopic to id on  $\hat{f}(S)$ . For simplicity, we denote  $[\dot{S}, f, f(\dot{S})] \in T(\dot{S})$  by  $[f]$ . Note that  $a(\langle \omega|_S \rangle) = \inf\{\log K(\omega_f) \mid [f] \in T(\dot{S})\}$ .

In order to study the relation between  $K(\omega_f)$  and  $f(b_\omega) = (f \circ s_{\omega,1}, f \circ s_{\omega,2})$ , in the next subsection we will construct an isotopy  $h: \hat{f}(S) \times I \rightarrow \hat{f}(S)$  between id and  $\widehat{\omega}_f$  on  $\hat{f}(S)$  such that

- (1) the pure braid  $[f(b_\omega)]$  on  $\hat{f}(S)$  is induced by the homotopy  $h$ , i.e.,  $[f(b_\omega)] = [(h(\hat{f}(p_1), \cdot), h(\hat{f}(p_2), \cdot)))]$ ,
- (2) the map  $h(\cdot, t): \hat{f}(S) \rightarrow \hat{f}(S)$  is a quasiconformal map for every  $t$ , and
- (3) the maximal dilatation  $K_t$  of  $h(\cdot, t)$  is bounded by a constant depending only on  $d = d_{T(\dot{S})}([f], \langle \omega|_S \rangle([f]))$ .

**3.2.** Let  $I \ni t \mapsto [f_t] \in T(\dot{S})$  be a geodesic curve connecting  $[f]$  and  $\langle \omega|_S \rangle([f])$  with respect to the Teichmüller distance. Denote by  $\widehat{w}_t$  the extremal quasiconformal map of  $\hat{f}(S)$  onto  $\widehat{f}_t(S)$  isotopic to  $\widehat{f}_t \circ \hat{f}^{-1}$  on  $\hat{f}(S)$ .

$$\begin{array}{ccc}
 S & & \\
 \hat{f} \downarrow & \searrow \hat{f}_t & \\
 \hat{f}(S) & \xrightarrow{\widehat{w}_t} & \widehat{f}_t(S)
 \end{array}$$

We set  $v_t = \widehat{w}_t^{-1} \circ \widehat{f}_t \circ \hat{f}^{-1}|_{f(S)}$ , and let  $g_t$  be the extremal quasiconformal map of  $f(\dot{S})$  onto  $v_t(f(\dot{S}))$  isotopic to  $v_t$  on  $f(\dot{S})$ .

$$\begin{array}{ccc}
 \dot{S} & \xrightarrow{f_t} & f_t(\dot{S}) \\
 f \downarrow & & \uparrow \widehat{w}_t|_{v_t(f(S))} \\
 f(\dot{S}) & \xrightarrow{g_t} & v_t(f(\dot{S}))
 \end{array}$$

Define a map  $H_{\omega,f}: \hat{f}(S) \times I \rightarrow \hat{f}(S)$  by

$$H_{\omega,f}(z, t) = \widehat{g}_t(z) \quad (z \in \hat{f}(S), t \in I).$$



Then we have the following assertion (cf. Earle and McMullen [5]).

**Lemma 5.** *Let  $H_{\omega,f}(\cdot, t)$  ( $t \in I$ ) be a family of quasiconformal self-maps of  $\hat{f}(S)$  constructed as above. Then  $H_{\omega,f}$  is an isotopy between  $\text{id}$  and  $\widehat{\omega}_f$  on  $\hat{f}(S)$ , and it is uniquely determined by the isotopy classes of  $f$  and  $\omega|_S$  up to parameters. Moreover, for each  $t \in I$ , the maximal dilatation  $K_t$  of the quasiconformal map  $H_{\omega,f}(\cdot, t)$  satisfies*

$$(3.1) \quad K_t \leq \exp(2d_{T(\hat{S})}([f], \langle \omega|_S \rangle([f])))$$

In this paper, we call  $H_{\omega,f}$  the *canonical isotopy* between  $\text{id}$  and  $\widehat{\omega}_f$  on  $\hat{f}(S)$ .

**3.3.** Let us give a proof of Lemma 5. First we prove that the map  $H_{\omega,f}$  is uniquely determined by the isotopy classes of  $f$  and  $\omega|_S$  up to parameters. Let  $f'$  be an arbitrary quasiconformal map of  $\hat{S}$  onto  $f(\hat{S})$  isotopic to  $f$ , and  $\omega'$  an arbitrary self-homeomorphism of  $S$  fixing  $p_1, p_2$  such that  $\omega'|_S$  is isotopic to  $\omega|_S$ . Then there exists a geodesic curve  $I \ni t \mapsto [f'_t] \in T(\hat{S})$  with respect to the Teichmüller distance connecting  $[f'] = [f]$  and  $\langle \omega'|_S \rangle([f']) = \langle \omega|_S \rangle([f])$  on  $T(\hat{S})$ . We have  $[f'_t] = [f_t]$  ( $t \in I$ ) for a suitable parametrization (see Section 7.4 of Gardiner and Lakic [7]).

Fix a number  $t \in I$ . Then there is a conformal map  $\sigma$  of  $f_t(\hat{S})$  onto  $f'_t(\hat{S})$  such that  $\sigma$  is isotopic to  $f'_t \circ (f_t)^{-1}$  on  $f_t(\hat{S})$ . Denote by  $\omega'_{f'}$  the extremal quasiconformal self-map of  $f(\hat{S})$  isotopic to  $f' \circ \omega'^{-1} \circ f'^{-1}$  on  $f(\hat{S})$ . By Teichmüller's uniqueness theorem, we obtain  $\omega'_{f'} = \omega_f$ . Let  $\widehat{w}'_t: \hat{f}(S) \rightarrow \hat{f}'(S)$  be the extremal quasiconformal map isotopic to  $\widehat{f}'_t \circ \widehat{f}_t^{-1}$  on  $\hat{f}(S)$ . Since

$$\widehat{w}'_t \sim \widehat{f}'_t \circ \widehat{f}_t^{-1} \sim \widehat{\sigma} \circ \widehat{f}_t \circ \widehat{f}_t^{-1} \sim \widehat{\sigma} \circ \widehat{w}_t \quad \text{on } \hat{f}(S),$$

we have  $\widehat{w}'_t = \widehat{\sigma} \circ \widehat{w}_t$  by Teichmüller's uniqueness theorem. Set  $v'_t = \widehat{w}'_t^{-1} \circ \widehat{f}'_t \circ \widehat{f}_t^{-1}|_{f(\hat{S})}$ , and let  $g'_t$  denote the extremal quasiconformal map of  $f(\hat{S})$  onto  $v'_t(f(\hat{S}))$  isotopic to  $v'_t$  on  $f(\hat{S})$ . Then we obtain

$$\begin{aligned} g'_t &\sim \widehat{w}'_t^{-1} \circ \widehat{f}'_t \circ \widehat{f}_t^{-1}|_{f(\hat{S})} \\ &\sim (\widehat{w}_t^{-1} \circ \widehat{\sigma}^{-1}) \circ (\widehat{\sigma} \circ \widehat{f}_t) \circ \widehat{f}_t^{-1}|_{f(\hat{S})} \\ &\sim \widehat{w}_t^{-1} \circ \widehat{f}_t \circ \widehat{f}_t^{-1}|_{f(\hat{S})} \sim g_t \quad \text{on } f(\hat{S}), \end{aligned}$$

and Teichmüller's uniqueness theorem yields  $\widehat{g}'_t = \widehat{g}_t$  for any  $t \in I$ .

By taking  $f_0 = f$  and  $f_1 = f \circ \omega^{-1}$ , we have  $H_{\omega,f}(\cdot, 0) = \widehat{g}_0 = \text{id}$  and  $H_{\omega,f}(\cdot, 1) = \widehat{g}_1 = \widehat{\omega}_f$ .

Next we prove inequality (3.1). Since  $I \ni t \mapsto [f_t] \in T(\hat{S})$  is the unique geodesic

curve connecting  $[f]$  and  $\langle \omega|_S \rangle([f])$ , we have

$$K(\widehat{w}_t) \leq K(\widehat{f}_t \circ \widehat{f}^{-1}) \leq \exp(d_{T(\dot{S})}([f], \langle \omega|_S \rangle([f])))$$

for any  $t \in I$ . Hence the maximal dilatation  $K_t$  of  $H_{\omega, f}(\cdot, t)$  satisfies (3.1).

In order to prove that  $H_{\omega, f}: \widehat{f}(S) \times I \rightarrow \widehat{f}(S)$  is continuous, we may assume that  $f = \text{id}$  by changing of base points of Teichmüller spaces. Let us recall the following Teichmüller's theorem: For any hyperbolic Riemann surface  $R$  of analytically finite type, let  $A_2(R)_1$  be the set of all holomorphic quadratic differentials  $\phi$  satisfying  $\|\phi\|_1 = \int_R |\phi(z)| dx dy < 1$ . For each element  $\phi$  of  $A_2(R)_1$ , define the Beltrami differential  $\mu_\phi$  on  $R$  by

$$\mu_\phi = \|\phi\|_1 \frac{\overline{\phi}}{|\phi|}$$

for  $\phi \not\equiv 0$ , and  $\mu_\phi = 0$  for  $\phi \equiv 0$ . Let  $f_\phi: R \rightarrow f_\phi(R)$  be a quasiconformal map with Beltrami coefficient  $\mu_\phi$ , which is called the Teichmüller map associated with  $\phi$ . Then Teichmüller's theorem asserts that the map

$$\Phi_R: A_2(R)_1 \ni \phi \mapsto [f_\phi] \in T(R)$$

is a homeomorphism (cf. Gardiner [6], Theorem 8, p. 126).

If  $[\omega] \in \text{Isot}(S, 2)$  is trivial, then  $H_{\omega, \text{id}}(\cdot, t) = \text{id}$  for any  $t \in I$ . So it is sufficient to consider the case where  $[\omega] \in \text{Isot}(S, 2)$  is non-trivial. In this case, the quadratic differential  $\phi = \Phi_S^{-1}([\omega^{-1}])$  is not identically zero. For any  $t \in I$ , let  $f_t: \dot{S} \rightarrow f_t(\dot{S})$  be the quasiconformal map with Beltrami coefficient

$$\mu_t = t \|\phi\|_1 \frac{\overline{\phi}}{|\phi|}.$$

Then  $I \ni t \mapsto [f_t] \in T(\dot{S})$  is the Teichmüller geodesic from  $[\text{id}]$  to  $\langle \omega|_S \rangle([\text{id}])$ .

In order to prove that  $H_{\omega, \text{id}}$  is continuous at  $(p_0, t_0)$ , we take an arbitrary sequence  $\{t_j\}_{j=1}^\infty \subset I$  converging to  $t_0 \in I$ , and prove that the sequence of the maps  $\{H_{\omega, \text{id}}(\cdot, t_j)\}_{j=1}^\infty$  converges to  $H_{\omega, \text{id}}(\cdot, t_0)$  uniformly on every compact subset of  $S$ . The proof consists of three steps as follows.

STEP 1. First we prove that  $\widehat{f}_{t_j}$  converges to  $\widehat{f}_{t_0}$  uniformly on every compact set. For simplicity, we denote  $f_{t_j}, \mu_{t_j}$  by  $f_j, \mu_j$  respectively. Let  $\pi_S: \mathbf{H} \rightarrow S$  be a universal covering. For each  $j$ , take a universal covering  $\pi_j: \mathbf{H} \rightarrow \widehat{f}_j(S)$  and a map  $\widetilde{f}_j: \mathbf{H} \rightarrow \mathbf{H}$  so that  $\widehat{f}_j \circ \pi_j = \pi_j \circ \widetilde{f}_j$  and the continuous extension of  $\widetilde{f}_j$  to  $\overline{\mathbf{H}}$  fixes the points  $0, 1, \infty$ . We shall use the same symbol for a quasiconformal self-map of  $\mathbf{H}$  and its continuous extension to  $\overline{\mathbf{H}}$ . Denote by  $\widetilde{\mu}_j$  the Beltrami coefficient of  $\widetilde{f}_j$ .

Since the sequence  $\{\widetilde{\mu}_j\}_{j=1}^\infty$  converges to  $\widetilde{\mu}_0$  almost everywhere in  $\mathbf{H}$ , the sequence  $\{\widetilde{f}_j\}_{j=1}^\infty$  converges to  $\widetilde{f}_0$  uniformly on every compact subset of  $\mathbf{H}$  (cf. Gardiner [6], Lemma 5, p. 21).

STEP 2. Next we prove that the sequence of the inverse maps  $\{\widehat{w}_{t_j}^{-1}\}_{j=1}^\infty$  converges to  $\widehat{w}_0^{-1}$  uniformly on every compact set. We set  $\widehat{w}_j = \widehat{w}_{t_j}$ , for short.

Since the map  $t \mapsto [f_t] \in T(\widehat{S})$  and the forgetful map of  $T(\widehat{S})$  onto  $T(S)$  are continuous, the sequence  $\{[\widehat{w}_j]\}_{j=1}^\infty \subset T(S)$  converges to  $[\widehat{w}_0] \in T(S)$ . For any  $j$ , we set  $\psi_j = \Phi_S^{-1}([\widehat{w}_j]) \in A_2(S)_1$ . By Teichmüller’s uniqueness theorem,

$$\nu_j = \begin{cases} \|\psi_j\|_1 \frac{\overline{\psi_j}}{|\psi_j|} & (\text{if } \psi_j \not\equiv 0) \\ 0 & (\text{if } \psi_j \equiv 0) \end{cases}$$

is the Beltrami coefficient of  $\widehat{w}_j$ . Since  $\widehat{w}_j$  is isotopic to  $\widehat{f}_j$  on  $S$ , we can take a map  $\widetilde{w}_j: \mathbf{H} \rightarrow \mathbf{H}$  so that  $\widehat{w}_j \circ \pi_S = \pi_j \circ \widetilde{w}_j$  on  $\mathbf{H}$  and  $\widetilde{w}_j = f_j$  on the real axis. Then  $\widetilde{w}_j$  fixes  $0, 1, \infty$ . Let  $\widetilde{\nu}_j$  be the Beltrami coefficient of  $\widetilde{w}_j$ . If  $\psi_0 \equiv 0$ , then the sequence of norms  $\{\|\widetilde{\nu}_j\|_\infty\}_{j=1}^\infty$  converges to zero. In the case of  $\psi_0 \not\equiv 0$ , the sequence  $\{\widetilde{\nu}_j\}_{j=1}^\infty$  converges pointwise to  $\widetilde{\nu}_0$  on  $\mathbf{H} \setminus \{z \in \mathbf{H} \mid \psi_0(\pi_S(z)) = 0, \text{ or } \pi_S(z) = p_k (k = 1, 2)\}$ , because each  $\psi_j$  is holomorphic and  $\|\psi_0 - \psi_j\|_1 \rightarrow 0$  as  $j \rightarrow \infty$ . Hence, in both cases, the sequence  $\{\widetilde{\nu}_j\}_{j=1}^\infty$  converges to  $\widetilde{\nu}_0$  almost everywhere in  $\mathbf{H}$ . It follows that the sequence  $\{\widehat{w}_j\}_{j=1}^\infty$  converges to  $\widehat{w}_0$  uniformly on every compact subset of  $\mathbf{H}$  (cf. Gardiner [6], Lemma 5, p. 21).

Let us see the convergence of the sequence  $\{\widehat{w}_j^{-1}\}_{j=1}^\infty$ . If  $\psi_0 \equiv 0$ , then the map  $\widehat{w}_0^{-1}$  is the identity, and the Beltrami coefficients  $\nu'_j$  of the maps  $\widehat{w}_j^{-1}$  satisfy  $\|\nu'_j\|_\infty = \|\widetilde{\nu}_j\|_\infty \rightarrow 0$  as  $j \rightarrow \infty$ . In the case of  $\psi_0 \not\equiv 0$ , we may assume that  $\psi_j \not\equiv 0$  for each  $j$ . Since  $\psi_j$  is holomorphic, the Beltrami coefficient  $\widetilde{\nu}_j$  of  $\widetilde{w}_j$  is real analytic on  $\mathbf{H} \setminus \{z \in \mathbf{H} \mid \psi_j(\pi_S(z)) = 0\}$ . Hence  $\widetilde{w}_j$  is real analytic on  $\mathbf{H} \setminus \{z \in \mathbf{H} \mid \psi_j(\pi_S(z)) = 0\}$ , and the partial derivatives  $\partial \widetilde{w}_j, \bar{\partial} \widetilde{w}_j$  converge uniformly to  $\partial \widetilde{w}_0, \bar{\partial} \widetilde{w}_0$  respectively on every compact subset of  $\mathbf{H} \setminus \{z \in \mathbf{H} \mid \psi_0(\pi_S(z)) = 0\}$ . It follows that the Beltrami coefficients

$$\widetilde{\nu}'_j(\zeta) = -\widetilde{\nu}_j(z) \times \left( \frac{\partial \widetilde{w}_j(z)}{|\partial \widetilde{w}_j(z)|} \right)^2, \quad \zeta = \widetilde{w}_j(z)$$

of the inverse maps  $\widehat{w}_j^{-1}$  converge to the Beltrami coefficient

$$\widetilde{\nu}'_0(\zeta) = -\widetilde{\nu}_0(z) \times \left( \frac{\partial \widetilde{w}_0(z)}{|\partial \widetilde{w}_0(z)|} \right)^2, \quad \zeta = \widetilde{w}_j(z)$$

of  $\widehat{w}_0^{-1}$  pointwise almost everywhere. Thus the sequence of maps  $\{\widehat{w}_j^{-1}\}_{j=1}^\infty$  converges to  $\widehat{w}_0^{-1}$  uniformly on every compact subset of  $\mathbf{H}$  in both cases.

STEP 3. Last we verify that  $\widehat{g}_j = H_{\omega, \text{id}}(\cdot, t_j)$  converges to  $\widehat{g}_0 = H_{\omega, \text{id}}(\cdot, t_0)$  uniformly on every compact subset of  $S$ .

Each  $\widehat{g}_j$  is a quasiconformal self-map isotopic to  $\text{id}$  on  $S$ , and  $\widehat{g}_j|_S$  is a

Teichmüller map satisfying

$$[\widehat{g}_j|_S] = [\widehat{w}_j^{-1} \circ \widehat{f}_j|_S] \in T(\widehat{S}).$$

By the results of Step 1 and Step 2, the maps  $\widehat{w}_j^{-1} \circ \widehat{f}_j: S \rightarrow S$  converges to the map  $\widehat{w}_0^{-1} \circ \widehat{f}_0$  uniformly on every compact subset of  $S$ . It follows that the sequence  $\{[\widehat{g}_j|_S]\}_{j=1}^\infty \subset T(\widehat{S})$  converges to  $[\widehat{g}_0|_S]$ . Hence, by an argument similar to that in Step 2, we see that the sequence  $\{\widehat{g}_j\}_{j=1}^\infty$  converges to  $\widehat{g}_0$  uniformly on every compact subset of  $S$ . □

**3.4.** Next we see a property of the canonical isotopy. Define a function  $\lambda_0: [0, \infty) \times (0, \infty) \rightarrow \mathbf{R}$  by

$$\lambda_0(d, l) = 2 \operatorname{arctanh} \left( \mu^{-1} \left( \frac{\mu(\tanh(l/2))}{\exp(4d)} \right) \right),$$

where  $\mu(r)$  is the modulus of Grötzsch’s ring domain  $\{z \in \mathbf{C} \mid |z| < 1\} \setminus [0, r]$ . The function  $\lambda_0$  is a continuous function which is strictly increasing with respect to the first and the second parameters. The function  $\lambda_0$  also satisfies

$$(3.2) \quad \lambda_0(d_0, l_0) \geq l_0 \quad \text{and} \quad \lim_{l \rightarrow 0} \lambda_0(d_0, l) = 0$$

for any  $d_0 \geq 0, l_0 > 0$ . In view of Lemma 5 and a distortion theorem of quasiconformal maps, we get the following.

**Lemma 6.** *Let  $[\omega]$  be an arbitrary element of  $\operatorname{Isot}(S, 2)$ , and  $[f]$  an arbitrary point of  $T(\widehat{S})$ . Denote by  $H_{\omega, f}$  the canonical isotopy between  $\operatorname{id}$  and  $\widehat{\omega}_f$  on  $\widehat{f}(S)$ . Take a curve  $L$  connecting two points  $a_1, a_2$  on  $\widehat{f}(S)$ . For each  $t \in I$ , let  $L_t$  be a unique geodesic curve in the homotopy class of  $H_{\omega, f}(L, t)$  rel  $H_{\omega, f}(a_1, t)$  and  $H_{\omega, f}(a_2, t)$ .*

*Then for any  $t, t' \in I$ ,*

$$l_{\widehat{f}(S)}(L_t) \leq \lambda_0(d_{T(S)}([f], \langle \omega|_S \rangle([f])), l_{\widehat{f}(S)}(L_{t'})).$$

**Proof.** Set

$$\begin{aligned} d_0 &= d_{T(S)}([f], \langle \omega|_S \rangle([f])), \\ w &= H_{\omega, f}(\cdot, t) \circ \{H_{\omega, f}(\cdot, t')\}^{-1}. \end{aligned}$$

Lemma 1 and (3.1) of Lemma 5 together yield

$$\frac{\mu(r')}{\mu(r)} \leq K(w) \leq \exp(4d_0),$$

where  $r = \tanh(l_{\hat{f}(S)}(L_r)/2)$  and  $r' = \tanh(l_{\hat{f}(S)}(L_{r'})/2)$ . Hence we have  $l_{\hat{f}(S)}(L_r) \leq \lambda_0(d_0, l_{\hat{f}(S)}(L_{r'}))$ . □

**4. Proof of Main Theorem**

**4.1.** A proof of main theorem will be given in a series of propositions as follows.

**Proposition 1.** *For any non-trivial element  $[\omega] \in \text{Isot}(S, 2)$ , the element  $\langle \omega|_{\hat{S}} \rangle \in \text{Mod}(\hat{S})$  is not elliptic.*

*Proof.* Since the correspondence  $\text{Isot}(S, 2) \ni [\omega] \mapsto \langle \omega|_{\hat{S}} \rangle \in \text{Mod}(\hat{S})$  is injective, it is sufficient to show that the group  $\text{Isot}(S, 2)$  is a torsion-free group.

Let  $[\omega]$  be an element of  $\text{Isot}(S, 2)$ . Assume that there exists a number  $n_0 \geq 1$  such that  $(\omega|_{\hat{S}})^{n_0}$  is isotopic to the identity on  $\hat{S}$ . Since  $(\omega|_{S \setminus \{p_1\}})^{n_0}$  is isotopic to the identity on  $S \setminus \{p_1\}$  and the group  $\text{Isot}(S, \{p_1\})$  is isomorphic to the torsion-free group  $\pi_1(S, p_1)$ , it follows that  $\omega|_{S \setminus \{p_1\}}$  is isotopic to the identity on  $S \setminus \{p_1\}$  (cf. Proposition 1 of Kra [10]). Because  $\text{Isot}(S \setminus \{p_1\}, \{p_2\})$  is isomorphic to the torsion-free group  $\pi_1(S \setminus \{p_1\}, p_2)$ , the element  $[\omega] \in \text{Isot}(S \setminus \{p_1\}, \{p_2\})$  is trivial, and the map  $\omega|_{\hat{S}}$  is isotopic to the identity on  $\hat{S}$ . Hence  $\text{Isot}(S, 2)$  is torsion-free. □

**REMARK.** From a referee we learned a simple proof of Proposition 1: If  $\langle \omega|_{\hat{S}} \rangle$  is elliptic, it has a fixed point  $[f_0]$  in  $T(\hat{S})$ . Set  $\hat{S}_0 = f_0(\hat{S})$  and  $S_0 = \widehat{f_0}(S)$ . Then the map  $f_0 \circ \omega|_{\hat{S}} \circ f_0^{-1} : \hat{S}_0 \rightarrow \hat{S}_0$  is isotopic to some conformal self-map  $\sigma : \hat{S}_0 \rightarrow \hat{S}_0$ . Since the map  $\widehat{f_0} \circ \omega \circ \widehat{f_0}^{-1} : S_0 \rightarrow S_0$  is isotopic to the identity, we have  $\widehat{\sigma} = \text{id}$  and conclude that  $\omega|_{\hat{S}}$  is isotopic to the identity on  $\hat{S}_0$ . This contradicts to the assumption of Proposition 1.

**4.2.** Next we state the following topological assertions.

**Lemma 7.** *Let  $[\omega]$  be an element of  $\text{Isot}(S, 2)$ , and  $[b_\omega]$  ( $b_\omega = (s_1, s_2)$ ) the pure braid induced by  $\omega$ . If  $s_1$  is parallel to  $s_2$ , then for any  $r > 0$  there exists a self-homeomorphism  $w$  of  $S$  with  $w(p_2) = p_2$  such that the element  $[b_{w \circ \omega \circ w^{-1}}]$  of the pure braid group of  $S$  with base point  $(w(p_1), p_2)$  has a representative  $(s'_1, s_2)$  satisfying  $d_S(s'_1(t), s_2(t)) < r$  for all  $t \in I$ .*

*Proof.* Since  $s_1$  is parallel to  $s_2$ , there exists a continuous map  $F : I \times I \rightarrow S$  such that

- (i)  $F(t_1, t_2) \neq s_2(t_1)$  for any  $t_1 \in I, t_2 \in [0, 1)$ ,
- (ii)  $F(\cdot, 0) = s_1(\cdot), F(\cdot, 1) = s_2(\cdot)$ , and
- (iii)  $F(0, \cdot) = F(1, \cdot)$ .

Take a number  $x_0 \in I$  so that

$$d_S(F(t_1, t_2), s_2(t_1)) < r \quad \text{for } t_1 \in I, \ t_2 \in [x_0, 1].$$

Set

$$\begin{aligned} p'_1 &= F(0, x_0), \\ s'_1(t) &= F(t, x_0), \\ \dot{S}' &= S \setminus \{p'_1, p_2\}. \end{aligned}$$

Then there exists a homeomorphism  $\omega' : S \rightarrow S$  isotopic to the identity of  $S$  and there exists an isotopy  $h_{\omega'} : S \times I \rightarrow S$  such that

- (1)  $h_{\omega'}(\cdot, 0) = \text{id}$  and  $h_{\omega'}(\cdot, 1) = \omega'(\cdot)$ , and
- (2)  $h_{\omega'}(p'_1, t) = s'_1(t)$  and  $h_{\omega'}(p_2, t) = s_2(t)$  for all  $t \in I$ .

The element  $[(s'_1, s_2)] \in \pi_1(M \setminus \Delta, (p'_1, p_2))$  is the pure braid induced from  $[\omega'] \in \text{Isot}(S, \{p'_1, p_2\})$ .

On the other hand, we can construct a homeomorphism  $w : S \rightarrow S$  isotopic to the identity on  $S$  and the isotopy  $h_w : S \times I \rightarrow S$  such that

- (1)  $h_w(\cdot, 0) = \text{id}$  and  $h_w(\cdot, 1) = w(\cdot)$ , and
- (2)  $h_w(p_1, t) = F(0, x_0t)$  and  $h_w(p_2, t) = p_2$  for all  $t \in I$ .

The map  $w$  satisfies  $w(p_1) = p'_1$ . Set  $\omega'' = w \circ \omega \circ w^{-1}$ . We shall show that  $(s'_1, s_2)$  is a representative of the pure braid induced from  $[\omega''] \in \text{Isot}(S, \{p'_1, p_2\})$ . Define an isotopy  $h_{\omega''} : S \times I \rightarrow S$  from  $\text{id}$  to  $\omega''$  by

$$h_{\omega''}(p, t) = \begin{cases} h_w(w^{-1}(p), 1 - 3t) & \left(0 \leq t < \frac{1}{3}, p \in S\right) \\ h_w(w^{-1}(p), 3t - 1) & \left(\frac{1}{3} \leq t < \frac{2}{3}, p \in S\right) \\ h_w(\omega \circ w^{-1}(p), 3t - 2) & \left(\frac{2}{3} \leq t \leq 1, p \in S\right). \end{cases}$$

We set  $s''_1(t) = h_{\omega''}(p'_1, t)$  for all  $t \in I$ . Then  $[(s''_1, s_2)] \in \pi_1(M \setminus \Delta, (p'_1, p_2))$  is the pure braid induced from  $[\omega''] \in \text{Isot}(S, \{p'_1, p_2\})$ . The closed path  $I \ni t \mapsto (s'_1(t), s_2(t)) \in M \setminus \Delta$  is homotopic rel  $(p'_1, p_2)$  to the closed path  $I \ni t \mapsto (s''_1(t), s_2(t)) \in M \setminus \Delta$  on  $M \setminus \Delta$  by the homotopy

$$I \times I \ni (t, u) \mapsto \begin{cases} (F(0, x_0(1 - 3t)), s_2(t)) & \left(0 \leq t \leq \frac{u}{3}\right) \\ \left(F\left(\frac{t - u/3}{1 - 2u/3}, x_0(1 - u)\right), s_2(t)\right) & \left(\frac{u}{3} \leq t \leq 1 - \frac{u}{3}\right) \\ (F(1, x_0(3t - 2)), s_2(t)) & \left(1 - \frac{u}{3} \leq t \leq 1\right). \end{cases}$$

This yields  $[(s'_1, s_2)] = [(s''_1, s_2)]$ . □

**Lemma 8.** *Let  $[\omega]$  be an element of  $\text{Isot}(S, 2)$ , and  $[b_\omega]$  ( $b_\omega = (s_1, s_2)$ ) be the pure braid induced from  $\omega$ .*

- (1)  $s_1$  is parallel to  $s_2$  if and only if there exists a simple closed curve  $C$  on  $\dot{S}$  such that (1a)  $C$  is the boundary curve of a topological open disk  $D$  of  $S$  with  $p_1, p_2 \in D$ , and (1b)  $\omega(C)$  is freely homotopic to  $C$  on  $\dot{S}$ .
- (2)  $s_j$  is parallel to a puncture  $p$  of  $S$  if and only if there exists a simple closed curve  $C$  on  $\dot{S}$  such that (2a)  $C$  is the boundary curve of a topological open disk  $D$  of  $\dot{S} \cup \{p_j, p\}$  with  $p_j, p \in D$ , and (2b)  $\omega(C)$  is freely homotopic to  $C$  on  $\dot{S}$ .

*Proof.* We will give a proof of statement (1). We may assume that the map  $\omega|_{\dot{S}}: \dot{S} \rightarrow \dot{S}$  is a Teichmüller map. Then, by the same construction as one in Step 3 of Lemma 5, we find an isotopy  $h_\omega: S \times I \rightarrow S$  from  $\text{id}$  to  $\omega$  such that

- (1)  $h_\omega(p_j, \cdot) = s_j(\cdot)$  for  $j = 1, 2$ , and
- (2) the map  $h_\omega(\cdot, t)|_{\dot{S}}: \dot{S} \rightarrow S \setminus \{s_1(t), s_2(t)\}$  is a Teichmüller map for every  $t \in I$ .

Note that since  $h_\omega(\cdot, t)|_{\dot{S}}$  is a Teichmüller map for every  $t \in I$ , the same argument as one in the proof of Lemma 5 yields that the map  $S \times I \ni (p, t) \mapsto (h_\omega(\cdot, t))^{-1}(p) \in S$  is also continuous.

Assume that there exists a simple closed curve  $C$  on  $\dot{S}$  satisfying (1a) and (1b). Take a simple curve  $\alpha$  on  $D$  such that  $\alpha(0) = p_1$  and  $\alpha(1) = p_2$ , and set  $F_\omega(t_1, t_2) = h_\omega(\alpha(t_2), t_1)$  for any  $t_1, t_2 \in I$ . Then  $F_\omega(t_1, 0) = h_\omega(p_1, t_1) = s_1(t_1)$  and  $F_\omega(t_1, 1) = h_\omega(p_2, t_1) = s_2(t_1)$  for any  $t_1 \in I$ . Since  $\alpha$  is simple, we obtain  $F_\omega(t_1, t_2) \neq s_2(t_1)$  for any  $t_1 \in I$  and  $t_2 \in [0, 1)$ .

Because  $\omega(C)$  is freely homotopic to  $C$  on  $\dot{S}$ , there exists a homeomorphism  $w: S \rightarrow S$  isotopic to the identity of  $S$  and there exists an isotopy  $h_w: S \times I \rightarrow S$  such that

- (1)  $h_w(\cdot, 0) = \text{id}$ ,  $h_w(\cdot, 1) = w(\cdot)$ ,
- (2)  $h_w(p_1, t) = p_1$ ,  $h_w(p_2, t) = p_2$  for all  $t \in I$ , and
- (3)  $w(C) = C$ .

This follows from Baer-Zieschang theorem (A.3 of Buser [4]). We set  $F_w(t_1, t_2) = h_w(\omega(\alpha(t_2)), t_1)$  for any  $t_1, t_2 \in I$ .

Since the curves  $\alpha$  and  $F_w(1, \cdot) = w \circ \omega(\alpha)$  are simple and are contained in the disk  $D$ , we can easily construct a continuous map  $F_\alpha: I \times I \rightarrow S$  such that

- (1)  $F_\alpha(0, \cdot) = F_w(1, \cdot)$ ,  $F_\alpha(1, \cdot) = \alpha(\cdot)$ ,
- (2)  $F_\alpha(t_1, 0) = p_1$ ,  $F_\alpha(t_1, 1) = p_2$  for all  $t_1 \in I$ , and
- (3)  $F_\alpha(t_1, t_2) \neq p_2$  for any  $t_1 \in I$ ,  $t_2 \in [0, 1)$ .

Finally we define a continuous map  $F: I \times I \rightarrow S$  by

$$F(t_1, t_2) = \begin{cases} F_\omega(3t_1, t_2) & \left(0 \leq t_1 < \frac{1}{3}, t_2 \in I\right) \\ F_w(3t_1 - 1, t_2) & \left(\frac{1}{3} \leq t_1 < \frac{2}{3}, t_2 \in I\right) \\ F_\alpha(3t_1 - 2, t_2) & \left(\frac{2}{3} \leq t_1 \leq 1, t_2 \in I\right). \end{cases}$$

Set  $s'_1(t) = F(t, 0)$  and  $s'_2(t) = F(t, 1)$ . Then  $(s'_1, s'_2) \in [(s_1, s_2)]$ , and  $s'_1$  is parallel to  $s'_2$  by  $F$ . Thus, we conclude that  $s_1$  is parallel to  $s_2$ .

Conversely, assume that  $s_1$  is parallel to  $s_2$ . Set  $r_0 = \min\{r_{\text{inj}}(S, s_2(t)) \mid t \in I\}$ , where  $r_{\text{inj}}(S, p)$  is the injectivity radius of  $S$  at  $p \in S$ . Then, by Lemma 7, we may assume that  $d_S(s_1(t), s_2(t)) < r_0/3$  for all  $t \in I$ . Let  $C_t \subset S$  denote the circle of radius  $r_0/2$  centered at  $s_2(t)$ . Then  $C = C_0 = C_1$  is a simple closed curve on  $\hat{S}$  satisfying (1a), and  $\omega(C)$  is freely homotopic to  $C$  on  $\hat{S}$  by the homotopy  $I \ni t \mapsto \omega \circ (h_\omega(\cdot, t))^{-1}(C_t)$ . We have proved statement (1).

Statement (2) is proved similarly. □

**4.3.** As an immediate consequence of Lemma 8, we obtain the following proposition.

**Proposition 2.** *For a non-trivial element  $[\omega] \in \text{Isot}(S, 2)$ , the assumption that  $\langle \omega|_S \rangle$  is hyperbolic as an element of  $\text{Mod}(\hat{S})$  implies conditions (2a), (2b) and (2c) of Main Theorem.*

*Proof.* By Proposition 1, the element  $\langle \omega|_S \rangle$  is not elliptic. If condition (2a) of Main Theorem does not hold, then there exists an admissible simple closed curve  $C$  on  $\hat{S}$  which does not intersect  $s_1$  and  $s_2$  for some representative  $(s_1, s_2)$  of  $[b_\omega]$ . Since  $\omega(C)$  is freely homotopic to  $C$  on  $\hat{S}$ , the map  $\omega|_S$  is reducible. If condition (2b) or (2c) of Main Theorem does not hold, then by Lemma 8, the map  $\omega|_S$  is reducible. Hence, by Theorem 7 of Bers [1], the element  $\langle \omega|_S \rangle$  is not hyperbolic. □

**4.4.** Let  $[\omega]$  be an element of  $\text{Isot}(S, 2)$ , and  $[f]$  an arbitrary point of  $T(\hat{S})$ . Denote by  $\omega_f$  the extremal quasiconformal self-map of  $f(\hat{S})$  isotopic to  $f \circ \omega^{-1} \circ f^{-1}$  on  $f(\hat{S})$ . Let  $H_{\omega, f}: \hat{f}(S) \times I \rightarrow \hat{f}(S)$  be the canonical isotopy between  $\text{id}$  and  $\widehat{\omega}_f$ . For any  $j = 1, 2$ , we set

$$s_j^f(t) = H_{\omega, f}(\hat{f}(p_j), t) \in \hat{f}(S), \quad t \in I.$$

Then  $(s_1^f, s_2^f) \in \pi_1(M_f \setminus \Delta_f, \mathbf{p}_f)$  is a pure braid induced from  $[\widehat{\omega}_f] \in \text{Isot}(\hat{f}(S), \{\hat{f}(p_1), \hat{f}(p_2)\})$ , where  $M_f = \hat{f}(S) \times \hat{f}(S)$ ,  $\Delta_f = \{(x_1, x_2) \in M_f \mid x_1 = x_2\}$  and



$\mathbf{p}_f = (\hat{f}(p_1), \hat{f}(p_2))$ .

The following lemma is an essential tool for proving the converse of Proposition 2.

**Lemma 9.** *There exists a strictly decreasing continuous function*

$$\lambda_1: [0, \infty) \rightarrow (0, \operatorname{arcsinh} 1]$$

which has the following properties: Let  $[\omega]$  be an arbitrary non-trivial element of  $\operatorname{Isot}(S, 2)$  satisfying (2a) and (2c) of Main Theorem, and  $[f]$  an arbitrary element of  $T(S)$ . Then

$$(4.1) \quad l_{\hat{f}(S)}(L) > \lambda_1(d_0), \quad d_0 = d_{T(S)}([f], \langle \omega|_S \rangle([f]))$$

for any non-trivial closed geodesic loop  $L$  on  $\hat{f}(S)$  with base point  $p \in s_1^f(I) \cup s_2^f(I)$ .

*Proof.* For any  $d > 0$ , we set

$$(4.2) \quad \lambda_1(d) = \sup\{l > 0 \mid \operatorname{arcsinh} 1 > \lambda_0(d, \lambda_0(d, l))\}.$$

Then by (3.2), we have  $\lambda_1(d_0) \leq \sup\{l > 0 \mid \operatorname{arcsinh} 1 > \lambda_0(d_0, l)\} \leq \operatorname{arcsinh} 1$ . Let  $L$  be an arbitrary non-trivial closed geodesic loop with base point  $p \in s_1^f(I) \cup s_2^f(I)$  on  $\hat{f}(S)$ .

If  $[L] \in \pi_1(\hat{f}(S), p)$  is hyperbolic but not simple hyperbolic, then  $l_{\hat{f}(S)}(L) \geq 4 \operatorname{arcsinh} 1 > \lambda_1(d_0)$  by Lemma 7 of Yamada [15].

In the case where  $[L] \in \pi_1(\hat{f}(S), p)$  is parabolic or simple hyperbolic, we will obtain (4.1) by contradiction. Assume that

$$(4.3) \quad l_{\hat{f}(S)}(L) \leq \lambda_1(d_0).$$

It is sufficient to consider the case of  $p \in s_1^f(I)$ . Take a point  $t_1 \in I$  with  $s_1^f(t_1) = p$ , and set

$$L_0 = H_{\omega, f}(\cdot, t_1)^{-1}(L).$$

Then  $L_0$  is a closed curve on  $\hat{f}(S)$  with base point  $\hat{f}(p_1)$ , and is freely homotopic to  $L$  on  $\hat{f}(S)$ .

For any  $t \in I$ , let  $L(t)$  be a closed geodesic loop with base point  $s_1^f(t)$  on  $\hat{f}(S)$  homotopic to  $H_{\omega, f}(L_0, t)$  rel the base point. By Lemma 6, we have

$$(4.4) \quad l_{\hat{f}(S)}(L(t)) \leq \lambda_0(d_0, l_{\hat{f}(S)}(L)), \quad t \in I.$$

Thus, by (4.2), (4.3) and (4.4), we obtain

$$(4.5) \quad l_{\hat{f}(S)}(L(t)) < 2 \operatorname{arcsinh} 1, \quad t \in I.$$

This yields

$$(4.6) \quad s_1^f(t) \in \mathcal{C}(L, 2 \operatorname{arcsinh} 1) \subset \hat{f}(S), \quad t \in I.$$

If  $[L]$  is a simple hyperbolic element of  $\pi_1(\hat{f}(S), p)$ , then Lemma 3 implies that the set  $\mathcal{C}(L, 2 \operatorname{arcsinh} 1)$  is conformally equivalent to an annulus. On the other hand, if  $[L]$  is a parabolic element of  $\pi_1(\hat{f}(S), p)$ , then Lemma 4 asserts that the domain  $\mathcal{C}(L, 2 \operatorname{arcsinh} 1)$  is conformally equivalent to a punctured disk. Thus,  $s_1^f(I)$  is included in a collar or a cusp of  $\hat{f}(S)$ .

Next, we consider the string  $s_2^f$ . For any  $t \in I$ , let  $\mathcal{M}^t$  be the set of all closed geodesic loops on  $\hat{f}(S)$  with base point  $s_2^f(t)$ , and  $M^t$  an element of  $\mathcal{M}^t$  which minimizes the hyperbolic length on  $\hat{f}(S)$  among all elements of  $\mathcal{M}^t$ . By (4.6) and conditions (2a), (2c) of Main Theorem, there exist a point  $t_2 \in I$  satisfying

$$(4.7) \quad \max\{l_{\hat{f}(S)}(L(t)) \mid t \in I\} \geq l_{\hat{f}(S)}(M^{t_2}).$$

Indeed, suppose that there is no such a  $t_2$ . Set

$$r_0 = \min \left\{ 2 \operatorname{arcsinh} 1, \frac{l_0 + m_0}{2} \right\},$$

where  $l_0 = \max\{l_{\hat{f}(S)}(L(t)) \mid t \in I\}$  and  $m_0 = \min\{l_{\hat{f}(S)}(M^t) \mid t \in I\}$ . If  $[L]$  is a simple hyperbolic element of  $\pi_1(\hat{f}(S), p)$ , then the set  $\mathcal{C}(L, r_0)$  is conformally equivalent to an annulus. A boundary component  $C$  of  $\mathcal{C}(L, r_0)$  is an admissible closed curve on  $\hat{f}(S)$  satisfying  $C \cap (s_1^f(I) \cup s_2^f(I)) = \emptyset$ . Thus condition (2a) of Main Theorem does not hold. On the other hand, if  $[L]$  is a parabolic element of  $\pi_1(\hat{f}(S), p)$ , then the set  $\mathcal{C}(L, r_0)$  is conformally equivalent to a once-punctured disk. Let  $C$  be the boundary curve of  $\mathcal{C}(L, r_0)$ . Then  $C \cap (s_1^f(I) \cup s_2^f(I)) = \emptyset$  and  $\omega_f(C)$  is freely homotopic to  $C$  on  $f(S)$ . It follows from Lemma 8 that the string  $s_1$  of  $b_\omega$  is parallel to a puncture of  $S$ , and condition (2c) of Main Theorem does not hold. Hence, in both cases, we obtain a contradiction to an assumption of Lemma 9.

Set  $M_0 = H_{\omega, f}(\cdot, t_2)^{-1}(M^{t_2})$ . Then  $M_0$  is a closed curve on  $\hat{f}(S)$  with base point  $\hat{f}(p_2)$ . For any  $t \in I$ , let  $M(t)$  be a closed geodesic loop with base point  $s_2^f(t)$  homotopic to  $H_{\omega, f}(M_0, t)$  on  $\hat{f}(S)$  rel the base point. By Lemma 6, we have  $l_{\hat{f}(S)}(M(t)) \leq \lambda_0(d_0, l_{\hat{f}(S)}(M^{t_2}))$  for any  $t \in I$ . Thus, (4.3), (4.4) and (4.7) together yield

$$\begin{aligned} l_{\hat{f}(S)}(M(t)) &\leq \lambda_0(d_0, \max\{l_{\hat{f}(S)}(L(t')) \mid t' \in I\}) \\ &\leq \lambda_0(d_0, \lambda_0(d_0, l_{\hat{f}(S)}(L))) \\ &< 2 \operatorname{arcsinh} 1, \quad t \in I. \end{aligned}$$

This gives

$$(4.8) \quad s_2^f(t) \in \mathcal{C}(L, 2 \operatorname{arcsinh} 1), \quad t \in I.$$

By (4.6) and (4.8), we get the contradiction to condition (2a) of Main Theorem.  $\square$

**4.5.** Now, we state the converse of Proposition 2.

**Proposition 3.** *If a non-trivial element  $[\omega] \in \operatorname{Isot}(S, 2)$  satisfies conditions (2a), (2b) and (2c) of Main Theorem, then  $\langle \omega|_S \rangle$  is hyperbolic as an element of  $\operatorname{Mod}(\dot{S})$ .*

*Proof.* By Proposition 1, it is sufficient to find an element  $\tau_0 \in T(\dot{S})$  such that  $a(\langle \omega|_S \rangle) = d_{T(\dot{S})}(\tau_0, \langle \omega|_S \rangle(\tau_0))$ . This is done as follows.

By definition, there exists a sequence  $\{[f_j]\}_{j=1}^\infty$  in  $T(\dot{S})$  satisfying

$$a(\langle \omega|_S \rangle) = \lim_{j \rightarrow \infty} d_{T(\dot{S})}([f_j], \langle \omega|_S \rangle([f_j])).$$

We set

$$(4.9) \quad d_0 = \max\{d_{T(\dot{S})}([f_j], \langle \omega|_S \rangle([f_j])) \mid j = 1, 2, \dots\}.$$

Let  $\omega_j = \omega_{f_j}$  be the extremal quasiconformal self-map of  $f_j(\dot{S})$  isotopic to  $\widehat{f}_j \circ \omega^{-1} \circ \widehat{f}_j^{-1}|_{f_j(\dot{S})}$ . Then we have  $K(\omega_j) = \exp(d_{T(\dot{S})}([f_j], \langle \omega|_S \rangle([f_j])))$ . Denote by  $H_{\omega, f_j}$  the canonical isotopy from  $\operatorname{id}$  to  $\widehat{\omega}_j$ .

We claim the following:

**CLAIM.** There exists a positive number  $\Lambda(d_0)$  depending only on  $d_0$  such that

$$(4.10) \quad l_{f_j(\dot{S})}(L) > \Lambda(d_0)$$

for any  $j$  and any admissible simple closed geodesic  $L$  on  $f_j(\dot{S})$ .

The claim yields Proposition 3 as follows (cf. Theorem 4 of Bers [1] and Theorem 2 of Kra [10]): By the assertion of the claim and Lemma 4 of Bers [1], selecting if need be a subsequence from  $\{f_j\}_{j=1}^\infty$ , we can take a sequence  $\{\theta_j\}_{j=1}^\infty \subset \operatorname{Mod}(\dot{S})$  so that  $\tau_j = \theta_j([f_j])$  converges to a point  $\tau_\infty$  of  $T(\dot{S})$ . Set

$$\chi_j = \theta_j \circ \langle \omega|_S \rangle \circ \theta_j^{-1} \in \operatorname{Mod}(\dot{S}).$$

Then by (4.9), we have

$$d_{T(\dot{S})}(\tau_\infty, \chi_j(\tau_j)) \leq d_{T(\dot{S})}(\tau_\infty, \tau_j) + d_{T(\dot{S})}(\tau_j, \chi_j(\tau_j))$$

$$\begin{aligned}
 &= d_{T(\mathcal{S})}(\tau_\infty, \tau_j) \\
 &\quad + d_{T(\mathcal{S})}(\theta_j([f_j]), \theta_j \circ \langle \omega|_{\mathcal{S}} \rangle([f_j])) \\
 &= d_{T(\mathcal{S})}(\tau_\infty, \tau_j) + d_{T(\mathcal{S})}([f_j], \langle \omega|_{\mathcal{S}} \rangle([f_j])) \\
 &\leq d_{T(\mathcal{S})}(\tau_\infty, \tau_j) + d_0.
 \end{aligned}$$

Therefore, we may assume by taking a subsequence if necessary that the sequence  $\chi_j(\tau_j)$  converges to a point  $\tau'_\infty$  of  $T(\mathcal{S})$ . This follows from the fact that  $T(\mathcal{S})$  is of finite dimensional and is complete with respect to the Teichmüller distance  $d_{T(\mathcal{S})}$ . Hence, the triangle inequality asserts that  $\{\chi_j(\tau_\infty)\}_{j=1}^\infty$  converges to  $\tau'_\infty$ . Selecting if need be a subsequence, we can find an element  $\chi$  of  $\text{Mod}(\mathcal{S})$  and a number  $j_0$  such that  $\chi = \chi_j$  for all  $j > j_0$ , because  $\text{Mod}(\mathcal{S})$  acts properly discontinuously on  $T(\mathcal{S})$ . This yields

$$\begin{aligned}
 a(\langle \omega|_{\mathcal{S}} \rangle) &= \lim_{j \rightarrow \infty} d_{T(\mathcal{S})}([f_j], \langle \omega|_{\mathcal{S}} \rangle([f_j])) \\
 &= \lim_{j \rightarrow \infty} d_{T(\mathcal{S})}(\theta_j([f_j]), \theta_j \circ \langle \omega|_{\mathcal{S}} \rangle([f_j])) \\
 &= \lim_{j \rightarrow \infty} d_{T(\mathcal{S})}(\tau_j, \chi_j(\tau_j)) \\
 &= d_{T(\mathcal{S})}(\tau_\infty, \chi(\tau_\infty)).
 \end{aligned}$$

Since  $\chi = \chi_j = \theta_j \circ \langle \omega|_{\mathcal{S}} \rangle \circ \theta_j^{-1}$  for all  $j > j_0$ , we have  $a(\langle \omega|_{\mathcal{S}} \rangle) = d_{T(\mathcal{S})}(\tau_0, \langle \omega|_{\mathcal{S}} \rangle(\tau_0))$  for  $\tau_0 = \theta_{j_0+1}^{-1}(\tau_\infty)$ . By Proposition 1,  $\langle \omega|_{\mathcal{S}} \rangle$  is hyperbolic.

To complete the proof of Proposition 3, we need to prove the claim. Set

$$\Lambda(d_0) = \min\{\lambda_1(d_0), \lambda_2(d_0)\},$$

where  $\lambda_1$  is the function defined in Lemma 9 and  $\lambda_2(d_0) = \sup\{l > 0 \mid \lambda_1(d_0)/3 > \lambda_0(d_0, l)\}$ .

For any  $j$ , let  $L_j$  be an admissible simple closed geodesic on  $f_j(\mathcal{S})$  which minimizes the hyperbolic length among all admissible simple closed geodesics on  $f_j(\mathcal{S})$ . We will prove  $l_{f_j(\mathcal{S})}(L_j) > \Lambda(d_0)$ .

First we consider the case where  $L_j$  is also admissible as a closed curve on  $\widehat{f}_j(\mathcal{S})$ . By condition (2a) of Main Theorem, we can take a point  $p \in L_j \cap (s_1^{f_j}(I) \cup s_2^{f_j}(I))$ . Denote by  $L$  a closed geodesic loop with base point  $p$  homotopic to  $L_j$  rel  $p$  on  $\widehat{f}_j(\mathcal{S})$ . Then Lemma 9 gives

$$(4.11) \quad \Lambda(d_0) \leq \lambda_1(d_0) < l_{\widehat{f}_j(\mathcal{S})}(L) \leq l_{\widehat{f}_j(\mathcal{S})}(L_j) \leq l_{f_j(\mathcal{S})}(L_j).$$

Next we consider the case where  $L_j$  is not admissible as a closed curve on  $\widehat{f}_j(\mathcal{S})$ . In this case, we can take a domain  $D \subset \widehat{f}_j(\mathcal{S})$  which is bounded by  $L_j$  and is topologically a disk or a once-punctured disk. Since  $L_j$  is admissible as a closed curve on  $f_j(\mathcal{S})$ , the domain  $D$  satisfies one of the following conditions.

- (a)  $D$  is topologically a once-punctured disk and  $D \cap \{\widehat{f}_j(p_1), \widehat{f}_j(p_2)\} \neq \emptyset$ .

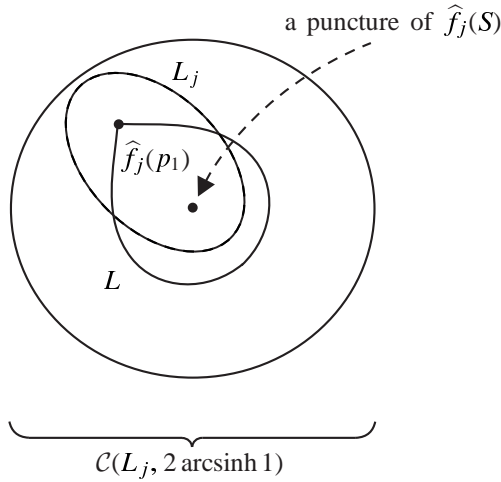

Fig. 3. A figure of case (a).

(b)  $D$  is topologically a disk including  $\{\widehat{f}_j(p_1), \widehat{f}_j(p_2)\}$ .  
 First, let us consider case (a). Without loss of generality, we may assume that  $\widehat{f}_j(p_1) \in D$ . Suppose that

$$l_{f_j(S)}(L_j) \leq \lambda_1(d_0).$$

Then we have  $l_{\widehat{f}_j(S)}(L_j) \leq l_{f_j(S)}(L_j) \leq \lambda_1(d_0) \leq \text{arcsinh } 1$ . Thus  $L_j$  is included in a cusp  $\mathcal{C}(L_j, 2 \text{arcsinh } 1)$  of  $\widehat{f}_j(S)$ . Take a simple closed geodesic loop  $L$  on  $\widehat{f}_j(S)$  with base point  $\widehat{f}_j(p_1)$  such that  $L$  is included in  $\mathcal{C}(L_j, 2 \text{arcsinh } 1)$  and is freely homotopic to  $L_j$  on  $\mathcal{C}(L_j, 2 \text{arcsinh } 1)$  (see Fig. 3). We obtain

$$l_{\widehat{f}_j(S)}(L) \leq l_{\widehat{f}_j(S)}(L_j) < l_{f_j(S)}(L_j) \leq \lambda_1(d_0).$$

This contradicts Lemma 9, and we conclude that

$$(4.12) \quad l_{f_j(S)}(L_j) > \lambda_1(d_0) \geq \Lambda(d_0).$$

Next we consider case (b) (see Fig. 4). Assume that

$$(4.13) \quad l_{f_j(S)}(L_j) \leq \lambda_2(d_0).$$

Since  $d_{\widehat{f}_j(S)}(\widehat{f}_j(p_1), \widehat{f}_j(p_2)) \leq l_{\widehat{f}_j(S)}(L_j) \leq l_{f_j(S)}(L_j)$ , the assumption (4.13) yields

$$d_{\widehat{f}_j(S)}(\widehat{f}_j(p_1), \widehat{f}_j(p_2)) \leq \lambda_2(d_0).$$

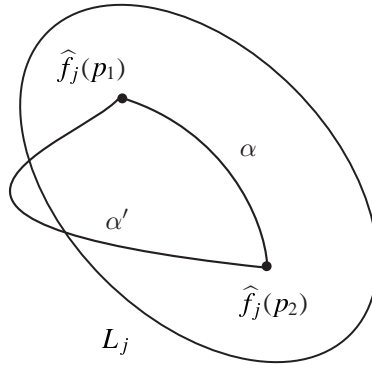

Fig. 4. A figure of case (b).

Thus, by Lemma 6, we obtain

$$(4.14) \quad d_{\widehat{f}_j(S)}(s_1^{f_j}(t), s_2^{f_j}(t)) \leq \lambda_0(d_0, \lambda_2(d_0)) \leq \frac{1}{3} \lambda_1(d_0)$$

for all  $t \in I$ . On the other hand, by Lemma 9, we have  $\min\{r_{\text{inj}}(\widehat{f}_j(S), s_1^{f_j}(t)) \mid t \in I\} > \lambda_1(d_0)/2$ . Let  $C_t \subset \widehat{f}_j(S)$  be the circle of radius  $\lambda_1(d_0)/2$  centered at  $s_1^{f_j}(t)$ . By (4.14), the circle  $C_t$  bounds a disk of  $\widehat{f}_j(S)$  including  $\{s_1^{f_j}(t), s_2^{f_j}(t)\}$  for each  $t \in I$ . Set  $C = C_0 = C_1$ . Then  $\omega_j(C)$  is freely homotopic to  $C$  on  $f_j(\dot{S})$  by the homotopy  $I \ni t \mapsto \omega_j \circ H_{\omega, f_j}(\cdot, t)^{-1}(C_t)$ . Hence  $C$  satisfies (1a) and (1b) of Lemma 8. This contradicts condition (2b) of Main Theorem, and we conclude that

$$(4.15) \quad l_{f_j(\dot{S})}(L_j) > \lambda_2(d_0) \geq \Lambda(d_0).$$

From inequalities (4.11), (4.12) and (4.15), we have inequality (4.10) for all  $j$  and all admissible simple closed geodesic  $L$  on  $f_j(\dot{S})$ . The claim is now proved.  $\square$

**4.6.** By the following two propositions, we obtain statement (1) of Main Theorem, which is necessary and sufficient condition for the Bers type of  $\langle \omega|_{\dot{S}} \rangle$  to be parabolic.

**Proposition 4.** *Let  $[\omega]$  be a non-trivial element of  $\text{Isot}(S, 2)$ . If  $\langle \omega|_{\dot{S}} \rangle$  is parabolic as an element of  $\text{Mod}(\dot{S})$ , then conditions (1a) and (1b) of Main Theorem hold.*

*Proof.* For any  $[f] \in T(\dot{S})$ , we denote the canonical isotopy between  $\text{id}$  and  $\omega_f$  by  $H_{\omega, f}$ , where  $\omega_f$  is the extremal quasiconformal self-map of  $f(\dot{S})$  isotopic to  $\widehat{f} \circ \omega^{-1} \circ \widehat{f}^{-1}|_{f(\dot{S})}$ .

Set  $D_j = \{p \in \widehat{f}(S) \mid d_{\widehat{f}(S)}(p, \widehat{f}(p_j)) < \text{arcsinh}(1/2)\}$ . If  $D_j$  is not a disk, then by the collar theorem (4.4.6 of Buser [4]) and hyperbolic trigonometry, it is included in

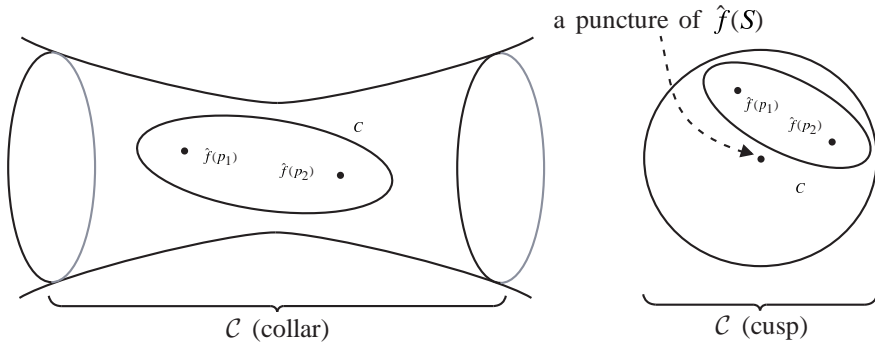

Fig. 5. Case that  $C$  is a trivial loop on  $\mathcal{C}$ .

a collar with central closed geodesic of length  $\leq 2 \operatorname{arcsinh} 1$  or in a cusp of  $\hat{f}(S)$ . On the other hand, since  $\langle \omega|_{\mathcal{S}}$  is parabolic, Lemma 2 and Lemma 5 together assert that there is a point  $[f]$  of  $T(\mathcal{S})$  such that  $s_j^f(I) \subset D_j$  for  $j = 1, 2$ . Thus condition (1a) of Main Theorem holds.

First we consider the case where  $D_{j_0}$  is a disk of  $\hat{f}(S)$  for some  $j_0 \in \{1, 2\}$ . We may assume that  $j_0 = 1$ . In this case, the closed curve  $s_1^f$  is trivial in  $\hat{f}(S)$  and so  $\omega|_{S \setminus \{p_1\}}$  is isotopic to the identity on  $S \setminus \{p_1\}$ . Thus, we can take an isotopy  $h'_\omega: S \times I \rightarrow S$  such that  $h'_\omega(\cdot, 0) = \operatorname{id}$ ,  $h'_\omega(\cdot, 1) = \omega$ , and  $h'_\omega(p_1, t) = p_1$  for any  $t \in I$ . Set  $s'_j(t) = h'_\omega(p_j, t)$  and  $b'_\omega = (s'_1, s'_2)$ . Then  $[b'_\omega]$  is a pure braid induced from  $\omega$ . Since  $\langle \omega|_{\mathcal{S}}$  is parabolic, Theorem 2 of Kra [10] implies that the closed curve  $s'_2$  is either a parabolic or a simple hyperbolic element of  $\pi_1(S \setminus \{p_1\}, p_2)$ . Hence, we conclude by Lemma 8 that the strings  $s_1$  and  $s_2$  are parallel or separable.

Next, we consider the case where there exists a domain  $\mathcal{C}_j \subset \hat{f}(S)$  such that

- (1)  $\mathcal{C}_j$  is either a collar with the central closed geodesic of length  $\leq 2 \operatorname{arcsinh} 1$  or a cusp of  $\hat{f}(S)$ , and
  - (2)  $D_j \subset \mathcal{C}_j$
- for each  $j = 1, 2$ .

If  $\mathcal{C}_1 \neq \mathcal{C}_2$ , then by the collar theorem, we have  $\mathcal{C}_1 \cap \mathcal{C}_2 = \emptyset$  and conclude that  $s_1$  and  $s_2$  are separable.

In the case of  $\mathcal{C}_1 = \mathcal{C}_2$ , we set  $\mathcal{C} = \mathcal{C}_1 = \mathcal{C}_2$ . There exists an orientation preserving self-homeomorphism  $\omega'_f$  of  $f(\mathcal{S})$  such that  $\omega'_f$  is isotopic to  $\omega_f$  on  $f(\mathcal{S})$  and is the identity on  $f(\mathcal{S}) \setminus \mathcal{C}$ . Since  $\langle \omega|_{\mathcal{S}} \rangle \in \operatorname{Mod}(\mathcal{S})$  is parabolic, the restricted map  $\omega'_f|_{\mathcal{C} \setminus \{\hat{f}(p_1), \hat{f}(p_2)\}}$  is reducible. Thus there exists an admissible simple closed curve  $C$  of  $\mathcal{C} \setminus \{\hat{f}(p_1), \hat{f}(p_2)\}$  such that  $\omega'_f(C)$  is freely homotopic to  $C$  on  $\mathcal{C} \setminus \{\hat{f}(p_1), \hat{f}(p_2)\}$ .

If  $C$  is a trivial loop on  $\mathcal{C}$ , then by Lemma 8, the strings  $s_1$  and  $s_2$  are parallel (see Fig. 5).

If  $C$  is a non-trivial loop on  $\mathcal{C}$ , then  $\mathcal{C} \setminus C$  consists of two components  $A_j$  with  $\hat{f}(p_j) \in A_j$  ( $j = 1, 2$ ), and each  $A_j$  is conformally equivalent to an annulus or a once-punctured disk (see Fig. 6). By Baer-Zieschang theorem (A.3 of Buser [4]), we

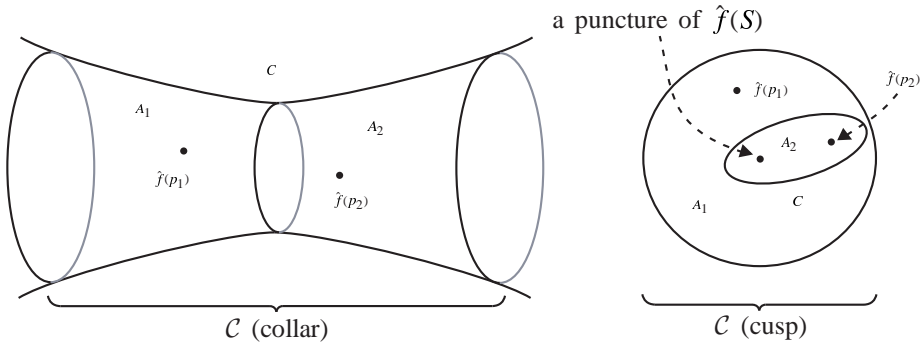

Fig. 6. Case that  $C$  is a non-trivial loop on  $\hat{C}$ .

may assume that  $\omega'_f(p) = p$  for any  $p \in C$ .

Assume that  $A_j$  is conformally equivalent to an annulus for each  $j = 1, 2$ . Then, by Proposition A.13 of Buser [4], each  $\omega'_f|_{A_j}$  is isotopic to the  $m_j$ -th power of the Dehn twist with an isotopy fixing  $\partial A_j$  pointwise. Since  $\omega'_f: \hat{f}(S) \rightarrow \hat{f}(S)$  is isotopic to the identity of  $\hat{f}(S)$ , we obtain  $m_1 = -m_2$ . Consequently, we can construct an isotopy  $h_{\omega'_f}: \hat{f}(S) \times I \rightarrow \hat{f}(S)$  such that

- (1)  $h_{\omega'_f}(\cdot, 0) = \text{id}$ ,
- (2)  $h_{\omega'_f}(\cdot, 1) = \omega'_f$ , and
- (3)  $h_{\omega'_f}(C, t) = C$  for any  $t \in I$ .

Hence we conclude that the strings  $s_1$  and  $s_2$  are separable.

In the case where  $A_j$  is conformally equivalent to a once-punctured disk for some  $j = 1$  or  $2$ , we obtain similarly that the strings  $s_1$  and  $s_2$  are separable. □

**4.7.** Finally, we prove the converse of Proposition 4.

**Proposition 5.** *If a non-trivial element  $[\omega] \in \text{Isot}(S, 2)$  satisfies conditions (1a) and (1b) of Main Theorem, then  $\langle \omega|_S \rangle$  is parabolic as an element of  $\text{Mod}(\hat{S})$ .*

*Proof.* Let  $[b_\omega]$  be the pure braid induced from  $[\omega]$ . Assume that  $b_\omega = (s_1, s_2)$  satisfies conditions (1a) and (1b) of Main Theorem.

If  $s_1$  and  $s_2$  are separable, then we can find a representative  $(s'_1, s'_2) \in [b_\omega]$  and a system  $\{C_1, \dots, C_{k_0}\}$  of disjoint non-trivial simple closed curves on  $S$  such that there exist two components  $D_1$  and  $D_2$  of  $S \setminus (C_1 \cup \dots \cup C_{k_0})$  satisfying  $s'_1(I) \subset D_1$  and  $s'_2(I) \subset D_2$ . We can take a subset  $\{C'_1, \dots, C'_{k_1}\}$  ( $k_1 \leq k_0$ ) of  $\{C_1, \dots, C_{k_0}\}$  such that

- (1)  $\{C'_1, \dots, C'_{k_1}\}$  is an admissible curve system of  $\hat{S}$ , i.e., each  $C'_k$  is an admissible simple closed curve of  $\hat{S}$  and no  $C'_k$  is freely homotopic to a curve  $C'_j$  ( $j \neq k$ ) on  $\hat{S}$ , and
- (2) there exist two components  $D'_1$  and  $D'_2$  of  $S \setminus (C'_1 \cup \dots \cup C'_{k_1})$  satisfying  $s'_1(I) \subset D'_1$  and  $s'_2(I) \subset D'_2$ .



We may assume that  $\omega|_{S \setminus (D'_1 \cup D'_2)} = \text{id}$ . For each  $j = 1, 2$ , the domain  $D'_j$  has a finite topological type  $(g_j, n_j)$  satisfying either  $2g_j - 2 + n_j > 0$  or  $(g_j, n_j) = (0, 2)$ . Let  $D''_j$  be a Riemann surface of analytically finite type  $(g_j, n_j)$ , and  $w_j$  a homeomorphism of  $D'_j$  onto  $D''_j$ . Set  $\omega_j = w_j \circ \omega|_{D'_j} \circ w_j^{-1}$ . If  $(g_j, n_j) = (0, 2)$ , then  $\omega_j|_{D''_j \setminus \{w_j(p_j)\}}$  is a sense preserving homeomorphism isotopic to the identity on  $D''_j \setminus \{w_j(p_j)\}$ . If the topological type  $(g_j, n_j)$  of  $D'_j$  satisfies  $2g_j - 2 + n_j > 0$ , then by condition (1a) and Theorem 2 of Kra [10], the element  $\langle \omega_j|_{D''_j \setminus \{w_j(p_j)\}} \rangle \in \text{Mod}(D''_j \setminus \{w_j(p_j)\})$  is the identity or parabolic. Hence we conclude that  $\langle \omega|_S \rangle$  is parabolic.

Next, we consider the case where the strings  $s_1$  and  $s_2$  are parallel. Deforming, if necessary, the closed path  $b_\omega = (s_1, s_2)$  and its base point in  $M \setminus \Delta$  continuously, we may assume, by condition (1a) of Main Theorem, that there exists a domain  $\mathcal{C}$  of  $S$  such that

- (1)  $\mathcal{C}$  is either a collar, a cusp, or topologically a disk of  $S$ , and
- (2)  $s_2(I) \subset \mathcal{C}$ .

There exists a number  $r_0 > 0$  such that, for each  $t \in I$ , the set  $C_t(r_0) = \{p \in S \mid d_S(s_2(t), p) = r_0\}$  is a circle centered at  $s_2(t)$  with  $C_t(r_0) \subset \mathcal{C}$ . Set  $C = C_0(r_0) = C_1(r_0)$ . By Lemma 7, we may assume that  $d_S(s_1(t), s_2(t)) < r_0/2$  for all  $t \in I$ , and then conclude that  $\omega(C)$  is freely homotopic to  $C$  on  $\dot{S}$ . Hence  $\langle \omega|_S \rangle$  is parabolic as an element of  $\text{Mod}(\dot{S})$ . □

Now Proposition 1 through 5 together yield our Main Theorem.

### 5. Examples of Main Theorem

Let us illustrate a few examples of Main Theorem. Set  $S = \mathbf{C} \setminus \{0, 1, 2\}$ , where  $\mathbf{C}$  is the complex plane. Then  $S$  is a Riemann surface of type  $(0, 4)$ . Let  $[\omega]$  be an element of  $\text{Isot}(S, 2)$  which induces a pure braid  $[b_\omega] = [(s_1, s_2)]$ , where  $s_1$  and  $s_2$  are strings of  $b_\omega$ .

First consider a pure braid  $[b_\omega]$  in (a) of Fig. 7. Then  $[b_\omega]$  satisfies conditions (2a), (2b) and (2c) of Main Theorem, so  $\langle \omega|_S \rangle$  is hyperbolic.

If  $[b_\omega]$  is illustrated in (b), then it satisfies conditions (2b) and (2c). On the other hand, there exists an admissible simple closed curve  $C$  on  $S$  such that  $C$  does not intersect the images of  $s_1$  and  $s_2$ . Thus the pure braid  $[b_\omega]$  is not essential, and  $\langle \omega|_S \rangle$  is not hyperbolic. Actually  $\langle \omega|_S \rangle$  is pseudo-hyperbolic, because condition (1a) is not satisfied.

Fig. (c) shows an example of  $[b_\omega]$  satisfying condition (2a), but does not satisfy condition (2c). Hence  $\langle \omega|_S \rangle$  is not hyperbolic, in fact it is pseudo-hyperbolic, because condition (1a) is not satisfied.

Fig. (d) illustrates an example of  $[b_\omega]$  which satisfies neither condition (2a) nor (2c). Therefore  $\langle \omega|_S \rangle$  is not hyperbolic. On the other hand, it satisfies conditions (1a) and (1b). Hence it is parabolic.

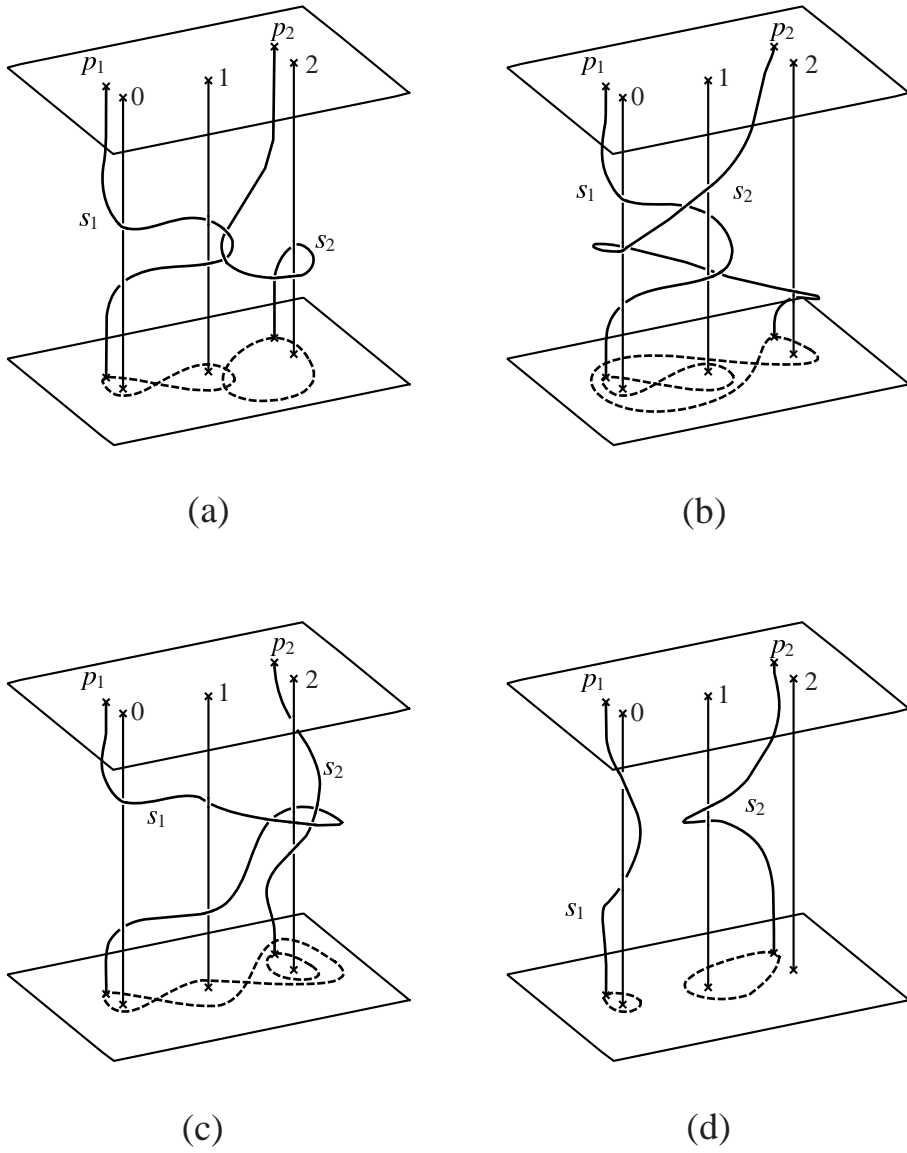

Fig. 7. The pure braids  $b_\omega$  induced from  $\omega$ .

## References

- [1] L. Bers: *An extremal problem for quasiconformal mappings and a theorem by Thurston*, Acta Math. **141** (1978), 73–98.
- [2] J.S. Birman: *The algebraic structure of surface mapping class group*, Chapter 6 of Discrete Groups and Automorphic Functions, Edited by W.J. Harvey, Academic Press, London, 1977, 163–198.
- [3] J.S. Birman: *Braids, Links, and Mapping Class Groups*, Ann. of Math. Studies 82, Princeton Univ. Press, Princeton, New Jersey, 1974.
- [4] P. Buser: *Geometry and Spectra of Compact Riemann Surfaces*, Progress in Mathematics 106, Birkhäuser, Boston, 1992.
- [5] C.J. Earle and C. McMullen: *Quasiconformal isotopies*, in Holomorphic functions and moduli I (Berkeley, CA, 1986), Math. Sci. Res. Inst. Publ., 10, Springer, New York, 1988, 143–154.
- [6] F.P. Gardiner: *Teichmüller Theory and Quadratic Differentials*, Wiley, New York, 1987.
- [7] F.P. Gardiner and N. Lakic: *Quasiconformal Teichmüller Theory*, Mathematical Surveys and Monographs, **76**, American Mathematical Society, Providence, RI, 2000.
- [8] F.W. Gehring: *Quasiconformal mappings which hold the real axis pointwise fixed*, in Mathematical Essays dedicated to A.J. Macintyre, Ohio Univ. Press, 1970, Athens, Ohio, 145–148.
- [9] Y. Imayoshi, M. Ito and H. Yamamoto: *A remark on the Bers type of some self-maps of Riemann surfaces with two specified points*, in Proceedings of the Second ISSAC Congress, ed. by H.G.W. Begehr, R.P. Gilbert and J. Kajiwara, International Society for Analysis, Applications and Computation, **8**, 871–875, Kluwer Academic Publishers, 2000.
- [10] I. Kra: *On the Nielsen-Thurston-Bers type of some self-maps of Riemann surfaces*, Acta Math. **146** (1981), 231–270.
- [11] O. Lehto and K.I. Virtanen: *Quasiconformal mappings in the plane*, Springer-Verlag, Berlin and New York, 1973.
- [12] B. Maskit: *Kleinian Groups*, Springer-Verlag, Berlin and New York, 1987.
- [13] O. Teichmüller: *Ein Verschiebungssatz der quasikonformen Abbildung*, Deutsche Math. **7** (1944), 336–343.
- [14] W.P. Thurston: *On the geometry and dynamics of diffeomorphisms of surfaces*, Bull. A.M.S. (New Series) **19** (1988), 417–431.
- [15] A. Yamada: *On Marden's universal constant of Fuchsian groups*, II, Journal d'Analyse Mathématique **41** (1982), 234–248.

Yoichi Imayoshi

Department of Mathematics, Osaka City University  
Sugimoto, Sumiyoshi-ku, Osaka 558-0022, Japan  
e-mail: imayoshi@sci.osaka-cu.ac.jp

Manabu Ito

Department of Mathematics, Osaka City University  
Sugimoto, Sumiyoshi-ku, Osaka 558-0022, Japan

Current Address:

10-20-101, Hirano-kita 1 chome, Hirano-ku  
Osaka 547-0041, Japan  
e-mail: cbj89070@pop02.odn.ne.jp

Hiroshi Yamamoto

Department of Mathematics, Osaka City University  
Sugimoto, Sumiyoshi-ku, Osaka 558-0022, Japan  
e-mail: yadamo@sci.osaka-cu.ac.jp