

## HOPF CYCLIC COHOMOLOGY IN BRAIDED MONOIDAL CATEGORIES

MASOUD KHALKHALI AND ARASH POURKIA

*(communicated by Jean-Louis Loday)*

### *Abstract*

We extend the formalism of Hopf cyclic cohomology to the context of braided categories. For a Hopf algebra in a braided monoidal abelian category we introduce the notion of stable anti-Yetter-Drinfeld module. We associate a para-cocyclic and a cocyclic object to a braided Hopf algebra endowed with a braided modular pair in involution in the sense of Connes and Moscovici. When the braiding is symmetric the full formalism of Hopf cyclic cohomology with coefficients can be extended to our categorical setting.

### 1. Introduction

In [6, 7, 8], Connes and Moscovici, motivated by transverse index theory for foliations, defined a cohomology theory of cyclic type for Hopf algebras by introducing the concept of a modular pair in involution. This theory was later extended, by the first author and collaborators [10, 11, 14, 15], by introducing the notion of a stable anti-Yetter-Drinfeld module as coefficients for a cyclic cohomology theory of algebras or coalgebras endowed with an action or coaction of a Hopf algebra. Modular pairs in involution appeared naturally as one dimensional stable anti-Yetter-Drinfeld modules in this latter theory. It is by now clear that Hopf cyclic cohomology is the right noncommutative analogue of group homology and Lie algebra homology. In particular it allows an extension of Connes' theory of noncommutative characteristic classes [4, 5] to a setup involving an action of a Hopf algebra or quantum group [6, 7].

There are many examples of Hopf algebra-like objects that are close to being a Hopf algebra but are not a Hopf algebra in the usual sense. Examples include (differential graded) super Hopf algebras, quasi-Hopf algebras, multiplier Hopf algebras, Hopf algebroids, and locally compact quantum groups. In some cases, but certainly not always, these objects are Hopf algebras in an appropriate monoidal category. Differential graded super Hopf algebras and quasi-Hopf algebras are examples of this. Study of Hopf algebras in symmetric monoidal categories goes back to [21]. Recent work on braided Hopf algebras is mostly motivated by low dimensional topology [18, 19, 22].

In this paper we work in an arbitrary braided monoidal abelian category and

---

Received December 29, 2008, revised September 18, 2009; published on March 18, 2010.

2000 Mathematics Subject Classification: 58B34.

Key words and phrases: noncommutative geometry, Hopf algebra, braided monoidal category, Hopf cyclic cohomology.

This article is available at <http://intlpress.com/HHA/v12/n1/a9>

Copyright © 2010, International Press. Permission to copy for private use granted.

extend the notion of a stable anti-Yetter-Drinfeld module over a Hopf algebra in such a category. We show that to any braided Hopf algebra endowed with a braided modular pair in involution one can associate a para-cocyclic object. This para-cocyclic object is cyclic if the ambient category is symmetric. In fact Theorem 7.3 (cf. also Remark 7.4), shows that this para-cocyclic object is almost never cocyclic if the category is not symmetric. Of course, as with any para-cocyclic object, by restricting to an appropriate subspace we obtain a cocyclic object.

In the symmetric case one can go much further. In this case and for an arbitrary braided stable anti-Yetter-Drinfeld module we obtain a cocyclic object. In fact in this case it is no longer needed to restrict to Hopf algebras and one can work with module coalgebras. As a special case, we define a Hopf cyclic cohomology for a (differential graded) super Hopf algebra and relate it to the cohomology of super Lie algebras by considering the enveloping algebra of a super Lie algebra.

The paper is organized as follows. In Section 2 we recall basic notions of braided monoidal categories and *braided Hopf algebras* which are, by definition, Hopf algebra objects in such categories. In Section 3 we define the notion of a stable anti-Yetter-Drinfeld (SAYD) module for a braided Hopf algebra. For symmetric braidings, we define a Hopf cyclic cohomology theory for triples  $(H, C, M)$  consisting of a coalgebra object endowed with an action of a braided Hopf algebra  $H$ , and a braided SAYD module  $M$ . In Section 4 we show that when  $C = H$  the Hopf cyclic complex of the triple  $(C, C, {}^\sigma I_\delta)$  simplifies and we compute the resulting cocyclic object. In Sections 5 and 6 we focus on the special case of (differential graded) super Hopf algebras and show that, for the universal enveloping algebra of a (differential graded) super Lie algebra, Hopf cyclic cohomology reduces to Lie algebra homology.

The last section is in a sense the heart of this paper. Here we work in an arbitrary braided monoidal category and show that, for one dimensional SAYD's, one can always define a para-cocyclic object for a braided Hopf algebra. We compute powers of the cyclic operator and express it in terms of the braiding of the category (Theorem 7.3 and Remark 7.4). Extending these results to more general braided SAYD's and to braided triples  $(H, C, M)$  is not straightforward and requires introducing extra structures. This more general case will be dealt with elsewhere.

We should mention that the cyclic cohomology of (*ribbon*)-algebras in braided monoidal abelian categories has been introduced and studied in [1], motivated by non-associative geometry.

## Acknowledgements

We would like to thank the referee for very helpful comments on the paper.

## 2. Hopf algebras in braided monoidal categories

Recall that a *monoidal*, or *tensor*, category  $(\mathcal{C}, \otimes, I, a, l, r)$  consists of a category  $\mathcal{C}$ , a functor  $\otimes: \mathcal{C} \times \mathcal{C} \rightarrow \mathcal{C}$ , an object  $I \in \mathcal{C}$  (called *unit object*), and natural isomorphisms, defined for all objects  $A, B, C$ , of  $\mathcal{C}$ ,

$$\begin{aligned} a &= a_{A,B,C}: A \otimes (B \otimes C) \rightarrow (A \otimes B) \otimes C, \\ l &= l_A: I \otimes A \rightarrow A, \quad r = r_A: A \otimes I \rightarrow A, \end{aligned}$$

(called the *associativity* and *unit constraints*, respectively), such that the following *pentagon* and *triangle* diagrams commute [17, 19]:

$$\begin{array}{ccc}
 & (A \otimes B) \otimes C \otimes D & \\
 \swarrow & & \searrow \\
 (A \otimes (B \otimes C)) \otimes D & & (A \otimes B) \otimes (C \otimes D) \\
 \downarrow & & \downarrow \\
 A \otimes ((B \otimes C) \otimes D) & \longrightarrow & A \otimes (B \otimes (C \otimes D))
 \end{array}
 \qquad
 \begin{array}{ccc}
 (A \otimes I) \otimes B & \longrightarrow & A \otimes (I \otimes B) \\
 \swarrow & & \searrow \\
 & A \otimes B &
 \end{array}$$

The coherence theorem of Mac Lane [17] asserts that all diagrams formed by  $a, l, r$  by tensoring and composing, commute. More precisely, it asserts that any two natural transformations defined by  $a, l, r$  between any two functors defined by  $\otimes$  and  $I$  are equal.

A *braided monoidal* category is a monoidal category  $\mathcal{C}$  endowed with a natural family of isomorphisms

$$\psi_{A,B}: A \otimes B \rightarrow B \otimes A,$$

called *braiding* such that for all objects  $A, B, C$  of  $\mathcal{C}$  the following diagrams commute (*hexagon axioms*):

$$\begin{array}{ccccc}
 & & A \otimes (B \otimes C) & \xrightarrow{\psi} & (B \otimes C) \otimes A \\
 & \nearrow^{a^{-1}} & & & \searrow^{a^{-1}} \\
 (A \otimes B) \otimes C & & & & B \otimes (C \otimes A) \\
 & \searrow_{\psi \otimes id} & & & \nearrow_{id \otimes \psi} \\
 & & (B \otimes A) \otimes C & \xrightarrow{a^{-1}} & B \otimes (A \otimes C) \\
 & & & & \\
 & & (A \otimes B) \otimes C & \xrightarrow{\psi} & C \otimes (A \otimes B) \\
 & \nearrow^a & & & \searrow^a \\
 A \otimes (B \otimes C) & & & & (C \otimes A) \otimes B \\
 & \searrow_{id \otimes \psi} & & & \nearrow_{\psi \otimes id} \\
 & & A \otimes (C \otimes B) & \xrightarrow{a} & (A \otimes C) \otimes B
 \end{array}$$

If we show the braiding map  $\psi_{A,B}$  by the following standard diagram as in [1, 19],

$$\begin{array}{ccc}
 A & & B \\
 & \psi_{A,B} & \\
 & \underbrace{\hspace{2cm}} & \\
 B & & A
 \end{array}$$

for any  $A$  and  $B$  in  $\mathcal{C}$ , then the naturality of  $\psi$  can be visualized by the following

identity:

$$\begin{array}{ccc}
 \begin{array}{c} A \quad B \\ \bullet f \quad \bullet g \\ \underbrace{\quad \quad}_{\psi_{A',B'}} \\ B' \quad A' \end{array} & = & \begin{array}{c} A \quad B \\ \underbrace{\quad \quad}_{\psi_{A,B}} \\ \bullet g \quad \bullet f \\ B' \quad A' \end{array}
 \end{array} \quad (1)$$

for any two morphisms  $f: A \rightarrow A'$  and  $f: B \rightarrow B'$  in  $\mathcal{C}$ . Notice that in special case when for example  $B = I$ , since

$$\psi_{I,A} = \psi_{A,I} = id_A, \quad \forall A \in \mathcal{C}, \quad (2)$$

we have

$$\begin{array}{ccc}
 \begin{array}{c} A \\ \bullet f \quad \circ g \\ \underbrace{\quad \quad}_{\psi_{A',B'}} \\ B' \quad A' \end{array} & = & \begin{array}{c} A \\ \circ g \quad \bullet f \\ B' \quad A' \end{array}
 \end{array} \quad (3)$$

In other cases when  $A, A'$  or  $B'$  is  $I$  the naturality identities can be simplified in a similar way.

A braiding is called a *symmetry* if we have

$$\psi_{B,A} \circ \psi_{A,B} = id_{A \otimes B},$$

or in terms of braiding diagrams:

$$\begin{array}{ccc}
 \begin{array}{c} A \quad B \\ \underbrace{\quad \quad}_{\psi_{A,B}} \\ \underbrace{\quad \quad}_{\psi_{B,A}} \\ A \quad B \end{array} & = & \begin{array}{c} A \quad B \\ | \quad | \\ A \quad B \end{array}
 \end{array} \quad (4)$$

for all objects  $A$  and  $B$  of  $\mathcal{C}$ . Sometimes we just write  $\psi^2 = id$  to signify the symmetry condition. A *symmetric monoidal category* is a monoidal category endowed with a symmetry.

A monoidal category is called *strict* if its associativity and unit isomorphisms are in fact equalities. By a theorem of Mac Lane [17] (cf. also [19]), any (braided) monoidal category is *monoidal equivalent* to a (braided) strict monoidal category in which  $a, l$  and  $r$  are just equalities and the above commuting diagrams are reduced to the following equalities:

$$(A \otimes B) \otimes C = A \otimes (B \otimes C)$$

$$I \otimes A = A \otimes I = A$$

$$\psi_{A,B \otimes C} = (id_B \otimes \psi_{A,C})(\psi_{A,B} \otimes id_C)$$

$$\psi_{A \otimes B,C} = (\psi_{A,C} \otimes id_B)(id_A \otimes \psi_{B,C})$$

for all objects  $A, B, C$  of  $\mathcal{C}$ . The last identity in terms of braided diagrams is as follows:

$$\begin{array}{ccc}
 \begin{array}{c} A \quad B \quad C \\ \underbrace{\quad \quad}_{\psi_{A \otimes B,C}} \\ C \quad A \quad B \end{array} & = & \begin{array}{c} A \quad B \quad C \\ \underbrace{\quad \quad}_{\psi_{A,C}} \underbrace{\quad \quad}_{\psi_{B,C}} \\ C \quad A \quad B \end{array}
 \end{array}$$

The other one is the same.

We note that if the original category is symmetric then its *strictification* is symmetric as well. This plays an important role in our approach. In fact, using this result, we can safely assume that our symmetric monoidal categories are strict and symmetric. Working with strict categories drastically simplifies the formalism and that is what we shall do in this paper.

*Example 2.1.* Let  $(H, R = R_1 \otimes R_2)$  be a quasitriangular Hopf algebra and  $\mathcal{C}$  be the category of all left  $H$ -modules. Then  $\mathcal{C}$  is a braided monoidal abelian category. It is symmetric if and only if  $R^{-1} = R_2 \otimes R_1$  [19]. Here the monoidal structure is defined by

$$h \triangleright (v \otimes w) = h^{(1)} \triangleright v \otimes h^{(2)} \triangleright w,$$

and the braiding map  $\psi_{V \otimes W}$  acts by

$$\psi_{V \otimes W}(v \otimes w) := (R_2 \triangleright w \otimes R_1 \triangleright v),$$

for any  $V$  and  $W$  in  $\mathcal{C}$ , where  $\triangleright$  denotes the action of  $H$ . Throughout this paper we use Sweedler's notation, with summation understood, e.g. we write  $\Delta h = h^{(1)} \otimes h^{(2)}$  to denote the comultiplication of Hopf algebras.

*Example 2.2.* In a dual manner if we consider a co-quasitriangular Hopf algebra  $(H, R)$ , then the category of left  $H$ -comodules is a braided monoidal abelian category.

*Example 2.3.* As a very special case of Example 2.1, let  $H = \mathbb{C}\mathbb{Z}_2$  with the non-trivial quasitriangular structure  $R = R_1 \otimes R_2$  defined by

$$R := \left(\frac{1}{2}\right)(1 \otimes 1 + 1 \otimes g + g \otimes 1 - g \otimes g),$$

where  $g$  is the generator of the cyclic group  $\mathbb{Z}_2$ . The category  $\mathcal{C} = \mathbb{Z}_2\text{-Mod}$  then is the category of super vector spaces with even morphisms [19]. The braiding map  $\psi_{V \otimes W}$  for any  $V = V_0 \oplus V_1$  and  $W = W_0 \oplus W_1$  in  $\mathcal{C}$  acts as below:

$$\psi_{V \otimes W}(v \otimes w) = (-1)^{|v||w|} (w \otimes v). \quad (5)$$

There is also a category of differential graded (DG) super vector spaces whose objects are super complexes

$$V_0 \begin{array}{c} \xleftarrow{d} \\ \xrightarrow{d} \end{array} V_1,$$

and its morphisms are even chain maps. It is a braided monoidal category with the same braiding map as (5).

*Remark 2.4.* One can extend Example 2.3 to  $\mathbb{C}\mathbb{Z}_n$  for any  $n > 2$  which provides a good source of non-symmetric braided monoidal categories [19].

*Example 2.5.* Let  $H$  be a Hopf algebra over a field  $k$  with comultiplication  $\Delta h = h^{(1)} \otimes h^{(2)}$  and a bijective antipode  $S$ . A left-left Yetter-Drinfeld (YD)  $H$ -module

consist of a vector space  $V$ , a left  $H$ -module structure on  $V$  [20, 23]

$$H \otimes V \rightarrow V, \quad h \otimes v \mapsto hv,$$

and a left  $H$ -comodule structure on  $V$

$$V \rightarrow H \otimes V, \quad v \mapsto v_{(-1)} \otimes v_{(0)}.$$

The left action and coaction are supposed to satisfy the Yetter-Drinfeld (YD) compatibility condition:

$$(hv)_{(-1)} \otimes (hv)_{(0)} = h^{(1)}v_{(-1)}S(h^{(3)}) \otimes h^{(2)}v_{(0)},$$

for all  $h \in H$  and  $v \in V$ . The category of all YD  $H$ -modules is called the Yetter-Drinfeld category of  $H$ , and is usually denoted by  ${}^H_H\mathcal{YD}$ . It is a braided monoidal abelian category with the braiding map:

$$\psi_{V \otimes W}(v \otimes w) = v_{(-1)}w \otimes v_{(0)}.$$

This category is in general not symmetric. In fact the inverse of the braiding is given by:

$$\psi_{V \otimes W}^{-1}(w \otimes v) = v_{(0)} \otimes S^{-1}(v_{(-1)})w.$$

**Definition 2.6.** Let  $\mathcal{C}$  be a strict braided monoidal category. A Hopf algebra  $(H, m, \eta, \Delta, \varepsilon, S)$  in  $\mathcal{C}$  consists of an object  $H \in \text{obj } \mathcal{C}$ , morphisms  $m: H \otimes H \rightarrow H$ ,  $\eta: I \rightarrow H$ ,  $\Delta: H \rightarrow H \otimes H$ ,  $\varepsilon: H \rightarrow I$  and  $S: H \rightarrow H$  called multiplication, unit, comultiplication, counit and antipode maps satisfying the relations:

$$m(id \otimes m) = m(m \otimes id), \quad \text{associativity}$$

$$\begin{array}{c} H \quad H \quad H \\ \left. \begin{array}{l} \text{---} \\ \text{---} \\ \text{---} \end{array} \right\} \\ H \end{array} = \begin{array}{c} H \quad H \quad H \quad H \\ \left. \begin{array}{l} \text{---} \\ \text{---} \\ \text{---} \end{array} \right\} \\ H \end{array} = \begin{array}{c} H \\ | \\ H \end{array}$$

$$m(\eta \otimes id) = m(id \otimes \eta) = id, \quad \text{unit}$$

$$\begin{array}{c} H \\ \circlearrowleft \eta \\ \left. \begin{array}{l} \text{---} \\ \text{---} \end{array} \right\} \\ H \end{array} = \begin{array}{c} H \quad H \\ \left. \begin{array}{l} \text{---} \\ \text{---} \end{array} \right\} \\ H \end{array} \circlearrowright \eta = \begin{array}{c} H \\ | \\ H \end{array}$$

$$(id \otimes \Delta)\Delta = (\Delta \otimes id)\Delta, \quad \text{coassociativity}$$

$$\begin{array}{c} H \\ \left. \begin{array}{l} \text{---} \\ \text{---} \end{array} \right\} \\ H \quad H \quad H \end{array} = \begin{array}{c} H \\ \left. \begin{array}{l} \text{---} \\ \text{---} \end{array} \right\} \\ H \quad H \quad H \end{array}$$

$$(\varepsilon \otimes id)\Delta = (id \otimes \varepsilon)\Delta = id, \quad \text{counit}$$

$$\begin{array}{c} H \\ \left. \begin{array}{l} \text{---} \\ \text{---} \end{array} \right\} \\ H \end{array} \bullet \varepsilon = \begin{array}{c} H \\ \bullet \varepsilon \\ \left. \begin{array}{l} \text{---} \\ \text{---} \end{array} \right\} \\ H \end{array} = \begin{array}{c} H \\ | \\ H \end{array}$$

$$\Delta m = (m \otimes m)(id \otimes \psi \otimes id)(\Delta \otimes \Delta), \quad \text{compatibility}$$

$$(6)$$

$$\Delta \eta = \eta \otimes \eta, \quad \varepsilon m = \varepsilon \otimes \varepsilon, \quad \varepsilon \eta = id_I$$

$$(7)$$

$$m(S \otimes id)\Delta = m(id \otimes S)\Delta = \eta\varepsilon, \quad \text{antipode}$$

$$(8)$$

By a braided Hopf algebra we mean a Hopf algebra in a braided monoidal category.

Notice that relation (6), which expresses the algebra property of the comultiplication, is the only relation that involves the braiding map  $\psi$ .

**Lemma 2.7.** *It is easy to prove that*

$$\begin{aligned} \Delta^2 m &= (m \otimes m \otimes m)(id \otimes \psi \otimes id \otimes id \otimes id) \\ &\quad (id \otimes id \otimes id \otimes \psi \otimes id)(id \otimes id \otimes \psi \otimes id \otimes id)(\Delta^2 \otimes \Delta^2). \end{aligned}$$

$$(9)$$

*Example 2.8.* Any Hopf algebra in  $\mathbb{Z}_2$ -Mod of Example 2.3 is called a super Hopf algebra. See Section 5 for more details. Similarly, a Hopf algebra in the category of differential graded super vector spaces is a differential graded super Hopf algebra.

Notice that a super Hopf algebra is, in general, not a standard Hopf algebra, since the comultiplication  $\Delta$  is not an algebra map, and the multiplication  $m$  is not a coalgebra map in the standard sense.

*Example 2.9.* For any  $V$  in  ${}^H_H\mathcal{YD}$  of Example 2.5, the tensor algebra  $T(V)$  is a braided Hopf algebra in  ${}^H_H\mathcal{YD}$ . Its comultiplication, counit, and antipode are defined by  $\Delta(v) = 1 \otimes v + v \otimes 1$ ,  $\varepsilon(v) = 0$ , and  $S(v) = -v$ , for all  $v$  in  $V$ .

The following proposition shows that standard properties of Hopf algebras hold for braided Hopf algebras.

**Proposition 2.10.** *If  $(H, m, \eta, \Delta, \varepsilon, S)$  is a braided Hopf algebra (in  $\mathcal{C}$ ), then:*

$$Sm = m\psi(S \otimes S) = m(S \otimes S)\psi,$$

$$\begin{array}{c} H \quad H \\ \swarrow \quad \searrow \\ \bullet S \\ \downarrow \\ H \end{array} = \begin{array}{c} H \quad H \\ \swarrow \quad \searrow \\ \bullet S \quad \bullet S \\ \downarrow \quad \downarrow \\ \psi \\ \downarrow \\ H \end{array} = \begin{array}{c} H \quad \psi \quad H \\ \swarrow \quad \searrow \\ \bullet S \quad \bullet S \\ \downarrow \\ H \end{array} \quad (10)$$

$$S\eta = \eta, \quad \varepsilon S = \varepsilon,$$

$$\begin{array}{c} \circ \eta \\ \downarrow \\ \bullet S \\ \downarrow \\ H \end{array} = \begin{array}{c} \circ \eta \\ \downarrow \\ H \end{array} \quad \begin{array}{c} H \quad H \\ \downarrow \quad \downarrow \\ \bullet S \quad \bullet \varepsilon \\ \downarrow \quad \downarrow \\ \circ \quad \circ \end{array} = \begin{array}{c} H \quad H \\ \downarrow \quad \downarrow \\ \bullet \varepsilon \quad \circ \end{array} \quad (11)$$

$$\Delta S = \psi(S \otimes S)\Delta = (S \otimes S)\psi\Delta.$$

$$\begin{array}{c} H \\ \downarrow \\ \bullet S \\ \swarrow \quad \searrow \\ H \quad H \end{array} = \begin{array}{c} H \\ \downarrow \\ \bullet S \quad \bullet S \\ \downarrow \quad \downarrow \\ \psi \\ \downarrow \\ H \quad H \end{array} = \begin{array}{c} H \\ \downarrow \\ \psi \\ \downarrow \\ \bullet S \quad \bullet S \\ \downarrow \quad \downarrow \\ H \quad H \end{array} \quad (12)$$

*Proof.* See [19]. □

**Definition 2.11.** Let  $H$  be a braided Hopf algebra in  $\mathcal{C}$ . A right  $H$ -module is an object  $M$  in  $\mathcal{C}$  equipped with a morphism  $\phi_M: M \otimes H \rightarrow M$ , called  $H$  action, such that:

$$(\phi)(id_M \otimes m_H) = (\phi)(\phi \otimes id_H), \quad (\phi)(id_M \otimes \eta_H) = id_M.$$

$$\begin{array}{c} M \quad H \quad H \\ \downarrow \quad \downarrow \\ \phi_M \\ \downarrow \\ M \end{array} = \begin{array}{c} M \quad H \quad H \\ \downarrow \quad \downarrow \\ \phi_M \\ \downarrow \\ M \end{array} \quad \begin{array}{c} M \\ \downarrow \\ \phi_M \quad \circ \eta \\ \downarrow \\ M \end{array} = \begin{array}{c} M \\ \downarrow \\ M \end{array}$$



A left  $H$ -comodule is an object  $M$  in  $\mathcal{C}$  equipped with a morphism  $\rho_M: M \rightarrow H \otimes M$ , called an  $H$  coaction, such that:

$$(\Delta_H \otimes id_M)(\rho) = (id_H \otimes \rho)(\rho), \quad (\epsilon_H \otimes id_M)(\rho) = id_M.$$

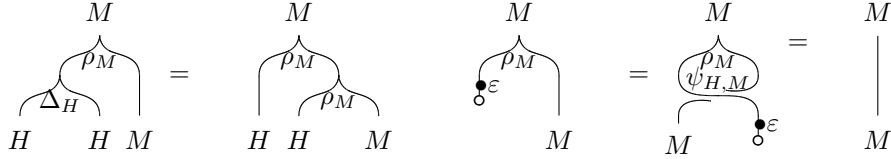

*Remark 2.12.* Let  $\mathcal{C}$  be a strict, braided, monoidal abelian category. Throughout the paper we shall use the following conventions to denote objects and morphisms of  $\mathcal{C}$ :

- $A^n$  for  $A^{\otimes n}$ ,
- $1$  for  $id$ , e.g. we write  $1_A$  or just  $1$  for  $id_A$ ,
- $(f, g)$  for  $(f \otimes g)$ ,
- $id_n$  or just  $1_n$  for  $id_{A^n}$ ,
- $1_{A,B}$  for  $1_A \otimes 1_B$ ,
- $\psi$  for  $\psi_{A,A}$ .

For example instead of writing

$$\Delta_H m_H = (m_H \otimes m_H)(id_H \otimes \psi_{H,H} \otimes id_H)(\Delta_H \otimes \Delta_H),$$

which expresses the fact that the comultiplication of a Hopf algebra is an anti-algebra map, we just write  $\Delta m = (m, m)(1, \psi, 1)(\Delta, \Delta)$ ; or instead of  $\psi_{U,U \otimes U} = (id_U \otimes \psi_{U,U})(\psi_{U,U} \otimes id_U)$ , we simply write  $\psi_{U,U^2} = (1, \psi)(\psi, 1)$  when there is no chance of confusion, and so on.

### 3. The cocyclic object of a braided triple $(H, C, M)$

In this section we extend the notion of a stable anti-Yetter-Drinfeld (SAYD) module [10, 11] to braided monoidal categories and define a cocyclic object for braided triples  $(H, C, M)$  in a *symmetric* monoidal abelian category. In the last section of this paper we treat the general non-symmetric case which is much more subtle. Recall that, by definition, in a *para-cocyclic object* all axioms of a cocyclic object are satisfied except the relations  $\tau_n^{n+1} = id$ . Given a para-cocyclic object  $X_n$ ,  $n \geq 0$  in an abelian category, we can always define a cocyclic object by considering

$$\overline{X}_n := \ker(id - \tau_n^{n+1}),$$

and restricting the faces, degeneracies, and cyclic operators to these subspaces. For general notion of cyclic and cocyclic objects we refer to [3, 5, 16]

We fix a strict, braided monoidal category  $\mathcal{C}$ , and a Hopf algebra  $H$  in  $\mathcal{C}$ . For the following definition  $\mathcal{C}$  need not be symmetric or additive.

**Definition 3.1.** A right-left braided stable anti-Yetter-Drinfeld (SAYD)  $H$ -module in  $\mathcal{C}$  is an object  $M$  in  $\mathcal{C}$  such that:

- (i)  $M$  is a right  $H$ -module via an action  $\phi_M: M \otimes H \rightarrow M$ ,

- (ii)  $M$  is a left  $H$ -comodule via a coaction  $\rho_M: M \rightarrow H \otimes M$ ,  
 (iii)  $M$  satisfies the braided anti-Yetter-Drinfeld condition, i.e.,

$$(\rho)(\phi) = [(m)(S \otimes m) \otimes \phi][(\psi_{H^{\otimes 2}, H} \otimes id_M \otimes id_H)(id_{H^{\otimes 2}} \otimes \psi_{M, H} \otimes id_H) \\ (id_{H^{\otimes 2}} \otimes id_M \otimes \psi_{H, H})(id_H \otimes \psi_{M, H} \otimes id_{H^{\otimes 2}})][\rho \otimes \Delta^2]. \quad (13)$$

- (iv)  $M$  is stable, i.e.,  $(\phi)(\psi_{H, M})(\rho) = id_M$ .

*Remark 3.2.* To deal with large expressions like (13) we break them into two lines.

The above braided SAYD conditions (iii) and (iv) in terms of braided diagrams are as follows:

$$(14)$$

**Definition 3.3.** A quadruple  $(C, \Delta_C, \epsilon_C, \phi_C)$  is called a left (braided)  $H$ -module-coalgebra in  $\mathcal{C}$  if  $(C, \Delta_C, \epsilon_C)$  is a coalgebra in  $\mathcal{C}$ , and  $C$  is a left  $H$ -module via an action  $\phi_C: H \otimes C \rightarrow C$  such that  $\phi_C$  is a coalgebra map in  $\mathcal{C}$  i.e., we have:

$$\Delta_C \phi_C = (\phi_C \otimes \phi_C)(id_H \otimes \psi_{H, C} \otimes id_C)(\Delta_H \otimes \Delta_C), \quad \epsilon_C \phi_C = \epsilon_H \otimes \epsilon_C$$

$$(15)$$

**Definition 3.4.** Let  $(C, \phi_C)$  be a left  $H$ -module. The diagonal action of  $H$  on  $C^{n+1} := C^{\otimes(n+1)}$  is defined by:

$$\phi_{C^{n+1}}: H \otimes C^{n+1} \rightarrow C^{n+1} \\ \phi_{C^{n+1}} := \underbrace{(\phi_C, \phi_C, \dots, \phi_C)}_{n+1 \text{ times}}(\mathcal{F}(\psi_{H, C}))(\Delta_H^n \otimes 1_{C^{n+1}}),$$

where,

$$\mathcal{F}(\psi_{H, C}) := \prod_{i=1}^n (id_{H^i}, \underbrace{\psi_{H, C}, \psi_{H, C}, \dots, \psi_{H, C}}_{n+1-i \text{ times}}, id_{C^i}).$$

The following is the diagrammatic version of the diagonal action:

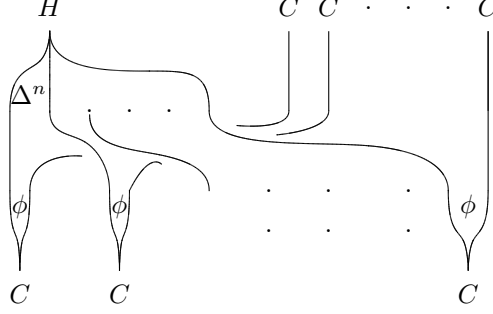

Now we are going to associate a para-cocyclic object to any triple  $(H, C, M)$ , where  $H$  is a Hopf algebra,  $C$  is an  $H$ -module coalgebra and  $M$  is a SAYD  $H$ -module, all in a symmetric monoidal category  $\mathcal{C}$ . Notice that  $\mathcal{C}$  need not be additive. For  $n \geq 0$ , let

$$C^n = C^n(C, M) := M \otimes C^{n+1}.$$

We define faces  $\delta_i: C^{n-1} \rightarrow C^n$ , degeneracies  $\sigma_i: C^{n+1} \rightarrow C^n$  and cyclic maps  $\tau_n: C^n \rightarrow C^n$  by:

$$\begin{aligned} \delta_i &= \begin{cases} (1_M, 1_{C^i}, \Delta_C, 1_{C^{n-i-1}}) & 0 \leq i < n \\ (1_M, \psi_{C, C^n})(1_M, \phi_C, 1_{C^n})(\psi_{H, M}, 1_{C^{n+1}})(\rho_M, \Delta_C, 1_{C^{n-1}}) & i = n \end{cases} \\ \sigma_i &= (1_M, 1_{C^{i+1}}, \varepsilon_C, 1_{C^{n-i}}), \quad 0 \leq i \leq n \\ \tau_n &= (1_M, \psi_{C, C^n})(1_M, \phi_C, 1_{C^n})(\psi_{H, M}, 1_{C^{n+1}})(\rho_M, 1_{C^{n+1}}) \end{aligned}$$

**Proposition 3.5.** *If  $\mathcal{C}$  is a symmetric monoidal category, then  $(C^\bullet, \delta_i, \sigma_i, \tau)$  is a para-cocyclic object in  $\mathcal{C}$ .*

The idea of the proof of this proposition is very similar to and even easier than the proof of Theorem 7.1, except that the symmetry condition is used in some steps.

Now let us assume in addition that  $\mathcal{C}$  is an *abelian* category. Recall that given a right  $H$ -module  $V$  via action  $\phi_V$ , and a left  $H$ -module  $W$  via action  $\phi_W$ , the balanced tensor product  $V \otimes_H W$  is defined as the cokernel of the map:

$$V \otimes H \otimes W \xrightarrow{(\phi_V \otimes 1_W - 1_V \otimes \phi_W)} V \otimes W.$$

We form the balanced tensor products

$$C_H^n = C_H^n(C, M) := M \otimes_H C^{n+1}, \quad n \geq 0,$$

with induced faces, degeneracies and cyclic maps denoted by  $\tilde{\delta}_i$ ,  $\tilde{\sigma}_i$  and  $\tilde{\tau}_n$ .

**Theorem 3.6.** *If  $\mathcal{C}$  is a symmetric monoidal abelian category, then  $(C_H^\bullet, \tilde{\delta}_i, \tilde{\sigma}_i, \tilde{\tau}_n)$  is a cocyclic object in  $\mathcal{C}$ .*

Some essential parts of the proof are visualized by braiding diagrams to help the reader for a better understanding of those parts involving long series of formulas.

*Proof.* The most difficult part is to show that the cyclic map  $\tilde{\tau}_n$  is well defined on  $C_H^n(C, M)$  for all  $n$ . For this, we use the following diagram:

$$\begin{array}{ccccc} M \otimes H \otimes C^{n+1} & \xrightarrow{f_{M,C^{n+1}}} & M \otimes C^{n+1} & \xrightarrow{\text{coker}(f_{M,C^{n+1}})} & M \otimes_H C^{n+1} \\ & & \downarrow \tau & & \downarrow \tilde{\tau} \\ M \otimes H \otimes C^{n+1} & \xrightarrow{f_{M,C^{n+1}}} & M \otimes C^{n+1} & \xrightarrow{\text{coker}(f_{M,C^{n+1}})} & M \otimes_H C^{n+1} \end{array}$$

where  $f_{M,C^{n+1}} = (\phi_M \otimes 1_{C^{n+1}} - 1_M \otimes \phi_{C^{n+1}})$ . So we have to show that

$$\text{coker}(f_{M,C^{n+1}})(\tau)(f_{M,C^{n+1}}) = 0,$$

i.e.,

$$\begin{aligned} \text{coker}(f_{M,C^{n+1}}) & [(1_M, \psi_{C,C^n})(1_M, \phi_C, 1_{C^n})(\psi_{H,M}, 1_{C^{n+1}}) \\ & (\rho_M, 1_{C^{n+1}})], (\phi_M \otimes 1_{C^{n+1}} - 1_M \otimes \phi_{C^{n+1}}) = 0 \quad \forall n. \end{aligned} \quad (16)$$

It is not hard to see that the equality (16) is equivalent to:

$$\begin{aligned} \text{coker}(f_{M,H^2}) & [(1_{M,H}, m_H)(1_M, \psi_{H^2,H})(\psi_{H,M}, 1_{H^2})(\rho_M, \Delta_H)] \\ & - [(1_M, \eta_H, 1_H)(\psi_{H,M})(\rho_M)(\phi_M)] = 0. \end{aligned} \quad (17)$$

From (17) to (16) one uses the diagonal action of  $H$  on  $C^{n+1}$  and the coaction of  $H$  on  $M$ . From (16) to (17) one puts  $n = 1$  and then acts both sides of (16) on  $(1_M, 1_H, \eta_H, \eta_H)$ .

If we put:

$$\alpha = [(1_{M,H}, m_H)(1_M, \psi_{H^2,H})(\psi_{H,M}, 1_{H^2})(\rho_M, \Delta_H)],$$

and

$$\beta = [(1_M, \eta_H, 1_H)(\psi_{H,M})(\rho_M)(\phi_M)],$$

then (17) becomes:

$$\text{coker}(f_{M,H^2})(\alpha - \beta) = 0.$$

To prove this equality, we will define an isomorphism

$$\tilde{\varphi}: M \otimes_H H^2 \rightarrow M \otimes_H H^2 \cong M \otimes H$$

and will show that,

$$(\tilde{\varphi}) \text{coker}(f_{M,H^2})(\alpha - \beta) = 0.$$

More explicitly:

**Step 1:** We claim that

$$\varphi := (1_H, m_H)(1_H, S_H, 1_H)(\Delta_H, 1_H): H^2 \rightarrow H^2$$

is an  $H$ -linear isomorphism, where the domain  $H^2$  is considered as an  $H$ -module via diagonal action  $(\phi_{H^2})$ , and the codomain  $H^2$  is considered as an  $H$ -module via multiplication in the first factor  $(\phi'_{H^2})$ . It is easy to see that  $\varphi$  is an isomorphism and

in fact its inverse map is  $\varphi^{-1} := (1, m)(\Delta, 1)$ . To see that  $\varphi$  is  $H$ -linear, we have to show that the following diagram commutes:

$$\begin{array}{ccc} H^2 & \xrightarrow{\varphi} & H^2 \\ \phi_{H^2} \uparrow & & \uparrow \phi'_{H^2} \\ H \otimes H^2 & \xrightarrow{1 \otimes \varphi} & H \otimes H^2 \end{array}$$

i.e., that

$$(\varphi)(\phi_{H^2}) = (\phi'_{H^2})(1, \varphi), \quad (18)$$

where  $\phi_{H^2} := (m, m)(1, \psi, 1)(\Delta, 1_{H^2})$  is the diagonal action of  $H$  on the domain  $H^2$ , and  $\phi'_{H^2} := (m, 1)$  is the other action of  $H$  on the codomain  $H^2$ . To prove that (18) is true we see that

$$RHS = (m, 1)(1, 1, m)(1, 1, S, 1)(1, \Delta, 1) = (m, m)(1, 1, S, 1)(1, \Delta, 1),$$

and

$$\begin{aligned} LHS &\stackrel{(1)}{=} (1, m)(1, S, 1)(\Delta, 1)(m, m)(1, \psi, 1)(\Delta, 1, 1) \\ &\stackrel{(2)}{=} (1, m)(1, S, 1)(1, 1, m)(\Delta m, 1, 1)(1, \psi, 1)(\Delta, 1, 1) \\ &\stackrel{(3)}{=} (1, m)(1, 1, m)(1, S, 1, 1)(m, m, 1, 1)(1, \psi, 1, 1, 1)(\Delta, \Delta, 1, 1)(1, \psi, 1)(\Delta, 1, 1) \\ &\stackrel{(4)}{=} (1, m)(1, 1, m)(m, 1, 1, 1)(1, 1, Sm, 1, 1)(1, \psi, 1, 1, 1)(\Delta, \Delta, 1, 1)(1, \psi, 1)(\Delta, 1, 1) \\ &\stackrel{(5)}{=} (1, m)(1, 1, m)(m, 1, 1, 1)(1, 1, m, 1, 1)(1, 1, S, S, 1, 1) \\ &\quad (1, 1, \psi, 1, 1)(1, \psi, 1, 1, 1)(\Delta, \Delta, 1, 1)(1, \psi, 1)(\Delta, 1, 1) \\ &\stackrel{(6)}{=} (1, m)(1, 1, m)(m, 1, 1, 1)(1, 1, m, 1, 1)(1, 1, S, S, 1, 1) \\ &\quad (1, \psi_{H, H^2}, 1, 1)(1, 1, \Delta, 1, 1)(\Delta, 1, 1, 1)(1, \psi, 1)(\Delta, 1, 1) \\ &\stackrel{(7)}{=} (1, m)(1, 1, m)(m, 1, 1, 1)(1, 1, m, 1, 1)(1, 1, S, S, 1, 1) \\ &\quad (1, \Delta, 1, 1, 1)(1, \psi, 1, 1)(1, 1, \psi, 1)(\Delta, 1, 1, 1)(\Delta, 1, 1) \\ &\stackrel{(8)}{=} (1, m)(1, 1, m)(m, 1, 1, 1)(1, 1, m, 1, 1)(1, 1, S, S, 1, 1) \\ &\quad (1, \Delta, 1, 1, 1)(1, \psi_{H^2, H})(1, \Delta, 1, 1)(\Delta, 1, 1) \\ &\stackrel{(9)}{=} (1, m)(1, 1, m)(m, 1, 1, 1)(1, 1, m, 1, 1)(1, 1, S, S, 1, 1) \\ &\quad (1, \Delta, 1, 1, 1)(1, 1, \Delta, 1)(1, \psi, 1)(\Delta, 1, 1) \\ &\stackrel{(10)}{=} (1, m)(m, 1, 1)(1, 1, 1, m)(1, 1, 1, m, 1)(1, 1, S, S, 1, 1) \\ &\quad (1, 1, 1, \Delta, 1)(1, \Delta, 1, 1)(1, \psi, 1)(\Delta, 1, 1) \\ &\stackrel{(11)}{=} (1, m)(m, 1, 1)(1, 1, 1, m)(1, 1, S, m(S, 1)\Delta, 1)(1, \Delta, 1, 1)(1, \psi, 1)(\Delta, 1, 1) \\ &\stackrel{(12)}{=} (1, m)(m, 1, 1)(1, 1, 1, m)(1, 1, S, \eta, 1)(1, 1, 1, \varepsilon, 1)(1, \Delta, 1, 1)(1, \psi, 1)(\Delta, 1, 1) \\ &\stackrel{(13)}{=} (1, m)(m, 1, 1)(1, 1, 1, S, m(\eta, 1))(1, \Delta, 1)(1, 1, \varepsilon, 1)(1, \psi, 1)(\Delta, 1, 1) \end{aligned}$$

$$\begin{aligned}
& \stackrel{(14)}{=} (m, m)(1, 1, S, 1)(1, \Delta, 1)(1, \varepsilon, 1, 1)(\Delta, 1, 1) \\
& = (m, m)(1, 1, S, 1)(1, \Delta, 1)((1, \varepsilon)\Delta, 1, 1) \\
& \stackrel{(15)}{=} (m, m)(1, 1, S, 1)(1, \Delta, 1)
\end{aligned}$$

Therefore  $LHS = RHS$ . Stages (1) to (15) are explained below:

- (1) We use definitions  $\varphi = (1, m)(1, S, 1)(\Delta, 1)$  and  $\phi_{H^2} = (m, m)(1, \psi, 1)(\Delta, 1_{H^2})$ .
- (2) We use  $(m, m) = (1, m)(m, 1, 1)$ , commute  $(1, m)$  and  $(\Delta, 1)$ , i.e.,  $(\Delta, 1)(1, m) = (1, 1, m)(\Delta, 1, 1)$ , and then use  $(\Delta, 1, 1)(m, 1, 1) = (\Delta m, 1, 1)$ .
- (3) We commute  $(1, S, 1)$  and  $(1, 1, m)$ , and use

$$\Delta m = (m \otimes m)(id \otimes \psi \otimes id)(\Delta \otimes \Delta).$$

- (4) We use  $(m, m, 1, 1) = (m, 1, 1, 1)(1, 1, m, 1, 1)$ , then commute  $(m, 1, 1, 1)$  and  $(1, S, 1, 1)$ , and then compose  $(1, 1, m, 1, 1)$  with  $(1, 1, S, 1, 1)$ .
- (5) We use  $Sm = m(S, S)\psi$ .
- (6) We use  $\psi_{H, H^2} = (1, \psi)(\psi, 1)$  and  $(\Delta, \Delta, 1, 1) = (1, 1, \Delta, 1, 1)(\Delta, 1, 1, 1)$ .
- (7) We use the naturality of  $\psi$  to commute  $(1, \psi_{H, H^2}, 1, 1)$  and  $(1, 1, \Delta, 1, 1)$ ; more explicitly, we use the following commuting diagram:

$$\begin{array}{ccc}
H^2 & \xrightarrow{(1, \Delta)} & H \otimes H^2 \\
\psi \downarrow & & \downarrow \psi_{H, H^2} \\
H^2 & \xrightarrow{(\Delta, 1)} & H^2 \otimes H
\end{array}$$

Also we commute  $(\Delta, 1, 1, 1)$  and  $(1, \psi, 1)$ , i.e., we use  $(\Delta, 1, 1, 1)(1, \psi, 1) = (1, 1, \psi, 1)(\Delta, 1, 1, 1)$ .

- (8) We use  $\psi_{H^2, H} = (\psi, 1)(1, \psi)$  and the coassociativity  $(\Delta, 1)\Delta = (1, \Delta)\Delta$ .
- (9) We commute  $(1, \psi_{H^2, H})$  and  $(1, \Delta, 1, 1)$  using the naturality of  $\psi$  as in step (7).
- (10) We use simple commutations and the associativity  $m(1, m) = m(m, 1)$ , in four first parenthesis, also commute  $(1, \Delta, 1, 1, 1)$  and  $(1, 1, \Delta, 1)$ .
- (11) We use  $(1, 1, 1, m, 1)(1, 1, S, S, 1, 1)(1, 1, 1, \Delta, 1) = (1, 1, S, m(S, 1)\Delta, 1)$ .
- (12) We use  $m(S, 1)\Delta = \eta\varepsilon$ .
- (13) We use  $(1, 1, 1, \varepsilon, 1)(1, \Delta, 1, 1) = (1, \Delta, 1)(1, 1, \varepsilon, 1)$ .
- (14) We use  $m(\eta, 1) = 1$ , also commute  $(1, 1, \varepsilon, 1)$  and  $(1, \psi, 1)$  using naturality of  $\psi$ .

In fact we use this commuting diagram:

$$\begin{array}{ccc}
H^2 & \xrightarrow{(\varepsilon, 1)} & I \otimes H \\
\psi \downarrow & & \downarrow \psi_{I, H} = id_I \\
H^2 & \xrightarrow{(1, \varepsilon)} & H \otimes I
\end{array}$$

- (15) We use  $(1, \varepsilon)\Delta = 1$ .

**Step 2:** Considering  $1_M: M \rightarrow M$  as an  $H$ -linear isomorphism we have  $1_M \otimes \varphi: M \otimes H^2 \cong M \otimes H^2$  and so we have:

$$\tilde{\varphi} := 1_M \otimes_H \varphi: M \otimes_H H^2 \cong M \otimes_H H^2 \cong (M \otimes_H H) \otimes H \cong M \otimes H \quad (19)$$

**Step 3:** Now we prove that  $(\tilde{\varphi}) \operatorname{coker}(f_{M,H^2})(\alpha - \beta) = 0$ . For that, we look at this commuting diagram

$$\begin{array}{ccccc} M \otimes H \otimes H^2 & \xrightarrow{f_{M,H^2}} & M \otimes H^2 & \xrightarrow{\operatorname{coker}(f_{M,H^2})} & M \otimes_H H^2 \\ & & \downarrow 1_M \otimes \varphi & & \downarrow \tilde{\varphi} \\ M \otimes H \otimes H^2 & \xrightarrow{f'_{M,H^2}} & M \otimes H^2 & \xrightarrow{\operatorname{coker}(f'_{M,H^2})} & M \otimes_H H^2 \end{array}$$

where  $f_{M,H^2} = (\phi_M \otimes 1_{H^2} - 1_M \otimes \phi_{H^2})$  and  $f'_{M,H^2} = (\phi_M \otimes 1_{H^2} - 1_M \otimes \phi'_{H^2})$ . This shows that  $(\tilde{\varphi})(\operatorname{coker}(f)) = (\operatorname{coker}(f'))(1_M \otimes \varphi)$ , so we instead will prove that  $(\operatorname{coker}(f'))(1_M \otimes \varphi)(\alpha - \beta) = 0$ , i.e.,

$$(\operatorname{coker}(f'))(1_M \otimes \varphi)(\alpha) = (\operatorname{coker}(f'))(1_M \otimes \varphi)(\beta). \quad (20)$$

The LHS of (20) is equal to:

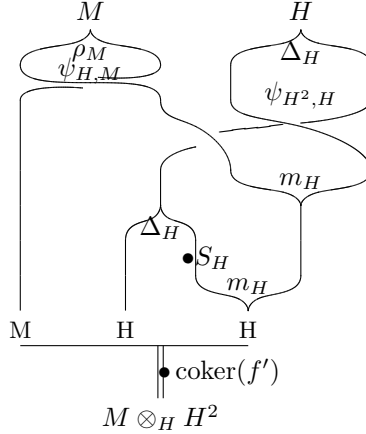

$$\begin{aligned} &\stackrel{(1)}{=} (\operatorname{coker}(f'))(1_M, 1, m)(1_M, 1, S, 1)(1_M, \Delta, 1)(1_M, 1, m) \\ &\quad (1_M, \psi_{H^2, H})(\psi_{H, M}, 1, 1)(\rho, \Delta) \\ &\stackrel{(2)}{=} (\operatorname{coker}(f'))(1_M, 1, m)(1_M, 1, S, 1)(1_M, \Delta, 1)(1_M, \psi)(1_M, m, 1)(\psi_{H, M}, 1, 1)(\rho, \Delta) \\ &\stackrel{(3)}{=} (\operatorname{coker}(f'))(1_M, 1, m)(1_M, 1, S, 1)(1_M, \psi_{H, H^2})(1_M, 1, \Delta)(1_M, m, 1) \\ &\quad (\psi_{H, M}, 1, 1)(\rho, \Delta) \\ &\stackrel{(4)}{=} (\operatorname{coker}(f'))(1_M, 1, m)(1_M, 1, S, 1)(1_M, \psi_{H, H^2})(1_M, m, 1, 1)(\psi_{H, M}, 1, 1, 1) \\ &\quad (1, 1_M, 1, \Delta)(\rho, \Delta) \\ &\stackrel{(5)}{=} (\operatorname{coker}(f'))(1_M, 1, m)(1_M, 1, S, 1)(1_M, 1, 1, m)(1_M, \psi_{H^2, H^2})(\psi_{H, M}, 1, 1, 1)(\rho \Delta^2) \\ &\stackrel{(6)}{=} (\operatorname{coker}(f'))(1_M, 1, m(S, m))(1_M, \psi_{H^2, H^2})(\psi_{H, M}, 1, 1, 1)(\rho, \Delta^2) \end{aligned}$$

$$\begin{aligned} &\stackrel{(7)}{=} (\text{coker}(f')) (1_M, m(1, \eta), m(S, m))(1_M, \psi_{H^2, H^2})(\psi_{H, M}, 1, 1, 1)(\rho, \Delta^2) \\ &\stackrel{(8)}{=} (\text{coker}(f')) (1_M, m, 1)(1_M, 1, \eta, 1)(1_M, 1, m(S, m))(1_M, \psi_{H^2, H^2}) \\ &\quad (\psi_{H, M}, 1, 1, 1)(\rho, \Delta^2) \\ &\stackrel{(9)}{=} (\text{coker}(f')) (1_M, \phi'_{H^2})(1_M, 1, \eta, 1)(1_M, 1, m(S, m))(1_M, \psi_{H^2, H^2}) \\ &\quad (\psi_{H, M}, 1, 1, 1)(\rho, \Delta^2) \\ &\stackrel{(10)}{=} (\text{coker}(f')) (\phi_M, 1, 1)(1_M, 1, \eta, 1)(1_M, 1, m(S, m)) \\ &\quad \underbrace{(1_M, \psi_{H^2, H^2})(\psi_{H, M}, 1, 1, 1)}_{\text{Diagram}} (\rho, \Delta^2) \end{aligned} \tag{21}$$

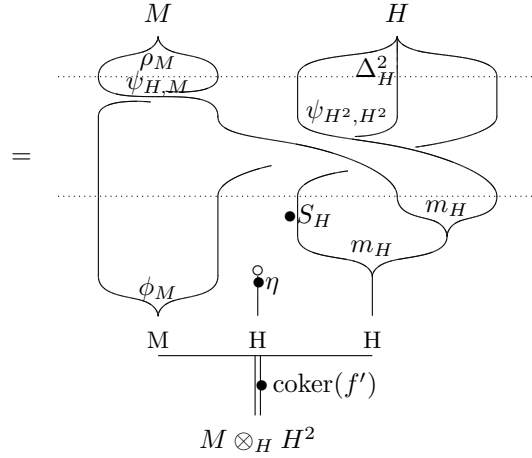

Stages (1) to (10) are explained below with (10) perhaps the most important one:

(1) We use  $\varphi = (1, m)(1, S, 1)(\Delta, 1)$  and

$$\alpha = [(1_{M, H}, m_H)(1_M, \psi_{H^2, H})(\psi_{H, M}, 1_{H^2})(\rho, \Delta)].$$

(2) We use the naturality of  $\psi$  to commute  $(1_M, 1, m)$  and  $(1_M, \psi_{H^2, H})$ , i.e., we use the diagram:

$$\begin{array}{ccc} H^2 \otimes H & \xrightarrow{(m, 1)} & H^2 \\ \psi_{H, H^2} \downarrow & & \downarrow \psi \\ H \otimes H^2 & \xrightarrow{(1, m)} & H^2 \end{array}$$

(3) We commute  $(1_M, \Delta, 1)$  and  $(1_M, \psi)$ , again using naturality of  $\psi$ :

$$\begin{array}{ccc} H^2 & \xrightarrow{(1, \Delta)} & H \otimes H^2 \\ \psi \downarrow & & \downarrow \psi_{H, H^2} \\ H^2 & \xrightarrow{(\Delta, 1)} & H^2 \otimes H \end{array}$$

(4) We commute  $(1_M, 1, \Delta)$  first with  $(1_M, m, 1)$  and next with  $(\psi_{H, M}, 1, 1)$ .



(5) We commute  $(1_M, \psi_{H, H^2})$  and  $(1_M, m, 1, 1)$  using the diagram:

$$\begin{array}{ccc} H^2 \otimes H^2 & \xrightarrow{(m, 1, 1)} & H \otimes H^2 \\ \psi_{H^2, H^2} \downarrow & & \downarrow \psi_{H, H^2} \\ H^2 \otimes H^2 & \xrightarrow{(1, 1, m)} & H^2 \otimes H \end{array}$$

Also we use  $(1, 1_M, 1, \Delta)(\rho, \Delta) = (\rho, \Delta^2)$  and use the definition  $\Delta^2 := (1, \Delta)\Delta$ .

(6) We use  $(1_M, 1, m)(1_M, 1, S, 1)(1_M, 1, 1, m) = (1_M, 1, m(S, m))$ .

(7) We use  $1 = m(1, \eta)$ .

(8) We use  $(1_M, m(1, \eta), m(S, m)) = (1_M, m, 1)(1_M, 1, \eta, 1)(1_M, 1, m(S, m))$ .

(9) We use the definition  $\phi'_{H^2} = (m, 1)$ .

(10) We use  $\text{coker}(f')(1_M, \phi'_{H^2}) = \text{coker}(f')(\phi_M, 1, 1)$ , which comes from the definition of cokernel and this diagram:

$$M \otimes H \otimes H^2 \xrightarrow{f'_{M, H^2} = (\phi_M \otimes 1_{H^2} - 1_M \otimes \phi'_{H^2})} M \otimes H^2 \xrightarrow{\text{coker}(f')} M \otimes_H H^2$$

The RHS of (20) is equal to:

$$\begin{aligned} &\stackrel{(1)}{=} (\text{coker}(f'))(1_M, 1, m)(1_M, 1, S, 1)(1_M, \Delta, 1)(1_M, \eta, 1)(\psi_{H, M})(\rho)(\phi) \\ &\stackrel{(2)}{=} (\text{coker}(f'))(1_M, 1, m)(1_M, 1, S, 1)(1_M, \eta, \eta, 1)(\psi_{H, M})(\rho)(\phi) \\ &\stackrel{(3)}{=} (\text{coker}(f'))(1_M, 1, m)(1_M, \eta, \eta, 1)(\psi_{H, M})(\rho)(\phi) \\ &\stackrel{(4)}{=} (\text{coker}(f'))(1_M, \eta, 1)(\psi_{H, M})(\rho)(\phi) \end{aligned}$$

$$= \begin{array}{c} \begin{array}{ccc} M & & H \\ \text{---} & \phi_M & \text{---} \\ \text{---} & \rho_M & \text{---} \\ \text{---} & \psi_{H, M} & \text{---} \\ \text{---} & \circlearrowleft \eta & \text{---} \\ M & & H \\ \text{---} & & \text{---} \\ \bullet & \text{coker}(f') & \\ \text{---} & & \text{---} \\ M \otimes_H H^2 & & \end{array} \\ \stackrel{(14)}{=} \begin{array}{ccc} M & & H \\ \text{---} & \rho_M & \text{---} \\ \text{---} & \psi_{M, H} & \text{---} \\ \text{---} & \Delta_H^2 & \text{---} \\ \text{---} & \psi_{H, H} & \text{---} \\ \text{---} & \psi_{M, H} & \text{---} \\ \text{---} & \psi_{H^2, H} & \text{---} \\ \text{---} & \psi_{M, H} & \text{---} \\ \text{---} & \psi_{H, M} & \text{---} \\ \text{---} & \phi_M & \text{---} \\ \bullet & S_H & \\ \text{---} & m_H & \text{---} \\ \text{---} & m_H & \text{---} \\ \text{---} & \psi_{H, M} & \text{---} \\ \text{---} & \circlearrowleft \eta & \text{---} \\ M & & H \\ \text{---} & & \text{---} \\ \bullet & \text{coker}(f') & \\ \text{---} & & \text{---} \\ M \otimes_H H^2 & & \end{array} \end{array} \quad (22)$$

$$\begin{aligned}
&\stackrel{(5)}{=} (\text{coker}(f')) (1_M, \eta, 1)(\psi_{H,M}) (m(S, m), \phi)(\psi_{H^2,H}, 1_M, 1)(1, 1, \psi_{M,H}, 1) \\
&\quad (1, 1, 1_M, \psi)(1, \psi_{M,H}, 1, 1)(\rho, \Delta^2) \\
&\stackrel{(6)}{=} (\text{coker}(f')) (1_M, \eta, 1)(\psi_{H,M}) (1, \phi)(m(S, m), 1_M, 1)(\psi_{H^2,H}, 1_M, 1)(1, 1, \psi_{M,H}, 1) \\
&\quad (1, 1, 1_M, \psi)(1, \psi_{M,H}, 1, 1)(\rho, \Delta^2) \\
&\stackrel{(7)}{=} (\text{coker}(f')) (1_M, \eta, 1)(\phi, 1)(\psi_{H,M \otimes H})(m(S, m), 1_M, 1)(\psi_{H^2,H}, 1_M, 1) \\
&\quad (1, 1, \psi_{M,H}, 1)(1, 1, 1_M, \psi)(1, \psi_{M,H}, 1, 1)(\rho, \Delta^2) \\
&\stackrel{(8)}{=} (\text{coker}(f')) (1_M, \eta, 1)(\phi, 1)(1_M, 1, m(S, m))(\psi_{H^3, M \otimes H})(\psi_{H^2,H}, 1_M, 1) \\
&\quad (1, 1, \psi_{M,H}, 1)(1, 1, 1_M, \psi)(1, \psi_{M,H}, 1, 1)(\rho, \Delta^2) \\
&\stackrel{(9)}{=} (\text{coker}(f')) (\phi, 1, 1)(1_M, 1, \eta, 1)(1_M, 1, m(S, m)) \\
&\quad \underbrace{(\psi_{H^3, M \otimes H})(\psi_{H^2,H}, 1_M, 1)(1, 1, \psi_{M,H}, 1)(1, 1, 1_M, \psi)(1, \psi_{M,H}, 1, 1)}_{(\rho, \Delta^2)}
\end{aligned}$$

$$\begin{array}{c}
\begin{array}{ccc}
M & & H \\
\left. \begin{array}{c} \rho_M \\ \psi_{M,H} \\ \psi_{H^2,H} \\ \psi_{H^3, M \otimes H} \end{array} \right\} & & \left. \begin{array}{c} \Delta_H^2 \\ \psi_{H,H} \\ \psi_{M,H} \end{array} \right\} \\
\hline
\end{array} \\
= \\
\begin{array}{ccc}
\left. \begin{array}{c} \phi_M \\ \eta \\ \text{coker}(f') \end{array} \right\} & & \left. \begin{array}{c} S_H \\ m_H \end{array} \right\} \\
\hline
M & H & H \\
\hline
M \otimes_H H^2
\end{array}
\end{array} \tag{23}$$

Stages (1) to (9) are explained below. Notice that as is shown in picture (22), in stage (5) the braided AYD condition (14) is used.

(1) We just use the definitions of  $\varphi = (1, m)(1, S, 1)(\Delta, 1)$  and,

$$\beta = [(1_M, \eta, 1)(\psi_{H,M})(\rho)(\phi)].$$

(2) We use  $(1_M, \Delta, 1)(1_M, \eta, 1) = (1_M, \Delta\eta, 1)$  and  $\Delta\eta = \eta \otimes \eta$ .

- (3) We use  $(1_M, 1, S, 1)(1_M, \eta, \eta, 1) = (1_M, \eta, S\eta, 1)$  and  $S\eta = \eta$ .
- (4) We use  $(1_M, 1, m)(1_M, \eta, \eta, 1) = (1_M, \eta, m(\eta, 1))$  and  $m(\eta, 1) = 1$ .
- (5) We use the AYD formula (14).
- (6) We use  $(m(S, m), \phi) = (1, \phi)(m(S, m), 1_M, 1)$ .
- (7) We commute  $(\psi_{H,M})$  and  $(1, \phi)$  using:

$$\begin{array}{ccc} H \otimes (M \otimes H) & \xrightarrow{(1, \phi)} & H \otimes M \\ \psi_{H, M \otimes H} \downarrow & & \downarrow \psi_{H, M} \\ (M \otimes H) \otimes H & \xrightarrow{(\phi, 1)} & M \otimes H \end{array}$$

- (8) We commute  $(\psi_{H, M \otimes H})$  and  $(m(S, m), 1_M, 1)$  using:

$$\begin{array}{ccc} H^3 \otimes (M \otimes H) & \xrightarrow{(m(S, m), 1_M, 1)} & H \otimes (M \otimes H) \\ \psi_{H^3, M \otimes H} \downarrow & & \downarrow \psi_{H, M \otimes H} \\ (M \otimes H) \otimes H^3 & \xrightarrow{(1_M, 1, m(S, m))} & (M \otimes H) \otimes H \end{array}$$

- (9) We commute  $(1_M, \eta, 1)$  and  $(\phi, 1)$ .

Thus, LHS = RHS in (20) if:

$$\begin{aligned} (\psi_{H^3, M \otimes H})(\psi_{H^2, H}, 1_M, 1)(1, 1, \psi_{M, H}, 1)(1, 1, 1_M, \psi)(1, \psi_{M, H}, 1, 1) \\ = (1_M, \psi_{H^2, H^2})(\psi_{H, M}, 1, 1, 1), \end{aligned}$$

i.e., if in diagrams (21) and (23), the parts between dotted lines are equal. This is true since:

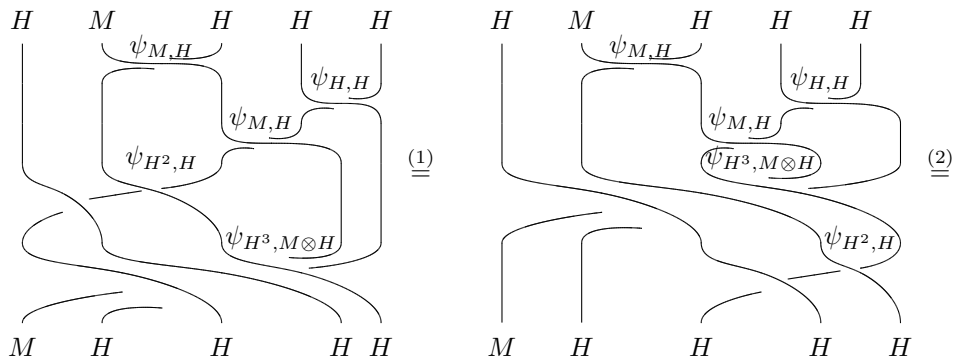

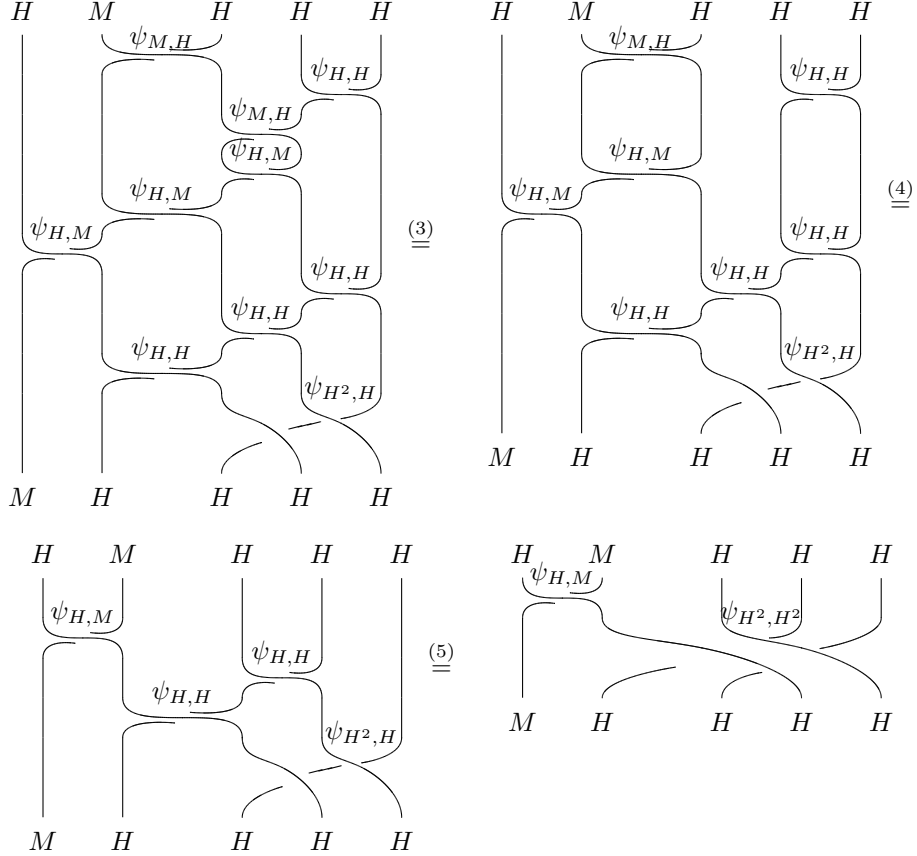

Stages (1) to (5) are explained below. Notice that in stages (3), (4) the symmetry condition  $\psi^2 = id$  is used.

- (1) We commute  $(\psi_{H^3, M \otimes H})$  and  $(\psi_{H^2, H}, 1_M, 1)$  using naturality of  $\psi$ :

$$\begin{array}{ccc} H^3 \otimes (M \otimes H) & \xrightarrow{(\psi_{H^2, H}, 1_M, 1)} & H^3 \otimes (M \otimes H) \\ \psi_{H^3, M \otimes H} \downarrow & & \downarrow \psi_{H^3, M \otimes H} \\ (M \otimes H) \otimes H^3 & \xrightarrow{(1_M, 1, \psi_{H^2, H})} & (M \otimes H) \otimes H^3 \end{array}$$

- (2) We use

$$\begin{aligned} (\psi_{H^3, M \otimes H}) &= (1_M, \psi_{H, H}, 1, 1)(1_M, 1, \psi_{H, H}, 1)(1_M, 1, 1, \psi_{H, H}) \\ &\quad (\psi_{H, M}, 1, 1, 1)(1, \psi_{H, M}, 1, 1)(1, 1, \psi_{H, M}, 1) \end{aligned}$$

- (3) We use the symmetric property of  $\psi$  to put  $\psi_{H, M} \psi_{M, H} = 1$ .  
(4) We use the symmetric property of  $\psi$  to put  $\psi_{H, M} \psi_{M, H} = 1$  and  $\psi_{H, H} \psi_{H, H} = 1$ .  
(5) We use  $\psi_{H^2, H^2} = (1, \psi_{H^2, H})(\psi_{H, H}, 1, 1)(1, \psi_{H, H}, 1)$ .

As for the cyclic condition, considering the following diagram:

$$\begin{array}{ccccc}
 M \otimes H \otimes C^{n+1} & \xrightarrow{f_{M,C^{n+1}}} & M \otimes C^{n+1} & \xrightarrow{\text{coker}(f_{M,C^{n+1}})} & M \otimes_H C^{n+1} \\
 & & \downarrow \tau & & \downarrow \tilde{\tau} \\
 M \otimes H \otimes C^{n+1} & \xrightarrow{f_{M,C^{n+1}}} & M \otimes C^{n+1} & \xrightarrow{\text{coker}(f_{M,C^{n+1}})} & M \otimes_H C^{n+1}
 \end{array}$$

where  $f_{M,C^{n+1}} = (\phi_M \otimes 1_{C^{n+1}} - 1_M \otimes \phi_{C^{n+1}})$ , and using the definition of cokernel, it can be verified that:

$$\begin{aligned}
 (\tilde{\tau}_n^{n+1})\text{coker}(f_{M,C^{n+1}}) &= \text{coker}(f_{M,C^{n+1}})(\tau_n^{n+1}) \\
 &= \text{coker}(f_{M,C^{n+1}})(1_M \otimes \phi_{C^{n+1}})(\psi_{H,M}\rho_M \otimes 1_{C^{n+1}}) \\
 &= \text{coker}(f_{M,C^{n+1}})(\phi_M \otimes 1_{C^{n+1}})(\psi_{H,M}\rho_M \otimes 1_{C^{n+1}}) \\
 &= \text{coker}(f_{M,C^{n+1}})(\phi_M \psi_{H,M}\rho_M \otimes 1_{C^{n+1}}).
 \end{aligned}$$

Now using the stability property of  $M$ ,  $(\phi_M)(\psi_{H,M})(\rho_M) = 1_M$ , and the universal property of cokernel it is clear that:

$$\tilde{\tau}_n^{n+1} = id.$$

Also the other properties of a cocyclic object can be easily checked. This finishes the proof of Theorem 3.6.  $\square$

*Example 3.7.* As a special case, if we put  $C = H$  as an  $H$ -module coalgebra over itself, we obtain a braided version of Connes-Moscovici's Hopf cyclic theory [6, 7, 8] in any symmetric monoidal abelian category. We shall explain this example in more detail in the next section.

#### 4. The braided version of Connes-Moscovici's Hopf cyclic cohomology

Let  $\mathcal{C}$  be a strict braided monoidal category and  $(H, \Delta, \varepsilon, m, \eta, S)$  be a Hopf algebra in  $\mathcal{C}$ . Notice that, except for Theorem 4.7,  $\mathcal{C}$  is not assumed to be symmetric or additive.

**Definition 4.1.** A character for  $H$  is a morphism  $\delta: H \rightarrow I$  in  $\mathcal{C}$  which is an algebra map, i.e.:

$$\delta m = \delta \otimes \delta \quad \text{and} \quad \delta \eta = id_I.$$

A co-character for  $H$  is a morphism  $\sigma: I \rightarrow H$  which is a coalgebra map, i.e.:

$$\Delta \sigma = \sigma \otimes \sigma \quad \text{and} \quad \varepsilon \sigma = id_I.$$

A pair  $(\delta, \sigma)$  consisting of a character and a co-character is called a braided modular pair if:

$$\delta \sigma = id_I.$$

**Definition 4.2.** If  $\delta$  is a character for  $H$ , the corresponding  $\delta$ -twisted antipode  $\tilde{S}$  is defined by:

$$\tilde{S} := (\delta \otimes S)\Delta. \tag{24}$$

**Proposition 4.3.** If  $\tilde{S}$  is a  $\delta$ -twisted antipode for  $H$  then we have:

$$\tilde{S}m = m\psi(\tilde{S} \otimes \tilde{S}) = m(\tilde{S} \otimes \tilde{S})\psi,$$

$$\tilde{S}\eta = \eta, \tag{25}$$

$$\Delta\tilde{S} = \psi(\tilde{S} \otimes S)\Delta = (S \otimes \tilde{S})\psi\Delta,$$

$$\tag{26}$$

$$\varepsilon\tilde{S} = \delta, \quad \delta\tilde{S} = \varepsilon, \quad \tilde{S}\sigma = S\sigma,$$

$$m(\tilde{S}\sigma \otimes \sigma) = m(S\sigma \otimes \sigma) = \eta. \tag{27}$$

*Proof.* Here we give a diagrammatic proof of the relation (25). Other relations can be easily proved with the same method.

In the first identity we used the definition of  $\tilde{S}$ , relation (24). In the second one we used relation (6), and in the third one relations (7) (replacing  $\varepsilon$  by  $\delta$ ) and (10). In the fourth identity, the naturality of  $\psi$ , relation (3), is used. In the fifth identity again the definition of  $\tilde{S}$ , relation (24), is used and in the last identity the naturality of  $\psi$ , relation (1), is used.  $\square$

**Definition 4.4.** A modular pair  $(\delta, \sigma)$  for  $H$  is called a braided modular pair in involution (BMPI) if:

$$m((m \otimes id)(S\sigma \otimes \tilde{S}^2 \otimes \sigma)) = id.$$

Considering the fact that  $S\sigma = \tilde{S}\sigma$ , the BMPI condition can be shown by the following diagram.

*Example 4.5.* One can easily check that, if  $I$  is considered as a right  $H$ -module via a character  $\delta$ :

$$\phi_I = \delta: I \otimes H = H \rightarrow I,$$

and as a left  $H$ -comodule via a co-character  $\sigma$ :

$$\rho_I = \sigma: I \rightarrow H \otimes I = I,$$

then  $I$  is a braided SAYD module over  $H$  if and only if  $(\delta, \sigma)$  is a braided MPI. We denote this SAYD module by  ${}^\sigma I_\delta$ .

*Example 4.6.* If  $H$  is a Hopf algebra in  $Vect_{\mathbb{C}}$ , then the above definitions reduce to those of Connes-Moscovici [6, 7, 8].

Now we are ready to give a braided version of Connes-Moscovici’s Hopf cyclic theory.

**Theorem 4.7.** *Suppose  $(H, (\delta, \sigma))$  is a braided Hopf algebra in a symmetric braided monoidal abelian category  $\mathcal{C}$ , where  $(\delta, \sigma)$  is a braided MPI. If we put*

$$(C; \phi_C, \Delta_C) = (H; m_H, \Delta_H),$$

and

$$M = {}^\sigma I_\delta,$$

then the cocyclic object of Theorem 3.6 reduces to the following one which is a braided version of Connes-Moscovici's Hopf cyclic theory:

$$C^0(H) = I \quad \text{and} \quad C^n(H) = H^n, \quad n \geq 1,$$

with faces, degeneracies, and cyclic maps given by:

$$\delta_i = \begin{cases} (\eta, 1, 1, \dots, 1) & i = 0 \\ (1, 1, \dots, 1, \underset{i\text{-th}}{\Delta}, 1, 1, \dots, 1) & 1 \leq i \leq n - 1 \\ (1, 1, \dots, 1, \sigma) & i = n \end{cases}$$

$$\sigma_i = (1, 1, \dots, \underset{(i+1)\text{-th}}{\varepsilon}, 1, 1, \dots, 1), \quad 0 \leq i \leq n$$

$$\tau_n = \begin{cases} id_I & n = 0 \\ (m_n)(\Delta^{n-1} \tilde{S}, 1_{H^{n-1}}, \sigma) & n \neq 0. \end{cases}$$

Here by  $m_n$  we mean,  $m_1 = m$ , and for  $n \geq 2$ :

$$m_n = m_{H^n} = \underbrace{(m, m, \dots, m)}_{n \text{ times}} \mathcal{F}_n(\psi),$$

where

$$\mathcal{F}_n(\psi) := \prod_{j=1}^{n-1} (1_{H^j}, \underbrace{\psi, \psi, \dots, \psi}_{n-j \text{ times}}, 1_{H^j}).$$

For example for  $n = 2, 3$ ,  $\tau_2$  and  $\tau_3$  are as follows:

$$\begin{aligned} \tau_2 &= (m_2)(\Delta \tilde{S}, 1, \sigma) \\ &= (m, m)(1, \psi, 1)((S, \tilde{S})\psi \Delta, 1, \sigma) = (m, m)(1, \psi, 1)(\psi(\tilde{S}, S)\Delta, 1, \sigma) \end{aligned}$$

(29)



$$\begin{aligned}
 \tau_3 &= (m_3)(\Delta^2 \tilde{S}, 1, 1, \sigma) \\
 &= (m, m, m)(1, \psi, 3)(3, \psi, 1)(2, \psi, 2)((S, S, \tilde{S})(1, \psi)(\psi, 1)(1, \psi)\Delta^2, 1, 1, \sigma) \\
 &\stackrel{(1)}{=} (m, m, m)(S, 1, S, 1, \tilde{S}, \sigma)(1, \psi, 2)(3, \psi)(2, \psi, 1)(1, \psi, 2)(\psi, 3)(1, \psi, 2)(\Delta^2, 2)
 \end{aligned}$$

*Remark 4.8.* In Section 7 we discuss the analogue of this theorem in a non-symmetric braided monoidal abelian category.

*Remark 4.9.* One can define the notions of  $H$ -module algebra and  $\delta$ -invariant  $\sigma$ -trace and define a characteristic map as in [6, 7, 8].

*Example 4.10.* (Connes-Moscovici's theory) If one puts  $\mathcal{C} = \text{Vect}_{\mathbb{C}}$  and  $I = \mathbb{C}$ , then the above formulas reduce to those in [6, 7, 8].

As another example of the above theory, we devote Section 5 to provide a Hopf cyclic theory for super Hopf algebras. But before that we give some more results here:

**Lemma 4.11.** *If  $H$  is commutative in the sense that  $m\psi = m$  or cocommutative in the sense that  $\Delta = \psi\Delta$ , then  $S^2 = id$  and thus  $(\varepsilon, 1)$  is an MPI for  $H$ .*

*Proof.* We have:

$$\begin{aligned}
 1 &= id_H \stackrel{(1)}{=} m(\eta, 1)(\varepsilon, 1)\Delta = m(\eta\varepsilon, 1)\Delta \\
 &\stackrel{(2)}{=} m(S\eta\varepsilon, 1)\Delta = m(S(m(1, S)\Delta, 1)\Delta \\
 &\stackrel{(3)}{=} m(m(S, S)\psi(1, S)\Delta, 1)\Delta = m(m(S^2, S)\psi\Delta, 1)\Delta \\
 &\stackrel{(4)}{=} m(m(S^2, S)\Delta, 1)\Delta = m(m, 1)(S^2, S, 1)(\Delta, 1)\Delta \\
 &\stackrel{(5)}{=} m(1, m)(S^2, S, 1)(1, \Delta)\Delta = m(S^2, m(S, 1)\Delta)\Delta = m(S^2, \eta\varepsilon)\Delta \\
 &= m(1, \eta)(S^2, 1_I)(1, \varepsilon)\Delta = (S^2, 1_I) \\
 &\stackrel{(6)}{=} S^2
 \end{aligned}$$

Stages (1) to (6) are explained below:

- (1) We use  $(\varepsilon, 1)\Delta = m(\eta, 1) = 1$ .
- (2) We use  $S\eta = \eta$  and  $m(1, S)\Delta = \eta\varepsilon$ .
- (3) We use  $Sm = m(S, S)\psi$ , commute  $\psi$  and  $(1, S)$  using the naturality of  $\psi$ , and use  $(S, S)(S, 1) = (S^2, S)$ .
- (4) In the commutative case we first use  $(S, S)\psi = \psi(S, S)$  and then use  $m\psi = m$ . In the cocommutative case we use  $\Delta = \psi\Delta$ , and then  $(m(S^2, S)\Delta, 1) = (m, 1)(S^2, S, 1)(\Delta, 1)$ .
- (5) We use  $m(m, 1) = m(1, m)$ ,  $(\Delta, 1)\Delta = (1, \Delta)\Delta$ , and  $m(S, 1)\Delta = \eta\varepsilon$ .
- (6) We use  $(\varepsilon, 1)\Delta = m(\eta, 1) = 1$  again. □

*Remark 4.12.* As one can see, in the proof of the above theorem we didn't need the symmetric property  $\psi^2 = id$  for  $\mathcal{C}$ .

The following braided version of Theorem (4.2) in [14], can be proved along the same lines.

**Theorem 4.13.** *If  $H$  is commutative, then*

$$HC_{(\varepsilon, 1)}^n(H) = \bigoplus_{i=n \pmod{2}} HH^i(H, I), \forall n \geq 0, \quad (31)$$

where the left hand side is the cyclic cohomology of the braided Hopf algebra  $H$  with MPI  $(\varepsilon, 1)$  and the right hand side is the Hochschild cohomology of coalgebra  $H$  with coefficients in  $H$ -bimodule  $I$ .

## 5. Hopf cyclic cohomology for super Hopf algebras

In this section we give explicit formulas for the Hopf cyclic complex in the special case of super Hopf algebras and compute it in the super commutative case. The degree of an element  $a$  in a super vector space will be denoted by  $|a|$ .

**Definition 5.1.** A Hopf algebra  $H$  in  $\mathbb{Z}_2$ -Mod is called a super Hopf algebra. Thus a super Hopf algebra  $H = H_0 \oplus H_1$  is simultaneously a super algebra and a super coalgebra and the two structures are compatible in the sense that for all homogeneous elements  $a, b \in H$ :

$$\Delta(ab) = (-1)^{|a_{(2)}||b_{(1)}|} (a_{(1)}b_{(1)} \otimes a_{(2)}b_{(2)}). \quad (32)$$

Furthermore, there is an even map  $S: H \rightarrow H$ , the antipode, such that:  $S(h^{(1)})h^{(2)} = h^{(1)}S(h^{(2)}) = \varepsilon(h)1$ , for all  $h$  in  $H$ .

One easily checks that formulas (10) and (12) in Proposition 2.10 reduce to:

$$\begin{aligned} S(ab) &= (-1)^{|a||b|} S(b)S(a), \\ \Delta S(a) &= S(a)_{(1)} \otimes S(a)_{(2)} = (-1)^{|a_{(1)}||a_{(2)}|} S(a_{(2)}) \otimes S(a_{(1)}). \end{aligned}$$

*Remark 5.2.* We emphasize that condition (32) shows that a super Hopf algebra is, in general, not a Hopf algebra in the category of vector spaces. It is of course a Hopf algebra object in the category of super Hopf algebras (Example 2.3)

Let  $H = H_0 \oplus H_1$  be a super Hopf algebra and  $(\delta, \sigma)$  be a super MPI for  $H$ . One checks that formulas (25), (26), and (27) in Proposition 4.3 reduce to:

$$\begin{aligned}\tilde{S}(ab) &= (-1)^{|a||b|} \tilde{S}(b)\tilde{S}(a), \\ \Delta\tilde{S}(a) &= \tilde{S}(a)_{(1)} \otimes \tilde{S}(a)_{(2)} = (-1)^{|a_{(1)}||a_{(2)}|} S(a_{(2)}) \otimes \tilde{S}(a_{(1)}), \\ S(\sigma) &= \tilde{S}(\sigma) = \sigma^{-1}.\end{aligned}$$

**Proposition 5.3.** *Let  $H = H_0 \oplus H_1$  be a super Hopf algebra endowed with a braided modular pair in involution  $(\delta, \sigma)$ . Then the complex, faces, degeneracies and cyclic maps of Theorem 4.7 can be written as:*

$$\begin{aligned}C^0(H) &= \mathbb{C} \quad \text{and} \quad C^n(H) = H^n, n \geq 1, \\ \delta_i(h_1, \dots, h_{n-1}) &= \begin{cases} (1, h_1, h_2, \dots, h_{n-1}) & i = 0 \\ (h_1, h_2, \dots, h_i^{(1)}, h_i^{(2)}, \dots, h_{n-1}) & 1 \leq i \leq n-1 \\ (h_1, h_2, \dots, h_{n-1}, \sigma) & i = n \end{cases} \\ \sigma_i(h_1, h_2, \dots, h_{n+1}) &= \varepsilon(h_{i+1}) (h_1, h_2, \dots, h_i, h_{i+2}, \dots, h_{n+1}), 0 \leq i \leq n, \\ \tau_n(h_1, h_2, \dots, h_n) &= \alpha\beta (S(h_1^{(n)})h_2, S(h_1^{(n-1)})h_3, \dots, S(h_1^{(2)})h_n, \tilde{S}(h_1^{(1)})\sigma),\end{aligned}$$

where  $h_i$ 's are homogeneous elements and:

$$\begin{aligned}\alpha &= \prod_{i=1}^{n-1} (-1)^{(|h_1^{(1)}| + \dots + |h_1^{(i)}|)(|h_1^{(i+1)}|)}, \\ \beta &= \prod_{j=1}^{n-1} (-1)^{|h_1^{(j)}|(|h_2| + |h_3| + \dots + |h_{n-j+1}|)}.\end{aligned}$$

The next lemma is a corollary of Lemma 4.11.

**Lemma 5.4.** *If a super Hopf algebra  $H = H_0 \oplus H_1$  is super commutative or super-cocommutative, then  $S^2 = 1$  and thus  $(\varepsilon, 1)$  is a super MPI for  $H$ .*

The next proposition is a corollary of Theorem 4.13

**Proposition 5.5.** *If a super Hopf algebra  $H = H_0 \oplus H_1$  is super commutative, then we have a decomposition:*

$$HC_{(\varepsilon, 1)}^n(H) = \bigoplus_{i=n \pmod{2}} HH^i(H, \mathbb{C}), \forall n \geq 0.$$

*Remark 5.6.* All the results of this section easily extend to the case of differential graded super Hopf algebras.

## 6. Hopf cyclic cohomology of the enveloping algebra of a super Lie algebra

A good reference for super Lie algebras, their enveloping algebras, and a super analogue of the Poincaré-Birkhoff-Witt theorem is [9]. This latter result is specially important for the proof of Lemma 6.2. Let  $\mathfrak{g} = \mathfrak{g}_0 \oplus \mathfrak{g}_1$  be a super Lie algebra, let

$$\bigwedge \mathfrak{g} := \frac{T(\mathfrak{g})}{(a \otimes b + (-1)^{|a||b|} b \otimes a)},$$

be the exterior algebra of  $\mathfrak{g}$  and let

$$H = U(\mathfrak{g}) := \frac{T(\mathfrak{g})}{([a, b] - a \otimes b + (-1)^{|a||b|} b \otimes a)},$$

be the enveloping algebra of  $\mathfrak{g}$ . Here  $T(\mathfrak{g})$  is the tensor algebra of  $\mathfrak{g}$ . All these constructions are done in the category of super vector spaces [9].  $U(\mathfrak{g})$  is a super cocommutative super Hopf algebra. Our goal in this section is to show that, analogous to the non-graded case [6, 7, 8], the relation

$$HP_{(\delta,1)}^*(U(\mathfrak{g})) = \bigoplus_{i=*(\text{mod } 2)} H_i(\mathfrak{g}; \mathbb{C}_\delta),$$

holds, where  $\delta$  is a character for  $\mathfrak{g}$ . Here  $HP_{(\delta,1)}^*(U(\mathfrak{g}))$  is the periodic Hopf cyclic cohomology of the super Hopf algebra  $H = U(\mathfrak{g})$ , and  $H_i(\mathfrak{g}; \mathbb{C}_\delta)$  is the Lie algebra homology of  $\mathfrak{g}$  with coefficient in the  $\mathfrak{g}$ -module  $\mathbb{C}_\delta$ .

First, we notice that the Hochschild cohomology  $HH^*(H, \mathbb{C}_\sigma)$  depends only on the coalgebra structure of  $H$  and the grouplike elements  $\sigma$  and 1. In fact we have:

**Lemma 6.1.**  $HH^*(H, \mathbb{C}_\sigma) = \text{Cotor}_H^*(\mathbb{C}, \mathbb{C}_\sigma)$ .

Let

$$S(\mathfrak{g}) := \frac{T(\mathfrak{g})}{(a \otimes b - (-1)^{|a||b|} b \otimes a)},$$

denote the symmetric algebra of the super vector space  $\mathfrak{g}$ . It is a super cocommutative super Hopf algebra with the comultiplication defined by  $\Delta(x) = x \otimes 1 + 1 \otimes x$  for homogeneous elements  $x$  of  $\mathfrak{g}$ . Since by the super Poincaré-Birkhoff-Witt theorem [9],  $U(\mathfrak{g}) = S(\mathfrak{g})$  as super coalgebras one, using Lemma 6.1, can prove the following lemma analogous to the non super case [16].

**Lemma 6.2.** *The antisymmetrization map*

$$A : \bigwedge^n \mathfrak{g} \longrightarrow U(\mathfrak{g})^n,$$

defined by

$$A(x_1 \wedge \cdots \wedge x_n) = \left( \sum_{\sigma \in S_n} (-1)^{\alpha_\sigma} \text{sign}(\sigma)(x_{\sigma(1)}, \dots, x_{\sigma(n)}) \right) / n!,$$

induces an isomorphism  $HH^*(U(\mathfrak{g}), \mathbb{C}) = \bigwedge^*(\mathfrak{g})$ . Here

$$\alpha_\sigma = \sum_{i=1}^n |x_{\sigma(i)}| (|x_1| + |x_2| + \cdots + \widehat{|x_{\sigma(j)}|} + \cdots + |x_{\sigma(i)-1}|),$$

where  $\widehat{|x_{\sigma(j)}|}$  means that if there are any of  $|x_{\sigma(j)}|$ 's for all  $j < i$  they should be omitted. Simply  $\alpha_\sigma$  contains  $|a||b|$  for any two elements  $a$  and  $b$  of  $x_i$ 's, if they cross each other.

The following complex is the super analogue of the Chevalley-Eilenberg complex to compute the Lie algebra homology  $H_\bullet(\mathfrak{g}, \mathbb{C}_\delta)$  of the super Lie algebra  $\mathfrak{g}$ :

$$\bigwedge^0 \mathfrak{g} \xleftarrow{\delta} \bigwedge^1 \mathfrak{g} \xleftarrow{d} \bigwedge^2 \mathfrak{g} \xleftarrow{d} \bigwedge^3 \mathfrak{g} \xleftarrow{d} \dots$$

$$\begin{aligned} d(x_1, \dots, x_n) &= \left( \sum_{i=1}^n (-1)^{i+1+\alpha_i} \delta(x_i) x_1 \wedge \dots \wedge \hat{x}_i \wedge \dots \wedge x_n \right) \\ &+ \left( \sum_{i < j} (-1)^{i+j+\alpha_i+\alpha_j-|x_i||x_j|} [x_i, x_j] \wedge x_1 \wedge \dots \wedge \hat{x}_i \wedge \dots \wedge \hat{x}_j \wedge \dots \wedge x_n \right), \end{aligned}$$

where  $\alpha_1 := 0$  and  $\alpha_i = |x_i|(|x_1| + \dots + |x_{i-1}|)$ ;  $i > 1$ .

Clearly we have a double complex

$$\bigwedge^0 \mathfrak{g} \xrightleftharpoons[0]{d} \bigwedge^1 \mathfrak{g} \xrightleftharpoons[0]{d} \bigwedge^2 \mathfrak{g} \xrightleftharpoons[0]{d} \dots$$

whose total homology is  $\bigoplus_{i \equiv * \pmod{2}} H_i(\mathfrak{g}; \mathbb{C}_\delta)$ . On the other hand we have the  $(b, B)$  double complex

$$U(\mathfrak{g})^0 \xrightleftharpoons[b]{B} U(\mathfrak{g})^1 \xrightleftharpoons[b]{B} U(\mathfrak{g})^2 \xrightleftharpoons[b]{B} \dots$$

whose total homology is  $HP_{(\delta,1)}^*(U(\mathfrak{g}))$ .

One checks that the antisymmetrization map  $A$  commutes with the  $B$ -operator, i.e.,  $BA = Ad$ . Now using Lemma 6.2 we conclude that the antisymmetrization map

$$A : \bigwedge^n \mathfrak{g} \longrightarrow U(\mathfrak{g})^n,$$

defines a quasi-isomorphism between the above double complexes. Summarizing everything we have:

**Theorem 6.3.**

$$HP_{(\delta,1)}^*(U(\mathfrak{g})) = \bigoplus_{i \equiv * \pmod{2}} H_i(\mathfrak{g}; \mathbb{C}_\delta).$$

## 7. Hopf cyclic cohomology in non-symmetric monoidal categories

In Theorem 4.7 we obtained a braided version of Connes-Moscovici's Hopf cyclic theory in a symmetric monoidal category. This was obtained as a special case of a more general result in Section 3, for braided triples  $(H, C, M)$  in a symmetric monoidal category. In this section we proceed to eliminate the restrictive symmetry condition  $\psi^2 = id$ . For this, we will directly show that the complex of Theorem 4.7 remains paracyclic in *any* braided abelian monoidal category  $\mathcal{C}$ , without any symmetry condition on the part of  $\mathcal{C}$  (Theorem 7.1 below). We shall also indicate how the symmetry

condition on the braiding is related to the cyclic condition  $\tau_n^{n+1} = id$  (Theorem 7.3 below). The upshot is that to obtain a cocyclic object and a Hopf cyclic cohomology in non-symmetric monoidal categories one must inevitably restrict to the subcomplex  $\ker(1 - \tau_n^{n+1})$  (cf. formula (13)). This procedure can, to some extent, be generalized to braided triples as in Theorem 3.6. This more general case however needs some additional structure and will be dealt with elsewhere.

**Theorem 7.1.** *Let  $(H, (\delta, \sigma))$  be a braided Hopf algebra in a braided abelian monoidal category  $\mathcal{C}$ , where  $(\delta, \sigma)$  is a BMPI. The following defines a para-cocyclic object in  $\mathcal{C}$ :*

$$\begin{aligned} C^0(H) &= I \quad \text{and} \quad C^n(H) = H^n, \quad n \geq 1, \\ \delta_i &= \begin{cases} (\eta, 1, 1, \dots, 1) & i = 0 \\ (1, 1, \dots, 1, \underset{i\text{-th}}{\Delta}, 1, 1, \dots, 1) & 1 \leq i \leq n-1 \\ (1, 1, \dots, 1, \sigma) & i = n \end{cases} \\ \sigma_i &= (1, 1, \dots, \underset{(i+1)\text{-th}}{\varepsilon}, 1, 1, \dots, 1), \quad 0 \leq i \leq n \\ \tau_n &= \begin{cases} id_I & n = 0 \\ (m_n)(\Delta^{n-1} \tilde{S}, 1_{H^{n-1}}, \sigma) & n \neq 0. \end{cases} \end{aligned}$$

Here by  $m_n$  we mean,  $m_1 = m$ , and for  $n \geq 2$ :

$$m_n = m_{H^n} = \underbrace{(m, m, \dots, m)}_{n \text{ times}} \mathcal{F}_n(\psi),$$

where

$$\mathcal{F}_n(\psi) := \prod_{j=1}^{n-1} (1_{H^j}, \underbrace{\psi, \psi, \dots, \psi}_{n-j \text{ times}}, 1_{H^j}).$$

Since the proof includes a very long series of long formulas, we try to visualize some essential steps by braiding diagrams. Of course it takes a very large amount of space to show all the steps by diagrams.

*Proof.* Among all relations in a para-cocyclic object, only the relations

$$\tau_n \sigma_0 = \sigma_n \tau_{n+1}^2, \quad \tau_n \sigma_i = \sigma_{i-1} \tau_{n+1},$$

and others involving the cyclic operator  $\tau_n$  are not obvious because the braiding map is involved. Here we give a detailed proof of the first formula in degree  $n = 2$ , i.e., we prove that  $\tau_2 \sigma_0 = \sigma_2 \tau_3^2$ . In the following, in addition to our previous conventions, we shall write  $(3, \psi, 2)$  for  $(1, 1, 1, \psi, 1, 1)$ ,  $\psi_{23}$  for  $\psi_{H^2 \otimes H^3}$ , and so on. We have:

$$\begin{aligned} \sigma_2 \tau_3^2 &\stackrel{(30)}{=} (1, 1, \varepsilon)(m_3)(\Delta^2 \tilde{S}, 1, 1, \sigma)(m_3)(\Delta^2 \tilde{S}, 1, 1, \sigma) \\ &= (1, 1, \varepsilon)(m, m, m)(1, \psi, 3)(3, \psi, 1)(2, \psi, 2) \\ &\quad ((S, S, \tilde{S})(1, \psi)(\psi, 1)(1, \psi) \Delta^2, 1, 1, \sigma)(m, m, m)(1, \psi, 3)(3, \psi, 1)(2, \psi, 2) \\ &\quad ((S, S, \tilde{S})(1, \psi)(\psi, 1)(1, \psi) \Delta^2, 1, 1, \sigma) \end{aligned}$$

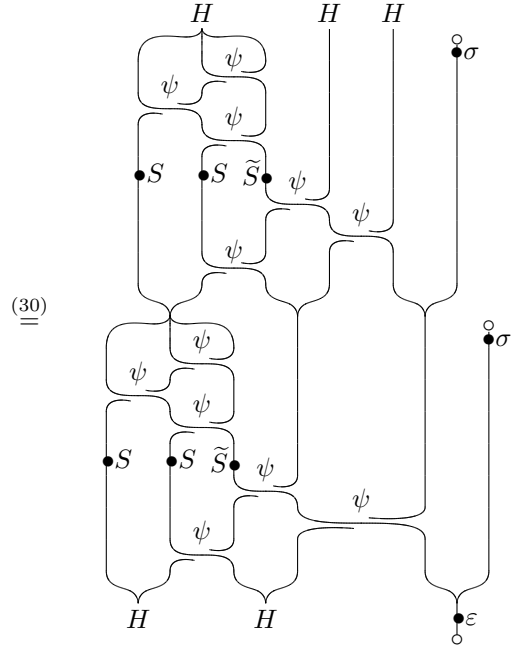

$$\stackrel{(1)}{=} (m, m, \varepsilon m)(1, \psi, 3)(3, \psi, 1)(2, \psi, 2)(S, S, \tilde{S}, 1, 1, \sigma)(1, \psi, 2)(\psi, 3)(1, \psi, 2) \\ (\Delta^2 m, m, m)(S, 1, S, 1, \tilde{S}, \sigma)(1, \psi, 2)(3, \psi)(2, \psi, 1)(1, \psi, 2)(\psi, 3)(1, \psi, 2)(\Delta^2, 2)$$

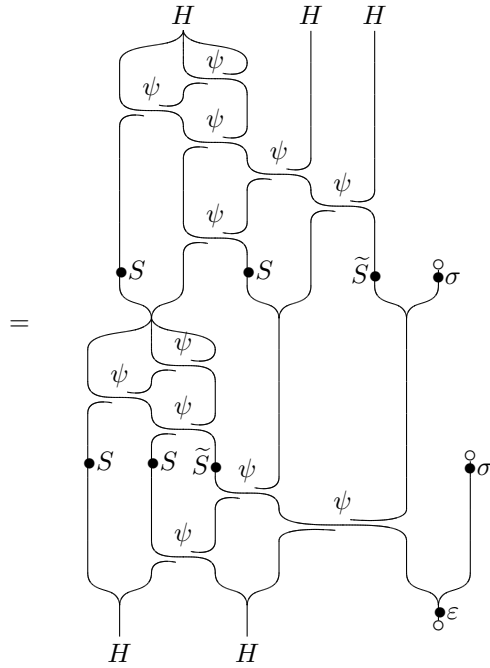

$$\begin{aligned}
& \stackrel{(1), (9)}{=} (m, m, \varepsilon, \varepsilon)(S, 1, S, 1, \tilde{S}, \sigma)(1, \psi, 2)(3, \psi)(2, \psi, 1)(1, \psi, 2)(\psi, 3)(1, \psi, 2) \\
& \quad ((m, m, m)(1, \psi, 3)(3, \psi, 1)(2, \psi, 2)(\Delta^2, \Delta^2), m, m)(S, 1, S, 1, \tilde{S}, \sigma) \\
& \quad (1, \psi, 2)(3, \psi)(2, \psi, 1)(1, \psi, 2)(\psi, 3)(1, \psi, 2)(\Delta^2, 2)
\end{aligned}$$

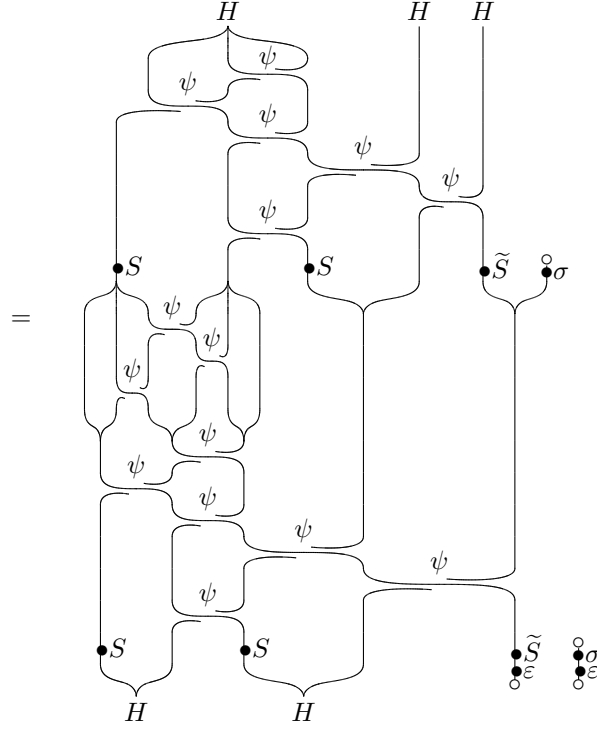

$$\begin{aligned}
& = (m, m)(S, 1, S, 1, \varepsilon\tilde{S}, \varepsilon\sigma)(1, \psi, 2)(3, \psi)(2, \psi, 1)(1, \psi, 2)(\psi, 3)(1, \psi, 2) \\
& \quad (m, m, m, m, m)(1, \psi, 7)(3, \psi, 5)(2, \psi, 6)(\Delta^2, \Delta^2, 4)(S, 1, S, 1, \tilde{S}, \sigma) \\
& \quad (1, \psi, 2)(3, \psi)(2, \psi, 1)(1, \psi, 2)(\psi, 3)(1, \psi, 2)(\Delta^2, 2) \\
& = (m, m)(S, 1, S, 1, \delta)(1, \psi, 2)(3, \psi)(2, \psi, 1)(1, \psi, 2)(\psi, 3)(1, \psi, 2) \\
& \quad (m, m, m, m, m)(1, \psi, 7)(3, \psi, 5)(2, \psi, 6)(\Delta^2 S, \Delta^2, S, 1, \tilde{S}, \sigma) \\
& \quad (1, \psi, 2)(3, \psi)(2, \psi, 1)(1, \psi, 2)(\psi, 3)(1, \psi, 2)(\Delta^2, 2) \\
& = (m, m)(S, 1, S, 1, \delta)(m, m, m, m, m)(2, \psi_{2,2}, 4)(6, \psi_{2,2})(4, \psi_{2,2}, 2)(2, \psi_{2,2}, 4) \\
& \quad (\psi_{2,2}, 6)(2, \psi_{2,2}, 4)(1, \psi, 7)(3, \psi, 5)(2, \psi, 6)(S, S, S, 3, S, 1, \tilde{S}, \sigma)(1, \psi, 6) \\
& \quad (\psi, 7)(1, \psi, 6)(\Delta^2, \Delta^2, 3)(1, \psi, 2)(3, \psi)(2, \psi, 1)(1, \psi, 2)(\psi, 3)(1, \psi, 2)(\Delta^2, 2) \\
& = (m, m)(Sm, m, Sm, m, \delta m)(2, \psi_{2,2}, 4)(6, \psi_{2,2})(4, \psi_{2,2}, 2)(2, \psi_{2,2}, 4) \\
& \quad (\psi_{2,2}, 6)(2, \psi_{2,2}, 4)(S, 1, S, 1, S, 1, S, 1, \tilde{S}, \sigma)(1, \psi, 6)(3, \psi, 4)(2, \psi, 5)(1, \psi, 6) \\
& \quad (\psi, 7)(1, \psi, 6)(\Delta^2, \Delta^2, 3)(1, \psi, 2)(3, \psi)(2, \psi, 1)(1, \psi, 2)(\psi, 3)(1, \psi, 2)(\Delta^2, 2)
\end{aligned}$$



$$\begin{aligned}
 &= (m, m)(m\psi, m, m\psi, m)(S, S, 1, 1, S, S, 1, 1, \delta, \delta)(2, \psi_{2,2}, 4)(6, \psi_{2,2}) \\
 &\quad (4, \psi_{2,2}, 2)(2, \psi_{2,2}, 4)(\psi_{2,2}, 6)(2, \psi_{2,2}, 4)(S, 1, S, 1, S, 1, S, 1, \tilde{S}, \sigma) \\
 &\quad (1, \psi, 6)(3, \psi, 4)(2, \psi, 5)(1, \psi, 6)(\psi, 7)(1, \psi, 6)(\Delta^2, \Delta^2, 3) \\
 &\quad (1, \psi, 2)(3, \psi)(2, \psi, 1)(1, \psi, 2)(\psi, 3)(1, \psi, 2)(\Delta^2, 2) \\
 &= (m, m)(m\psi, m, m\psi, m)(2, \psi_{2,2}, 2)(\psi_{2,2}, 4)(\delta, \delta, S, S, S, S, 4) \\
 &\quad (S, 1, S, 1, S, 1, S, 1, \tilde{S}, \sigma)(1, \psi, 6)(3, \psi, 4)(2, \psi, 5)(1, \psi, 6)(\psi, 7)(1, \psi, 6) \\
 &\quad (\Delta^2, \Delta^2, 3)(1, \psi, 2)(3, \psi)(2, \psi, 1)(1, \psi, 2)(\psi, 3)(1, \psi, 2)(\Delta^2, 2) \\
 &= (m, m)(1, \psi, 1)(\psi, 2)(m\psi, m\psi, m, m)(\delta S, \delta, S^2, S, S^2, S, S, 1, \tilde{S}, \sigma) \\
 &\quad (1, \psi, 6)(3, \psi, 4)(2, \psi, 5)(1, \psi, 6)(\psi, 7)(1, \psi, 6)(\Delta^2, \Delta^2, 3)(1, \psi, 2)(3, \psi) \\
 &\quad (2, \psi, 1)(1, \psi, 2)(\psi, 3)(1, \psi, 2)(\Delta^2, 2) \\
 &= (m, m)(1, \psi, 1)(\psi, 2)(m\psi, m\psi, m, m)(1, \psi, 5)(\psi, 6) \\
 &\quad (S^2, S^2, \delta S, \delta, S, S, S, 1, \tilde{S}, \sigma)(\Delta^2, \Delta^2, 3)(1, \psi, 2)(3, \psi)(2, \psi, 1)(1, \psi, 2)(\psi, 3) \\
 &\quad (1, \psi, 2)(\Delta^2, 2) \\
 &= (m, m)(1, \psi, 1)(\psi, 2)(m\psi, m\psi, m, m)(1, \psi, 5)(\psi, 6) \\
 &\quad (S^2, S^2, \delta S, \delta, S, S, S, 1, \tilde{S}, \sigma)(3, \Delta^2, 3)(3, \psi, 2)(5, \psi)(4, \psi, 1)(3, \psi, 2)(\Delta^2, 4) \\
 &\quad (\psi, 3)(1, \psi, 2)(\Delta^2, 2)
 \end{aligned}$$

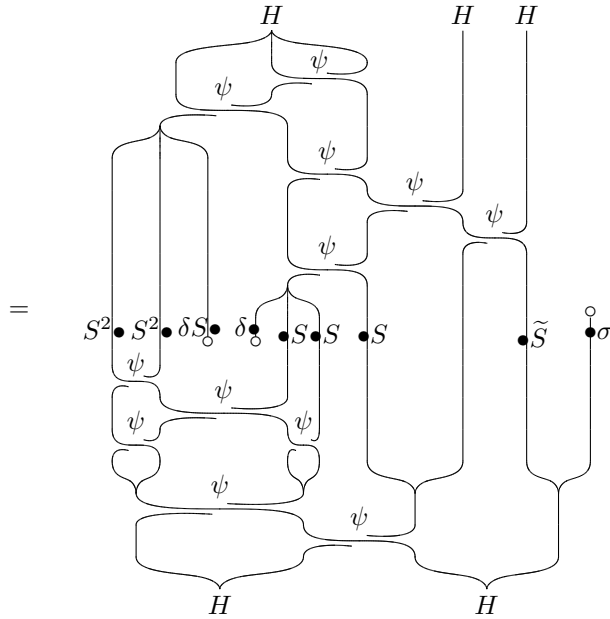

$$\begin{aligned}
 &= (m, m)(1, \psi, 1)(\psi, 2)(m\psi, m\psi, m, m)(1, \psi, 5)(\psi, 6) \\
 &\quad (S^2, S^2, \delta S, \delta, S, S, S, 1, \tilde{S}, \sigma)(3, \Delta^2, 3)(3, \psi, 2)(5, \psi)(4, \psi, 1)(3, \psi, 2)(\psi_{13}, 3) \\
 &\quad (1, \psi_{13}, 2)(2, \Delta^2, 2)(\Delta^2, 2)
 \end{aligned}$$

$$\begin{aligned}
 &= (m, m)(1, \psi, 1)(\psi, 2)(m\psi, m\psi, m, m)(1, \psi, 5)(\psi, 6) \\
 &\quad (S^2, S^2, \delta S, \delta, S, S, S, 1, \tilde{S}, \sigma)(3, \psi_{13}, 2)(7, \psi)(4, \psi_{13}, 1)(3, \psi, 4) \\
 &\quad (\psi_{13}, 3)(1, \psi_{13}, 2)(5, \Delta^2, 1)(2, \Delta^2, 2)(\Delta^2, 2) \\
 &= (m, m)(1, \psi, 1)(\psi, 2)(m\psi, m\psi, m, m)(1, \psi, 5)(\psi, 6)(2, \psi_{12}, 3)(5, \psi, 3) \\
 &\quad (3, \psi_{12}, 2)(2, \psi, 4)(\psi_{12}, 5)(1, \psi_{12}, 4)(\tilde{S}, S, S^2, S^2, \delta S, \delta, S, S, 1, \sigma)(5, \Delta^2, 1) \\
 &\quad (2, \Delta^2, 2)(\Delta^2, 2) \\
 &= (m, m)(1, \psi, 1)(\psi, 2)(m\psi, m\psi, m, m)(1, \psi, 5)(\psi, 6) \\
 &\quad (S^2, S^2, \delta, S, S, S, 1, \tilde{S}, \delta S, \sigma)(2, \psi_{13}, 3)(6, \psi_{21})(3, \psi_{23}, 1)(2, \psi, 5)(\psi_{12}, 6) \\
 &\quad (1, \psi_{12}, 5)(5, \Delta^2, 1)(2, \Delta^2, 2)(\Delta^2, 2) \\
 &= (m, m)(1, \psi, 1)(\psi, 2)(m\psi, m\psi, m, m)(1, \psi, 5)(\psi, 6) \\
 &\quad (S^2, S^2, \delta, S, S, S, 1, \tilde{S}, \sigma, \delta S)(4, \psi, 3)(3, \psi, 4)(2, \psi, 5)(6, \psi, 1)(7, \psi)(5, \psi, 2) \\
 &\quad (6, \psi, 1)(4, \psi, 3)(5, \psi, 2)(3, \psi, 4)(4, \psi, 3)(2, \psi, 5)(1, \psi, 6)(\psi, 7)(2, \psi, 5)(1, \psi, 6) \\
 &\quad (5, \Delta^2, 1)(2, \Delta^2, 2)(\Delta^2, 2)
 \end{aligned}$$

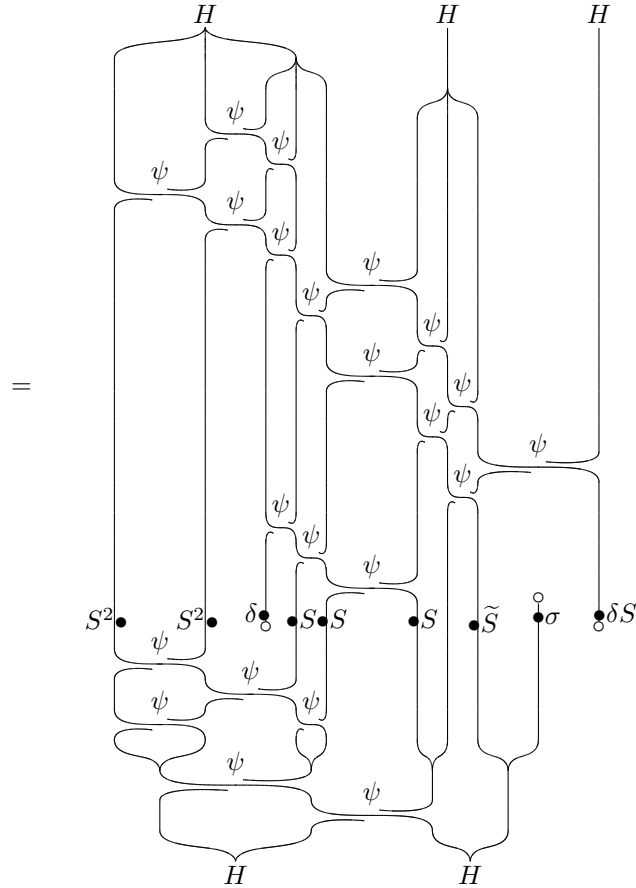

$$\begin{aligned}
 &= (m, m)(1, \psi, 1)(\psi, 2)(m\psi, m\psi, m, m)(1, \psi, 5)(\psi, 6) \\
 &\quad (S^2, S^2, \delta, S, S, S, 1, \tilde{S}, \delta S, \sigma)(4, \psi, 3)(3, \psi, 4)(2, \psi, 5)(6, \psi, 1)(5, \psi, 2) \\
 &\quad (4, \psi, 3)(3, \psi, 4)(7, \psi)(6, \psi, 1)(5, \psi, 2)(4, \psi, 3)(2, \psi, 5)(1, \psi, 6)(\psi, 7) \\
 &\quad (2, \psi, 5)(1, \psi, 6)(5, \Delta^2, 1)(2, \Delta^2, 2)(\Delta^2, 2) \\
 &= (m, m)(1, \psi, 1)(\psi, 2)(m\psi, m\psi, m, m)(1, \psi, 5)(\psi, 6) \\
 &\quad (S^2, S^2, \delta, S, S, S, 1, \tilde{S}, \delta S, \sigma)(4, \psi, 3)(3, \psi, 4)(2, \psi, 5)(6, \psi, 1) \\
 &\quad (5, \psi, 2)(4, \psi, 3)(3, \psi, 4)(2, \psi, 5)(1, \psi, 6)(\psi, 7)(2, \psi, 5)(1, \psi, 6) \\
 &\quad (7, \psi)(6, \psi, 1)(5, \psi, 2)(4, \psi, 3)(5, \Delta^2, 1)(2, \Delta^2, 2)(\Delta^2, 2) \\
 &= (m, m)(1, \psi, 1)(\psi, 2)(m, m, m, m)(\psi, 6)(2, \psi, 4)(1, \psi, 5)(\psi, 6)(3, \psi, 3)(2, \psi, 4) \\
 &\quad (5, \psi, 1)(4, \psi, 2)(3, \psi, 3)(2, \psi, 4)(1, \psi, 5)(S^2, \tilde{S}, S^2, S, \delta, S, S, 1, \sigma, \delta S)(\psi, 7) \\
 &\quad (2, \psi, 5)(1, \psi, 6)(7, \psi)(6, \psi, 1)(5, \psi, 2)(4, \psi, 3)(5, \Delta^2, 1)(2, \Delta^2, 2)(\Delta^2, 2) \\
 &= (m, m)(1, \psi, 1)(\psi, 2)(m, m, m, m)(\psi, 6)(2, \psi, 4)(1, \psi, 5)(3, \psi, 3)(2, \psi, 4) \\
 &\quad (5, \psi, 1)(4, \psi, 2)(3, \psi, 3)(2, \psi, 4)(\psi, 6)(1, \psi, 5) \\
 &\quad (S^2, (\delta, S)\Delta, S^2, S, \delta, S, S, 1, \sigma, \delta S)(\psi, 7)(2, \psi, 5)(1, \psi, 6)(7, \psi)(6, \psi, 1) \\
 &\quad (5, \psi, 2)(4, \psi, 3)(5, \Delta^2, 1)(2, \Delta^2, 2)(\Delta^2, 2) \\
 &= (m, m)(1, \psi, 1)(\psi, 2)(m, m, m, m)(\psi, 6)(2, \psi, 4)(1, \psi, 5)(3, \psi, 3)(2, \psi, 4) \\
 &\quad (5, \psi, 1)(4, \psi, 2)(3, \psi, 3)(2, \psi, 4)(\psi, 6)(1, \psi, 5) \\
 &\quad (S^2, \delta, S, S^2, S, \delta, S, S, 1, \sigma, \delta S)(1, \Delta, 7)(\psi, 7)(2, \psi, 5)(1, \psi, 6)(7, \psi)(6, \psi, 1) \\
 &\quad (5, \psi, 2)(4, \psi, 3)(5, \Delta^2, 1)(2, \Delta^2, 2)(\Delta^2, 2) \\
 &= (1, m)(m, 2)(\psi_{12}, 1)(m, m, m, m)(\psi, 6)(2, \psi, 4)(1, \psi, 5)(3, \psi, 3)(2, \psi, 4) \\
 &\quad (5, \psi, 1)(4, \psi, 2)(3, \psi, 3)(2, \psi, 4)(\psi, 6)(1, \psi, 5)(S^2, \delta, S, S^2, S, \delta, S, S, 1, \sigma, \delta S) \\
 &\quad (\psi_{21}, 7)(3, \psi, 5)(2, \psi, 6)(8, \psi)(7, \psi, 1)(6, \psi, 2)(5, \psi, 3)(\Delta, 8)(5, \Delta, 2) \\
 &\quad (5, \Delta, 1)(2, \Delta, 3)(2, \Delta, 2)(\Delta, 3)(\Delta, 2) \\
 &= (1, m)(\psi, 1)(1, m, 1)(m, 2, m)(2, m, 3)(4, m, 2)(\psi, 6)(2, \psi, 4)(1, \psi, 5)(3, \psi, 3) \\
 &\quad (2, \psi, 4)(5, \psi, 1)(4, \psi, 2)(3, \psi, 3)(2, \psi, 4)(\psi, 6)(1, \psi, 5) \\
 &\quad (S^2, \delta, S, S^2, S, \delta, S, S, 1, \sigma, \delta S)(\psi_{21}, 7)(3, \psi, 5)(2, \psi, 6)(8, \psi)(7, \psi, 1) \\
 &\quad (5, \psi_{12}, 2)(6, \Delta, 2)(\Delta, 7)(5, \Delta, 1)(2, \Delta, 3)(2, \Delta, 2)(\Delta, 3)(\Delta, 2) \\
 &= (1, m)(\psi, 1)(m, 1, m)(2, m, 2)(2, m, 3)(4, m, 2)(\psi, 6)(2, \psi, 4)(1, \psi, 5)(3, \psi, 3) \\
 &\quad (2, \psi, 4)(5, \psi, 1)(4, \psi, 2)(3, \psi, 3)(2, \psi, 4)(\psi, 6)(1, \psi, 5) \\
 &\quad (S^2, \delta, S, S^2, S, \delta, S, S, 1, \sigma, \delta S)(\psi_{21}, 7)(3, \psi, 5)(2, \psi, 6)(8, \psi)(7, \psi, 1)(5, \psi_{12}, 2) \\
 &\quad (6, \Delta, 2)(\Delta, 7)(5, \Delta, 1)(2, \Delta, 3)(2, \Delta, 2)(\Delta, 3)(\Delta, 2)
 \end{aligned}$$

$$\begin{aligned}
 &= (1, m)(\psi, 1)(m, 1, m)(2, m, 2)(3, m, 2)(4, m, 2)(\psi, 6)(2, \psi, 4)(1, \psi, 5)(3, \psi, 3) \\
 &\quad (2, \psi, 4)(5, \psi, 1)(4, \psi, 2)(3, \psi, 3)(2, \psi, 4)(\psi, 6)(1, \psi, 5) \\
 &\quad (S^2, \delta, S, S^2, S, \delta, S, S, 1, \sigma, \delta S)(\psi, 8)(5, \Delta, 3)(1, \psi, 6)(3, \psi, 4)(2, \psi, 5) \\
 &\quad (7, \psi)(6, \psi, 1)(5, \psi, 2)(\Delta, 7)(5, \Delta, 1)(2, \Delta, 3)(2, \Delta, 2)(\Delta, 3)(\Delta, 2) \\
 \\
 &= (1, m)(\psi, 1)(m, 1, m)(2, m, 2)(3, m, 2)(3, m, 3)(\psi, 6)(2, \psi, 4)(1, \psi, 5)(3, \psi, 3) \\
 &\quad (2, \psi, 4)(5, \psi, 1)(4, \psi, 2)(3, \psi, 3)(2, \psi, 4)(\psi, 6)(1, \psi, 5) \\
 &\quad (\delta, S^2, S, S^2, S, (\delta, S)\Delta, S, 1, \sigma, \delta S)(1, \psi, 6)(3, \psi, 4)(2, \psi, 5)(7, \psi) \\
 &\quad (6, \psi, 1)(5, \psi, 2)(\Delta, 7)(5, \Delta, 1)(2, \Delta, 3)(2, \Delta, 2)(\Delta, 3)(\Delta, 2)
 \end{aligned}$$

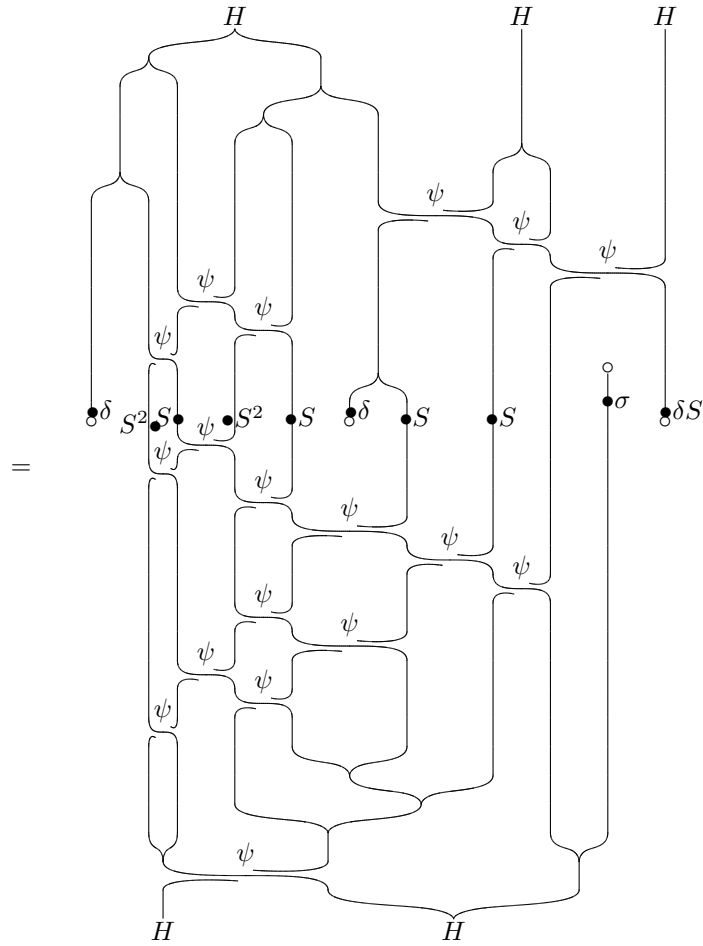

$$\begin{aligned}
 &= (1, m)(\psi, 1)(m, 1, m)(2, m, 2)(3, m, 2)(3, m, 3)(\psi, 6)(2, \psi, 4)(1, \psi, 5)(3, \psi, 3) \\
 &\quad (2, \psi, 4)(5, \psi, 1)(4, \psi, 2)(3, \psi, 3)(2, \psi, 4)(\psi, 6)(1, \psi, 5)(\psi, 6) \\
 &\quad (\delta, S, S^2, S^2, S, \tilde{S}, S, 1, \sigma, \delta S)(3, \psi, 4)(2, \psi, 5)(7, \psi)(6, \psi, 1)(5, \psi, 2) \\
 &\quad (\Delta, 7)(5, \Delta, 1)(2, \Delta, 3)(2, \Delta, 2)(\Delta, 3)(\Delta, 2) \\
 &= (1, m)(\psi, 1)(m, 1, m)(2, m, 2)(3, m, 2)(\psi, 5)(3, m, 3)(2, \psi, ) (3, \psi, 3)(1, \psi, 5) \\
 &\quad (2, \psi, 4)(5, \psi, 1)(4, \psi, 2)(3, \psi, 3)(2, \psi, 4)(1, \psi, 5)(\psi, 6)(1, \psi, 5) \\
 &\quad (\delta, S, S^2, S^2, S, \tilde{S}, S, 1, \sigma, \delta S)(3, \psi, 4)(2, \psi, 5)(7, \psi)(6, \psi, 1)(5, \psi, 2) \\
 &\quad (\Delta, 7)(5, \Delta, 1)(2, \Delta, 3)(2, \Delta, 2)(\Delta, 3)(\Delta, 2) \\
 &= (1, m)(\psi, 1)(m, 1, m)(2, m, 2)(3, m, 2)(\psi, 5)(3, m, 3)(2, \psi_{21}, 3)(1, \psi_{21}, 4) \\
 &\quad (5, \psi, 1)(4, \psi, 2)(3, \psi, 3)(1, \psi_{12}, 4)(\psi, 6)(\delta, S, S^2, S^2, S, \tilde{S}, S, 1, \sigma, \delta S)(2, \psi, 5) \\
 &\quad (3, \psi, 4)(2, \psi, 5)(7, \psi)(6, \psi, 1)(5, \psi, 2)(\Delta, 7)(5, \Delta, 1)(2, \Delta, 3)(2, \Delta, 2)(\Delta, 3)(\Delta, 2) \\
 &= (1, m)(\psi, 1)(m, 1, m)(2, m, 2)(3, m, 2)(\psi, 5)(2, \psi, 3)(1, \psi, 4)(1, m, 5)(5, \psi, 1) \\
 &\quad (4, \psi, 2)(3, \psi, 3)(1, \psi_{12}, 4)(\psi, 6)(\delta, S, S^2, S^2, S, \tilde{S}, S, 1, \sigma, \delta S)(3, \psi, 4)(2, \psi, 5) \\
 &\quad (3, \psi, 4)(7, \psi)(6, \psi, 1)(5, \psi, 2)(\Delta, 7)(5, \Delta, 1)(2, \Delta, 3)(2, \Delta, 2)(\Delta, 3)(\Delta, 2) \\
 &= (1, m)(\psi, 1)(m, 1, m)(2, m, 2)(3, m, 2)(\psi, 5)(2, \psi, 3)(1, \psi, 4)(4, \psi, 1)(3, \psi, 2) \\
 &\quad (2, \psi, 3)(1, m, 5)(1, \psi_{12}, 4)(\psi, 6)(\delta, S, S^2, S^2, S, \tilde{S}, S, 1, \sigma, \delta S)(3, \psi, 4)(2, \psi, 5) \\
 &\quad (3, \psi, 4)(7, \psi)(6, \psi, 1)(5, \psi, 2)(\Delta, 7)(5, \Delta, 1)(2, \Delta, 3)(2, \Delta, 2)(\Delta, 3)(\Delta, 2) \\
 &= (1, m)(\psi, 1)(m, 1, m)(2, m, 2)(3, m, 2)(\psi, 5)(2, \psi, 3)(1, \psi, 4)(4, \psi, 1)(3, \psi, 2) \\
 &\quad (2, \psi, 3)(1, \psi, 4)(2, m, 4)(\psi, 6)(\delta, S, S^2, S^2, S, \tilde{S}, S, 1, \sigma, \delta S)(3, \psi, 4) \\
 &\quad (2, \psi_{21}, 4)(7, \psi)(6, \psi, 1)(5, \psi, 2)(\Delta, 7)(5, \Delta, 1)(2, \Delta, 3)(2, \Delta, 2)(1, \Delta, 2)(\Delta, 2) \\
 &= (1, m)(\psi, 1)(m, 1, m)(2, m, 2)(3, m, 2)(\psi, 5)(2, \psi, 3)(1, \psi, 4)(4, \psi, 1)(3, \psi, 2) \\
 &\quad (2, \psi, 3)(1, \psi, 4)(\psi, 5)(2, m, 4)(\delta, S, S^2, S^2, S, \tilde{S}, S, 1, \sigma, \delta S)(3, \psi, 4) \\
 &\quad (2, \psi_{21}, 4)(7, \psi)(6, \psi, 1)(5, \psi, 2)(\Delta, 7)(5, \Delta, 1)(1, \Delta, 4)(1, \Delta, 3)(1, \Delta, 2)(\Delta, 2) \\
 &= (1, m)(\psi, 1)(m, 1, m)(2, m, 2)(3, m, 2)(\psi, 5)(2, \psi, 3)(1, \psi, 4)(4, \psi, 1)(3, \psi, 2) \\
 &\quad (2, \psi, 3)(1, \psi, 4)(\psi, 5)(2, m, 4)(\delta, S, S^2, S^2, S, \tilde{S}, S, 1, \sigma, \delta S)(3, \psi, 4) \\
 &\quad (2, \psi_{21}, 4)(2, \Delta, 5)(6, \psi)(5, \psi, 1)(4, \psi, 2)(\Delta, 6)(4, \Delta, 1)(1, \Delta, 3)(1, \Delta, 2)(\Delta, 2) \\
 &= (1, m)(\psi, 1)(m, 1, m)(2, m, 2)(3, m, 2)(\psi, 5)(2, \psi, 3)(1, \psi, 4)(4, \psi, 1)(3, \psi, 2) \\
 &\quad (2, \psi, 3)(1, \psi, 4)(\psi, 5)(2, m, 4)(\delta, S, S^2, S^2, S, \tilde{S}, S, 1, \sigma, \delta S)(3, \psi, 4) \\
 &\quad (3, \Delta, 4)(2, \psi, 4)(6, \psi)(5, \psi, 1)(4, \psi, 2)(\Delta, 6)(4, \Delta, 1)(1, \Delta, 3)(1, \Delta, 2)(\Delta, 2) \\
 &= (1, m)(\psi, 1)(m, 1, m)(2, m, 2)(3, m, 2)(\psi, 5)(2, \psi, 3)(1, \psi, 4)(4, \psi, 1)(3, \psi, 2) \\
 &\quad (2, \psi, 3)(1, \psi, 4)(\psi, 5)(\delta, S, S^2, m(S^2, S)\psi\Delta, \tilde{S}, S, 1, \sigma, \delta S)(2, \psi, 4) \\
 &\quad (6, \psi)(5, \psi, 1)(4, \psi, 2)(\Delta, 6)(4, \Delta, 1)(1, \Delta, 3)(1, \Delta, 2)(\Delta, 2)
 \end{aligned}$$

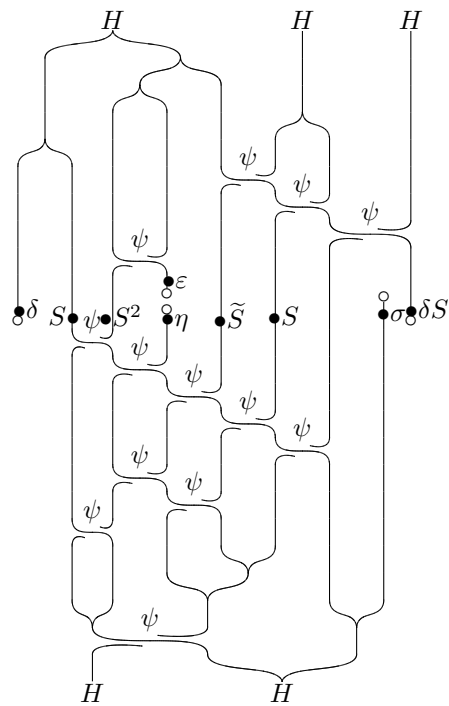
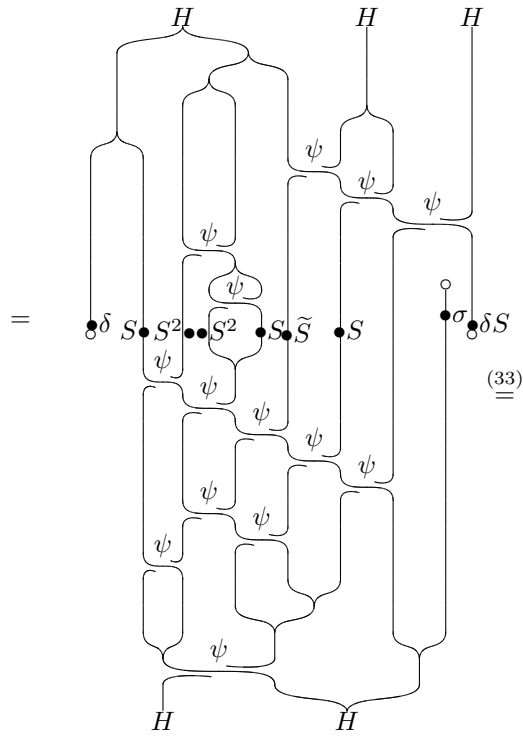

By the same method, using standard identities and properties, including:

$$(1, \psi)(\psi, 1)(1, \psi) = (\psi, 1)(1, \psi)(\psi, 1),$$

one reduces the above digram to the following one:

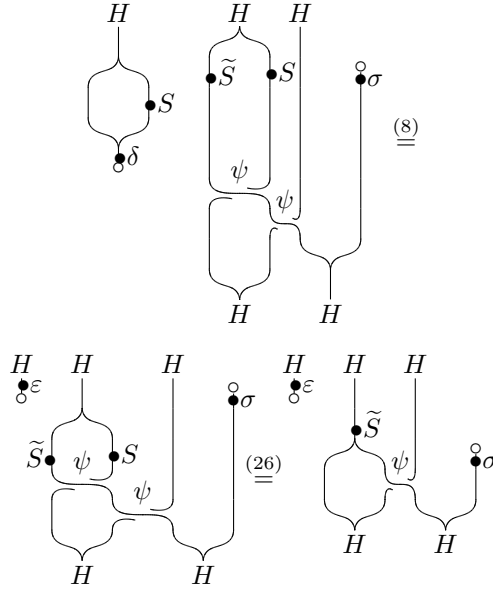

$$= (m, m)(1, \psi, 1)(\Delta\tilde{S}, 1, \sigma)(\varepsilon, 2) = \tau_2\sigma_0. \quad \square$$

**Lemma 7.2.** *It is easy to verify that*

$$m(S^2, \tilde{S})\psi\Delta = \eta\delta$$

$$(33)$$

We use this lemma in the proof of next theorem.

**Theorem 7.3.** *Under the conditions of Theorem 7.1,*

$$\tau_2^3 = \psi_{H,H}^2.$$

*Proof.* We have:

$$\begin{aligned} \tau_2^3 &= \tau_2\tau_2^2 \\ &= \tau_2(m_2)(\Delta\tilde{S}, 1, \sigma)(m_2)(\Delta\tilde{S}, 1, \sigma) \\ &= \tau_2(m, m)(1, \psi, 1)(\psi(\tilde{S}, S)\Delta, 1, \sigma)(m, m)(1, \psi, 1)(\psi(\tilde{S}, S)\Delta, 1, \sigma) \end{aligned}$$

$$= \tau_2(m, m)(1, \psi, 1)(\psi, 2)(\tilde{S}, S, 1, \sigma)(\Delta, 1)(m, m)(1, \psi, 1)(\psi, 2)(\tilde{S}, S, 1, \sigma)(\Delta, 1)$$

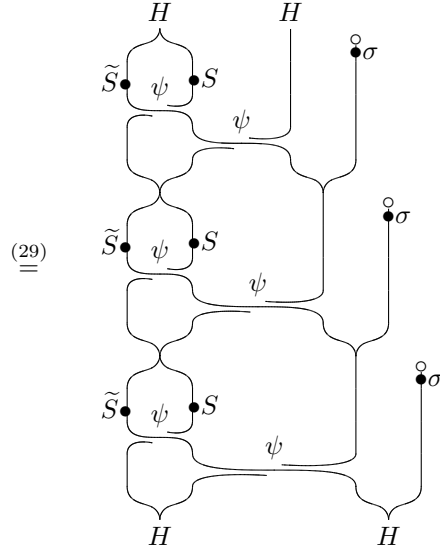

$$\stackrel{(1), (6)}{=} \tau_2(m, m)(1, \psi, 1)(\psi, 2)(\tilde{S}, S, 1, \sigma)(m, m, m)(1, \psi, 3)(\Delta, \Delta, 2)(S, 1, \tilde{S}, \sigma)(1, \psi)(\psi, 1)(\Delta, 1)$$

$$= \tau_2(m, m)(1, \psi, 1)(\psi, 2)(\tilde{S}m, Sm, m, \sigma)(1, \psi, 3)(\Delta S, \Delta, \tilde{S}, \sigma)(1, \psi)(\psi, 1)(\Delta, 1)$$

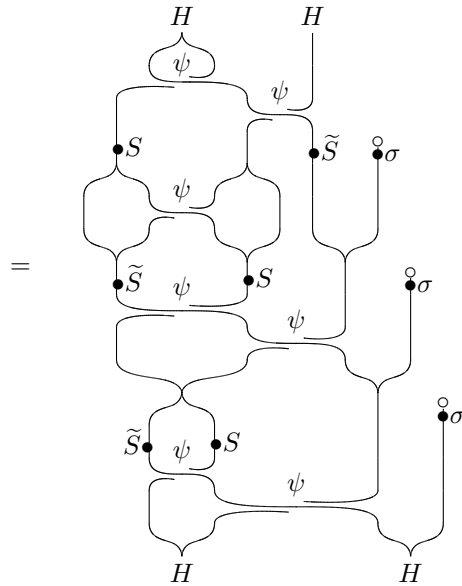



$$\begin{aligned} & \stackrel{(12), (10), (25)}{=} \tau_2(m, m)(1, \psi, 1)(\psi, 2)(m(\tilde{S}, \tilde{S})\psi, m(S, S)\psi, m, \sigma) \\ & (1, \psi, 3)((S, S)\psi\Delta, \Delta, \tilde{S}, \sigma)(1, \psi)(\psi, 1)(\Delta, 1) \end{aligned}$$

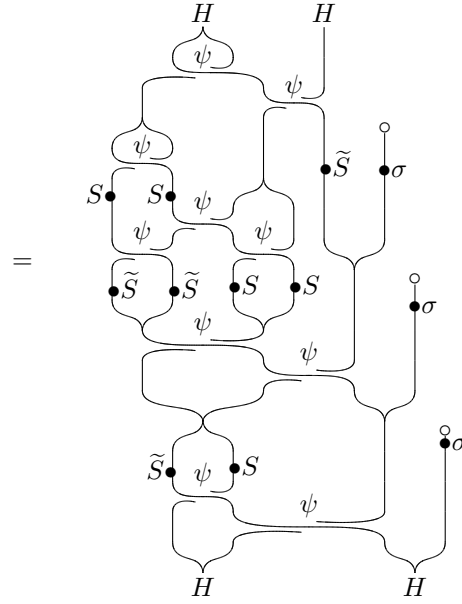

Again, by the same method, using standard identities and properties, including:

$$(1, \psi)(\psi, 1)(1, \psi) = (\psi, 1)(1, \psi)(\psi, 1),$$

one reduces the above diagram to the following one:

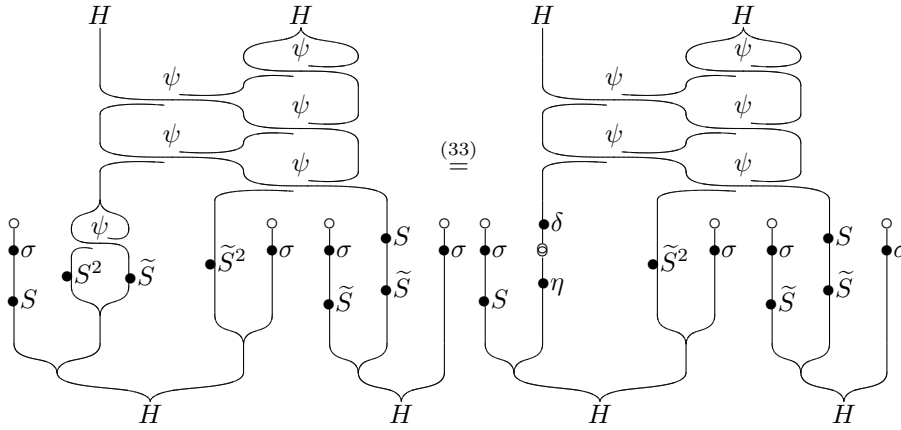

$$\begin{aligned} & = (m(m, 1), m(m, 1))(2, m, 3)(S\sigma, \eta\delta, \tilde{S}^2, \sigma, \tilde{S}\sigma, \tilde{S}S, \sigma) \\ & (1, \psi)(\psi, 1)(1, \psi)(\psi, 1)(1, \psi)(1, \Delta) \end{aligned}$$

$$\begin{aligned}
&= (m(m, 1), m(m, 1))(1, \eta, 4)(1, m, 3)(S\sigma, \tilde{S}^2, \sigma, \tilde{S}\sigma, \tilde{S}S, \sigma) \\
&\quad (\psi)(\delta, 2)(\psi, 1)(1, \psi)(\psi, 1)(1, \psi)(1, \Delta) \\
&= (m(m(1, \eta), 1), m(m, 1))(1, m, 3)(S\sigma, \tilde{S}^2, \sigma, \tilde{S}\sigma, \tilde{S}S, \sigma)(\psi) \\
&\quad (2, \delta)(\psi, 1)(1, \psi)(1, \Delta) \\
&= (m, m(m, 1))(1, m, 3)(S\sigma, \tilde{S}^2, \sigma, \tilde{S}\sigma, \tilde{S}S, \sigma)(\psi)(\psi)(1, \delta, 1)(1, \Delta) \\
&= (m, m(m, 1))(1, m, 3)(S\sigma, \tilde{S}^2, \sigma, \tilde{S}\sigma, \tilde{S}, \sigma)(1, S)\psi^2(1, \delta, 1)(1, \Delta) \\
&= (m, m(m, 1))(1, m, 3)(S\sigma, \tilde{S}^2, \sigma, \tilde{S}\sigma, \tilde{S}, \sigma)\psi^2(1, S)(1, \delta, 1)(1, \Delta) \\
&= (m, m(m, 1))(1, m, 3)(S\sigma, \tilde{S}^2, \sigma, \tilde{S}\sigma, \tilde{S}, \sigma)\psi^2(1, (\delta, S)\Delta) \\
&= (m, m(m, 1))(1, m, 3)(S\sigma, \tilde{S}^2, \sigma, \tilde{S}\sigma, \tilde{S}, \sigma)\psi^2(1, \tilde{S}) \\
&= (m(1, m), m(m, 1))(S\sigma, \tilde{S}^2, \sigma, \tilde{S}\sigma, \tilde{S}, \sigma)(1, \tilde{S})\psi^2 \\
&= (m(1, m)(S\sigma, \tilde{S}^2, \sigma), m(m, 1)(\tilde{S}\sigma, \tilde{S}^2, \sigma))\psi^2
\end{aligned}$$

$$\begin{aligned}
&= \begin{array}{c} \begin{array}{c} H \quad \psi \quad H \\ \overbrace{\hspace{1.5cm}} \\ \psi \\ \overbrace{\hspace{1.5cm}} \\ \begin{array}{c} \sigma \quad \tilde{S}^2 \quad \sigma \quad \sigma \quad \tilde{S}^2 \quad \sigma \\ \cdot \quad \cdot \quad \cdot \quad \cdot \quad \cdot \quad \cdot \\ \downarrow \quad \downarrow \quad \downarrow \quad \downarrow \quad \downarrow \quad \downarrow \\ S \quad \tilde{S} \\ \cdot \quad \cdot \\ \downarrow \quad \downarrow \\ H \quad H \end{array} \end{array} \\ \end{array} \stackrel{(28)}{=} \begin{array}{c} \begin{array}{c} H \quad \psi \quad H \\ \overbrace{\hspace{1.5cm}} \\ \psi \\ \overbrace{\hspace{1.5cm}} \\ H \quad H \end{array} \\ \end{array} \\
&= (1, 1)\psi^2 = \psi^2. \quad \square
\end{aligned}$$

*Remark 7.4.* In general we have for all  $n \neq 0$ :

$$\tau_n^{n+1} = (\psi_{H^{(n-1)}, H})^n$$

which is equal to  $id$ , for all  $n \neq 0$ , iff  $\psi^2 = id$ .

For  $n = 3$  this statement means  $\tau_3^4 = (\psi_{H^2, H})^3$ , which is visualized in the following picture:

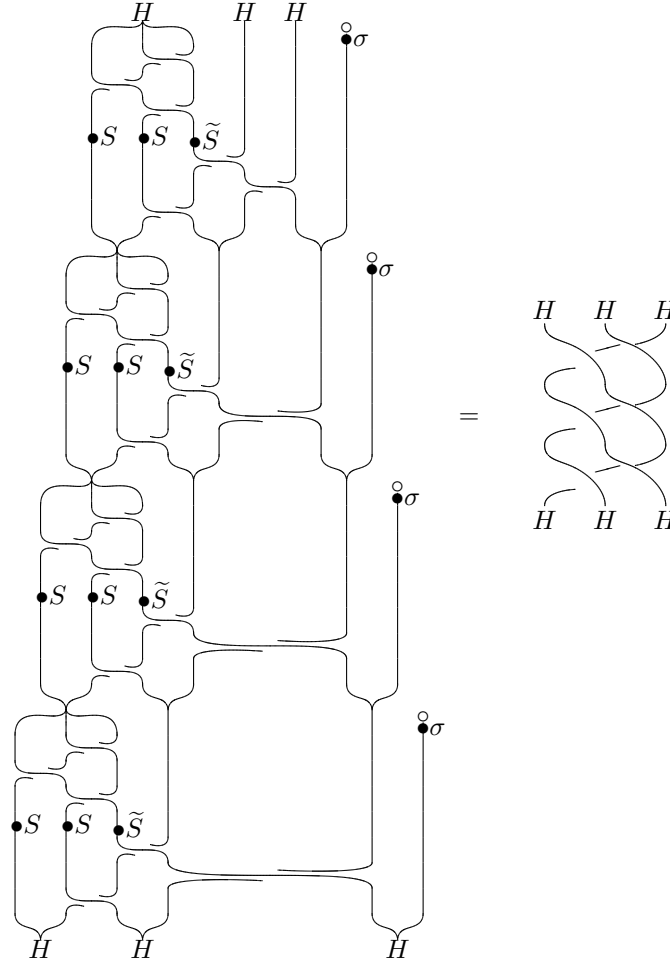

Now we proceed to our last example, the Hopf cyclic cohomology for quasitriangular quasi-Hopf algebras, which was one of the main motivations for this work. One knows that a quasitriangular quasi-Hopf algebra  $(H, R, \Phi, \alpha, \beta)$  is a Hopf algebra in the braided monoidal category of (left)  $H$ -modules [2, 19]. This braided Hopf algebra  $\underline{H}$  has the following structure. As a vector space  $\underline{H} = H$ , with  $H$ -module structure given by conjugation

$$a \triangleright h = a^{(1)} h S(a^{(2)}).$$

The Hopf algebra structure on  $\underline{H}$  is given by [2]:

$$\underline{m}(a, b) = a \cdot b = X_1 a S(x_1 X_2) \alpha x_2 X_3^{(1)} b S(x_3 X_3^{(2)}),$$

with unit  $\beta$ ,

$$\underline{\Delta}(h) = h^{(1)} \otimes h^{(2)} = x_1 X_1 h^{(1)} g_1 S(x_2 R_2 y_3 X_3^{(2)}) \otimes x_3 R_1 \triangleright y_1 X_2 h^{(2)} g_2 S(y_2 X_3^{(1)}),$$

with counit  $\underline{\varepsilon} = \varepsilon$ , and antipode

$$\underline{S}(h) = x_1 R_2 p_2 S(q_1 (X_2 R_1 p_1 \triangleright h) S(q_2) X_3).$$

Here we have used the following notations:

$$\begin{aligned}\Phi &= X_1 \otimes X_2 \otimes X_3, \\ \Phi^{-1} &= x_1 \otimes x_2 \otimes x_3 = y_1 \otimes y_2 \otimes y_3, \\ p_1 \otimes p_2 &= x_1 \otimes x_2 \beta S(x_3), \\ q_1 \otimes q_2 &= X_1 \otimes S^{-1}(\alpha X_3) X_2,\end{aligned}$$

and

$$g_1 \otimes g_2 = \Delta(S(x_1)\alpha x_2)\xi(S \otimes S)(\Delta^{\text{op}}(x_3)),$$

where,

$$\begin{aligned}\xi &= B_1 \beta S(B_4) \otimes B_2 \beta S(B_3), \\ B_1 \otimes B_2 \otimes B_3 \otimes B_4 &= (\Delta \otimes id \otimes id)(\Phi)(\Phi^{-1} \otimes 1).\end{aligned}$$

Let  $(\delta, \sigma)$  be a braided modular pair in involution for  $\underline{H}$ . Using Theorem 7.1 we can associate a para-cocyclic module to  $\underline{H}$ . By passing to subspaces  $\ker(1 - \tau_n^{n+1})$  we obtain a cocyclic module. Therefore we have the following corollary.

**Corollary 7.5.** *For any quasitriangular quasi-Hopf algebra  $(H, R, \Phi, \alpha, \beta)$  endowed with a braided modular pair in involution  $(\delta, \sigma)$ , the complex obtained in Theorem 7.1 defines a Hopf cyclic cohomology for  $H$ , denoted by  $HC_{(\delta, \sigma)}^*(H, R, \Phi, \alpha, \beta)$ .*

## References

- [1] S. E. Akrami, and S. Majid, Braided cyclic cocycles and nonassociative geometry, *J. Math. Phys.* **45** (2004), no. 10, 3883–3911.
- [2] D. Bulacu, and E. Nauwelaerts, Radford’s biproduct for quasi-Hopf algebras and bosonization, *J. Pure Appl. Algebra* **174** (2002), no. 1, 1–42.
- [3] A. Connes, Cohomologie cyclique et foncteurs  $\text{Ext}^n$  (French), (Cyclic cohomology and functors  $\text{Ext}^n$ ) *C. R. Acad. Sci. Paris Sér. I Math.* **296** (1983), no. 23, 953–958.
- [4] A. Connes, Noncommutative differential geometry, *Inst. Hautes Études Sci. Publ. Math.* **62** (1985), 257–360.
- [5] A. Connes, *Noncommutative Geometry*, Academic Press, San Diego, CA, 1994. Available online at <http://alainconnes.org/>.
- [6] A. Connes and H. Moscovici, Hopf algebras, cyclic cohomology and the transverse index theorem, *Comm. Math. Phys.* **198** (1998), no. 1, 199–246.
- [7] A. Connes and H. Moscovici, Cyclic cohomology and Hopf algebras, *Lett. Math. Phys.* **48** (1999), no. 1, 97–108.
- [8] A. Connes, and H. Moscovici, Cyclic cohomology and Hopf algebra symmetry, *Conference Mosh Flato 1999 (Dijon)*, *Lett. Math. Phys.* **52** (2000), no. 1, 1–28.
- [9] P. Deligne, and J. W. Morgan, Notes on supersymmetry (following Joseph Bernstein), *Quantum fields and strings: a course for mathematicians* **1** 41–97. American Mathematical Society, Providence, RI; 1999.

- [10] P. M. Hajac, M. Khalkhali, B. Rangipour, and Y. Sommerhäuser, Stable anti-Yetter-Drinfeld modules, *C. R. Math. Acad. Sci. Paris* **338** (2004), no. 8, 587–590.
- [11] P. M. Hajac, M. Khalkhali, B. Rangipour, and Y. Sommerhäuser, Hopf-cyclic homology and cohomology with coefficients, *C. R. Math. Acad. Sci. Paris* **338** (2004), no. 9, 667–672.
- [12] A. Joyal, and R. Street, The geometry of tensor calculus I, *Adv. Math.* **88** (1991), no. 1, 55–112.
- [13] Ch. Kassel, *Quantum groups*, Graduate Texts in Mathematics 155, Springer-Verlag, New York, 1995.
- [14] M. Khalkhali, and B. Rangipour, A new cyclic module for Hopf algebras, *K-Theory* **27** (2002), no. 2, 111–131.
- [15] M. Khalkhali, and B. Rangipour, Invariant cyclic homology, *K-Theory* **28** (2003), no. 2, 183–205.
- [16] J. L. Loday, *Cyclic homology*, Second edition, Grundlehren der Mathematischen Wissenschaften [Fundamental Principles of Mathematical Sciences], 301, Springer-Verlag, Berlin, 1998.
- [17] S. Mac Lane, *Categories for the working mathematician*, Second edition, Graduate Texts in Mathematics, 5, Springer-Verlag, New York, 1998.
- [18] S. Majid, Algebras and Hopf algebras in braided categories, *Advances in Hopf algebras*, 55–105, *Lecture Notes in Pure and Appl. Math.* **158**, Dekker, New York, 1994.
- [19] S. Majid, *Foundations of quantum group theory*, Cambridge University Press, Cambridge, 1995.
- [20] D. Radford, and J. Towber, Yetter-Drinfeld categories associated to an arbitrary bialgebra, *J. Pure Appl. Algebra* **87** (1993), 259–279.
- [21] N. Saavedra Rivano, Catégories Tannakiennes, *Lecture Notes in Mathematics* **265**, Springer-Verlag, Berlin, 1972.
- [22] V. G. Turaev, Quantum invariants of knots and 3-manifolds, *de Gruyter studies in Mathematics* **18**, W de Gruyter, Berlin, 1994.
- [23] D. Yetter, Quantum groups and representations of monoidal categories, *Math. Proc. Cambridge Philos. Soc.* **108** (1990), no. 2, 261–290.

Masoud Khalkhali [masoud@uwo.ca](mailto:masoud@uwo.ca)

Department of Mathematics, University of Western Ontario, London, Ontario,  
N6A 5B7, Canada

Arash Pourkia [apourkia@uwo.ca](mailto:apourkia@uwo.ca)

Department of Mathematics, University of Western Ontario, London, Ontario,  
N6A 5B7, Canada