

FOLIATIONS AND THE TOPOLOGY OF 3-MANIFOLDS. III

DAVID GABAI

Introduction

A *longitude* of a knot k in S^3 is the unique (up to isotopy) essential simple closed curve λ in $\partial N(k)$ such that λ is homologically trivial in $S^3 - \mathring{N}(k)$. The manifold M is obtained by *zero frame surgery* on k if it is obtained by performing Dehn surgery to the longitude. Note that M is the unique manifold obtained by Dehn surgery on k which is a homology $S^2 \times S^1$ and k viewed in M generates $H_1(M)$.

The main result of this paper is

Theorem 3.1. *If S is a minimal genus Seifert surface for a knot k in S^3 , then there exists a taut finite depth foliation \mathcal{F} of $S^3 - \mathring{N}(k)$ such that S is a leaf of \mathcal{F} and $\mathcal{F} | \partial N(k)$ is a foliation by circles.*

Attaching discs to each leaf of $\mathcal{F} | \partial N(k)$ we obtain

Corollary 8.2. *The manifold M obtained by performing zero frame surgery to a knot k in S^3 possesses a taut finite depth foliation \mathcal{F} such that k (viewed in M) is transverse to \mathcal{F} and intersects every leaf of \mathcal{F} . \mathcal{F} has a compact leaf S of genus equal to the genus of k .*

Applying the work of Alexander, Reeb, Haefliger, Novikov, and Thurston (see [3, 2.5 and 2.8]) we obtain

Corollary 8.3. *If M is obtained by performing zero frame surgery on a knot k in S^3 , then M is prime and $\text{genus } k = \min\{\text{genus } S \mid S \text{ is an embedded, oriented nonseparating surface}\}$.*

Remark. The *Property R* conjecture asserts that zero frame surgery on a nontrivial knot k in S^3 does not yield $S^2 \times S^1$. The *Poenaru* conjecture asserts that zero frame surgery on a nontrivial knot k in S^1 does not yield $S^2 \times S^1 \# (M^3)$. Corollary 8.3 gives positive proofs of these conjectures. Corollary 8.3 was the missing ingredient in the proof of the following result.

Received April 15, 1985 and, in revised form, September 19, 1986. The author was partially supported by grants from the National Science Foundation.

Corollary 8.6 (Poenaru 1974). *If V is a 4-manifold obtained by attaching a 2-handle and a 3-handle to B^4 such that $H_2(V) = 0$, then $V = B^4$.*

Remark (September 1986). M. Scharlemann has found a simplification of our proof of Corollary 8.3 which avoids foliations (see Remark 8.3 $\frac{1}{2}$).

For ten ways to compute the genus of a knot in S^3 consult Theorem 8.8.

The smoothing procedure of [3, §5] allows one to modify the construction of the foliation of Theorem 3.1 to obtain a smooth one if genus $k \neq 1$. Applying a further modification we can eliminate the compact leaves. In the case that genus $k = 1$ these modifications may throw holonomy onto the boundary. Therefore we obtain the following result.

Corollary 8.10. *If k is a knot in S^3 such that genus $k > 1$, and S is a minimal genus Seifert surface for k , then there exists C^∞ , taut foliations \mathcal{F}_i , $i = 1, 2$ of $S^3 - \dot{N}(k)$ such that $\mathcal{F}_i | \partial N(k)$ is a foliation by circles, S is a leaf of \mathcal{F}_1 , and no leaf of \mathcal{F}_2 is compact.*

Tubularizing these foliations near $\partial N(k)$ and attaching a Reeb component yields Corollary 8.11. A C^0 version of this result (for k nontrivial) was obtained in [3].

Corollary 8.11. *If k is a knot in S^3 such that genus $k > 1$, then there exists a C^∞ foliation \mathcal{F} of S^3 with a single Reeb component whose core is isotopic to k .*

The most striking observation in the proof of Theorem 3.1 is that any nice finite depth taut partial foliation constructed on $S^3 - \dot{N}(k)$ extends to a foliation satisfying the conclusions of that result. This is the key ingredient in proving

Corollary 8.19. *k is a fibered knot in S^3 if and only if the manifold M obtained by performing zero frame surgery to k fibers over S^1 .*

Since the trefoil and the figure 8 knots are the only genus one fibered knots in S^3 [8] we obtain

Corollary 8.23. *Surgery on a knot in S^3 yields a torus bundle over S^1 if and only if the surgery is the zero frame one and either k is the trefoil knot or k is the figure 8 knot.*

We assume that the reader is familiar with the results and terminology of [3] and of §0 of [6]. §1 and §2 of [6] are independent of this paper. Because we view this paper as a continuation of *Foliations and the topology of 3-manifolds II*, we begin with §3.

The proof of Theorem 3.1 involves four steps which are respectively carried out in §§3–6. These four steps are precisely stated and put together in §7. The reader is advised to consult §7 for an overview of the proof. Consequences of Theorem 3.1 are given in §8.

The author gratefully thanks M. Scharlemann and T. Kobayashi for their large number of constructive criticisms of the text.

This research was conducted while I spent years at Harvard University, the Institute for Advanced Study in Princeton, the University of Pennsylvania, and the Berkeley Mathematical Sciences Research Institute. The paper was rewritten while at the Institut des Hautes Études Scientifiques. I thank all of these institutions for their hospitality.

3. Longitudinal foliations

The goal of the next five sections is to prove the following theorem.

Theorem 3.1. *If S is a minimal genus Seifert surface for a knot k in S^3 , then there exists a taut finite depth foliation \mathcal{F} of $S^3 - \dot{N}(k)$ such that S is a leaf of \mathcal{F} and $\mathcal{F} | \partial N(k)$ is a foliation by circles.*

Idea of the proof. We attempt to construct \mathcal{F} leaf by leaf. We either completely construct \mathcal{F} or get stuck and must be satisfied with a particularly nice lamination (i.e., partial foliation) \mathcal{L} . This is the content of §3. Now, suppose we get stuck. In §4 we put this lamination into a normal form in S^3 in order to find an essential 2-sphere Q . In §5 we find a planar surface $P \subset \mathcal{L}$ with some remarkable properties. A little combinatorial argument in §6 rules out the coexistence of such P and Q . The entire proof is pieced together in §7.

Definitions 3.2. Let

$$(M, \partial M) \xrightarrow{S_1} (M_1, \gamma_1) \xrightarrow{S_2} \cdots \xrightarrow{S_n} (M_n, \gamma_n)$$

be a sequence of sutured manifold decompositions where ∂M is a union of tori. Define $E_0 = \partial M$. Define E_i to be the union of those components of $E_{i-1} - \dot{N}(S_i)$ which are annuli and tori (i.e., if M_i is viewed as a submanifold of M , then E_i consists of those components of γ_i which are contained in ∂M). The components of E_i are called the *boundary sutures* of γ_i .

More generally if (M, γ) is any sutured manifold and E_0 is a set of components of γ , then any sequence as above (with $(M, \partial M)$ replaced by (M, γ)) yields a sequence E_1, \dots, E_n .

Two sutures A_1, A_2 are *parallel* if there exists a product disc D such that $D \cap A_i \neq \emptyset$ for $i = 1, 2$. A boundary suture e is *tame* if it is parallel to a component of $\gamma - E$.

Notation 3.3. Let (M, γ) be a sutured manifold and let E be a subset of the annular components of γ . Denote by $(\hat{M}, \hat{\gamma})$ the sutured manifold obtained by attaching 2-handles to M along each component of E . We define $\hat{\gamma} = \gamma - E$ and $R(\hat{\gamma})$ to be the natural extension of $R(\gamma)$ to $\partial \hat{M}$. If S is a properly embedded surface in (M, γ) , then denote by \hat{S} the properly embedded surface in \hat{M} obtained by attaching 2-discs to each component of $\partial S \cap E$.

In practice E will be the boundary sutures of γ . For example if

$$(S^3 - \dot{N}(k), \partial N(k)) \xrightarrow{S_1} (M_1, \gamma_1) \xrightarrow{S_2} \dots \xrightarrow{S_n} (M_n, \gamma_n)$$

is a sequence of sutured manifold decompositions such that $\partial S_i \cap \partial M$ is a union of circles for each i and S_1 is a Seifert surface for k , then the corresponding sequence

$$(\hat{M}, \emptyset) \xrightarrow{\hat{S}_1} (\hat{M}_1, \hat{\gamma}_1) \xrightarrow{\hat{S}_2} \dots \xrightarrow{\hat{S}_n} (\hat{M}_n, \hat{\gamma}_n)$$

is a sequence of sutured manifold decompositions of the manifold \hat{M} obtained by performing zero frame surgery (see 8.1) to k .

Lemma 3.4. *Let (M, γ) be a taut sutured manifold. Let E be a subset of annular components of γ . If $0 \neq y \in H_2(\hat{M}, \partial \hat{M})$, then there exists a groomed sutured manifold decomposition $(M, \gamma) \xrightarrow{S} (M_1, \gamma_1)$ such that $[S] = y \cap M \in H_2(M, \partial M)$ and $S \cap E$ is a possibly empty union of simple closed curves.*

If $\partial \hat{M}$ is not a union of 2-spheres, then y can be chosen so that the corresponding S is a connected well-groomed surface and $\partial S \neq \emptyset$.

Proof. To obtain the first part apply Lemma 0.7 of [6] to $y \cap M$. [If T is an embedded surface in \hat{M} such that $y = [T] \in H_2(\hat{M}, \partial \hat{M})$, then $y \cap M$ is represented by $T \cap M$. Now view M as $\hat{M} - \dot{N}$ (properly embedded arcs) and let T intersect these arcs transversely. Since $T \cap E$ is a union of circles and $0 = |T \cap \partial E| = |S \cap \partial E|$, the resulting S intersects E in circles.]

If $\partial \hat{M}$ is not a union of 2-spheres, then apply Lemma 3.8 of [3] to the sutured manifold $(\hat{M}, \hat{\gamma})$ to obtain the class $z \in H_2(\hat{M}, \partial \hat{M})$. z has the property that each boundary component δ of each nonplanar component \hat{V} of $R(\hat{\gamma})$ satisfies $\langle z, \delta \rangle = 0$. Also $\langle z, \delta \rangle \neq 0$ for at most 2 components of $\partial \hat{V}$ if \hat{V} is planar. Let S be a nonseparating component with boundary of the surface obtained by applying Lemma 0.7 of [6] to $(z \cap [M, \partial M]) \in H_2(M, \partial M)$. By [3, Lemma 3.9] if V is a component of $R(\gamma)$, then $S \cap V$ is homologous to a set of parallel curves. An application of [6, Lemma 0.6] now yields the desired well-groomed surface.

Definition 3.5. Let (M, γ) be a taut sutured manifold. Let $\mathcal{D} = \{D_1, \dots, D_n\}$ be a maximal set of pairwise disjoint, pairwise nonparallel, nonboundary parallel product discs in (M, γ) . Let (M', γ') be the taut sutured manifold obtained by decomposing (M, γ) along \mathcal{D} . Define $\hat{C}(M, \gamma) = C(M', \gamma')$, where C is the sutured manifold complexity defined in [3, §4]. \hat{C} is called the *disc reduced sutured manifold complexity* (compare [3, 4.10]). \hat{C} is well defined because another choice of \mathcal{D} would yield a sutured manifold (M'', γ'') which is obtained from (M', γ') by adding and/or deleting product

sutured manifold components. Sutured manifold complexity does not detect product sutured manifold components.

Lemma 3.6. *Let (M_0, γ_0) be a taut connected sutured manifold and let E_0 be a subset of components of γ_0 . Then there exists a well-groomed sequence of sutured manifold decompositions*

$$(M_0, \gamma_0) \xrightarrow{S_1} (M_1, \gamma_1) \xrightarrow{S_2} \cdots \xrightarrow{S_n} (M_n, \gamma_n)$$

such that for $1 \leq i \leq n$:

- (1) S_i is connected, $\partial S_i \neq \emptyset$, and $0 \neq [S_i, \partial S_i] \in H_2(M_{i-1}, \partial M_{i-1})$.
- (2) $E_{i-1} \cap S_i$ is a union of simple closed curves ($E_i, 1 \leq i \leq n$, is as defined in 3.2).
- (3) If $(\hat{M}_n, \hat{\gamma}_n)$ denotes the sutured manifold obtained by attaching 2-handles to (M_n, γ_n) along E_n , then $\partial \hat{M}_n$ is a union of 2-spheres.

Remarks. In our application, Theorem 3.1, (M_0, γ_0) is $(S^3 - \dot{N}(k), \partial N(k))$ decomposed along a minimal genus Seifert surface.

The conclusion of this lemma implies (by the definition of sutured manifold decomposition) that each component of $\partial S_i \cap E_{i-1}$ has the same orientation as some core of E_{i-1} .

Proof. Let

$$(M - \dot{N}(k), \partial N(k)) = (M_0, \gamma_0) \xrightarrow{S_1} (M_1, \gamma_1) \xrightarrow{S_2} \cdots \xrightarrow{S_m} (M_m, \gamma_m)$$

be a sequence of sutured manifold decompositions which satisfy the conclusions of Lemma 3.6 with the possible exception of (3). This sequence satisfies the conclusions of Lemma 3.6 or $\partial \hat{M}_n$ contains a surface of genus ≥ 1 .

By [3, Lemma 4.12] it follows that $\hat{C}(M_i, \gamma_i) \leq \hat{C}(M_{i-1}, \gamma_{i-1})$ for $1 \leq i \leq m$. To complete the proof of Lemma 3.6 we will show that there exists an extension of the sequence by $(M_m, \gamma_m) \xrightarrow{S_{m+1}} \cdots \xrightarrow{S_r} (M_r, \gamma_r)$, where $\hat{C}(M_r, \gamma_r) < \hat{C}(M_m, \gamma_m)$. Since sutured manifold complexity takes values in a well-ordered set the result will follow.

We now prove the lemma by induction on the triple $(\hat{C}(M, \gamma), -\chi(\hat{M}), |\text{nontame boundary sutures}|)$ ordered lexicographically.

Case 1. There exists a properly embedded nonseparating product disc D in M_m such that $D \cap E_m = \emptyset$.

Proof. If D intersects distinct sutures, then extend the sequence by $(M_m, \gamma_m) \xrightarrow{D} (M_{m+1}, \gamma_{m+1})$. If D intersects the same component A of γ , then let C be the product annulus obtained by first gluing a component of $A - D$ to D and then isotoping it slightly to be properly embedded and satisfy $\partial C \subset R(\gamma_m)$.

There now exists a sequence

$$(M_m, \gamma_m) \xrightarrow{C} (M', \gamma') \xrightarrow{F} (M'', \gamma'')$$

where F is a product disc in M'' such that $F \cap A \neq \emptyset$. If both components of ∂C are nonseparating, then our desired extension is obtained by letting $(M_{m+1}, \gamma_{m+1}) = (M', \gamma')$ and letting $(M_{m+2}, \gamma_{m+2}) = (M'', \gamma'')$. $\hat{C}(M_{m+2}, \gamma_{m+2}) = \hat{C}(M_m, \gamma_m)$ but $\chi(\partial \hat{M}_{m+2}) = \chi(\partial \hat{M}_m) + 2$.

It may happen that one or both components of ∂C are separating in $R(\gamma_m)$. We now proceed in a manner reminiscent of [3, Lemma 5.4]. We will consider the case that exactly one component α of ∂C is separating; the other case is similar. The proof is contained in Figure 3.1. Let X be the surface obtained by attaching to C that component J of $R(\gamma_m) - \alpha$ such that $C \cup J$ is oriented and $\bar{J} \cap \alpha \neq \emptyset$. (The arrows in Figure 3.1(a) indicate the transverse orientations of $R(\gamma_m)$ and C .) Isotope X slightly so that X is properly embedded in M_m as in Figure 3.1(b). Now decompose (M_m, γ_m) along X to obtain (M_{m+1}, γ_{m+1}) as in Figure 3.1(c). By decomposing (M_{m+1}, γ_{m+1}) along the product annulus C' we obtain (M', γ') plus the product sutured manifold (B, β) . There now exists a groomed sequence $(M_{m+1}, \gamma_{m+1}) \xrightarrow{D_1} \dots \xrightarrow{D_k} (M_p, \gamma_p)$, where $p = m + 1 + k$, each D_i is contained in $N(B \cup F)$ and is either a product disc disjoint from the boundary sutures or a product annulus. (M_p, γ_p) is obtained from (M'', γ'') by drilling out $r \geq 0$ ($r = 2$ in Figure 3.1(d)) tame boundary sutures which are parallel to the suture C'' of Figure 3.1(d). There will be genus $R_+(\beta)$ annular D_i 's and $|$ nonboundary sutures of $\beta| + 2$ genus $R_+(\beta) - 1$ disc D_i 's. This is our desired extension since $\hat{C}(M_p, \gamma_p) = \hat{C}(M'', \gamma'') = \hat{C}(M_m, \gamma_m)$ but $\hat{M}_p = \hat{M}''$ so $\chi(\partial \hat{M}_p) > \chi(\partial \hat{M}_m)$.

Case 2. There exists a component e of E_m and a properly embedded nonseparating product disc $D \subset M_m$ such that $D \cap \gamma \subset e$.

Proof. If e is parallel (3.2) to the nonboundary suture A , then there is a properly embedded nonseparating product disc $D' \subset M_m$ such that $D' \cap \gamma \subset A$, so invoke Case 1. Otherwise let C be an annulus constructed as in Case 1. If each component of ∂C is nonseparating in $R(\gamma_m)$, then extend our sequence by the decomposition $(M_m, \gamma_m) \xrightarrow{C} (M_{m+1}, \gamma_{m+1})$. After this decomposition e becomes tame, hence the number of nontame sutures has been reduced. Note that $\hat{C}(M_m, \gamma_m) = \hat{C}(M_{m+1}, \gamma_{m+1})$ and $\chi(\partial \hat{M}_m) = \chi(\partial \hat{M}_{m+1})$.

Now suppose that some component α of ∂C separates. For simplicity assume that α is the only one that does. Proceed as in Case 1 (in Figure 3.1 replace the suture A by e) to construct the surface X and the decomposition $(M_m, \gamma_m) \xrightarrow{X} (M_{m+1}, \gamma_{m+1})$. As before, by decomposing (M_{m+1}, γ_{m+1}) along the product annulus C' we obtain the product sutured manifold (B, β) plus

(M', γ') , the sutured manifold obtained by decomposing (M_m, γ_m) along C . We now obtain the groomed sequence

$$(M_m, \gamma_m) \xrightarrow{X} (M_{m+1}, \gamma_{m+1}) \xrightarrow{D_1} \cdots \xrightarrow{D_k} (M_p, \gamma_p),$$

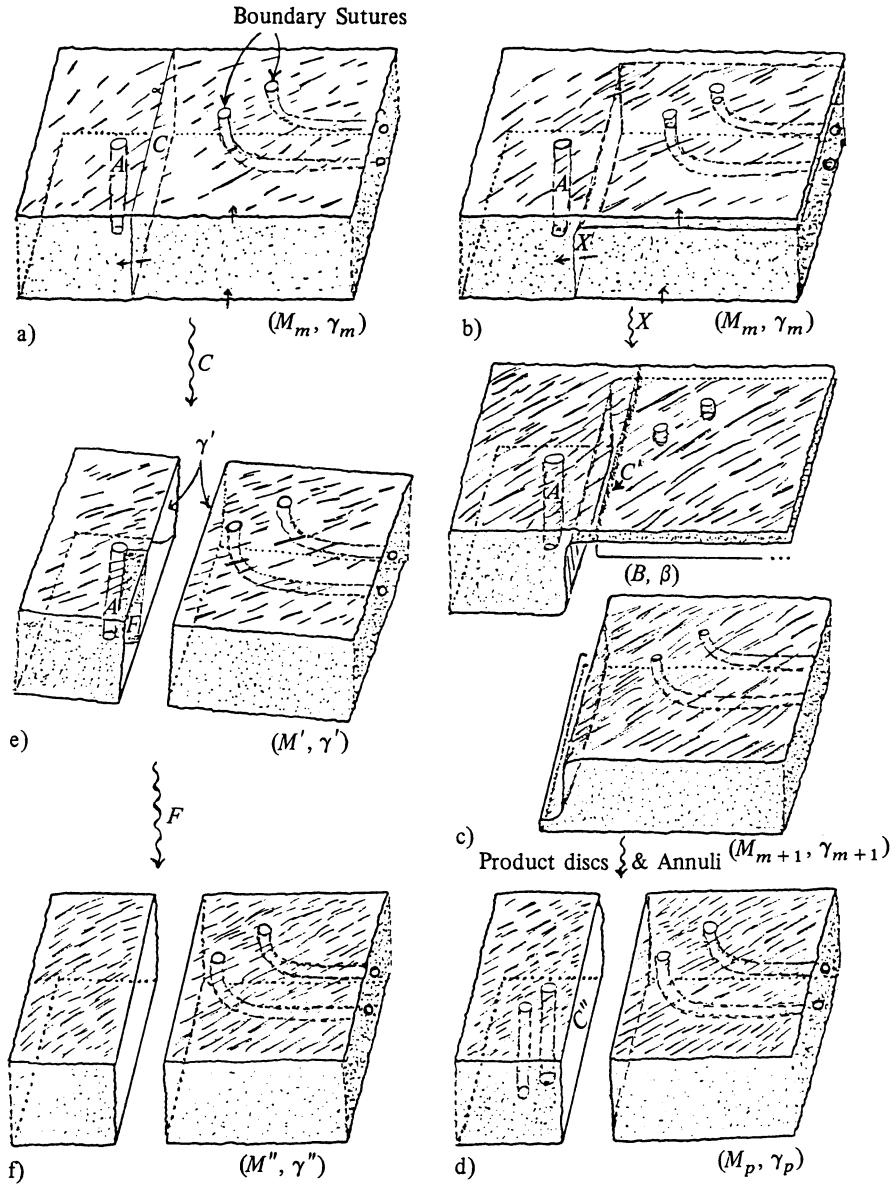

FIGURE 3.1

where $p = m + 1 + k$, each D_i is contained in $N(B)$ and is either a product annulus or product disc disjoint from the boundary sutures. There will be genus $R_+(\beta)$ annular D_i 's and $|\text{nonboundary sutures of } \beta| + 2 \text{ genus}(R_+(\beta)) - 1$ disc D_i 's. If $k \neq 0$, then (M_p, γ_p) is obtained from (M', γ') by drilling out $r \geq 0$ tame boundary sutures and $\hat{C}(M_p, \gamma_p) = \hat{C}(M', \gamma') = \hat{C}(M_m, \gamma_m)$, $\hat{M}_p = \hat{M}'$ so $\chi(\partial \hat{M}_p) = \chi(\partial \hat{M}_m)$ but the number of nontame sutures has been reduced. If $k = 0$, then $\hat{C}(M_p, \gamma_p) = \hat{C}(M_{m+1}, \gamma_{m+1})$ but $\chi(\partial \hat{M}_p) = \chi(\partial \hat{M}_m) + 2$.

Case 3. Neither Case 1 nor Case 2 hold.

Proof. Apply Lemma 3.4 to (M_m, γ_m) to obtain the sutured manifold decomposition $(M_m, \gamma_m) \xrightarrow{S} (M_{m+1}, \gamma_{m+1})$. We will now show that $\hat{C}(M_{m+1}, \gamma_{m+1}) < \hat{C}(M_m, \gamma_m)$. Let $\mathcal{D} = \{D_1, \dots, D_r\}$ be a maximal set of pairwise disjoint, pairwise nonparallel, nonboundary parallel, properly embedded product discs in M_m . Since (M_{m+1}, γ_{m+1}) is taut, S can be isotoped $\text{rel } \partial S \cap \gamma$ so that each component of $\mathcal{D} \cap M_{m+1}$ is a product disc in (M_{m+1}, γ_{m+1}) . (If some component was not a product disc, then some component is a compressing disc for $R(\gamma_{m+1})$.) Let S' be the surface obtained from S by doing boundary compressions to curves of $\mathcal{D} \cap S$ which appear as in Figure 3.2(a) using the indicated discs.

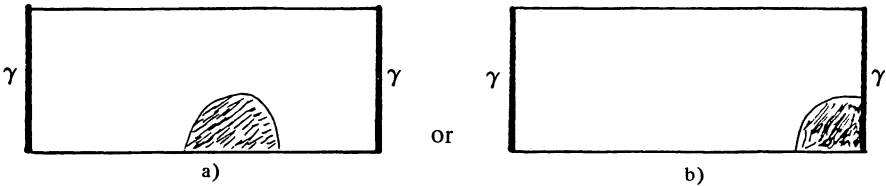

FIGURE 3.2

Now isotope S' slightly near γ , as in Figure 3.2(b) to remove arcs of $S' \cap \gamma$ which have both endpoints in the same component of $\partial \gamma$. (Such arcs would have been created if one of the arcs of $S \cap \mathcal{D}$ which was compressed away intersected γ .) Our new S' intersects \mathcal{D} in only “vertical” and “horizontal” arcs. We therefore have the commutative diagram of Figure 3.3.

Here \mathcal{E} is a set of product discs (one for each boundary compression of S), $R = N \cap S'$, and \mathcal{F} is a maximal set of pairwise disjoint, pairwise nonparallel, nonboundary parallel, properly embedded product discs in (N', γ') . By definition $\hat{C}(M_m, \gamma_m) = \hat{C}(N, \delta)$ and $\hat{C}(M_{m+1}, \gamma_{m+1}) = \hat{C}(N'', \delta'')$. The proof of Theorem 4.2 of [3] shows that $\hat{C}(N'', \delta'') < \hat{C}(N, \delta)$; hence, $\hat{C}(M_{m+1}, \gamma_{m+1}) < \hat{C}(M_m, \gamma_m)$ if we can prove the following:

Claim. $0 \neq [R] \in H_2(N, \partial N)$.

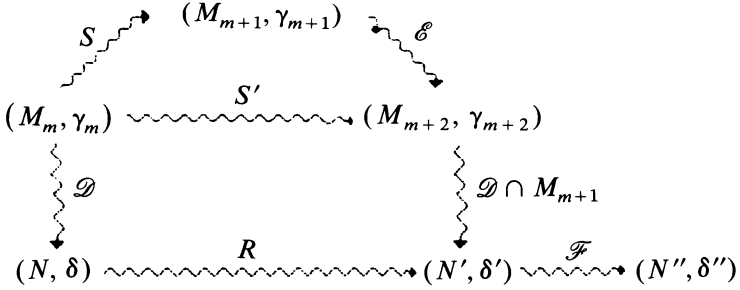

FIGURE 3.3

Proof of Claim. Construct a graph H as follows. The vertices of H are the components of γ_m . The edges of H are the elements of \mathcal{D} . An edge connects the components of γ_m which it intersects. For each component of H construct a maximal tree. Let J be the union of the edges of these maximal trees. Since S' intersects E_m in circles and each maximal tree (by Case 1) contains at most one nonboundary suture, S' is homologous in $H_2(M_m, \partial M_m)$ to a surface T such that $T \cap (J \cup E_m) = \emptyset$ and T is nonseparating in $P = M_m - \dot{N}(J)$.

View (N, δ) as the result of the two sutured manifold decompositions

$$(M_m, \gamma_m) \xrightarrow{J} (P, \lambda) \xrightarrow{B} (N, \delta),$$

where $B = \mathcal{D} - J$. Since neither Case 1 nor Case 2 holds, each component of B is separating in P . Therefore $T - \dot{N}(B) = T \cap N$ is nonseparating in N . Since $[T \cap N] = [R] \in H_2(N, \partial N)$ we conclude that $0 \neq [R]$. q.e.d.

Our interest in finding a well-groomed sutured manifold hierarchy of $(M, \partial M)$ whose decomposing surfaces intersect ∂M in circles is exhibited in the following result.

Lemma 3.7. *Let*

$$(M, \partial M) \xrightarrow{S_1} (M_1, \gamma_1) \xrightarrow{S_2} \dots \xrightarrow{S_n} (M_n, \gamma_n)$$

be a well-groomed sutured manifold hierarchy such that $S_{i+1} \cap E_i$ is a properly embedded union of simple closed curves for $0 \leq i \leq n - 1$. Then there exists a finite depth taut foliation \mathcal{F} of M such that S_1 is a leaf of \mathcal{F} and $\mathcal{F} | \partial M$ is a foliation by circles.

Proof. The hypothesis of the lemma is what is needed to invoke the construction of \mathcal{F}_0 on [3, pp. 471–473]. This construction yields a taut foliation \mathcal{F} on M such that $\mathcal{F} | \partial M$ has no Reeb components. By construction

S_1 is a leaf of \mathcal{F} . Applying the construction with the hypothesis of the E_i 's yields the property that $\mathcal{F} \mid \partial M$ is a foliation by circles. Applying the construction with the hypothesis that the hierarchy is well groomed yields the property that \mathcal{F} is of finite depth. q.e.d.

We now prove a sharper version (replace well groomed by groomed) of Lemma 3.7. This version shows that finite depth foliations are quite a bit more plentiful than first imagined in [3]. This section is not needed to prove Theorem 3.1.

Definitions 3.8. Let \mathcal{F} be a codimension-1 transversely oriented foliation on the sutured manifold (M, γ) . Recall that a leaf of \mathcal{F} is of *depth* 0 if it is compact. Having defined the depth $< p$ leaves we say that a leaf L is depth p if it is proper (i.e., the subspace topology on L equals the leaf topology), L is not of depth $< p$, and $\bar{L} - L \subset$ (union of depth $< p$ leaves). If \mathcal{F} contains nonproper leaves, then the depth of a leaf may not be defined.

Since a foliation \mathcal{F} on a sutured manifold (M, γ) is in practice the restriction of a foliation \mathcal{F}' on a larger manifold, it may happen that a depth r leaf of \mathcal{F} may be contained in a depth $r' > r$ leaf of \mathcal{F}' . This motivates the following definition.

Let \mathcal{F} be a foliation on (M, γ) . A *pseudo-depth* function is a function $f: M \rightarrow \{0, 1, \dots, k\}$, $k < \infty$, such that the sets $f^{-1}(i) = F_i$ have the following properties. F_i is a union of leaves of \mathcal{F} . If $i < k$, then F_i is a proper set of leaves (i.e., the subspace topology on F_i equals the leaf topology on F_i). F_0 is a compact set containing $R(\gamma)$ and $\bar{F}_i - F_i \subset f^{-1}(\{0, \dots, i - 1\})$. F_i is called the leaf of *pseudo-depth* i , and k is called the pseudo-depth of \mathcal{F} and f .

A pseudo-depth function is *full* if the restriction of f to each properly embedded interval I in γ which is transverse to \mathcal{F} has the following property. Let $I_i = I \cap F_i$. If $\alpha \in I_i$ and $i < k$, then $\alpha \in \bar{I}_{i+1}$. If α is an interior point of I , then points of I_{i+1} limit on α from both sides of α .

Let $f_k: I = [0, 1] \rightarrow \{0, 1, \dots, k\}$ denote the "standard" full pseudo-depth function, i.e. $f_k^{-1}(0) = \{0, 1\}$, $f_k^{-1}(1) = \{\dots, \frac{1}{8}, \frac{1}{4}, \frac{1}{2}, \frac{3}{4}, \frac{7}{8}, \dots\}$, etc. In a similar way one can define the standard depth function $f_{k,p}$ with p interior compact leaves. Here view $I = [0, p]$ and define $f_{k,p}: I \rightarrow \{0, 1, \dots, k\}$ by $f_{k,p}(x) = f_k(y)$ if $x = y + n$, $n \in \mathbb{Z}$. Note that the standard full pseudo-depth function of depth $k + 1$ could be defined by $f_{k+1}: [-\infty, \infty] \rightarrow \{0, 1, \dots, k + 1\}$ by

$$f_{k+1}(x) = \begin{cases} 1 + f_k(y) & \text{if } x = y + n, n \in \mathbb{Z}, \\ 0 & \text{if } x \in \{-\infty, \infty\}. \end{cases}$$

Lemma 3.9. *If the sutured manifold (M, γ) possesses a foliation \mathcal{F} and a pseudo-depth function, then \mathcal{F} is of finite depth.*

Lemma 3.10. *Let $(M, \gamma) \xrightarrow{T} (M', \gamma')$ be a groomed sutured manifold decomposition. Let E be a subset of the annular components of γ and let T have the property that $T \cap E$ is a union of circles. Let E' be the subset $E - \mathring{N}(T)$ of γ' . If (M', γ') possesses a taut foliation \mathcal{F}' such that $\mathcal{F}'|_{E'}$ is a foliation by circles and a full pseudo-depth k function f' , then (M, γ) possesses a finite depth taut foliation \mathcal{F} such that $\mathcal{F}|_E$ is a foliation by circles and a full pseudo-depth $k' \in \{k, k + 1\}$ function f . Furthermore if $\partial T \subset \gamma$, then T will be a leaf of \mathcal{F} .*

Proof. \mathcal{F} will be the foliation obtained by applying the principles of the constructions on [3, pp. 471–477].

Case 1. $\partial T \subset \gamma$.

Proof. In this case (M, γ) is obtained by gluing components of $R(\gamma')$ together. The foliation \mathcal{F} is obtained by identifying leaves of \mathcal{F}' . f' naturally extends to a pseudo-depth k function f on M . Since a properly embedded interval in γ transverse to \mathcal{F} is a union of properly embedded intervals of γ' transverse to \mathcal{F}' , it follows that f is a full pseudo-depth function.

Case 2. $\partial T \cap R(\gamma) \neq \emptyset$. For simplicity we will consider the case that ∂T intersects a unique component R of $R(\gamma)$.

As noted in [3] (see Figures 5.2(a), 5.7(a)) M is topologically obtained by gluing together the surfaces $T^+ \subset R_+(\gamma')$ and $T^- \subset R_-(\gamma')$.

Case 2A. ∂T intersects R in circles.

Proof. Glue T^+ to T^- (see [3, Figure 5.2]) and then apply the construction of [3, Case 2, p. 471] to extend \mathcal{F}' to the finite depth foliation \mathcal{F}^* . Since each leaf of $\mathcal{F}^* - R$ is an extension of a leaf of \mathcal{F}' , f' induces a function $f^*: M \rightarrow \{0, 1, \dots, k + 1\}$ by $f^*(R) = 0$ and $f^*(x) = f'(y) + 1$ if x lies on the same leaf as y . Let $V = R(\gamma) - R$. Let \mathcal{G} be the product foliation on $V \times [0, \infty]$. Let $g: [0, \infty] \rightarrow \{0, 1, \dots, k + 1\}$ be the restriction of the function f_{k+1} which was defined in 3.8. Now glue $V \times 0$ to V . Let \mathcal{F} be the foliation on (M, γ) defined by identifying the leaves V and $V \times 0$ of \mathcal{G} and \mathcal{F}^* . These foliations induce a full finite depth function f on (M, γ) as follows:

$$f(x) = \begin{cases} g(x) & \text{if } x \in V \times [0, \infty], \\ f^*(x) & \text{if } x \in M - V \times [0, \infty]. \end{cases}$$

Case 2B. ∂T intersects R in arcs.

Proof. Construct the foliation \mathcal{F}^* on (M, γ) by applying with one modification the construction of [3, Case 3, pp. 475–477]. In this discussion notation will be as in those pages. That construction involved first gluing T^+ to

T^- to obtain a partial foliation \mathcal{X} on M . Each leaf on \mathcal{X} is a quotient of leaves of \mathcal{F}' (see [3, Figures 5.6 and 5.7]). Therefore f' induces a map $h: M \rightarrow \{0, 1, \dots, k + 1\}$ by $h(x) = f'(x) + 1$. The second step of the construction involves attaching to M the set $J' \times [1, \infty]$ with the product foliation. Let \mathcal{X} be the extended partial foliation. Extend h over $J' \times [1, \infty]$ to h by $h(x, t) = f_{k+1}(t)$. Now fill in the ditches $\beta_m \times I \times I$ (Figure 5.7(b)) to create our \mathcal{F}^* in such a way that h extends to a function f^* constant on leaves of \mathcal{F}^* . Extend \mathcal{F}^* and f^* to \mathcal{F} and f as in Case 2A. q.e.d.

Applying several applications of this lemma we obtain

Lemma 3.11. *Let*

$$(M, \partial M) \xrightarrow{S_1} (M_1, \gamma_1) \rightsquigarrow \dots \rightsquigarrow (M_n, \gamma_n)$$

be a groomed sutured manifold hierarchy such that if $S_{i+1} \cap E_i$ is a properly embedded union of simple closed curves for $0 \leq i \leq n - 1$, then there exists a finite depth taut foliation \mathcal{F} of M such that S_1 is a leaf of \mathcal{F} and $\mathcal{F} \upharpoonright \partial M$ is a foliation by circles.

4. Finding an essential 2-sphere in S^3

This section is organized as follows. In (A) we define the notion of a thin knot presentation and show how it can be used to find essential 2-spheres in S^3 . In (B) we define the notion of lamination and branched surface in normal form in S^3 . We show how branched surfaces and laminations arise from sequences of sutured manifold decompositions. In (C) we show that a lamination arising from a groomed sequence of sutured manifold decompositions can be put into normal form by a finite sequence of compactly supported isotopies. This lamination will be carried by a branched surface in normal form which arose from a (possibly different) groomed sutured manifold sequence. In (D) we will generalize the argument of (A) to show that given an incompressible lamination in normal form, there exists an essential 2-sphere Q which intersects this lamination in an essential way. In particular if this lamination arose from a groomed sutured manifold sequence, then Q will essentially intersect the final sutured manifold. In (E) we give a generalization applicable in special cases.

I would like to thank William Thurston for pointing out that my original notion of a minimal complexity knot presentation was essentially the notion of being thin.

(A) Thin knot presentations.

Convention 4.1. Once and for all pick two distinct points x and y in S^3 . Fix $z \in S^2$. Identify $(S^2 - z) \times \mathbb{R}$ with \mathbb{R}^3 in a canonical way so that the \mathbb{R} factor corresponds to the z axis. Define the *height function* $h: S^3 - \{x, y\} = S^2 \times \mathbb{R} \rightarrow \mathbb{R}$ to be the projection onto the second factor. The *level 2-sphere* (resp. *level plane*) at height α , denoted Q_α , is the surface $S^2 \times \alpha$ (resp. $(S^2 - z) \times \alpha = \mathbb{R}^2 \times \alpha$). Let \mathcal{H} denote the fibration of \mathbb{R}^3 by level planes.

Definitions 4.2. A knot k is *generically embedded* in S^3 if $k = f(S^1)$, where $f: S^1 \rightarrow S^3$ is an embedding such that the height function $h \circ f$ is a Morse function with $2b$ critical points which occur at discrete levels. Such an f is called a *generic presentation*. We view isotopic knots as being the same knot.

Define the *width* $w(k)$ of k to be $w(k) = \min\{\frac{1}{2}\sum|Q_i \cap f(S^1)| \mid f \text{ is a generic presentation of } k \text{ and } Q_1, Q_2, \dots, Q_{2b-1} \text{ are level 2-spheres, one located between each critical level}\}$.

A *thin* presentation of k is a presentation which realizes the width of k . The width can be computed explicitly as follows. Let M_1, \dots, M_b and m_1, \dots, m_b be the local maxima and minima of $h \circ f$ where f is a thin presentation of k . Let

$$T(k) = \sum_{i=1}^b \sum_{j=1}^b \epsilon(i, j), \quad \text{where } \epsilon(i, j) = \begin{cases} 1 & \text{if } m_i < M_j \\ 0 & \text{if } m_i > M_j. \end{cases}$$

Proposition 4.3. $w(k) = 2T(k) - b^2$.

Proof. Pull down on the local minima to obtain a new presentation such that every local maximum lies above every local minimum. The width of each term of the resulting sequence of knot presentations is increased by 2 each time a minimum is pushed below a maximum. The width of the final presentation is

$$\frac{1}{2}(2 + 4 + \dots + 2(b - 1) + 2b + 2(b - 1) + \dots + 2) = b^2;$$

hence, $w(k) = b^2 - 2(b^2 - T(k)) = 2T(k) - b^2$. q.e.d.

The following lemma and proof illustrate the key ideas in finding the essential 2-sphere in S^3 .

Lemma 4.4. *Let k be a knot in a thin presentation in S^3 . Let P be a properly embedded surface in $S^3 - \mathring{N}(k)$ such that ∂P is not a union of meridians. Then one can isotope P and find a horizontal 2-plane Q such that Q is transverse to P and each arc component of $Q \cap P$ is essential in P .*

If P is boundary incompressible (resp. incompressible), then each arc (resp. closed) component of $P \cap Q$ is an essential curve in $Q - \mathring{N}(k)$.

Proof. First isotope P in a neighborhood of ∂P so that P is defined locally near $N(k)$ as follows. If $x \in k$ is a local maximum or minimum of k , then there exists a neighborhood V_x of x such that each component of $V_x \cap P$ appears exactly as in Figure 4.1(a) or 4.1(b). If $y \in k - \cup(V_x\text{'s})$, then there exists a neighborhood V_y of y such that each component of $V_y \cap P$ appears exactly as in Figure 4.1(c).

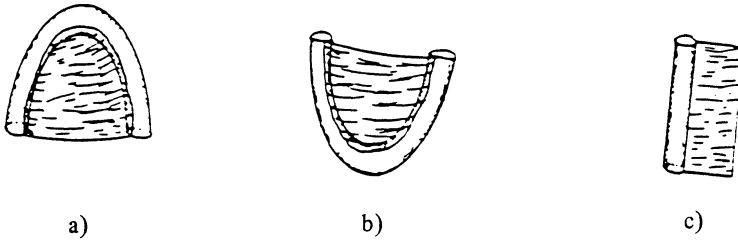

FIGURE 4.1

Now isotope P slightly so that P is transverse to \mathcal{H} except at a finite number of center and saddle tangencies. $x \in P$ is a *saddle* tangency if $N(x) \cap P$ appears as a saddle embedded in S^3 as in Figure 4.8(a). $x \in P$ is a *center* tangency if $N(x)$ appears as a local maximum or minimum (compare Figures 4.8(b), (c)). Assume that all such tangencies are at distinct levels. Let Q_α denote the 2-sphere at height α . Let b denote the height of the highest (biggest) local minimum of k and let s denote the height of the lowest (smallest) local maximum of k which is greater than b .

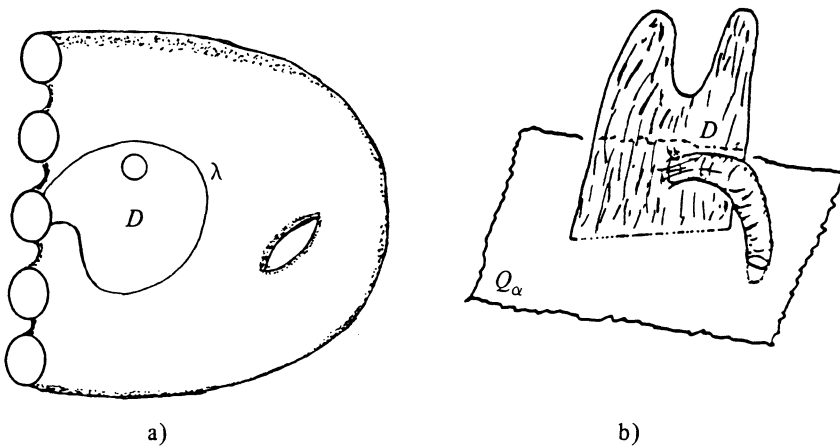

FIGURE 4.2

Let $Q = Q_\alpha$ be such that $b < \alpha < s$ and P is transverse to Q . Suppose that λ is an arc component of $P \cap Q$. If λ is an inessential arc in P such that $D \subset P$ (Figure 4.2(a)), the corresponding boundary compressing disc contains no other such inessential arcs, then D viewed in S^3 appears as in Figure 4.2(b). In particular $D \cap k$ lies either above Q_α or below Q_α . If such a λ exists with Q_α lying below (resp. above) $D \cap k$, then call Q_α a *low plane* (resp. *high plane*) and D a *high disc* (resp. *low disc*). Let

$$B = \{\alpha \in [b, s] \mid Q_\alpha \text{ is a high plane}\}, \quad S = \{\alpha \in [b, s] \mid Q_\alpha \text{ is a low plane}\}.$$

Claim. $[b, s] \neq \bar{B} \cup \bar{S}$.

Proof of Claim. If U is an open subinterval of $[b, s]$ such that P is transverse to Q_α for $\alpha \in U$, then either $U \subset B$ or $U \cap B = \emptyset$. The analogous situation holds for S . Since P has been put into a standard form near $N(k)$, $b \in B$ and $s \in S$. Therefore, if the claim fails, there exists an α such that Q_α is tangent to P , $a \in B$ for $a \in (\alpha - \epsilon, \alpha)$, and $a \in S$ for $a \in (\alpha, \alpha + \epsilon)$ for some

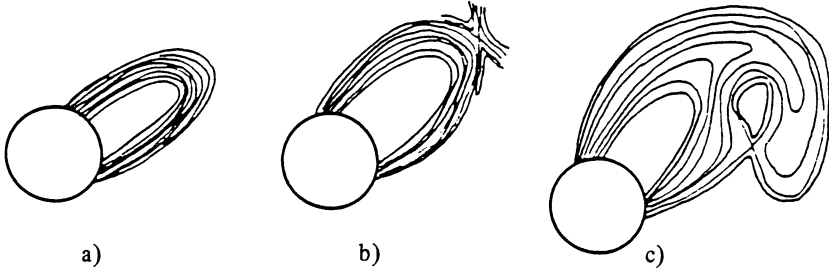

FIGURE 4.3

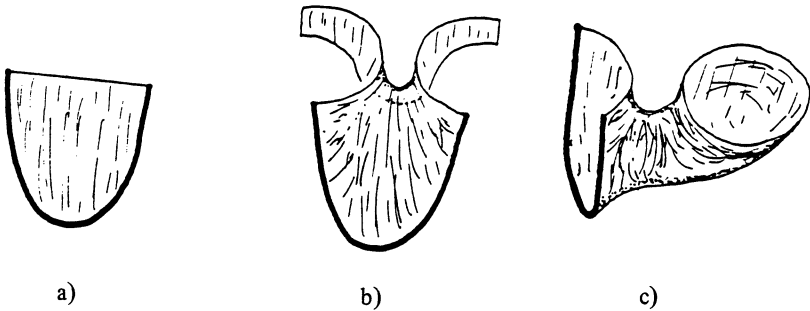

FIGURE 4.4

small ε . There exists a (singular) foliation \mathcal{C} of P induced from the height function h of S^3 . The leaves of \mathcal{C} can be viewed either as level curves of h or as the intersections of P with level planes. There exists a function $f_b: (\alpha - \varepsilon, \alpha] \times I \rightarrow P$ so that if $a < \alpha$, then $f_b(a \times I)$ is a level curve which is the frontier of a low disc D_a . These low discs satisfy $D_a \subset D_c$ if $a < c$. The limit arc $f_b(\alpha \times I)$ is either smooth (Figure 4.3(a)), pinched (Figure 4.3(b)), or squeezed (Figure 4.3(c)). The corresponding limiting low “disc” D_b viewed in S^3 is either smooth, pinched, or squeezed (Figure 4.4(a), (b), (c)). The analogous discussion holds for the function $f_s: [\alpha, \alpha + \varepsilon) \times I \rightarrow P$ which has the property that $f_s(a \times I)$ is the frontier of a high disc D_a if $a > \alpha$ and $f_s(a \times I) \subset Q_\alpha$. Let D_s be the limiting high disc. Note that D_s and D_b cannot both be squeezed. It follows that either k is unknotted or one can find a thinner presentation of k . Situations when both D_s and D_b are smooth or pinched are given in Figure 4.5. q.e.d.

If $\alpha \in [b, s] - \overline{B} \cup \overline{S}$, such that Q_α is transverse to P , then Q_α is our desired plane.

If P is boundary incompressible, then each arc component of $P \cap Q_\alpha$ is essential in $Q_\alpha - \dot{N}(k)$. If P is incompressible, then an isotopy of P eliminates circles which bound discs in $Q_\alpha - \dot{N}(k)$.

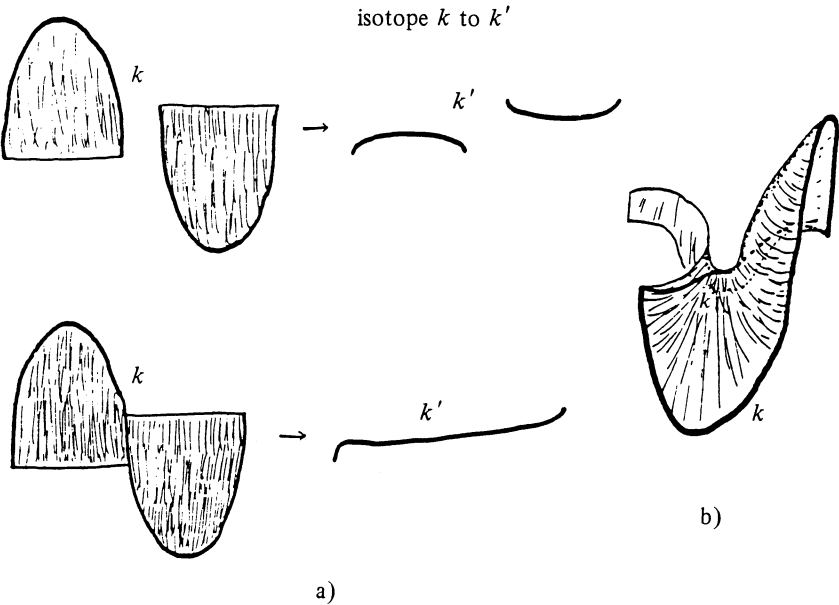

FIGURE 4.5

(B) Branched surfaces, laminations, and sutured manifolds.

Definition 4.5. A p -dimensional lamination \mathcal{L} of an n -dimensional manifold M is a decomposition of a closed subspace N of M into a disjoint union of connected subsets $\{L_\alpha\}$ called leaves of the lamination with the following property. Every point in M has a neighborhood U and a system of local coordinates $x = (x_1, \dots, x_n): U \rightarrow \mathbb{R}^n$ such that for each leaf L_α each component of $U \cap L_\alpha$ is of the form $\{y \in U \mid x_1(y) = \text{constant}, \dots, x_{n-p}(y) = \text{constant}\}$. These components form a basis for the topology of \mathcal{L} . In what follows, all leaves of laminations will have the property that the leaf topology will equal the subspace topology. Also all laminations will be 2-dimensional and transversely oriented in oriented 3-manifolds, hence will be oriented.

We will abuse notation by identifying a lamination \mathcal{L} with the set of points of M which lie in leaves of \mathcal{L} . It will be clear from context which topology (subspace or leaf) on \mathcal{L} we are using.

Definition 4.6. A leaf of a lamination is of *depth 0* if it is compact. Having defined the depth $< p$ leaves we say that a leaf L is *depth p* if it is proper (i.e., the subspace topology on L equals the leaf topology), L is not of depth $< p$, and $\bar{L} - L \subset$ (union of depth $< p$ leaves). If the depth of each leaf is defined, then the depth of the lamination is the depth of the maximal depth leaf. The depth of a leaf or of a lamination is not in general well defined.

Example 4.7. If \mathcal{F} is a foliation on a manifold M , then \mathcal{F} restricted to any saturated closed subset is a lamination. In particular if \mathcal{F} is finite depth, then for each integer r , the union of depth $\leq r$ leaves forms a finite depth lamination on M .

The following is closely related to the notion of a finite depth lamination.

Definitions 4.8. A *branched surface* B in a 3-manifold M is a subspace $B \subset M$ whose local models appear as in Figure 4.6. Note that each point of B has a well-defined tangent plane. In all our subsequent discussions B will possess a *transverse orientation*. Since all manifolds under discussion are oriented, this transverse orientation induces an orientation on B . In the language of [2], B has a product neighborhood $N(B)$ called a *fibered neighborhood* (Figure 4.7(a), (b)). $N(B)$ possesses an oriented foliation \mathcal{V} by intervals and B is



FIGURE 4.6

obtained from $N(B)$ by contracting each leaf of \mathcal{V} to a point. $\partial N(B) = \partial_h N(B) \cup \partial_v N(B)$ where $\partial_h N(B)$ is the subset of $\partial N(B)$ transverse to \mathcal{V} and $\partial_v N(B)$ is the subset tangent to \mathcal{V} . A lamination \mathcal{L} is *carried* by a branched surface B if there exists a fibered neighborhood $N(B)$ of B such that $\mathcal{L} \subset N(B)$ and \mathcal{L} is transverse to \mathcal{V} . \mathcal{L} is *fully carried* by B if \mathcal{L} is carried by B and each leaf of \mathcal{V} nontrivially intersects \mathcal{L} . If B carries \mathcal{L} , then the transverse orientation on B induces a transverse orientation on \mathcal{L} .

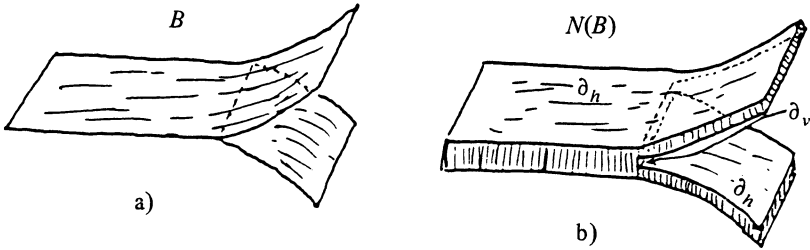

FIGURE 4.7

Definition 4.9. A branched surface B in $S^3 - \dot{N}(k)$ is in *normal form* if:

- (1) k is generically embedded.
- (2) The local behavior of B near $N(k)$ is exactly as in Figure 4.1.
- (3) B is transverse to the horizontal planes except at isolated saddles (Figure 4.8(a)) or at centers possessing neighborhoods which encapsulate local maxima or minima of k (Figure 4.8(b), (c)).
- (4) If Q is a horizontal plane, then $Q \cap B$ contains no smooth circle C which bounds a disc in $Q - B$ unless there exists a center of B whose encapsulating neighborhood contains C .
- (5) The points z_1, \dots, z_r of tangency of B with \mathcal{H} occur at discrete levels l_1, \dots, l_r , distinct from the maxima and minima of k . If l_i is the level of a local maximum z_i of B and M is the height of the maximum y of k encapsulated by a neighborhood of z_i , then $M < l_j < l_i$ implies that z_j is a local maximum possessing a neighborhood which encapsulates y . The analogous situation exists at local minima.
- (6) The height function of each component of the branch locus describes a Morse function. Critical points occur at discrete levels distinct from the l_i 's and the critical points of k . The branch locus is disjoint from $N(N(k))$, neighborhoods of saddle tangencies of B with \mathcal{H} , and from neighborhoods of discs which encapsulate critical points of k (i.e., the branch locus stays away from the local models drawn in Figure 4.7).

Definition 4.10. A lamination \mathcal{L} in $S^3 - \dot{N}(k)$ is in *normal form* if:

- (1) k is generically embedded.

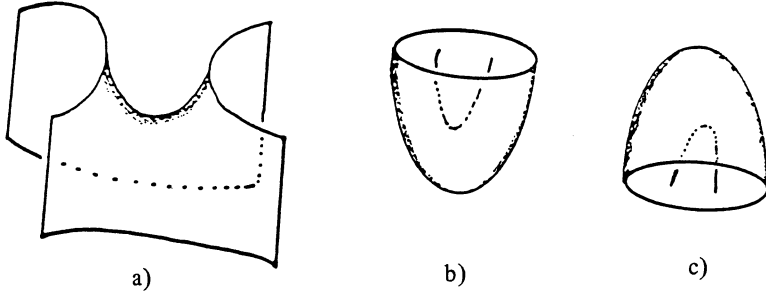

FIGURE 4.8

(2) The local behavior of \mathcal{L} near $N(k)$ is exactly as in Figure 4.1.

(3) If L is a leaf of \mathcal{L} , then L is transverse to the horizontal planes except at isolated saddles or at centers possessing neighborhoods which encapsulate local maxima or minima of k .

(4) If Q is a horizontal plane, then $Q \cap \mathcal{L}$ contains no circle C which bounds a disc in $Q - B$ unless there exists a center z whose encapsulating neighborhood contains C .

(5) If z is a center of \mathcal{L} and x is a critical point of k which a neighborhood of z encapsulates, then all tangencies of \mathcal{L} and \mathcal{H} between $h(z)$ and $h(x)$ correspond to critical points of discs (with respect to h) which encapsulate x .

Proposition 4.11. *If \mathcal{L} is a lamination carried by a branched surface in normal form in S^3 , then \mathcal{L} is isotopic to a lamination in normal form.*

Definition 4.12. Let \mathcal{L} be a finite depth lamination in M with a finite number of leaves. We define a new lamination \mathcal{W} obtained by thickening \mathcal{L} . Topologically each leaf L of \mathcal{L} is replaced by a closed interval of leaves each of which is isotopic to \mathcal{L} . Let \mathcal{W}_j be the lamination inductively obtained by thickening the depth $\leq j$ leaves. Let $\mathcal{W}_{-1} = \mathcal{L}$. Having defined \mathcal{W}_{i-1} let $N(L_i) = L_i \times I$ be a nice product neighborhood of the depth i leaves L_i . Let $f_i: M \rightarrow M$ be the map which contracts each I fiber of $N(L_i)$ to a point. \mathcal{W}_i is the lamination defined by $\mathcal{W}_i | N(L_i)$ equals the product foliation and $\mathcal{W}_i | (M - \dot{N}(L_i)) = f_i^*[\mathcal{W}_{i-1} | (M - L_i)]$.

Proposition 4.13. *Let \mathcal{L} be a finite depth lamination carried by the branched surface B . If \mathcal{W} is obtained by thickening \mathcal{L} , then \mathcal{W} is carried by B . In particular if B is in normal form, then \mathcal{W} is isotopic to a lamination in normal form.*

Definition 4.14. If B is a transversely oriented branched surface in an oriented 3-manifold P , then B defines the *sutured manifold* $S(B) = (M, \gamma)$ obtained from B by letting $M = P - \dot{N}(B)$, $\gamma = \partial_v N(B)$, and $R(\gamma) = \partial_h N(B)$.

The orientation on the interval foliation \mathcal{V} of $N(B)$ determines the transverse orientation on $R(\gamma)$.

Proposition 4.15. *If \mathcal{L} is a finite depth, finite leaved lamination fully carried by the branched surface B in the 3-manifold P , then the sutured manifold $(M, \gamma) = S(B)$ is naturally embedded in $P - \mathcal{W}$, where \mathcal{W} is the lamination obtained by thickening \mathcal{L} . Finally $J = P - \text{int.}(\mathcal{W} \cup M)$ has a natural product structure where the vertical interval fibration is $\mathcal{V} \upharpoonright J$. (Figure 4.9 shows a possible local picture of the 1-dimensional version.)*

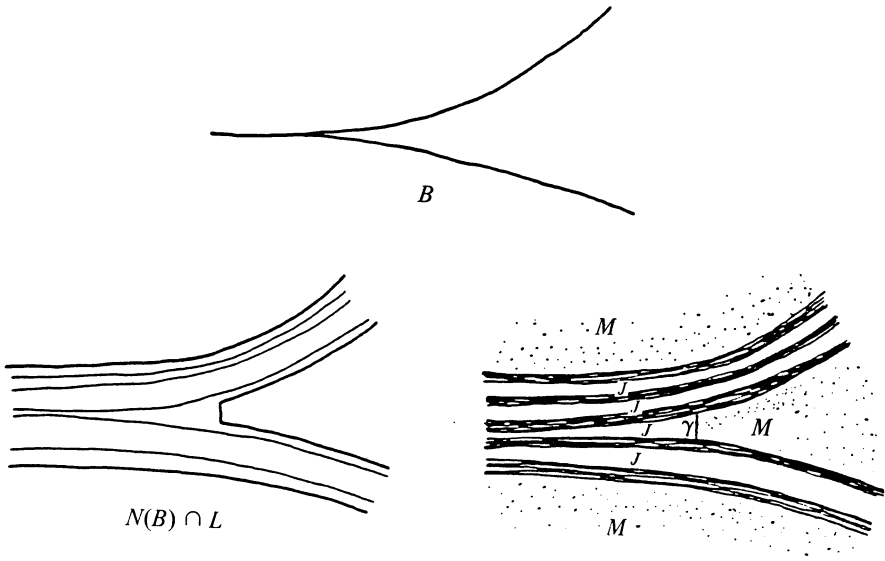

FIGURE 4.9

Construction 4.16. *Constructing branched surfaces from sutured manifold decomposition sequences.* Let

$$(N, \partial N) = (M_0, \gamma_0) \xrightarrow{S_1} (M_1, \gamma_1) \xrightarrow{S_2} \cdots \xrightarrow{S_n} (M_n, \gamma_n)$$

be a sequence of sutured manifold decompositions of the oriented irreducible 3-manifold N . Let $B_1 = S_1$. Suppose that the branched surfaces B_1, \dots, B_{r-1} have been constructed such that $S(B_i) = (M_i, \gamma_i)$. We show how to construct B_r so that $S(B_r) = (M_r, \gamma_r)$. B_r is obtained by attaching S_r to B_{r-1} and modifying the attaching map to obtain smooth switching with coherent transverse orientations. If the local picture of S_r and $R(\gamma_{r-1})$ appears as in Figure 4.10(a), then create B_r as in Figure 4.10(b). If the local picture of S_r and

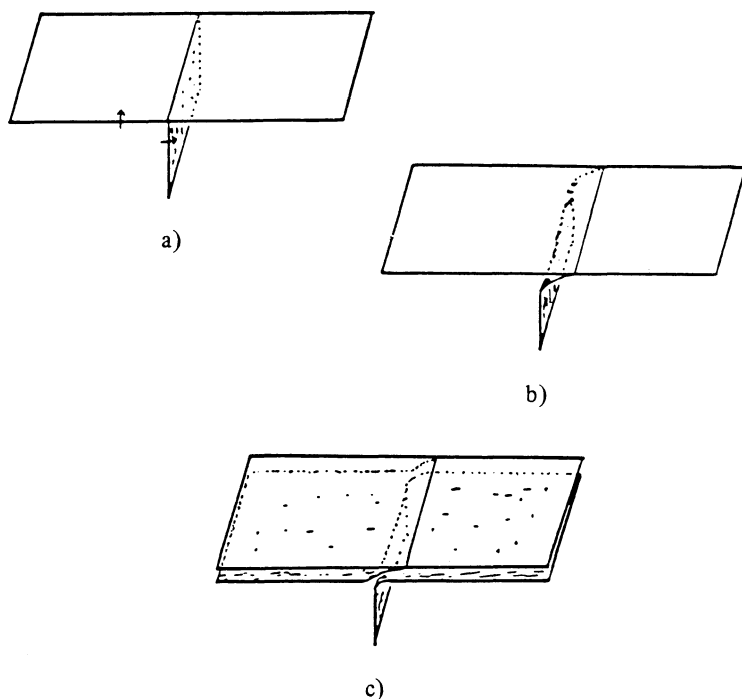

FIGURE 4.10

$R(\gamma_{r-1})$ appears as in Figure 4.11(a), then create B_r as in Figure 4.11(b). Note that Figure 4.11(b) is a union of Figures 4.11(b') and 4.11(b'') and the branch locus crosses as in Figure 4.6(c).

Construction 4.17. *Constructing finite depth laminations from sutured manifold decomposition sequences.* Let

$$(N, \partial N) = (M_0, \gamma_0) \xrightarrow{S_1} (M_1, \gamma_1) \xrightarrow{S_2} \dots \xrightarrow{S_n} (M_n, \gamma_n)$$

be a groomed sequence of sutured manifold decompositions of the oriented 3-manifold N . We give two equivalent, almost canonical, constructions of a finite depth lamination \mathcal{L}_n containing S_1 as a leaf which is fully carried by B_n , the branched surface arising from 4.16.

Description 1. First assume that the sutured manifold decomposition sequence is well groomed. Suppose that we have constructed a finite depth lamination \mathcal{X}_s on (M_s, γ_s) (let $\mathcal{X}_n = R(\gamma_n)$) with the property that \mathcal{X}_s is transverse to γ_s and $R(\gamma_s) \subset \mathcal{X}_s$. The construction of \mathcal{F}_0 in [3, pp. 471–477]

shows how to construct a finite depth foliation on (M_{s-1}, γ_{s-1}) having constructed one on (M_s, γ_s) . This construction works equally well in our setting to extend \mathcal{K}_s to a lamination \mathcal{K}_{s-1} on (M_{s-1}, γ_{s-1}) . \mathcal{K}_0 is the desired \mathcal{L}_n . In the case where the sequence is only groomed, by proceeding in a more refined way, as in the proof of Lemma 3.9, one constructs the desired \mathcal{L}_n .

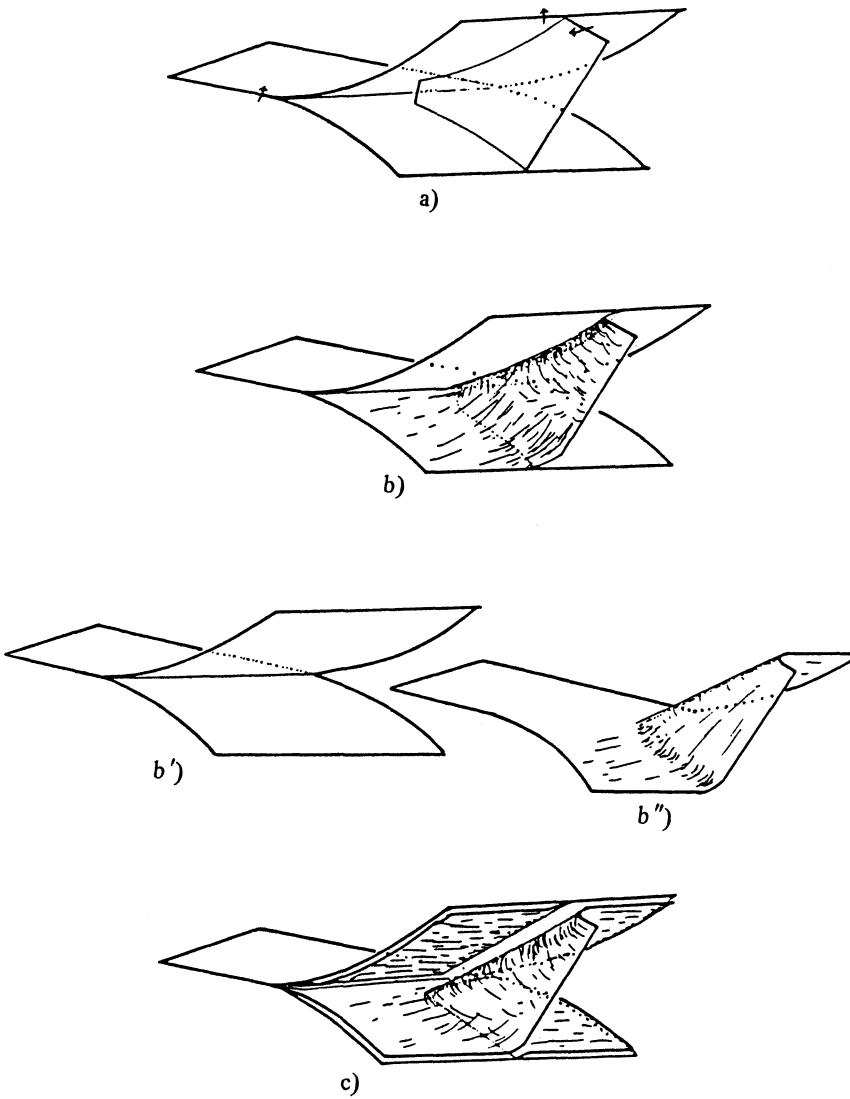

FIGURE 4.11

Description 2. Let $\mathcal{L}_1 = S_1$. Suppose that $\mathcal{L}_1, \dots, \mathcal{L}_{r-1}$ have already been constructed. Let \mathcal{W}_i be the lamination obtained by thickening \mathcal{L}_i . Let $C_i = N - \mathcal{W}_i$. View C_i as the noncompact (sutureless) sutured manifold (C_i, λ_i) where $\partial C_i = R(\lambda_i)$ inherits a transverse orientation from \mathcal{W}_i . In a natural way identify \dot{C}_i with $N - \mathcal{L}_i$. By Proposition 4.15 there exists a set A_i of product annuli in C_i such that decomposing (C_i, λ_i) along A_i yields (M_i, γ_i) and a (noncompact) product sutured manifold (B, β) .

View S_r as an embedded surface in $M_{r-1} \subset C_{r-1}$ where ∂S_r consists of properly embedded curves in $R(\gamma_{r-1})$, vertical arcs in A_{r-1} , and circles parallel to core curves in $A_{r-1} \cup E_{r-1}$ (see 3.2). Extend S_r to a properly embedded surface X_r in C_{r-1} as follows. To each circle component α of $\partial S_r \cap A_{r-1}$ attach an annulus Z with $\partial Z = \alpha \cup \alpha'$ where α' is a boundary parallel circle in $R_+(\beta)$. To each arc α component of $S_r \cap A_{r-1}$ let ω be a properly embedded arc in F (where $(B, \beta) = (F \times I, \partial F \times I)$) homeomorphic to $[0, 1)$. Extend S_r to $B \cup M_{r-1}$ by attaching $\omega \times I$ to α . Let R be the set of components of ∂C_{r-1} which intersect X_r nontrivially. Let $R \times I$ be a tiny product neighborhood of R where $R \times 0$ is identified with R . Let $\nabla = \{R \times 1, R \times \frac{1}{2}, R \times \frac{1}{4}, \dots\}$. Let U_r be the surface obtained by doing oriented cut and paste with X_r and ∇ . Our desired \mathcal{L}_r is the union of U_r and \mathcal{L}_{r-1} . \mathcal{L}_r is of finite depth and fully carried by B_r .

Remarks 4.18. (1) For simplicity we require that the sutured manifold sequence be groomed. If one drops the tautness hypothesis inherent in the definition of a groomed sequence one can still carry out the construction of 4.17. This same comment holds regarding Lemma 4.20.

(2) A sutured manifold decomposition sequence gives rise to a lamination which is well defined up to the paths ω chosen.

Proposition 4.19. *Let X_r be as in Description 2. If one changes X_r to X'_r using a sequence of the following operations, then X'_r will yield the same leaf L_r , hence the same \mathcal{L}_r as X_r .*

(a) *Let W be a compact subsurface of $R(\lambda_r)$ (i.e., W inherits orientation from $R(\lambda_r)$) isotoped slightly to be properly embedded in $C_r - \dot{E}_r$. Let X'_r be the surface obtained by cutting and pasting X_r and W .*

(a') *If W is a component of X_r which is boundary parallel to a compact subsurface of $R(\lambda_r)$, or W is of the form $\omega \times I$ where ω is a properly embedded inessential arc or circle, then let $X'_r = X_r - W$.*

(b) *Surger X_r along a square S as described in Figure 4.12. Note that S must intersect X_r on the "same side."*

Consider the sutured manifold sequence of Description 2. Let R be a component of $R(\gamma_{r-1})$ such that $R \cap S_r \neq \emptyset$. Let R' be the surface obtained

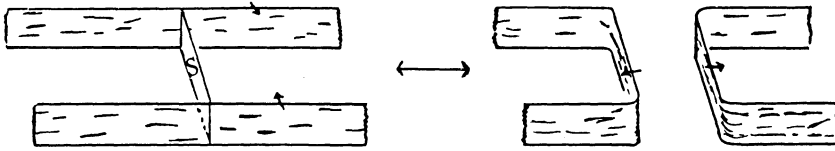

FIGURE 4.12

by cutting and pasting R and S_r . Isotope R' slightly so that $R' \cap R(\gamma_{r-1}) = S_r \cap R(\gamma_{r-1})$ and $R' \cap \gamma_{r-1}$ is a union of essential curves. Let (M', γ') be the sutured manifold obtained by decomposing (M_{r-1}, γ_{r-1}) along S' . Observe (compare [6, Lemma 0.6]) that by decomposing (M', γ') along a set H of product annuli or discs one obtains (M_{r-1}, γ_{r-1}) plus a product sutured manifold (Z, ξ) . There is a one-to-one correspondence between components of H and components of $S' \cap R$. Finally (M', γ') naturally embeds in the sutured manifold (C_r, λ_r) and $\mathcal{L}' = \mathcal{L}_r$, where \mathcal{L}' is the lamination obtained by changing the original sutured manifold sequence by replacing S_r by R' . These observations lead to the following:

Lemma 4.20. *Let*

$$(N, \partial N) = (M_0, \gamma_0) \xrightarrow{S_1} (M_1, \gamma_1) \xrightarrow{S_2} \dots \xrightarrow{S_n} (M_n, \gamma_n)$$

be a groomed sequence of sutured manifold decompositions. Let R be a finite number of pairwise disjoint properly embedded surfaces in M_j such that each component nontrivially intersects S_j and lies parallel to and very close to a component of $R(\gamma_{j-1})$. Let T_j be the surface obtained by doing oriented cut and paste to S_j and R . Then there exists a groomed sequence

$$(N, \partial N) = (N_0, \delta_0) \xrightarrow{T_1} (N_1, \delta_1) \xrightarrow{T_2} \dots \xrightarrow{T_n} (N_n, \delta_n)$$

which has the following properties:

- (1) *If $i < j$, then $T_i = S_i$ and $(M_i, \gamma_i) = (N_i, \delta_i)$.*
- (2) *T_j is defined as above.*
- (3) *There exists a lamination \mathcal{L}' determined by the (N, δ) sequence which equals a lamination \mathcal{L} determined by the (M, γ) sequence.*
- (4) *If $i > j$, then there exists a set A of product annuli in (N_i, δ_i) such that decomposing (N_i, δ_i) along A yields a disjoint union of (M_i, γ_i) and a product sutured manifold.*

Proof. We will construct the lamination \mathcal{L} for the (M, γ) sequence as in Description 2 of 4.17. Let $A_i, (C_i, \lambda_i)$, etc. be as defined there. The key to the lemma is to choose the paths ω to construct \mathcal{L} correctly.

Suppose that $(N_0, \delta_0), \dots, (N_r, \delta_r)$ and T_1, \dots, T_r have been constructed for some $r \geq j$ so that the (N, δ) sequence satisfies the conclusions of the lemma and satisfies $(M_r, \gamma_r) \subset (N_r, \delta_r) \subset (C_r, \lambda_r)$. Suppose, also, that there exists a set A'_r of product annuli in C_r such that decomposing (C_r, λ_r) along A'_r yields (N_r, δ_r) and a product sutured manifold.

First, extend S_{r+1} to X_{r+1} in C_r as in Description 2 using paths ω which have the property that $|\omega \cap A'_r| = 1$. Second, surger X_{r+1} using operation (b) of 4.19 near A'_r so that $|A'_r \cap X_{r+1}| = \langle R_-(\lambda_r) \cap A'_r, R_-(\lambda_r) \cap X_{r+1} \rangle$. As in the proof of Lemma 0.6 of [6] we can find a set $\{W_1, \dots, W_p\}$ of compact subsurfaces of $R(\delta_r)$ such that after applying operation (a) to these compact subsurfaces and operation (a') to the result, one obtains a new X_{r+1} such that $X_{r+1} \cap N_r = T_{r+1}$ is a groomed surface in (N_r, δ_r) . By construction the induction hypotheses hold for (M_{r+1}, γ_{r+1}) and (N_{r+1}, δ_{r+1}) . By Proposition 4.19, \mathcal{L}'_r equals the lamination \mathcal{L}'_r defined by the (M, γ) sequence. The result follows by induction.

(C) Putting laminations into normal form.

Lemma 4.21. *Let k be a knot in a thin presentation in S^3 . If*

$$(S^3 - \mathring{N}(K), \partial N(k)) = (M_0, \gamma_0) \xrightarrow{S_1} (M_1, \gamma_1) \xrightarrow{S_2} \dots \xrightarrow{S_n} (M_n, \gamma_n)$$

is a groomed sequence of sutured manifold decompositions such that $S_i \cap E_{i-1}$ is a union of simple closed curves, then the lamination \mathcal{L} determined by this sequence can be put into normal form. Furthermore there exists a new sutured manifold sequence

$$(S^3 - \mathring{N}(k), \partial N(k)) = (N_0, \delta_0) \xrightarrow{T_1} (N_1, \delta_1) \xrightarrow{T_2} \dots \xrightarrow{T_n} (N_n, \delta_n)$$

having the same properties as the (M, γ) sequence plus the following:

- (1) *The lamination \mathcal{L}' determined by the (N, δ) sequence equals \mathcal{L} .*
- (2) *By decomposing (N_n, δ_n) along product annuli and discs one can obtain a disjoint union of (M_n, γ_n) and a product sutured manifold.*
- (3) *The associated sequence of branched surfaces B_1, \dots, B_n are in normal form in S^3 and \mathcal{L} is carried by B_n .*

Idea of Proof. Put the lamination into normal form one leaf at a time. Having put the first r leaves in normal form we then insert the next leaf so that, away from a compact region, it lies very close to the previous leaves. A compactly supported isotopy puts this leaf in normal form.

Step 1. Isotope S_1 into normal form.

The fact that we can put the compact surface S_1 in normal form basically follows from the isotopy result of Rousserie [18] and Thurston [20]. We present the proof here since the proof that the general leaf can be put in normal form is only a slight modification.

Isotope S_1 so that it has the correct normal form near k and that it is smoothly embedded and transverse to the height function except at isolated saddles, centers in normal form and *plateaus*. A plateau is an embedded (planar) surface $P \subset S$ such that h is constant on P and h is locally either maximized or minimized at P . Recall that saddles and centers are isolated points of tangency of S with \mathcal{H} .

As in [18] if P is a plateau or center, then there exists a neighborhood U of P in S whose induced foliation $\mathcal{H}|_U$ is one of the types given in Figure 4.13

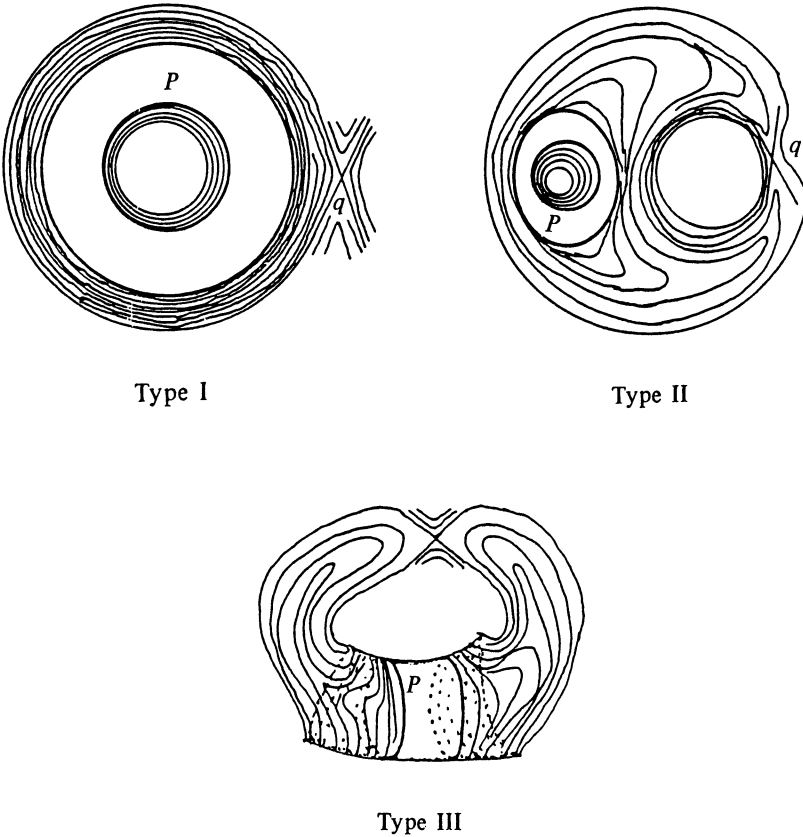

FIGURE 4.13

(see Figure 7.1 of [3] for the corresponding picture when P is a center). More precisely there exists a maximal closed neighborhood $U' \subset U$ of P such that $\mathcal{H}|_{U' - \dot{P}}$ is a foliation by $|\partial P|$ families of “circles” indexed by $[0, 1]$. The initial circle α_0 corresponds to ∂P . The circles α_t , indexed by $t < 1$ consist of $|\partial P|$ horizontal circles in S^3 . The limit “curve” α_1 nontrivially intersects a saddle tangency q and is smooth away from q . In particular it consists of either $|\partial P| - 1$ or $|\partial P| - 2$ smooth horizontal circles. If all but one circle is smooth, then α_1 is smooth except for either a single corner at q (i.e., P is *type I*) or two corners at q (i.e., P is *type II*). If α_1 has $|\partial P| - 2$ smooth circles, (i.e., P is *type III*) then two components of ∂P are squeezed together. Figure 4.14 shows what U looks like in S^3 , when P is of type III. In any case each α_t , $t < 1$, bounds an embedded horizontal planar surface P_t in S^3 so there exists a map $F: P \times I \rightarrow S^3$ such that $F(\partial P_t \times I) = \alpha_t$, $F(P \times 0) = P$, $F|_{P \times [0, 1)}$ is an embedding, and $F(P \times 1)$ is obtained by pinching a point on ∂P , or squeezing P along a properly embedded interval, or identifying two points of ∂P .

Definition 4.22. If x is a point of tangency of \mathcal{H} with a transversely oriented surface S , then define $\sigma(x) = 1$ (resp. -1) if the normal vector to S points up (resp. down).

If P is of type I (resp. type II), then we say P is of *type Ia* (resp. *type IIa*) if $\sigma(P) = \sigma(q)$, otherwise we say that P is of *type Ib* (resp. *type IIb*). When $P = D^2$, a neighborhood of a type Ia (resp. Ib) plateau embedded in S^3 looks, after flattening out the hilltop, exactly like the left-hand side (resp. right-hand side modified to be embedded) of [3, Figure 7.7] $F(D^2 \times 1)$ appears as in [3, Figure 7.6(a) (resp. Figure 7.6(b))]. A neighborhood of a type IIa (resp. IIb) plateau, when $P = D^2$, looks, after flattening out the hilltop, exactly like [3, Figure 7.10 (resp. Figure 7.11)] with $F(D^2 \times 1)$ appearing as in [3, Figure 7.6(c) (resp. 7.6(d))].

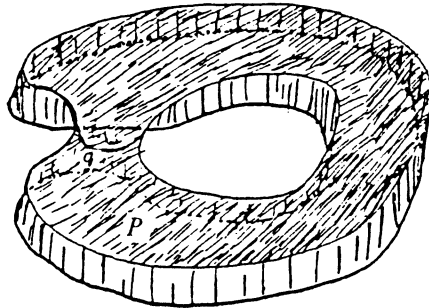

FIGURE 4.14

To see that these are the exact pictures draw a picture of $S \cap N(Q_\alpha)$ where $\alpha = h(q)$ as in Figure 4.15. $S \cap N(Q_\alpha)$ looks like a union of vertical annuli and a single saddle. Now view P as lying in $Q_{\alpha+\epsilon}$. The above paragraphs enumerate the possibilities.

We now prove Step 1 by induction on the complexity $c(S) = (3|\text{plateaus}| + 2|\text{centers}|)$.

After possibly turning \mathbb{R}^3 upside down (i.e., replacing $h(x)$ by $-h(x)$) we can find a plateau P with the following properties. P is a maximum and either P is the lowest plateau in \mathbb{R}^3 or P is the lowest plateau in $P \subset F(P' \times (0, 1))$ for some plateau P' which is a local minimum.

If each plateau is a local maximum let P be the lowest one. Otherwise let P' be the highest plateau which is a local minimum. If $F(P' \times (0, 1))$ contains a plateau let P be the lowest one. If $F(P' \times (0, 1))$ contains no plateaus, then turn \mathbb{R}^3 upside down and let $P = P'$.

Case 1. $k \cap F(P \times I) \neq \emptyset$.

Proof. There exists a smallest t such that $F(P[0, t] \cap k) \neq \emptyset$. Each component D of $F(P[0, t]) \cap S$ is a disc which contains a center in normal form. A maximal point x of D is either a center or is contained in a plateau. If x is a center, then by assumption it is a center in normal form and D is a disc. By the way P was chosen, x could not have been contained in a plateau.

Isotope $P \cup F(\partial P \times [0, t + \epsilon])$ rel ∂ to create a center in normal form and $1 - \chi(P)$ saddles. To see this operation for the case when P is an annulus, start with the flattened rim of a volcano with a local maximum of k lying just under the rim. Push down on the other side of the rim to create a type IIa center [3, Figure 7.10]. This operation eliminates a plateau and creates a center, hence the complexity is reduced. q.e.d.

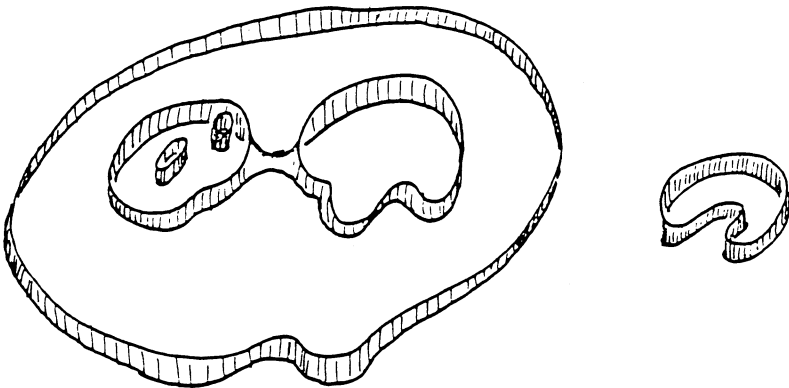

FIGURE 4.15

We will now assume that $k \cap F(P \times I) = \emptyset$.

Case 2. P is of type III.

Proof. The incompressibility of S implies that this cannot occur.

Case 3. P is of type Ia.

Proof. If P is a disc, then isotope S as in [3, Figures 7.7 and 7.8] to cancel the plateau with a saddle. More generally isotope S to $S' = (S - F(P \times I)) \cup F(P \times 1)$ and then isotope it a bit more as in Case 1 to eliminate the plateau and create $1 - \chi(P)$ saddles.

Case 4. P is of type Ib.

Proof. Necessarily $F(P \times (0, 1)) \cap S \neq \emptyset$, but this contradicts the choice of P .

Case 5. P is of type IIb.

Proof. We analyze the case $P = D^2$ since the others are similar. S locally appears as in [3, Figure 7.11] (imagine the hilltop flattened out). The incompressibility of S implies that one of λ_1 or λ_2 (say λ_2) bounds a disc D in S which does not contain the other. The irreducibility of S^3 implies that we can perform an isotopy of S which is the identity away from a neighborhood of D to obtain (before smoothing the corners) $S' = (S - D) \cup D'$, where D' is the disc which λ_1 bounds in $F(P \times 1)$. Since D must contain at least one plateau or center we have reduced the complexity of S .

Case 6. P is of type IIa.

Proof. Isotope S to $S' = (S - F(P \times I)) \cup F(P \times 1)$ and then a bit further to create a surface S'' which has a plateau P_1 with $\chi(P_1) = \chi(P) - 1$. If one of the previous cases applies to P_1 , then we are done, otherwise we isotope P_1 further to obtain a plateau P_2 with $\chi(P_2) = \chi(P) - 2$. Continue in this manner to eventually either cancel out this plateau or obtain a plateau P_r such that some component λ of ∂P_r bounds a disc F in the level plane Q which contains P such that $\dot{F} \cap S = \emptyset$. The incompressibility of S implies that λ bounds a disc D in S . By performing an isotopy of S which is the identity away from a neighborhood of D we reduce the complexity of S . q.e.d.

After finitely many applications of Cases 1–6 we eliminate all plateaus.

Case 7. There exist a level plane Q and a component C of $Q \cap S$ which bounds a disc D in $Q - S$ and a disc F in S such that F does not contain a unique center.

Proof. S is isotopic to $S' = (S - F) \cup D$. Since we have eliminated at least 2 centers and have created exactly one plateau, $c(S') < c(S)$.

Remarks 4.23. The isotopy of Step 1 could have been carried out in such a way that plateaus were not smoothed out until the very end. For example, if

Case 1 is applicable, then instead of creating a center and $1 - \chi(P)$ saddles, simply leave P as a plateau but count it as a center. If Case 3 is applicable, then instead of smoothly cancelling the saddle and plateau, leave the plateau as a flat surface at the level of the old saddle. Only at the very end should the surface be smoothed out. The utility of this approach is that if S' is the surface obtained by partially isotoping S as above, then $S' - (\text{flat part of } S') \subset S$.

Step 2.

Lemma 4.24. *Let k be a knot in thin position in S^3 . Let B be a branched surface in normal form in $S^3 - \mathring{N}(k)$ such that $S(B) = (M, \gamma)$ is taut. Suppose that $(M, \gamma) \xrightarrow{S} (M', \gamma')$ is a groomed sutured manifold decomposition. Let R be the components of $R(\gamma)$ which nontrivially intersect S . Let S_r , $r \geq 0$, be the properly embedded surface in M obtained by doing oriented cut and paste with r boundary parallel copies of R and let $(M, \gamma) \xrightarrow{S_r} (M_r, \gamma_r)$ be the associated sutured manifold decompositions with complementary branched surfaces B_r .*

There exists an r such that B_r is isotopic rel B to a branched surface in normal form.

Proof. Isotope S so that ∂S is disjoint from neighborhoods of saddles, critical points of the branch locus, and discs which encapsulate critical points of k . Furthermore the height function restricted to ∂S should describe a Morse function. Isotope S so that it is transverse to \mathcal{H} except at isolated saddles and plateaus which are distinct from the critical levels of B and k . Construct the branched surfaces B_0, B_1, B_2, \dots using the construction of 4.16. In a natural way if $i < j$, then $S_i \subset S_j \subset B_j$. After a preliminary isotopy of B_j rel B supported in a neighborhood of the branched locus of B we can assume that each B_j satisfies condition (6) of Definition 4.9. B_j should be constructed so that each tangent plane of $B_j - S$ lies very close and parallel to a tangent plane of B . For example if Figure 4.10(b) (resp. 4.11(b)) shows a local picture of B_0 , then Figure 4.10(c) (resp. 4.11(c)) shows the local picture of B_1 .

Let $m = \max\{|Q_\alpha \cap S| \mid \alpha \in \mathbb{R}\}$. If Q is a level plane, $s > m$, and $Q \cap B_s$ contains a smooth circle C which bounds a disc in $Q - B$, then either $C \subset S_m$, or C bounds a smooth disc $F \subset B_s$ such that $F \cap S = \emptyset$ and F encapsulates in normal form a critical point of k . To see this let $C \subset Q \cap B_s$ be a smooth circle which bounds a disc F in $Q - B$. F contains discs $F_1 \subset \dots \subset F_s = F$ with pairwise disjoint boundaries such that $\partial F_i \subset B_s$. If $F \cap S \neq \emptyset$, then $F_i \cap S \neq \emptyset$ for each i , so $|F \cap B_s| < |Q \cap S| \leq m$. Therefore $C \subset S_m$ or $C \cap S = \emptyset$. The result follows (compare Figure 4.16).

Let $r = m + m'$ where m' is the number of plateaus and centers in normal form of S_m . Let $\Omega = \{\text{centers and plateaus of } B_r \text{ which are contained in } S_m\}$. Define $c(\Omega) = (3|\text{plateaus}| + 2|\text{centers}|)$.

Now isotope B_r by an isotopy performed exactly as in Step 1. The key point is that the isotopy will only involve modifications of Ω (i.e., the centers of $B_r - \Omega$ are untouched). Therefore the program of Step 1 can be completed by doing at most $|\Omega|$ sequences of pushing down on plateaus. Each push can involve at most one new S_i where $i > m$. Choose a plateau $P \subset \Omega$ as in Step 1. We indicate the modifications of Ω which are involved in the cases of Step 1.

Case 1. Here a plateau is transformed into a center.

Case 2. Does not occur.

Case 3. Here a plateau is deleted from Ω .

Case 4. Does not occur.

Case 5. Here all the plateaus and centers of S_r contained in a disc D are deleted. By Remark 4.23 and the choice of m , $\partial D \subset S_m$; hence $D \subset S_m$, so all these plateaus and centers are contained in Ω . In particular $c(\Omega)$ has been reduced.

Case 6. Here one of the modifications of the previous cases occurs.

Case 7. A plateau is created and at least two centers of Ω are deleted. That all centers deleted actually belong to Ω follows as in Case 5.

Step 3. Proof of Lemma 4.21.

Proof. We will construct the tower of Figure 4.17. The (N, δ) sequence is obtained by letting $T_i = S_i$ and $(N_i, \delta_i) = (M_i, \gamma_i)$. Apply Step 1 to put S_1 in normal form. Let S_2 be the surface S_r obtained by applying Lemma 4.24 where $(M_1, \gamma_1) \xrightarrow{S_2} (M_2, \gamma_2)$ equals $(M, \gamma) \xrightarrow{S} (M', \gamma')$. Now apply Lemma 4.20 to the

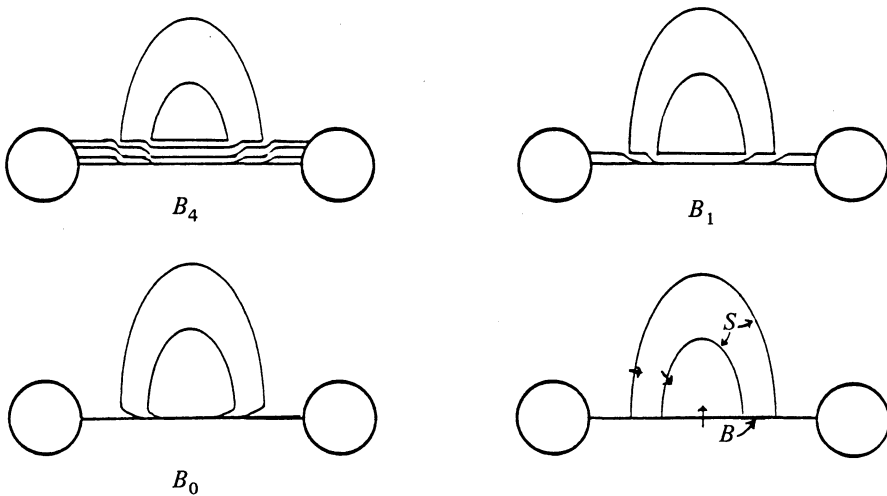

FIGURE 4.16

sequence of sutured manifold decompositions on the bottom row of Figure 4.17 to obtain the sequence on the second row of Figure 4.17. In a similar manner having constructed the j th row of Figure 4.17 one obtains S_{j+1} by applying Lemma 4.24 and one obtains the $(j + 1)$ st row by invoking Lemma 4.20. The conclusions of Lemmas 4.20 and 4.24 imply that the (N, δ) sequence satisfies the conclusions of Lemma 4.21.

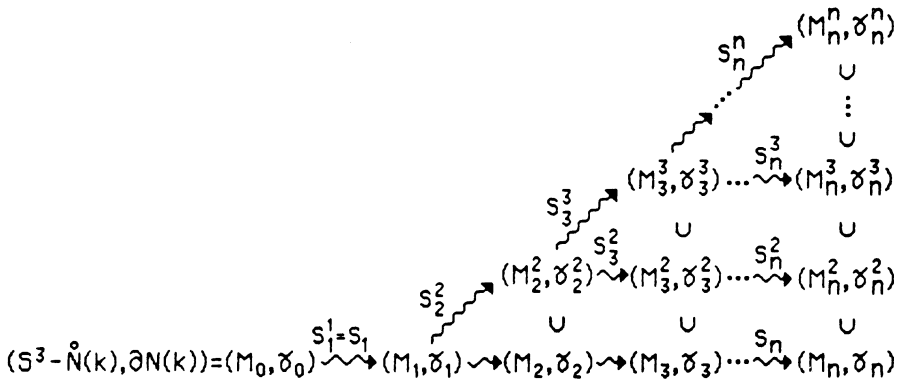

FIGURE 4.17

(D) Finding an essential 2-sphere in S^3 .

Let M be a compact oriented 3-manifold whose boundary is a union of tori. A lamination $\mathcal{W} \subset M$ has *geometrically incompressible* leaves if for every disc D such that $\partial D \subset \mathcal{W}$ and $D \cap \mathcal{W} = \emptyset$, ∂D bounds a disc in a leaf of \mathcal{W} . It is easy to see that laminations arising from groomed sutured manifold sequences are geometrically incompressible. In fact the leaves of \mathcal{W} inject into M in π_1 . To see this use [3] to extend \mathcal{W} to a taut foliation \mathcal{F} on M and then apply Novikov’s theorem.

We are now ready to find an essential 2-sphere Q in S^3 . The following result is a generalization of Lemma 4.4.

Lemma 4.25. *Let k be a nontrivial knot in S^3 . Let \mathcal{L} be a finite depth lamination with incompressible leaves in $S^3 - \dot{N}(k)$ in normal form. Let \mathcal{W} be the lamination obtained by thickening \mathcal{L} . If (M, γ) is a sutured manifold embedded in $S^3 - \dot{\mathcal{W}}$ such that $R(\gamma) \subset \partial \mathcal{W}$ and γ is a union of properly embedded incompressible annuli in $(S^3 - \dot{N}(k)) - \dot{\mathcal{W}}$ and a nonempty set E of boundary sutures, then one can isotope (M, γ) and \mathcal{W} and find a 2-sphere Q such that*

- (0) $Q \cap k \neq \emptyset$ and Q is transverse to M .
- (1) Q is transverse to \mathcal{W} except possibly at a finite number of saddles in $\dot{\mathcal{W}}$,
- (2) at most one component of $\partial \mathcal{W} \cap Q$ is a circle bounding a disc in $Q - \dot{\mathcal{W}}$,
- (3) each circle component of $Q \cap \gamma$ is homotopically nontrivial in $Q - \dot{\mathcal{W}}$,

- (4) each arc component of $Q \cap \gamma$ is an essential arc in γ , and
- (5) each arc component of $Q \cap (\partial M - \dot{E})$ is an essential arc in $\partial M - \dot{E}$.

Proof. Isotope M slightly so that ∂M is transverse to \mathcal{H} except at a finite number of center and saddle tangencies, and $\partial\gamma$ is transverse to \mathcal{H} except at a finite number of critical points. Assume that all such tangencies are at distinct levels and the tangencies of $\partial\gamma$ and γ with \mathcal{H} are at levels distinct from the tangencies of leaves of \mathcal{W} and \mathcal{H} . Since $S = \partial M - \dot{E}$ is in standard form near k we can apply the proof of Lemma 4.4 to find a level plane Q lying between the height h of the highest local minimum of k and the height of the lowest local maximum of k which is greater than h , such that each arc of $Q \cap S$ is essential in S . By construction conclusion (0) holds. By raising Q slightly if necessary we can assume that Q is transverse to \mathcal{L} . By extending Q to ∞ we can view Q as a 2-sphere.

Since \mathcal{L} is in normal form and \mathcal{W} is obtained by thickening \mathcal{L} a tiny bit it follows that (1), (2), and (3) hold for \mathcal{W} and Q . By construction each arc of $Q \cap (\partial M - \dot{E})$ is essential in $\partial M - \dot{E}$, so (5) holds. If some circle component β of $\gamma \cap Q$ bounds a disc D in $Q - \mathcal{W}$, then $R(\gamma) \subset \mathcal{W}$ implies that $D \cap \partial M = D \cap \gamma$. Therefore by choosing an innermost component in D of $D \cap \gamma$ we can assume that either $D \subset S^3 - \text{int.}(\mathcal{W} \cup M)$ or $D \subset M$. The incompressibility of γ in $(S^3 - \dot{N}(k)) - \mathcal{W}$ implies that β bounds a disc in γ . Use the irreducibility of S^3 to isotope M to remove this and possibly other components of $Q \cap \partial M$ from ∂M and Q . Note that if $\dot{D} \cap M = \emptyset$ then this isotopy has the effect of attaching a disc to $Q \cap M$. By continuing in this manner, we can assume that all but possibly (4) of the conclusions of Lemma 4.25 hold. Assume that $|Q \cap k|$ is minimal among all 2-spheres Q which satisfy all but possibly (4). For such a Q each circle component of $\gamma \cap Q$ is essential in γ .

To prove (4) we will first show that each arc component of $Q \cap \gamma$ is essential in $Q - \mathcal{W}$. Suppose that there exists a component β of $Q \cap \gamma$ and a disc $D \subset Q$ such that $\partial D \subset \beta \cup \mathcal{W}$ and $\dot{D} \cap (\mathcal{W} \cup \gamma) = \emptyset$. Since both endpoints of β lie (say) in $R_+(\gamma)$, β is an inessential arc in γ . Let $B \subset \gamma$ be the associated boundary compressing disc. The incompressibility of the leaves of \mathcal{W} implies that there exists a 2-sphere $S = B \cup C \cup D$ (where C is a 2-disc contained in a leaf of \mathcal{W}). An isotopy of M supported in a neighborhood of the 3-cell which S bounds reduces the number of arc components of $Q \cap \gamma$. We now assume that every component of $Q \cap \gamma$ is essential in $Q - \mathcal{W}$.

Let β be an inessential arc of $Q \cap \gamma$ whose corresponding boundary compressing disc $B \subset \gamma$ (Figure 4.18(c)) contains no other inessential arcs. Isotope \mathcal{W} and M as in Figures 4.18(e),(f) to remove this arc of intersection of $Q \cap \gamma$. Figure 4.18(g) shows three leaves of the isotoped \mathcal{W} . This isotopy is

supported on a neighborhood of B and can be physically achieved by pushing B through the other side of Q . Figure 4.18(a) shows the intersection of \mathscr{W} with a neighborhood of the component Y of $Q \cap ((S^3 - \dot{N}(k)) - \mathscr{W})$ which contains β . Figure 4.18(b) shows the intersection on $N(Y)$ with the isotoped \mathscr{W} . Figures 4.18(c), (d) show the effect of the isotopy on $Q \cap \partial M$.

Remarks 4.26. If one restricts oneself to level 2-spheres, then Q can be chosen so that the conclusions of Lemma 4.25 hold if (1) is modified as follows. Q is transverse to \mathscr{W} except possibly at a finite number of saddles and centers in \mathscr{W} . To each center c there exists an annulus $A \subset Q \cap \mathscr{W}$ such that $c \in A$ and the components of ∂A are contained in leaves of \mathscr{W} .

Lemma 4.27. *Let*

$$(S^3 - \dot{N}(k), \partial N(k)) \xrightarrow{S_1} (M_1, \gamma_1) \xrightarrow{S_2} \cdots \xrightarrow{S_n} (M_n, \gamma_n) = (M, \gamma)$$

be a groomed sequence of sutured manifold decompositions such that each $S_i \cap \partial(N(k))$ is a union of simple closed curves. Let $E \subset \gamma$ denote the set of boundary sutures. Then there exists a 2-sphere Q such that $Q \cap k \neq \emptyset$, Q is transverse to M , each arc component of $Q \cap \gamma$ (resp. $Q \cap (\partial M - \dot{E})$) is essential in γ (resp. $\partial M - \dot{E}$). Further, $Q \cap M = \{q_i, \dots, q_r\} \cup D$ where each q_i is a connected surface and either $D = \emptyset$ or D is a disc and $D \cap \partial \gamma = \emptyset$ and

$$\sum_{i=1}^r \frac{|\partial q_i \cap \partial \gamma|}{4} - \chi(q_i) \leq |Q \cap k| - 1.$$

Finally, each q_i contributes a nonnegative number to the above summation.

Proof. By 4.17 the sequence

$$(S^3 - \dot{N}(k), \partial N(k)) \xrightarrow{S_1} (M_1, \gamma_1) \xrightarrow{S_2} \cdots \xrightarrow{S_n} (M_n, \gamma_n) = (M, \gamma)$$

determines a finite depth lamination \mathscr{L} which has incompressible leaves since each (M_i, γ_i) is taut. By Lemma 4.21, \mathscr{L} is carried by a branched surface in normal form, so \mathscr{L} itself can be isotoped to be in normal form in S^3 . By Description 2 of 4.17 each component of $\gamma - E$ is a properly embedded annulus in $(S^3 - \dot{N}(k)) - \mathscr{W}$ and $R(\gamma) \subset \mathscr{W}$. To see that each component of $\gamma - E$ is incompressible in $(S^3 - \dot{N}(k)) - \mathscr{W}$ observe that M is connected, taut, and not of the form $(D^2 \times I, (\partial D^2) \times I)$ if $\gamma - E \neq \emptyset$, and that each component of $(S^3 - \dot{N}(k)) - \text{int.}(\mathscr{W} \cup M)$ is a noncompact product ‘‘sutured manifold.’’ We conclude that (M, γ) and \mathscr{L} satisfy the hypothesis of Lemma 4.25.

Let Q be the 2-sphere obtained from Lemma 4.25. Construct a vectorfield \mathbf{X} on $Q - \dot{N}(k)$ as follows. Since \mathscr{W} is transversely oriented we can define \mathbf{X} on $Q \cap \mathscr{W}$ so that \mathbf{X} is tangent to the leaves of $\mathscr{W}|_Q$ and is singular only at the points of tangency of Q and \mathscr{W} . Therefore $\mathbf{X}|_Q \cap \mathscr{W}$ is nonsingular away

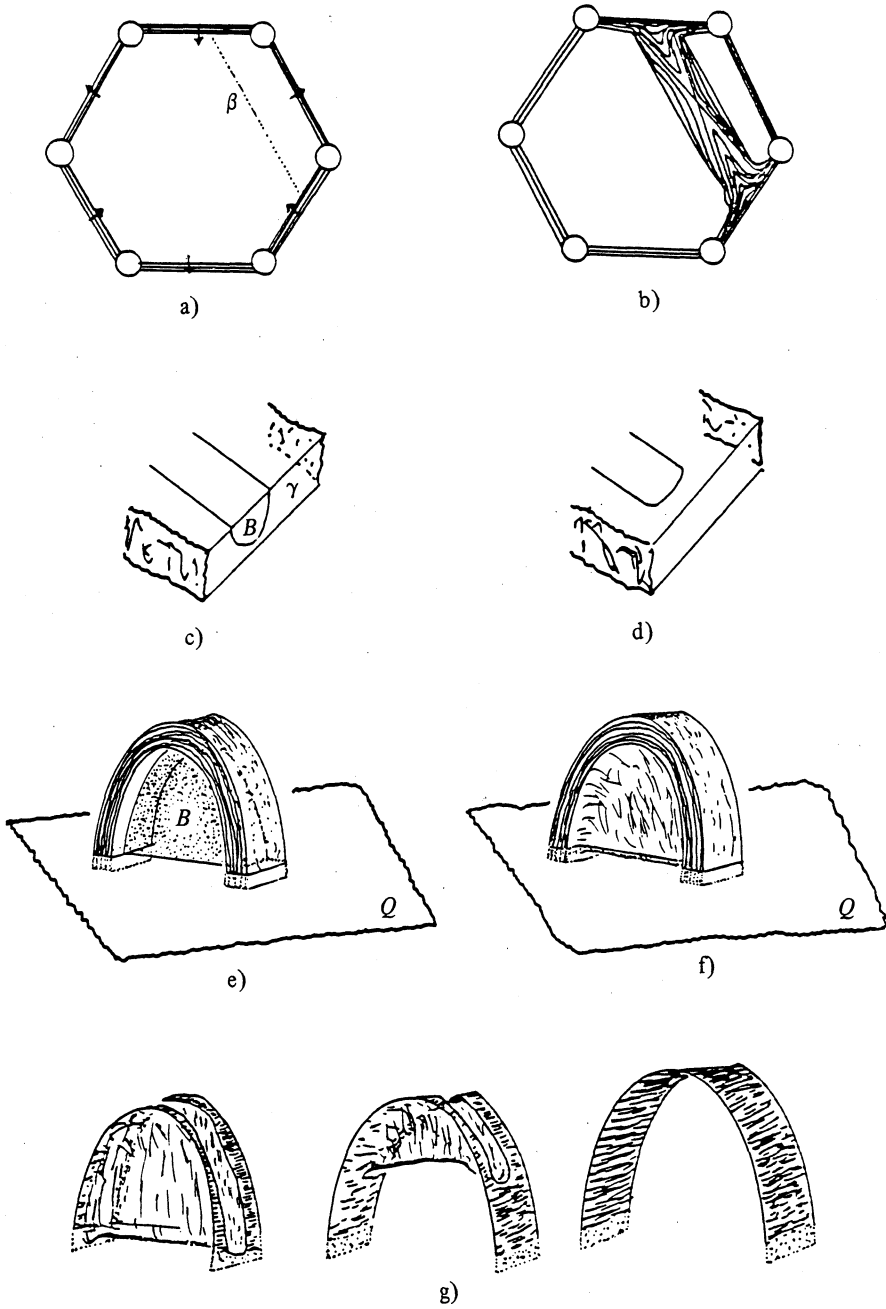

FIGURE 4.18

from a finite number of singularities of negative index. Extend \mathbf{X} to each component of $Q \cap M$ and each component of $Q - \text{int}(\mathscr{W} \cup M)$ so that \mathbf{X} is tangent to \mathscr{W} , \mathbf{X} is transverse to γ , and \mathbf{X} is nonsingular except at a finite number of points. By (2) of Lemma 4.25, at most one component of $Q - \mathscr{W}$ is a disc D with smooth boundary, so \mathbf{X} could have been chosen to be nonsingular except at a finite number of singularities of negative index plus at most one point where it has a singularity of index + 1. The lemma now follows from the following inequalities which rely on the Poincaré-Hopf index formula.

$$\begin{aligned} \sum_{i=1}^r \chi(q_i) - \frac{|\partial q_i \cap \partial \gamma|}{4} &= \text{index}(\mathbf{X}|(M \cap Q) - D) \\ &\geq \text{index}(\mathbf{X}|((Q - \dot{N}(k)) - D)) = \text{index } \mathbf{X} - \text{index } \mathbf{X}|D \\ &= \chi(Q - \dot{N}(k)) - \chi(D) \geq 2 - |Q \cap k| - 1 = 1 - |Q \cap k|. \end{aligned}$$

(E) A useful generalization.

Lemma 4.28. *Let M be a compact oriented 3-manifold whose boundary is a (possibly empty) union of tori. Let k be a knot in M such that $M - k$ is irreducible and let Q be a surface in M such that $Q - \dot{N}(k)$ is incompressible in $M - \dot{N}(k)$. Let*

$$(M - \dot{N}(k), \partial N(k)) \xrightarrow{S_1} (M_1, \gamma_1) \xrightarrow{S_2} \cdots \xrightarrow{S_n} (M_n, \gamma_n)$$

be a groomed sequence of sutured manifold decompositions such that each $S_i \cap \partial N(k)$ is a union of circles parallel to λ , a simple closed curve not parallel in $\partial N(k)$ to $Q \cap \partial N(k)$. Then one can isotope (M_n, γ_n) so that Q is transverse to M_n , each component of $Q \cap \gamma_n$ is essential in γ_n , $Q \cap M = \{q_i, \dots, q_m\}$, and

$$\sum_{i=1}^r \frac{|\partial q_i \cap \partial \gamma|}{4} - \chi(q_i) \leq |Q \cap k| - \chi(Q).$$

Finally, each q_i is a connected surface and contributes a nonnegative number to the above summation.

Proof. Use [3, §3] to extend the given sutured manifold sequence to a groomed sutured manifold hierarchy. Let \mathscr{F} be the finite depth taut foliation obtained by applying the construction of [3, §5] to the hierarchy. Apply the Rousserie-Thurston theorem [18], [20] to isotope Q to be transverse to \mathscr{F} except along saddle tangencies. Let \mathscr{L} be the lamination obtained by applying 4.17 to the given sutured manifold sequence. (\mathscr{L} is a union of leaves of \mathscr{F} .) Thicken \mathscr{L} to \mathscr{W} and isotope \mathscr{W} and M_n as in the proof of Lemma 4.25

(using this Q) to obtain the conclusions of Lemma 4.25 where conclusion (2) is replaced by “no component of $\partial\mathcal{W} \cap Q$ is a circle bounding a disc in $Q - \mathcal{W}$.” The proof follows by arguing as in the last paragraph of the proof of Lemma 4.27.

5. Finding an exotic planar surface

Let k be a knot in S^3 . The goal of this section, Lemma 5.1, is to show that either we can find a sutured manifold hierarchy of $(S^3 - \dot{N}(k), \partial N(k))$ such that every decomposing surface intersects $\partial N(k)$ in circles or we can find a sphere Q and a planar surface P in S^3 with some remarkable properties.

Lemma 5.1. *Let k be a knot in S^3 . Let*

$$(S^3 - \dot{N}(k), \partial N(k)) \xrightarrow{S_1} (M_1, \gamma_1) \rightsquigarrow \cdots \rightsquigarrow (M_n, \gamma_n) = (M, \gamma)$$

be a groomed sequence of sutured manifold decompositions such that $\partial S_i \cap \partial N(k)$ is a union of circles for each i , and if \hat{M} is the manifold obtained by attaching 2-handles to $E = E_n = \gamma \cap \partial N(k)$ (see 3.2) then $\partial \hat{M}$ is a union of 2-spheres. One of the following must hold:

(1) (M, γ) is a product sutured manifold.

(2) *There exists a planar surface $P \subset S^3 - \dot{N}(k)$ and a sphere $Q \subset S^3$ such that $|k \cap Q| = \mu > 0$, $P \cap \partial N(k)$ is a union of $v > 0$ coherently oriented longitudes, and $\lambda = \partial P - P \cap \partial N(k)$ is a simple closed curve which satisfies $|\lambda \cap Q| \leq \mu - 2$. Finally no component of $P - Q$ is a disc F with $\bar{F} \cap Q$ connected.*

Proof. If k is the unknot, then (1) holds. Otherwise apply Lemma 4.27 to our given sutured manifold sequence to obtain the 2-sphere Q and $q = \{q_1, \dots, q_r\}$. Our goal is to show that either (M, γ) is a product sutured manifold or we can find a planar surface $P \subset R(\gamma)$ such that ∂P is a union of components which are contained in E and a component λ disjoint from E which satisfies $|\lambda \cap Q| \leq \mu - 2$. Since $|\lambda \cap Q|$ and μ are even, it suffices to show $|\lambda \cap Q| < \mu$. Such a P satisfies all but possibly the last part of conclusion (2). The existence of a bad F would imply that some arc component δ of $Q \cap P$ is inessential in P . The conclusion of Lemma 4.27 implies that such a bad arc δ with $\partial\delta \subset E$ does not exist. A small isotopy of P removes bad arcs δ with endpoints in λ .

Let $(\hat{M}, \hat{\gamma})$ denote the sutured manifold obtained from (M, γ) by attaching a 2-handle to each component of E . View (M, γ) as a submanifold of $(\hat{M}, \hat{\gamma})$. Note that \hat{M} is contained in the manifold N obtained by performing zero frame surgery to k .

Define an equivalence relation \sim on the boundary sutures $E = \{A_1, \dots, A_w\}$ generated by the relation $A_i \sim A_j$ if $i = j$ or there exists a component D of q which is a product disc such that $D \cap A_i \neq \emptyset$ and $D \cap A_j \neq \emptyset$. Let X_1, \dots, X_t denote the equivalence classes. Note that each X_i intersects a unique component of each of $R_+(\gamma)$ and $R_-(\gamma)$.

Recall that product discs detect where a manifold is locally a product.

Case 1. If $p \in q$ is a product disc, then $p \cap (\gamma - E) = \emptyset$.

Case 1A. $t = 1$.

Proof. Let R_{\pm} be the disc components of $R_{\pm}(\hat{\gamma})$ which intersect $X = X_1$. No q_i is a disc p such that as one traverses ∂p the intersections of ∂p and γ alternate between intersections with X and intersections with $\gamma - X$. Otherwise \hat{M} , hence N the manifold obtained by doing zero frame surgery to k , contains a lens space summand contradicting the fact that $H_1(N) = \mathbb{Z}$. Concretely let $Y = X \cup \{q_i \in q \mid q_i \cap X \neq \emptyset, q_i \text{ is a product disc}\}$ and let U be the component of $\hat{M} - \hat{N}(Y)$ which contains p . Let $Z = (\hat{M} - \hat{U}) \cup N(\partial U)$. Topologically $Z = (D^2 \times S^1) \# (B^3)$. To see this, first pretend that X consists of a single suture. Now consider the effect of creating, one by one, more boundary sutures each of which is parallel to an existing one. By the hypothesis of Case 1, p is a 2-handle which attaches to Z and wraps $|p \cap X| > 1$ times around the S^1 factor. We conclude that \hat{M} contains a lens space summand.

Let D_+ be the disc R_+ reduced in size to eliminate trivial intersections with Q . (Conceivably $Q \cap R$ contains arcs with both endpoints in ∂R .) In a similar manner obtain D_- . Therefore for each i

$$|q_i \cap \partial D_+| + |q_i \cap \partial D_-| \leq 2[|\partial q_i \cap \partial \gamma|/4 - \chi(q_i)].$$

Summing over all the q_i 's and applying Lemma 4.27 we obtain

$$\sum |q_i \cap \partial D_+| + \sum |q_i \cap \partial D_-| \leq 2 \sum (|\partial q_i \cap \partial \gamma|/4 - \chi(q_i)) \leq 2(\mu - 1).$$

Therefore one of $D_+ \cap M$ or $D_- \cap M$ is the desired P .

Definitions 5.2. Define $F(X_i)$, the *fence* of X_i , to be $X_i \cup \{q_j \in q \mid q_j \cap X_i \neq \emptyset, q_j \text{ is a product disc}\}$. Note that the frontier $\delta N(F(X_i))$ is a union of annuli each of which separates \hat{M} , since $H_2(\hat{M}, \partial \hat{M}) = 0$.

Define $H(X_i)$, the *handle* of X_i , to be the largest codimension-0 submanifold of \hat{M} containing $N(F(X_i))$ such that $\partial H \subset (\partial \hat{M} - (\gamma - X_i)) \cup N(F(X_i))$. Note that in the proof of Case 1A, $H(X) \cup N(\partial \hat{M}) = Z$.

Define $C_+(X_i)$ (in a similar manner define $C_-(X_i)$), the *cap* of X_i , to be the smallest (up to isotopy) surface $C_+(X_i) \subset R_+(\hat{\gamma})$ such that

- (a) $N(F(X_i)) \cap R_+(\hat{\gamma}) \subset C_+(X_i)$,
- (b) if λ is a component of $(R(\gamma) - \hat{C}_+(X_i)) \cap Q$ such that $\partial \lambda \subset C_+(X_i)$, then λ is an essential arc in $R(\gamma) - \hat{C}_+(X_i)$, and

(c) if R is a component of $R(\gamma) - \mathring{C}_+(X_j)$ disjoint from $\gamma - E$, then $R \cap X_j \neq \emptyset$ for some j .

Figure 5.1 shows a picture of a neighborhood of a component of $R(\gamma)$ which intersects two distinct equivalence classes X_1 and X_2 . The members of X_1 are drawn as circles and the members of X_2 as ovals. The intersection of product discs and $R(\gamma)$ are drawn as solid lines while the intersections of other components of $Q \cap R(\gamma)$ are drawn as dotted lines. For clarity not all the components of $Q \cap R(\gamma)$ are shown. Note that $C_+(X_1)$ is a shaded disc and $C_+(X_2)$ is a three times punctured sphere.

Remark 5.3. By the tautness of (M, γ) it follows that if $C_+(X)$ is a disc, then so is $C_-(X)$. In this case $H(X)$ is a $D^2 \times I$ such that $H(X) \cap \partial \hat{M} = D^2 \times \{0, 1\}$, i.e., $H(X)$ is a 1-handle.

Case 1B. There exists a component R of $R(\hat{\gamma}) - \mathring{C}_\pm(X_j)$ which is a disc and intersects a unique X_j . (Figure 5.1 contains such an R .)

Proof. Here the desired P will be one of $C_\pm(X_i)$. The proof of Case 1B follows by pretending that $X = X_i$, and then (after one modification) mimicking the proof of Case 1A. We need to show (as in the proof of Case 1A) that

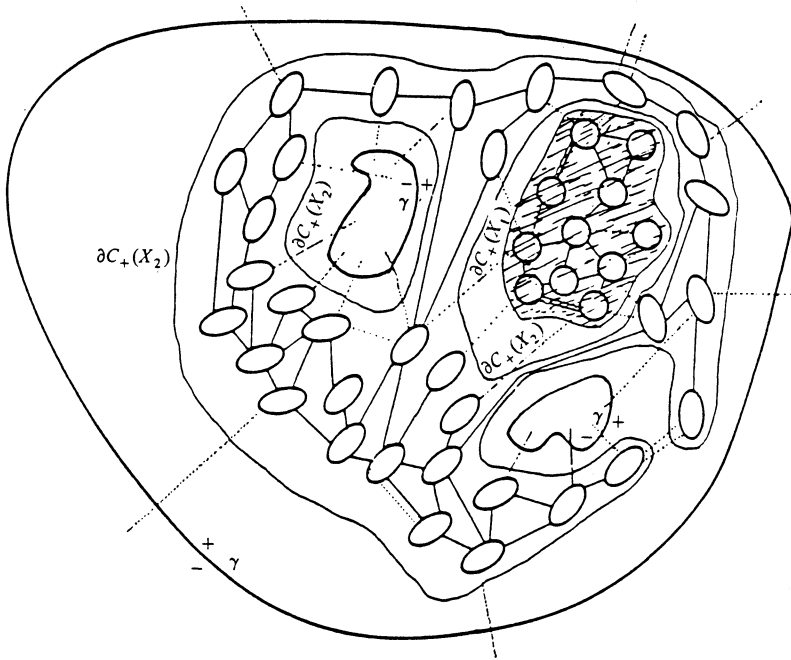

FIGURE 5.1

no bad p exists. In this setting let U be the component of $\hat{M} - (\hat{H}(X_i) \cup \hat{H}(X_j))$ which contains p . Let $Z = (\hat{M} - \hat{U}) \cup N(\partial U)$. Topologically $Z = (D^2 \times S^1) \# (3\text{-manifold})$. This follows from Remark 5.3, the fact that $\partial \hat{M}$ is a union of 2-spheres and the observation that for each r , $\delta N(F(X_r))$ is a union of annuli each of which separates \hat{M} . The proof now continues as before.

Case 1C. There exists a disc R which intersects exactly two X 's, say X_1 and X_2 , and is either a component of $R(\hat{\gamma}) - \hat{C}_\pm(X_j)$ for some j or is a component of $R(\hat{\gamma})$.

Proof. In light of Case 1B and its reduction to Case 1A it suffices to consider the case that R is a component of $R_+(\hat{\gamma})$ and the $C_\pm(X_i)$'s are discs for $i = 1, 2$. To prove Case 1C we will first show that for some $i \in \{1, 2\}$ there exists no q_j such that q_j is a disc and as one traverses ∂q_j one alternately intersects X_i and $\gamma - X_i$. Suppose that for $i \in \{1, 2\}$ such components of $Q \cap M$ exist. Call them respectively q_1 and q_2 . Let $a_{ij} = |q_i \cap X_j|$.

If either $a_{11} = a_{12}$ or $a_{12} = 0$, then one could find a lens space summand in \hat{M} with H_1 of order a_{11} . In the latter case apply the argument of Case 1A. In the former case let $Z = N(R) \cup H(X_1) \cup H(X_2)$ which is homeomorphic to $D^2 \times S^1$. q_1 is a 2-handle which attaches to Z and wraps a_{11} times around the S^1 factor. This contradicts the fact that $H_1(N) = \mathbb{Z}$.

We now assume that $a_{11} > a_{12}$ and $a_{22} < a_{21}$. In this case $\hat{M} = M_1 \# M_2$ where M_2 is a closed oriented 3-manifold obtained by attaching two 2-handles (q_1 and q_2) to the (genus 2 handlebody) $\# B^3$ which is equal to $N(\partial M) \cup H(X_1) \cup H(X_2)$. $H_1(M_2)$ has the presentation

$$H_1(M_2) = \{x_1, x_2 \mid a_{11}x_1 - a_{12}x_2, a_{21}x_1 - a_{22}x_2\}.$$

This implies that its order is $a_{11}a_{22} - a_{12}a_{21}$ which is finite but greater than one. Again this contradicts the fact that $H_1(N) = \mathbb{Z}$.

We now assume that there exists no disc q_j such that as one traverses ∂q_j one alternately intersects X_1 and $\gamma - X_1$. Define $G_\pm \subset R(\hat{\gamma})$ by $G_- = C_-(X_1)$ and $G_+ = R$ if there exists an arc $\delta \subset R$ such that $\delta \not\subset C_+(X_1)$ but $\delta \cap C_+(X_1) \neq \emptyset$ and $G_+ = C_+(X_1)$ if no such arc exists. As in Case 1A assume that G_+ has been reduced in size to eliminate trivial intersections with Q . Observe that for every i

$$|q_i \cap \partial G_+| + |q_i \cap \partial G_-| \leq 2[|\partial q_i \cap \partial \gamma|/4 - \chi(q_i)].$$

Arguing as in Case 1A we find that the desired P is one of $G_+ \cap M$ or $G_- \cap M$.

Case 1D. There exists a disc R which intersects $t \geq 3$ X 's, say X_1, X_2, \dots, X_t , and is either a component of $R(\hat{\gamma})$ or a component of $R(\hat{\gamma}) - \hat{C}_\pm(X_j)$ for some j .

Proof. Assume by induction that Case 1D is true for $s < t$ and that $R \subset R_+(\hat{\gamma})$. If some $C_+(X_i)$ was not a disc, then one could find a disc component of $R(\hat{\gamma}) - \mathring{C}_+(X_j)$ which contained fewer X 's so the result would follow by induction. Therefore we will assume that all the $C_+(X_i)$'s are discs.

Let $\Lambda = \partial R \cup \partial C_+(X_1) \cup \dots \cup \partial C_+(X_t)$. Let $n_0 = |\partial R \cap Q|$ and $n_i = |\partial C_+(X_i) \cap Q|$. For each i , $|q_i \cap \Lambda| \leq 2(|\partial q_i \cap \partial \gamma|/4 - \chi(q_i))$ unless q_i is a disc and $|\partial q_i \cap \partial \gamma|/2 = |q_i \cap \Lambda|$ in which case the inequality is off by 2. Therefore by Lemma 4.27 and the hypothesis of Case 1

$$|q_i \cap \Lambda| \leq 2(|\partial q_i \cap \partial \gamma|/4 - \chi(q_i)) + |q_i \cap \Lambda|/2.$$

Therefore,

$$\sum_{r=0}^t n_r = \sum_{i=1}^t |q_i \cap \Lambda| \leq 2(\mu - 1) + \frac{1}{2} \sum_{r=0}^t n_r$$

so $\sum n_r \leq 4(\mu - 1)$, hence $n_i \leq (\mu - 1)$ for some i . Our desired P is R if $i = 0$ or $C_+(X_i)$ if $i > 0$.

Case 2. There exists at least one product disc $q_i \in q$ such that $q_i \cap (\gamma - E) \neq \emptyset$.

Proof. Let X_1, X_2, \dots, X_s be the equivalent classes such that for each X_j , $1 \leq j \leq s$, there exists a product disc q_i such that $q_i \cap X_j \neq \emptyset$, and $q_i \cap (\gamma - E) \neq \emptyset$. Let $E' = E - \{X_1, X_2, \dots, X_s\}$. Let $q' = \{q_i | q_i \text{ is a product disc and } q_i \cap (\gamma - E') \neq \emptyset\}$.

If $E' = \emptyset$, then (M, γ) is a product sutured manifold and conclusion (1) of Lemma 5.1 holds. To see this let q'' be a maximal subset of q such that q'' does not separate M . Since $H_2(\hat{M}, \partial \hat{M}) = 0$ and $\partial \hat{M}$ is a union of S^2 's, each component of q'' nontrivially intersects two distinct components of γ , one of which is contained in E . If $A \in E$ and D is a component of q'' such that $A \cap D \neq \emptyset$, then the sutured manifold obtained by decomposing (M, γ) along D is equal to the sutured manifold obtained by attaching a 2-handle to A (see Figure 5.2). In a similar manner decomposing (M, γ) along q'' yields the taut sutured manifold (M'', γ'') which is equal to $(\hat{M}, \hat{\gamma})$. The tautness of $(\hat{M}, \hat{\gamma})$ and the fact that $\partial \hat{M}$ is a union of S^2 's imply that $(\hat{M}, \hat{\gamma})$, hence (M'', γ'') equals $(D^2 \times I, \partial D^2 \times I)$. We conclude that (M, γ) is a product sutured manifold.

Now assume that $E' \neq \emptyset$. The sutured manifold (M', γ') obtained by decomposing (M, γ) along q' is taut by [3, Lemma 4.12]. View $q - q'$ as lying in (M', γ') and observe that (M', γ') enjoys all the properties that (M, γ) had, e.g., if \hat{M}' equals M' with 2-handles attached along E' , then \hat{M}' is contained

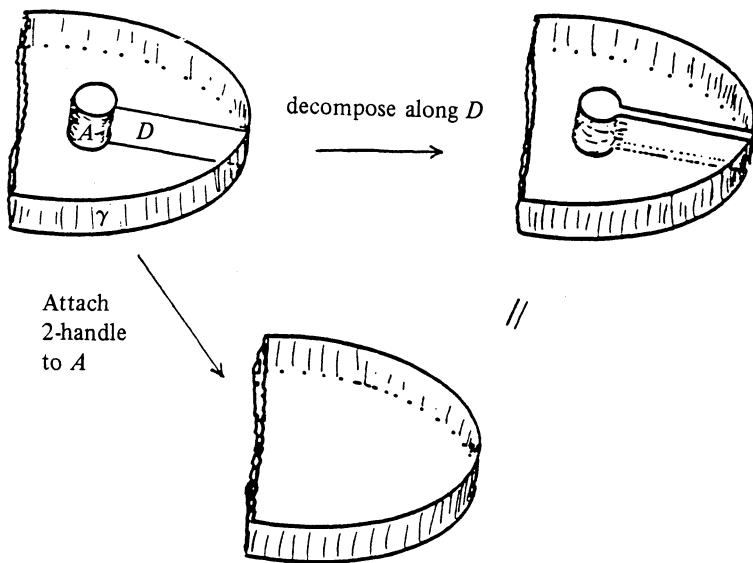

FIGURE 5.2

in the 0-frame manifold N , $\partial\hat{M}'$ is a union of 2-spheres, and

$$\sum_{q=q'} \frac{|\partial q_i \cap \partial\gamma'|}{4} - \chi(q_i) \leq \mu - 1.$$

(M', γ') is naturally embedded in (M, γ) so if we can find a planar surface $P \subset R(\gamma')$ such that ∂P is a union of components which are contained in E' and a single component λ' disjoint from E' which satisfies $|\lambda' \cap (q - q')| = |\lambda' \cap Q| \leq \mu - 2$, then P is our desired planar surface. Now apply Case 1 to (M', γ') to find P and conclude that (2) of Lemma 5.1 holds.

6. The combinatorial lemma

Lemma 6.1. *There does not exist a graph G in S^2 with the following properties.*

- (1) G has $v + 1$ vertices. v vertices are valence μ ($\mu \neq 0$ even) and one vertex w has valence m ($0 \leq m \leq \mu - 2$).
- (2) The ends of edges emanating from a given valence n vertex are labeled in order clockwise $1, 2, \dots, \mu \bmod \mu$.
- (3) If both ends of an edge are labeled, then one label is even and the other odd.

(4) If D is the closure of a disc in $S^2 - G$, $w \cap D = \emptyset$, and n_1, n_2, \dots, n_{2r} ($r \geq 1$) are the labels read in order as one traverses the labels of ∂D starting from a vertex, then $(n_1, \dots, n_{2r}) \neq (j, j - 1, \dots, j, j - 1) \pmod{\mu}$.

Proof. Let $l(e, v)$ denote the label of edge e at vertex v if e intersects v exactly once. If e intersects a unique valence μ vertex or v is understood, then denote the label by $l(e)$.

We will first show that if such a graph exists, then one exists such that valence $w = 0$. If some edge has both edges in w , then delete it from G . Let e_1, \dots, e_m be the edges emanating from w cyclically ordered so that e_i appears to the left of e_{i+1} . Since $m < \mu$ there exists an $i \pmod m$ such that $l(e_i) \neq (l(e_{i+1}) - 1) \pmod{\mu}$. Let H be the graph obtained by deleting e_{i+1} and e_i from G and creating a new edge e (Figure 6.1) whose endpoints and corresponding end labels on the valence μ vertices are those of e_i and e_{i+1} . H satisfies the properties that G had, but the valence of w has been reduced. Now we can assume that valence w equals zero.

Property (4) implies that there does not exist a disc $D \subset S^2 - G$ whose closure is bounded by a single edge and whose endpoints lie on a unique valence μ vertex. It also implies that no two vertices are connected by $1 + \mu/2$ parallel edges. It follows that no such graph G exists with $v \leq 2$.

We will show that if a graph G exists with $v > 2$, then a graph H exists with fewer valence μ vertices. The lemma will then follow by induction.

If we can find a simple closed curve δ in S^2 which is disjoint from the vertices of G , intersects the edges of G in fewer than μ points, and each component of $S^2 - \delta$ contains a valence μ vertex, then the desired graph H is obtained from G by collapsing to a point $F \cap G$ where F is the disc bounded by δ and containing w . If either some edge of G has endpoints on the same vertex or if the closure of a component of $S^2 - G$ is not an embedded disc, then one easily finds such a δ .

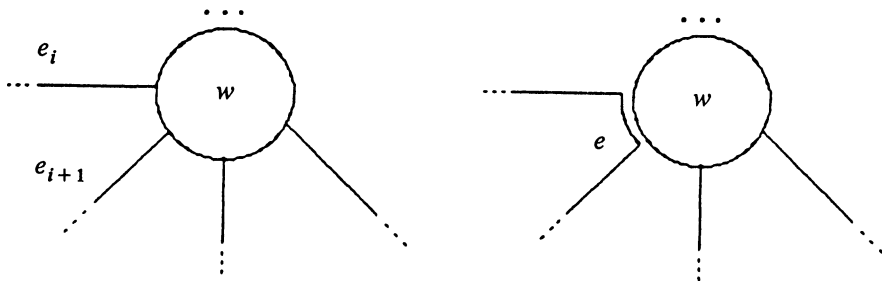

FIGURE 6.1

Let $\lambda_1, \dots, \lambda_v$ denote the valence μ vertices.

Let F be the closure of the component of $S^2 - G$ which contains w . Let D be the closure of any component of $S^2 - G$ such that ∂D intersects at least three vertices, two of which (say v_1 and v_r) are adjacent (in ∂D) and contained in F . Let v_1, \dots, v_r be the vertices encountered as one traverses ∂D clockwise. Let e_i be the edge of $G \cap D$ which connects v_i to $v_{i+1} \pmod r$.

Construction of graphs H_1, H_2 . (Figure 6.2) H_1 (resp. H_2) is obtained from G by removing edges e_1 and e_r (resp. e_{r-1}, e_r) from G and attaching a new edge e between vertices v_2 and v_r (resp. v_1 and v_{r-1}). The v_i end of e , $i \in \{2, r\}$ (resp. $i \in \{1, r-1\}$), is given the label of the v_i end of the appropriate e_j . Now delete w and rename v_1 (resp. v_r) to be w .

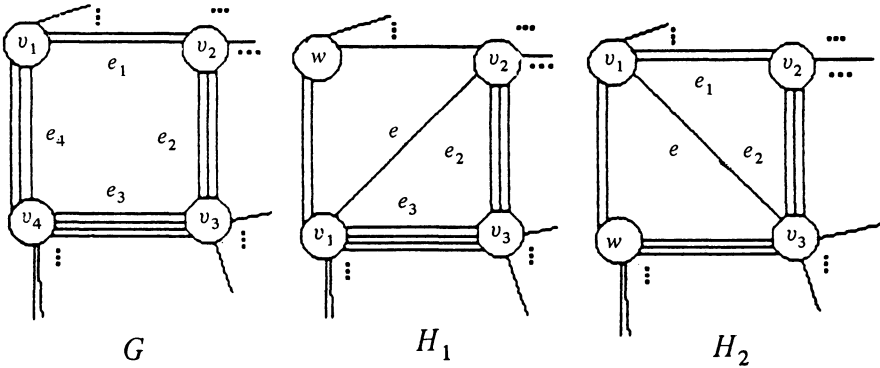

FIGURE 6.2

Claim. One of graphs H_1 and H_2 satisfy properties (1)–(4).

Proof of Claim. All but (4) clearly hold for both H_1 and H_2 . Note that w has valence $\mu - 2$. (4) could only fail for H_1 if it failed for the disc E_1 whose interior is a component of $S^2 - H_1$ and which is bounded by e, e_2, \dots, e_{r-1} . In that case starting at the midpoint of e the edge end labels read clockwise would be $(s, s-1, \dots, s, s-1), \pmod{\mu}$. Necessarily

$$l(e_1, v_1) = t - 1 \neq (s - 1), \pmod{\mu},$$

else property (4) will fail for the disc D , hence the graph G . The edge end labels of the disc E_2 whose interior is a component of $S^2 - H_2$, bounded by e, e_1, \dots, e_{r-2} are $(t, t-1, s, s-1, \dots, s, s-1), \pmod{\mu}$ which satisfies property (4). It follows that property (4) holds for H_2 .

Remark. Lemma 6.1 can also be deduced from the independently obtained Lemmas 2.61, 2.62 of [1].

7. Proof of Theorem 3.1

Let k be a knot in S^3 . Let S be a minimal genus Seifert surface for k .

Step 1. The goal of this step is to do the best we can to construct the desired foliation on $S^3 - \dot{N}(k)$. More precisely, find a groomed sequence of sutured manifold decompositions

$$(S^3 - \dot{N}(k), \partial N(k)) \xrightarrow{S_1=S} (M_1, \gamma_1) \rightsquigarrow \cdots \rightsquigarrow^{S_n} (M_n, \gamma_n)$$

such that for $1 \leq i \leq n$

(1) S_i is connected, $\partial S_i \neq \emptyset$, and $0 \neq [S_i, \partial S_i] \in H_2(M_{i-1}, \partial M_{i-1})$.

(2) $\partial N(k) \cap S_i$ is a union of simple closed curves.

(3) If $(\hat{M}_n, \hat{\gamma}_n)$ denotes the sutured manifold obtained by attaching 2-handles to (M_n, γ_n) along $E_n = \gamma_n \cap \partial N(k)$ (here view $\hat{M}_n \subset S^3 - \dot{N}(k)$), then $\partial \hat{M}_n$ is a union of 2-spheres.

Proof. First decompose $(S^3 - \dot{N}(k), \partial N(k))$ along S , then apply Lemma 3.6 to (M_1, γ_1) .

Step 2. The goal of this step is to find an essential 2-sphere in S^3 . More precisely, find a 2-sphere Q in S^3 such that $|Q \cap k| = \mu > 0$, Q is transverse to M_n , each arc component of $Q \cap \gamma_n$ (resp. $Q \cap (\partial M_n - \dot{E}_n)$) is essential in γ_n (resp. $\partial M_n - \dot{E}_n$), $Q \cap M_n = \{q_1, \dots, q_r\} \cup D$ where each q_i is a connected surface and either $D = \emptyset$ or D is a disc and $D \cap \partial \gamma = \emptyset$, and

$$\sum_{i=1}^r \frac{|\partial q_i \cap \partial \gamma_n|}{4} - \chi(q_i) \leq \mu - 1.$$

Finally each q_i contributes a nonnegative number to the above summation.

Proof. Apply Lemma 4.27.

Step 3. Either we can construct the desired foliation on $S^3 - \dot{N}(k)$ or there exists an exotic planar surface in S^3 , i.e., there exist a planar surface $P \subset S^3 - \dot{N}(k)$ and a sphere $Q \subset S^3$ such that $|k \cap Q| = \mu > 0$, $P \cap \partial N(k)$ is a union of $v > 0$ coherently oriented longitudes, and $\lambda = \partial P - \partial N(k)$ is a simple closed curve which satisfies $|\lambda \cap Q| \leq \mu - 2$. Finally, no component of $P - Q$ is a disc F with $F \cap Q$ connected.

Proof. Apply Lemma 5.1 to conclude that either P exists or (M_n, γ_n) is a product sutured manifold. If the latter holds, then apply the construction of \mathcal{F}_0 in [3, pp. 471–477] to the sutured manifold sequence of Step 1 to obtain the desired foliation \mathcal{F} (compare Lemma 3.7).

Step 4. No exotic planar surface exists.

Proof. Construct a graph G in S^2 as follows. Contract each component of ∂P to a point to create a S^2 . The vertices of G correspond to the components of ∂P . The edges of G correspond to the arcs $Q \cap P$. G has $v + 1 > 1$ vertices

of which v are valence μ and 1 (called λ) is valence $\leq \mu - 2$. Label the points of $k \cap Q$ $1, 2, \dots, \mu \bmod \mu$ by starting at a point of $k \cap Q$ and labelling it 1 and then following the knot to label the other points of intersection in sequence. If some endpoint ρ of the edge e of G lies on a valence μ vertex, then give the ρ end of e the label corresponding to the point of $\rho \in Q \cap k$.

After possibly reversing the orientation on k the labeled graph G satisfies all but possibly properties (3) and (4) of the hypothesis of Lemma 6.1. Hypothesis (3) holds because P is oriented and all the components of $P \cap \partial N(k)$ are oriented in the same way. Hypothesis (4) holds as follows. If F is a disc contradicting hypothesis (4), then either $r = 1$ or $r > 1$. The former corresponds to a disc component of $P - Q$ and the connectivity of $F \cap Q$ contradicts the conclusions of Step 3. The latter implies that S^3 contains a lens space summand. To see this think of Q as the boundary of a 0-handle, the piece of knot between points of $k \cap Q$ labelled j and $j - 1$ as 1-handles and F as a 2-handle. The subcomplex formed by these three cells is a punctured lens space.

Lemma 6.1 implies that such a graph G does not exist.

Remark 7.1. The technique of translating a topology problem into a combinatorial problem as in Step 4 was learned from the two *very* fine preprints of Scharlemann, *Tunnel number one knots are doubly prime* and *Tunnel number one knots satisfy the Poenaru conjecture*, which were combined into [19].

As far as I can tell, the first person to use the combinatorics of labelled graphs to solve problems in 3-manifold theory was Litherland [14]. Of course, using the existence of a family of (possibly immersed) surfaces in a 3-manifold M to derive information about M has always been a key element in the study of 3-manifold topology.

8. More applications

Definitions 8.1. Let k be a knot in a closed oriented 3-manifold N . A *longitude* of k is the unique (up to isotopy) essential simple closed curve λ in $\partial N(k)$ such that (with any orientation on λ) $0 = [\lambda] \in H_1(N - \dot{N}(k); \mathbb{Q})$. The manifold M is obtained by *zero frame surgery* on a knot k in N , if it is obtained by performing Dehn surgery to the longitude. Note that if N is a homology sphere, then M is the unique manifold obtained by Dehn surgery on k which is a homology $S^2 \times S^1$.

Corollary 8.2. *Let S be a minimal genus Seifert surface for a knot k in S^3 . The manifold M obtained by performing zero frame surgery to k possesses a taut*

finite depth foliation \mathcal{F} such that the core of the filling is transverse to \mathcal{F} and intersects every leaf of \mathcal{F} . \mathcal{F} has a compact leaf \hat{S} such that $\hat{S} - \hat{N}(k) = S$. In particular genus \hat{S} is equal to the genus of k .

Proof. Apply Theorem 3.1 to find a taut foliation \mathcal{F}' of $S^3 - \hat{N}(k)$ such that $\mathcal{F}' \mid \partial N(k)$ is a foliation by longitudes and such that S is a leaf. Cap off leaves of $\mathcal{F}' \mid \partial N(k)$ by discs to extend \mathcal{F}' to a taut foliation \mathcal{F} on M . Cap off S by a disc to create \hat{S} . By construction every leaf of \mathcal{F}' intersects $\partial N(k)$ so the core of the filling intersects each leaf of \mathcal{F} . Since genus $k = \text{genus } S = \text{genus } \hat{S}$ the result follows. Note that \hat{S} generates $H_2(M)$.

Corollary 8.3. *If M is obtained by performing zero frame surgery on a knot in S^3 , then M is prime and $\text{genus } k = \min\{\text{genus } S \mid S \text{ is a nonseparating oriented embedded surface in } M\}$.*

Proof. Apply the work of Novikov, Reeb, and Alexander to the conclusions of Corollary 8.2 to conclude that M is prime. By Thurston [22] and Corollary 8.2 a genus k surface $\hat{S} \subset M$ is a Thurston norm minimizing surface in M . Since \hat{S} generates $H_2(M)$, the result follows.

Remarks 8.3 $\frac{1}{2}$ (September 1986). (1) Our proof of Corollary 8.3 consists of invoking the following three results A, B, C. M. Scharlemann has observed that results B and C can simply be replaced by our Lemma 3.5 [3].

Let S be a minimal genus surface for k .

Explanation of A, B, and C.

A. Either k is unknotted or there exists a sutured manifold hierarchy

$$(M, \emptyset) \xrightarrow{S_1 = \hat{S}} (\hat{M}_1, \hat{\gamma}_1) \rightsquigarrow \cdots \rightsquigarrow (\hat{M}_n, \hat{\gamma}_n) \quad (\text{see Notation 3.3 and } \S 7).$$

B. Lemma 3.7.

C. The theorems of Reeb, Novikov, and Thurston (see [3, 2.5 and 2.8]).

The point is that arguments B and C are superfluous, for if $k \neq 0$, [3, Lemma 3.5] (see also [6], Lemma 0.4) applied to the sutured manifold sequence of A implies that M is irreducible and $(\hat{M}_1, \hat{\gamma}_1)$ is taut. Lemma 3.6 of [3] implies that \hat{S} is a minimal genus surface in M . (For otherwise there exists an incompressible surface T in M disjoint from and homologous to \hat{S} such that $\chi(T) > \chi(\hat{S})$. T viewed in M_1 contradicts the tautness of $(\hat{M}_1, \hat{\gamma}_1)$.) Lemmas 3.5 and 3.6 are used in the proof of A.

(2) We leave as an exercise to the reader the observation that Lemmas 3.5 and 3.6 imply, for the case of finite depth foliations, Thurston's and Novikov's theorems.

Problem 8.4. To what extent is a knot k determined by the manifold obtained by zero frame surgery on k ?

Remark 8.5. The *Property R* conjecture asserts that zero frame surgery on a nontrivial knot k in S^3 does not yield $S^2 \times S^1$. Property R can also be expressed as follows:

$$D^2 \times S^1 = \{ \text{“trivial” knot complement} \} \\ = \{ \text{complements of knots in } S^3 \} \cap \{ \text{Complements of knots in } S^2 \times S^1 \}.$$

The *Poenaru* conjecture asserts that zero frame surgery on a nontrivial knot k in S^3 does not yield $S^2 \times S^1 \# M^3$.

Corollary 8.3 gives positive proofs of these conjectures.

The following result was proven (modulo Corollary 8.3) twelve years ago. Its statement and proof are due to Poenaru [17].

Corollary 8.6 (Poenaru 1974). *If V is the 4-manifold obtained by attaching a 2-handle and a 3-handle to B^4 and $H_2(V) = 0$, then $V = B^4$.*

Proof. Let W be the 4-manifold obtained by attaching a 2-handle to B^4 . If one can attach a 3-handle to W so that the resulting 4-manifold V satisfies $H_2(V) = 0$, then two applications of the Mayer-Vietoris sequence yield the facts: $H_2(W) = \mathbb{Z}$, the inclusion $i: H_2(\partial W) \rightarrow H_2(W)$ is an isomorphism, and $H_2(\partial W)$ is generated by a 2-sphere. Since $H_2(\partial W) = \mathbb{Z}$, ∂W is obtained by zero frame surgery on a knot k in S^3 . By Corollary 8.3, k is unknotted. Therefore $W = S^2 \times D^2$ and $V = B^4$.

Problem 8.7 (Poenaru 1959). *If a 4-manifold V is obtained by attaching q 2-handles and q 3-handles to B^4 and $H_2(V) = 0$, then: Is $V = B^4$?*

Theorem 8.8. *Let k be a nontrivial knot in S^3 . Let M be the manifold obtained by performing zero frame surgery to k . Let ω be a generator of $H_2(M)$ and z a generator of $H_2(S^3 - \dot{N}(k), \partial N(k))$. Then the following numbers are equal.*

- (1) $\text{genus } k = \{ \min g \mid k \text{ bounds an embedded surface of genus } g \}$.
- (2) $\text{singular genus } k = \{ \min g \mid \text{there exists a map } f: S \rightarrow S^3 \text{ such that } f^{-1}(k) = \partial S, f|_{\partial S} \text{ is an embedding onto } k, \text{ and } \text{genus } S = g \}$.
- (3) $\{ \min g \mid \text{there exists a properly embedded surface } S \text{ of genus } g \text{ in } S^3 - \dot{N}(k) \text{ such that } |\partial S| \text{ is odd} \}$.
- (4) $\{ \min g \mid \text{there exists a proper map } f: S \rightarrow S^3 - \dot{N}(k) \text{ such that } \text{genus } S = g, |\partial S| \text{ is odd, and } f|_{\partial S} \text{ is an embedding} \}$.
- (5) $(x_s(z) + 1)/2$, where x_s denotes the singular norm (see [3, 6.16]).
- (6) $(1 + g(z))/2$, where g denotes the Gromov norm (see [3, 6.17]).
- (7) $\{ \min g \mid \text{there exists an embedded surface } S \text{ in } M \text{ such that } [S] = \omega \in H_2(M) \}$.
- (8) $\{ \min g \mid \text{there exists a } f: S \rightarrow M \text{ such that } \text{genus } S = g \text{ and } f_*[S] = \omega \}$.
- (9) $(x_s(\omega) + 2)/2$.
- (10) $(2 + g(\omega))/2$ where g denotes the Gromov norm.

Proof. By Corollary 8.3, (1) = (7). If S is a minimal genus surface for k and S' its extension to M , then $z = [S]$ and $\omega = [S']$. By Corollary 6.18 of [3], $x_s(z) = |\chi(S)|$, $g(z) = 2|\chi(S)|$, $x_s(\omega) = |\chi(S')|$, and $g(\omega) = 2|\chi(S')|$. Therefore (1) \geq (2) \geq (4) \geq (5) = (6) = (1) = (7) = (3) \geq (8) \geq (9) = (10) = (7).

Theorem 8.9. *Let k be a homologically trivial knot in a reducible 3-manifold M such that $H_1(M)$ is torsion free and $M - k$ is irreducible. If S is a minimal genus Seifert surface for k , then there exists a taut finite depth foliation \mathcal{F} of $M - \dot{N}(k)$ such that $\mathcal{F} \upharpoonright \partial N(k)$ is a foliation by circles which are longitudes and S is a leaf of \mathcal{F} .*

Proof. The proof of Theorem 8.9 is exactly the proof of Theorem 3.1 with the following modifications. We follow the program of §7. First replace each occurrence of S^3 in §7 by M .

Step 1 follows exactly as before.

Step 2 follows by Lemma 4.28. This step uses the reducibility hypothesis.

Step 3 follows exactly as before. Note that the proof of Step 3 uses the fact that the homology of the manifold obtained by doing zero frame surgery to k is torsion free.

Step 4 follows exactly as before. The proof of Step 4 uses the fact that $H_1(M)$ is torsion free.

Corollary 8.10. *If k is a knot in S^3 such that genus $k > 1$, and S is a minimal genus Seifert surface for k , then there exists C^∞ , taut foliations \mathcal{F}_i , $i = 1, 2$, of $S^3 - \dot{N}(k)$ such that $\mathcal{F}_i \upharpoonright \partial N(k)$ is a foliation by circles which are longitudes, S is a leaf of \mathcal{F}_1 and no leaf of \mathcal{F}_2 is compact.*

Proof. Lemma 3.6 applied to the knot k in S^3 yields a sequence of sutured manifold decompositions which, by the proof of Theorem 3.1 is a sutured manifold hierarchy of $(S^3 - \dot{N}(k), \partial N(k))$. Apply the construction of \mathcal{F}_1 of [3, pp. 471–477] to this hierarchy to obtain the C^∞ taut foliation (which we also call) \mathcal{F}_1 . Note that the construction of \mathcal{F}_1 is similar to the construction, on these same pages, which yielded the foliation \mathcal{F} of Theorem 3.1; however, the construction of \mathcal{F}_1 requires a smoothing operation at each step of the construction. When genus $k = 1$, this smoothing operation would possibly create nontrivial holonomy on $\partial N(k)$.

To obtain \mathcal{F}_2 apply the opening up operation of Step 2 of [3, p. 481] to the foliation \mathcal{F}_1 which by construction has the unique compact leaf S .

Corollary 8.11. *If k is a knot in S^3 such that genus $k > 1$, then there exists a C^∞ taut foliation \mathcal{F} of S^3 with a single Reeb component whose core is isotopic to k .*

Proof. Spiral, in a neighborhood of $\partial N(k)$, the foliation \mathcal{F}_1 constructed in Corollary 8.10 to construct a smooth foliation \mathcal{F}' on $S^3 - \dot{N}(k)$ such that

$\partial N(k)$ is the unique compact leaf. Extend \mathcal{F}' to a foliation \mathcal{F} on S^3 by plugging in a Reeb component.

Questions 8.12. If genus $k = 1$, does there exist a C^∞ foliation \mathcal{F} on S^3 such that \mathcal{F} has a unique Reeb component whose core is k ? Does Corollary 8.10 hold for genus 1 knots?

It follows from Theorem 3.1 that C^0 foliations exist. By [4] the answers are yes if k is an alternating knot.

Remark 8.13. For knots of genus > 1 versions of Corollary 8.2 and Theorem 8.9 exist where the resulting foliations are C^∞ rather than finite depth. These foliations can be slightly perturbed away from $N(k)$ to create smooth new ones which have no compact leaves.

Lemma 8.14. *If k is a knot and*

$$(S^3 - \mathring{N}(k), \partial N(k)) \xrightarrow{S_1} (M_1, \gamma_1) \xrightarrow{S_2} \cdots \xrightarrow{S_n} (M_n, \gamma_n) = (M, \gamma)$$

is a (well) groomed sutured manifold sequence, such that $S_i \cap \partial N(k)$ is a union of circles for each i , then this sequence can be extended to a (well) groomed sutured manifold hierarchy.

Proof. Apply the proof of Theorem 3.1.

Corollary 8.15. *If \mathcal{L} is a finite depth finite leaved lamination on $S^3 - \mathring{N}(k)$ such that \mathcal{L} is transverse to $\partial N(k)$, $\mathcal{L} \cap \partial N(k)$ is a union of circles, and \mathcal{L} is a union of leaves of a taut foliation \mathcal{F}' of $S^3 - \mathring{N}(k)$, then there exists a taut foliation \mathcal{F} of $S^3 - \mathring{N}(k)$ extending \mathcal{L} such that $\mathcal{F} | \partial N(k)$ is a foliation by circles.*

Proof. There exists a groomed sutured manifold sequence

$$(S^3 - \mathring{N}(k), \partial N(k)) \xrightarrow{S_1} (M_1, \gamma_1) \xrightarrow{S_2} \cdots \xrightarrow{S_n} (M_n, \gamma_n)$$

with the property that the lamination obtained by applying Description 2 of 4.17 is \mathcal{L} . To see that each (M_i, γ_i) is taut first apply Corollary 5.3 of [3] to conclude that (M_n, γ_n) is taut and then apply Lemma 3.5 of [3] to conclude that the others are taut. By Lemma 8.14 this sequence extends to a sutured manifold hierarchy, hence by either of Description 2 or Lemma 3.8 \mathcal{L} extends to the desired \mathcal{F} .

Remark 8.16. The previous corollary could be expressed slightly differently as follows yet be proved identically.

If \mathcal{L} is a finite depth finite leaved lamination with the property that each incompressible compact portion S of each leaf L of \mathcal{L} is Thurston norm minimizing (rel $\partial S \cup \partial N(k)$), then \mathcal{L} extends to a taut finite depth foliation \mathcal{F} such that $\mathcal{F} | \partial N(k)$ is a foliation by circles.

Definition 8.17. A sutured manifold (M, γ) has the *groomed decomposition extension property* with respect to a subset E (see 3.2) of γ if for every groomed sutured manifold decomposition sequence

$$(M, \gamma) \xrightarrow{S_1} (M_1, \gamma_1) \xrightarrow{S_2} \cdots \xrightarrow{S_n} (M_n, \gamma_n)$$

such that $S_i \cap E$ is a union of simple closed curves, then the sequence

$$(\hat{M}, \hat{\gamma}) \xrightarrow{\hat{S}_1} (\hat{M}_1, \hat{\gamma}_1) \xrightarrow{\hat{S}_2} \cdots \xrightarrow{\hat{S}_n} (\hat{M}_n, \hat{\gamma}_n)$$

obtained by attaching 2-handles to each component of $\gamma_i \cap E$ to create $(\hat{M}_i, \hat{\gamma}_i)$ and attaching discs to each component of $S_i \cap E$ to create \hat{S}_i is groomed.

Example 8.18. If k is a knot, then the sutured manifold $(S^3 - \mathring{N}(k), \partial N(k))$ has the groomed decomposition extension property with respect to $\partial N(k)$ by Lemma 8.14.

Corollary 8.19. k is a fibered knot in S^3 if and only if the manifold M obtained by performing zero frame surgery to k fibers over S^1 .

Remark 8.20. Corollary 8.19 does not immediately follow from Theorem 3.1. The point is that a priori there might exist a depth 1 foliation \mathcal{F} of M which consists of one compact leaf F (a fiber) and other leaves which spiral around towards the compact one. k could be a knot which is transverse to \mathcal{F} yet isotopic to a curve which begins at F , goes a short distance transverse to \mathcal{F} , then traces out a very long and complicated route on a noncompact leaf, then goes a short distance transverse to \mathcal{F} before returning to F . Such a knot (e.g., Figure 8.1) would not be transverse to the fibration of M , hence would contradict the conclusions of the theorem.

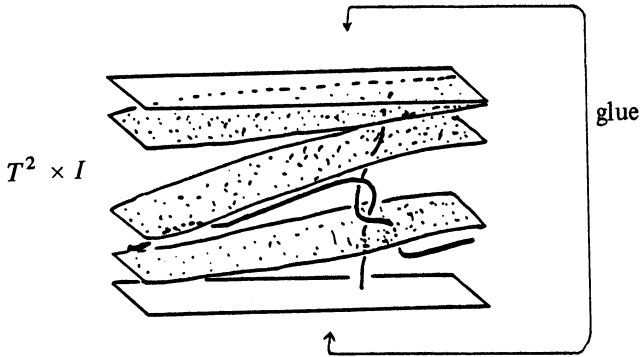

FIGURE 8.1

Definition 8.21. Let k be a properly embedded arc or knot in M . k is *prime* if for each separating 2-sphere $Q \subset M$ such that $|Q \cap k| = 2$, there exists a component λ of $k - Q$ such that $\text{rel } \partial \bar{\lambda}, \bar{\lambda}$ is isotopic to an embedded arc in Q .

Lemma 8.22. Let k be a prime properly embedded arc in $S \times I$, where S is a compact oriented surface such that $k \cap (S \times i) \neq \emptyset$ for $i = 0, 1$. If (M, γ) is the sutured manifold defined by $M = S \times I - \dot{N}(k)$, $R_+(\gamma) = S \times 1 - \dot{N}(k)$, and $R_-(\gamma) = S \times 0 - \dot{N}(k)$, then (M, γ) has the groomed decomposition extension property with respect to $\gamma \cap N(k)$ if and only if k is isotopic to a curve transverse to the product fibration of $S \times I$.

Proof that Lemma 8.22 implies Corollary 8.19. \Rightarrow Extend the given fibration \mathcal{F} of $S^3 - \dot{N}(k)$ to a fibration on M by attaching discs to the boundary of each fiber of \mathcal{F} .

\Leftarrow Apply Corollaries 8.2 and 8.3 to k and a Seifert surface of minimal genus S' for k to conclude that S' extends to a surface S in M which is punctured once by k and is minimal genus in M . Let \mathcal{F} be the fibration of M with fiber F . S is incompressible and homologous to F so by Neuwirth [15] S is isotopic to a fiber; hence, we can assume that S is a fiber of \mathcal{F} . Since $M - \dot{N}(S) = S \times I$ we can view k as a properly embedded arc in $S \times I$.

We now show that k is a prime arc in $S \times I$. Let Q be a 2-sphere in $S \times I$ such that $|Q \cap k| = 2$ and let B be the unique 3-cell that Q bounds. Let $T \subset B$ be the torus $(Q - \dot{N}(k)) \cup (\partial N(k) \cap B)$. T separates S^3 into two regions, both S^3 knot complements, one of which is $B - \dot{N}(k)$ and the other is $S^3 - \dot{N}(k)$. Since $T \subset S^3$, T bounds a solid torus V . If $V = S^3 - \dot{N}(k)$, then k is the trivial knot and obviously prime. If $V = B - \dot{N}(k)$, then $k \cap B$ can be isotoped in $B \text{ rel } k \cap Q$ to be an embedded arc in Q , so k is prime.

By Example 8.18 and Lemma 8.22, k can be isotoped to be transverse to \mathcal{F} . The desired fibration is obtained by restricting \mathcal{F} to $S^3 - \dot{N}(k)$.

Proof of Lemma 8.22. \Leftarrow This follows from the fact that there is a fibered knot of every genus and Lemma 8.14. Alternatively one could give a completely elementary proof using the fact (compare Figure 3.3) that any decomposition of a product sutured manifold which yields a taut sutured manifold also yields a product sutured manifold.

\Rightarrow If S is a disc, then k is isotopic to a vertical arc since k is prime. To complete the proof we need to show that if $S \neq D^2$ is not closed (resp. closed), then there exists a nonseparating product disc (resp. annulus) A in $S \times I$ such that $A \cap k = \emptyset$. Since the sutured manifold obtained by decomposing (M, γ) along A has the groomed decomposition extension property with respect to $\delta N(k)$, the lemma follows by induction on $\chi(S)$ if $\partial S \neq \emptyset$, and from the $\partial S = \emptyset$ case if S is closed.

Step 1. Show that it suffices to prove Lemma 8.22 under the additional hypothesis “If T is a properly embedded surface in $S \times I$ such that $\partial T \subset (\partial S) \times I$ and $|T \cap k| = 1$, then $T - \dot{N}(k)$ is isotopic in M to either $S \times 1 - \dot{N}(k)$ or $S \times 0 - \dot{N}(k)$.”

Proof. By Haken (see [10]) there exists a maximal set $\mathcal{T} = \{T_1, \dots, T_n\}$ of pairwise disjoint surfaces such that each T_i is properly embedded in S , $\partial T_i \subset (\partial S) \times I$, T_i is isotopic to $S \times 1$, $|T_i \cap k| = 1$, no $T_i - \dot{N}(k)$ is isotopic in M to $S \times 1 - \dot{N}(k)$ or $S \times 0 - \dot{N}(k)$ or $T_j - \dot{N}(k)$ for some $j \neq i$. By [18] or [20] we can isotope k and \mathcal{T} so that \mathcal{T} is a union of fibers of the product fibration of $S \times I$. Orient each T_i so that the + side of T_i faces $S \times 1$. Each component (N, λ) of the sutured manifold (M_1, γ_1) obtained by decomposing (M, γ) along \mathcal{T} is taut and satisfies the groomed decomposition extension property $\text{rel } \partial(N(k)) \cap \lambda$. Since $N = S \times [a, b] - \dot{N}(k)$ for some $a, b \in I$ we conclude that $S \times [a, b]$ and $k \cap S \times [a, b]$ satisfy the hypotheses of Lemma 8.22 together with the additional hypothesis of Step 1. Therefore $k \cap [a, b]$ is isotopic to a vertical arc in $S \times [a, b]$. After isotoping k in a similar manner for each component of M_1 , k will be transverse to the fibration of $S \times I$.

Step 2. Show that for each $z \in H_1(S \times 0, \partial S \times 0)$, there exists a set $\mathcal{A} = \{A_1, \dots, A_n\}$ of oriented annuli and discs in $S \times I$ such that $\mathcal{A} \cap k = \emptyset$, $\mathcal{A} = \lambda \times I$ for λ a union of simple pairwise disjoint curves in $S \times 0$, and $[\mathcal{A}] \cap S \times 0 = z$.

Proof. Let σ be a union of embedded pairwise disjoint curves in $S \times 0 - k$ such that $[\sigma] = z$, no nontrivial subset of σ is homologically trivial in $H_1(S \times 0, \partial S \times 0)$, and if δ is a component of $\partial S \times 0$, then $|\sigma \cap \delta| = \langle \sigma, \delta \rangle$. Let $y' = f^*[\sigma]$ where $f: S \times I \rightarrow S \times 0$ is the natural projection and $f^*: H^1(S \times 0) = H_1(S \times 0, \partial S \times 0) \rightarrow H^1(S \times I) = H_2(S \times I, \partial(S \times I))$. Let T (resp. R) be the surface obtained by applying Lemmas 0.6 and 0.7 of [6] to $y = y' \cap [M, \partial M] \in H_2(M, \partial M)$ (resp. $-y$) so that $\partial T \cap S \times i = \sigma \times I \cap S \times i$ (resp. $\partial R \cap S \times i = \sigma \times I \cap S \times i$) for $i = 0, 1$ as unoriented curves. Attach discs to each component of $\partial T \cap N(k)$ (resp. $\partial R \cap N(k)$) to obtain the properly embedded surface \hat{T} (resp. \hat{R}) in $S \times I$ so that $\hat{T} \cap M = T$ (resp. $\hat{R} \cap M = R$). By isotoping k , \hat{R} and, \hat{T} slightly we can assume that $\partial N(k) \cap (\hat{T} \cap \hat{R}) = \emptyset$.

We now show that topologically \hat{T} (resp. \hat{R}) is isotopic to the surface obtained by doing oriented cut and paste to $\sigma \times I$ (resp. $-\sigma \times I$) and $p \geq 0$ (resp. $q \geq 0$) horizontal surfaces; i.e., surfaces of the form $S \times \text{pt.}$ $p < 0$ means $|p|$ copies of $(-S) \times \text{pt.}$, where $-S$ denotes S oppositely oriented. The incompressibility of \hat{T} (which follows from the groomed decomposition extension property) implies that \hat{T} is obtained by doing oriented cut and paste to $\sigma \times I$ and p horizontal surfaces. To see this first find a set of product annuli

and discs which chop $S \times I$ into $D^2 \times I$'s. Next, isotope $\hat{T} \cap$ (each product surface) to be either vertical or horizontal. Finally, straighten out the components of $\hat{T} \cap$ (each $D^2 \times I$) (compare Step 1 of [5]). Lemma 0.5 of [6] implies that \hat{T} orientedly cut and pasted with one horizontal surface is incompressible, hence we conclude that either $p \geq 0$ or $\chi(S) = 0$. The result for R follows similarly. If $\chi(S) = 0$, then after an isotopy of \hat{R} , \hat{T} , and k we can assume that $p, q \geq 0$.

After an isotopy of T we can assume that T appears on $(\partial S) \times I$ as follows. Let ω be a component of ∂S . If λ is a closed component of $T \cap \omega \times I$, then λ is of the form $\omega \times pt$. If λ is a component of $T \cap \omega \times I$ homeomorphic to I , then the projection of λ to the I factor of $\omega \times I$ is a homeomorphism, and the projection of λ to $\omega \times 0$ is a degree p immersion. The appropriate corresponding statements for R should hold. Furthermore, if one of p or q is nonzero, then T and R should intersect transversely on $(\partial S) \times I$.

Fix $x \in S \times I - (\hat{T} \cup \hat{R})$. Define a function $\varphi : S \times I - (\hat{T} \cup \hat{R}) \rightarrow \mathbb{Z}$ by $\varphi|_{S \times 0} = 0$ and $\varphi(t) = \langle \lambda, R \rangle + \langle \lambda, T \rangle$ where λ is an oriented path from x to t . φ is well defined because $[\hat{T}] = -[\hat{R}] \in H_2(S \times I, \partial(S \times I))$ (compare [3, p. 452]). Thicken and/or squeeze down slightly in a natural way each $\varphi^{-1}(i)$ to obtain J_i (see Figure 8.2 for the 1-dimensional version). Note that the arrows indicate transverse orientation. The union of the J_i 's equals M and $J_i \cap J_r = \emptyset$ if $i \neq r$. Also $J_i \cap J_r \neq \emptyset$ implies that $|i - r| = 1$. By construction $|\hat{T} \cap k| = \langle \hat{T}, k \rangle$ and $|\hat{R} \cap k| = \langle \hat{R}, k \rangle$ (for otherwise decomposing (M, γ) along, say, T would be undefined), so k is a path starting at $S \times 0 \subset J_0$ and passing through J_1, J_2, \dots, J_{p+q} in sequential order before ending at $S \times 1$. Figure 8.2(b) shows the rule for constructing the J_i 's. Figure 8.2(c) shows the J_i 's which would arise from Figure 8.2(a).

Claim. We can assume that each J_i is homeomorphic to $S \times I$.

Proof of Claim. The proof will follow by induction on $|R \cap T|$.

We can assume that the closure of no component of $\hat{R} \cup \hat{T} - (\hat{R} \cap \hat{T})$ is a disc D such that $D \cap (\partial S) \times I = \emptyset$. If such a disc existed (say in \hat{R}), then the incompressibility of \hat{T} would imply that $\partial \bar{D}$ bounds a disc E in \hat{T} . $D \cup E$ bounds a 3-ball B in $S \times I$ and $|E \cap k| = |D \cap k|$. Now replace \hat{T} by $(\hat{T} - E) \cup D$ isotoped slightly in $N(B)$ to reduce $|T \cap R|$.

We can assume that no component W of any J_i has the property that either $\partial W \subset J_{i+1}$ or $\partial W \subset J_{i-1}$. By construction $W \cap (\partial(S \times I) \cup k) = \emptyset$. Let $T^* = (T - (\partial W \cap T)) \cup (-\partial W \cap R)$, and T^* be the natural extension to $S \times I$. \hat{T}^* is homologous to \hat{T} in $H_2(S \times I, \partial(S \times I))$, and the fact that T and R were Thurston norm minimizing as relative classes implies that $\chi(\partial W \cap \hat{T}) = \chi(\partial W \cap \hat{R})$ so $\chi(\hat{T}^*) = \chi(\hat{T})$. The previous paragraph rules out the possibility that some component of T^* is a sphere. Therefore \hat{T}^* is

isotopic to $\hat{T} \text{ rel } \partial \hat{T}$ and decomposing (M, γ) along T yields a taut sutured manifold, so we can continue our discussion with \hat{T} replaced by \hat{T}^* . Note that after a small isotopy $|T^* \cap R| < |T \cap R|$ (see [3, Figure 3.2]).

We now show that each J_i is connected and $|\partial J_i| = 2$. Construct a graph G as follows. The vertices are the components of the J_i 's. Connect J_i to J_r by an oriented edge if $i < r$ and $J_i \cap J_r \neq \emptyset$. The previous paragraph implies that J_0 is the only vertex such that all edges point out and J_{p+q} is the only vertex such that all edges point in. Therefore, if J_i exists, then $0 \leq i \leq p + q$ and $|J_0| = |J_{p+q}| = 1$. If $p + q = 0$, then $J_0 = S \times I$. If $p + q = 1$, then by observing values of φ near points of $R \cap T$ we see that $R \cap T = R \cap T \cap S \times \{0, 1\}$ and our assertion follows. Now assume that $p + q \geq 2$. To complete the proof of our assertion it suffices to show that G is a tree and that $|J_i \cap J_r| \leq 1$ for all i, r , so it is sufficient to show that there exists no loop μ in $S \times I$ which intersects some boundary component W of some J_i exactly once. For homological reasons the existence of such a W implies that $\partial W \cap S \times 1 \neq \emptyset$ and $\partial W \cap S \times 0 \neq \emptyset$ and therefore $p + q \leq 1$, contradicting our assumption that $p + q \geq 2$.

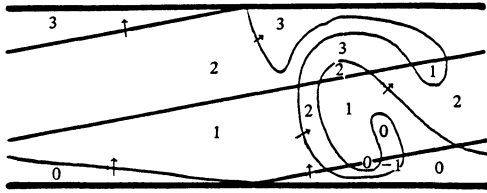

a)

Rule:

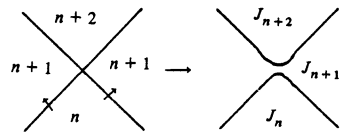

b)

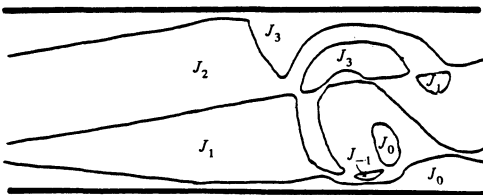

c)

FIGURE 8.2

For $0 \leq i \leq p + q$, define $Y_i = \partial(J_0 \cup J_1 \cup \dots \cup J_i) - S \times 0$. Note that $\partial Y_i \subset (\partial S) \times I$ and is homologous to $S \times 0$ in $H_2(S \times I, (\partial S) \times I)$. Since $\chi(Y_i) \leq \chi(S)$, Y_i is connected, $|\partial Y_i| = |\partial S|$, and $\chi(\cup Y_i\text{'s}) = \chi(\hat{R}) + \chi(\hat{T}) + \chi(S \times 1) - 2\chi(\sigma) = (p + q + 1)\chi(S)$, it follows that each Y_i is homeomorphic to S and incompressible in $S \times I$. By the standard isotopy results we can isotope the Y_i 's to be of the form $S \times \text{pt.}$ q.e.d.

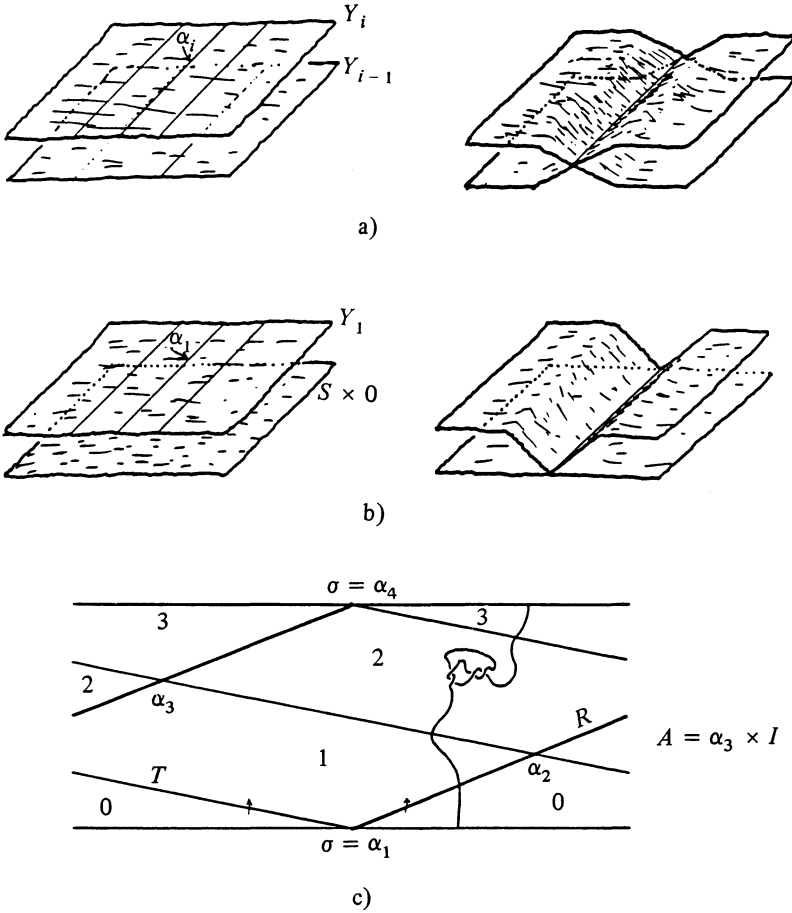

FIGURE 8.3

It follows by Step 1 and the Claim that the following is the exact picture of T and R in $S \times I$. If $p = q = 0$, then $T = R = \sigma \times I$. Otherwise start with surfaces Y_1, Y_2, \dots, Y_{p+q} where each Y_i is a surface in $S \times I$ of the form $S \times a_i$ and $0 < a_1 < \dots < a_{p+q} < 1$. Let $\alpha_1, \alpha_2, \dots, \alpha_{p+q+1}$ be sets of pairwise

disjoint simple curves in S such that $\alpha_1 = \sigma = \alpha_{p+q+1}$. (If $p + q = 1$ then isotope α_1 slightly to be disjoint from σ .) If $i \neq 1, p + q + 1$, then remove $\dot{N}(\alpha_i)$ from Y_i and Y_{i-1} and attach criss-crossing strips to Y_i and Y_{i-1} as in Figure 8.3(a). If $i = 1$ (resp. $p + q + 1$) then remove $\dot{N}(\alpha_1)$ (resp. $\dot{N}(\alpha_{p+q+1})$) from Y_1 (resp. Y_{p+q}) and attach strips between Y_1 (resp. Y_{p+q}) and $S \times 0$ (resp. $S \times 1$) as in Figure 8.3(b). \hat{R} and \hat{T} are the connected components of the surfaces constructed. By Step 1 there exists an i such that k is isotopic to a vertical arc when restricted to J_r (which is isotopic to $S \times I$) for $r \neq i$ and by construction $k \cap \alpha_{i+1} \times I \cap J_i = \emptyset$.

Step 2 now follows from the observations that k can be isotoped off of $\alpha_i \times I$ and that the projection of $\hat{T} \cap (S \times [0, t - \varepsilon])$ (where $Y_i \subset S \times t$) to $S \times 0$ is a homology between α_i and σ . Our desired \mathcal{A} equals $\alpha_i \times I$. q.e.d.

Since the trefoil and the figure 8 knots are the only genus 1 fibered knots [8] we obtain the following result.

Corollary 8.23. *Surgery on a knot k in S^3 yields a torus bundle over S^1 if and only if the surgery is the zero frame one and either k is the trefoil knot or k is the figure 8 knot.*

References

- [1] M. Culler, C. Gordon, J. Luecke & P. Shalen, *Dehn surgery on knots*, Ann. of Math., to appear.
- [2] W. Floyd & U. Oertel, *Incompressible surfaces via branched surfaces*, Topology **23** (1984) 117–125.
- [3] D. Gabai, *Foliations and the topology of 3-manifolds*, J. Differential Geometry **18** (1983) 445–503.
- [4] ———, *Foliations and genera of links*, Topology **23** (1984) 381–394.
- [5] ———, *The simple loop conjecture*, J. Differential Geometry **21** (1985) 143–149.
- [6] ———, *Foliations and the topology of 3-manifolds. II*, J. Differential Geometry **26** (1987) 461–478.
- [7] ———, *Surgery on knots in solid tori*, in preparation.
- [8] F. Gonzales-Acuña, *Dehn's construction on knots*, Bol. Soc. Mat. Mexicana **15** (1970) 58–79.
- [9] J. Hempel, *3-manifolds*, Annals of Math. Studies, Vol. 86, Princeton University Press, Princeton, NJ, 1976.
- [10] W. H. Jaco, *Lectures on three-manifold topology*, Regional Conf. Ser. in Math., No. 43, Amer. Math. Soc., Providence, RI, 1980.
- [11] W. Jaco & P. Shalen, *Seifert fibered spaces in 3-manifolds*, Mem. Amer. Math. Soc., No. 220 (1979).
- [12] K. Johannson, *Homotopy equivalences of 3-manifolds with boundary*, Lecture Notes in Math., Vol. 761, Springer, Berlin, 1979.
- [13] R. Kirby, *Problems in low dimensional manifold theory*, Proc. Sympos. Pure Math., Vol. 32, Amer. Math. Soc., Providence, RI, 1978, 273–312.
- [14] R. Litherland, *Surgery on knots in solid tori. II*, J. London Math. Soc. (2) **22** (1980) 559–569.
- [15] L. Neuwirth, *Knot groups*, Annals of Math. Studies, Vol. 56, Princeton University Press, Princeton, NJ, 1965.

- [16] S. P. Novikov, *Topology of foliations*, Trans. Moscow Math. Soc. **14** (1963) 268–305.
- [17] V. Poenaru, personal communication.
- [18] R. Roussarie, *Plongements dans les variétés feuilletées et classification de feuilletages sans holonomie*, Inst. Hautes Études Sci. Publ. Math. **443** (1973) 101–142.
- [19] M. Scharlemann, *Tunnel number one knots satisfy the Poenaru conjecture*, Topology Appl. **18** (1984) 235–258.
- [20] W. P. Thurston, *Foliations of manifolds which are circle bundles*, Thesis, University of California, Berkeley, 1972.
- [21] ———, *Three dimensional manifolds, Kleinian groups and hyperbolic geometry*, Proc. Sympos. Pure Math., Vol. 27, Amer. Math. Soc., Providence, RI, 1975, 315–319.
- [22] ———, *A norm for the homology of three-manifolds*, Mem. Amer. Math. Soc., Vol. 59, No. 339, 1986.

CALIFORNIA INSTITUTE OF TECHNOLOGY