

A COMPLETE SYSTEM OF GRAMMARS FOR PLANE GRAPHS

By
Tadahiro UESU

Introduction

In [1], for directed graphs, it was shown that the system of simple graph grammars is complete. In this paper, a system of grammars for plane graphs¹, called plane graph grammars, is introduced, and it is shown that this system is complete, i.e. the following theorem holds:

THEOREM. *For each alphabet T , the class of all sets of labelled plane graphs over T defined by plane graph grammars identical with the class of all recursively enumerable sets² of labelled plane graphs over T .*

A *production* of our system is an ordered pair (K_1, K_2) , where each K_i ($i=1, 2$) is a partially labelled plane graph in a shape of a wheel such that its hub is a labelled plane graph, its spokes are unlabelled edges and its rim is an unlabelled cycle, and K_1 and K_2 have the same rim. An illustration of a production is shown in Figure 0.1.

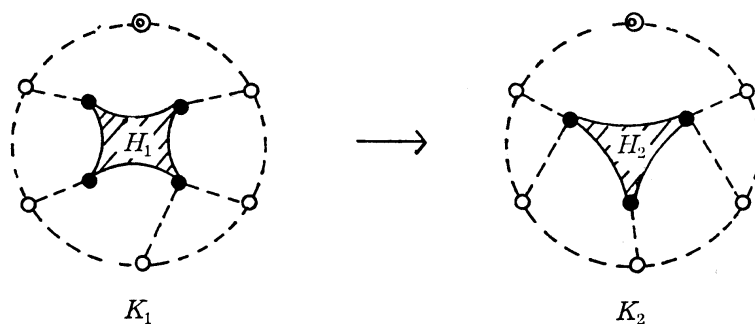

Fig. 0.1. Production (K_1, K_2) . H_1 and H_2 are the hubs of K_1 and K_2 respectively. For each K_i ($i=1, 2$), dotted circle represents the rim, dotted straight lines represent spokes, and small double circle denotes the origin of the rim.

Received September 6, 1978. Revised February 6, 1979

¹ Intuitively speaking, a plane graph is a graph on a plane in which no two edges intersect. We are concerned with plane graphs in which loops and multiple edges are permitted.

² A set of plane graphs is recursively enumerable if, by a Gödel numbering, the set of Gödel numbers of plane graphs in it is recursively enumerable.

The notion of *direct derivation* of our system is defined in the following manner: Let (K_1, K_2) be a production as shown in Figure 0.1, H_i the hub of K_i , and G_i a labelled plane graph in which H_i occurs as shown in Figure 0.2 for $i=1, 2$. G_2 is said to be *directly derived* from G_1 according to (K_1, K_2) if there exists a partially labelled plane graph S , as shown in Figure 0.2, with the same unlabelled cycle as the rim of K_1 such that G_i ($i=1, 2$) results from first embedding K_i into the inside of the cycle of S so that the rim of K_i may fit on the cycle of S , then contracting all spokes of K_i to their labelled ends and erasing the rest of the rim.

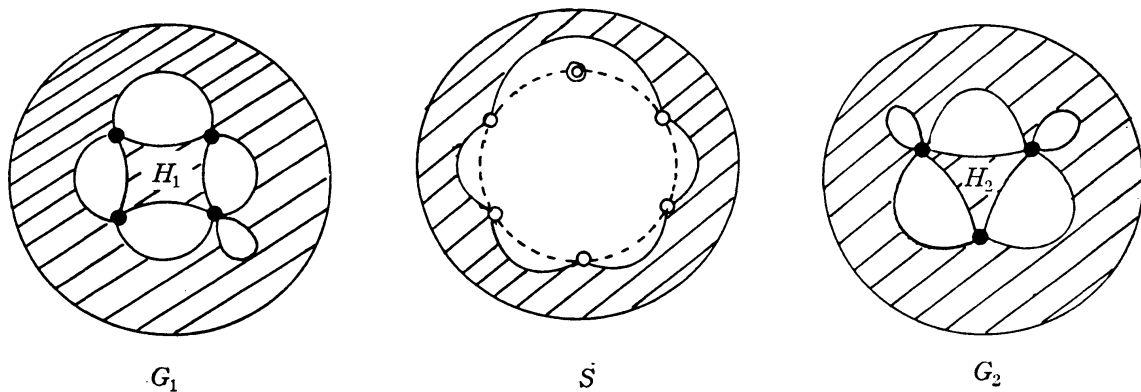
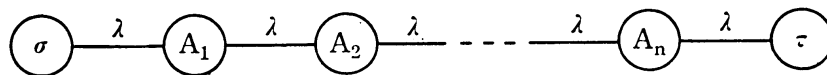

Fig. 0.2. G_2 is directly derived from G_1 according to (K_1, K_2) in Figure 0.1. The unlabelled cycle of S is the same as the rim of K_1 .

The outline of the proof of Theorem is this: Let R be a recursively enumerable set of labelled plane graphs over an alphabet T . We give an effective coding from the labelled plane graphs over T into the finite strings over some alphabet. Then the set R_0 of all the strings which correspond to elements in R is recursively enumerable. For each finite string $A_1A_2\cdots A_n$ of symbols, a plane graph, called a plane-graph-expression of the string, of the form



is given. Then, by the same way as [1], it is verified that the set R_1 of all the plane-graph-expressions of strings in R_0 is defined by a plane graph grammar G_0 . We furthermore give a finite set P of productions such that for each labelled plane graph H in R and for the corresponding plane graph H_1 to H in R_1 , H is derived from H_1 according to the set P of productions, and no other labelled plane graph

over T may be derived from H_i according to P . It is then verified that the plane graph grammar which results from connecting G_0 with P defines the set R .

In [2] and [3], they were concerned with the study of grammars for plane simple graphs³ and introduced the notion of a cut-curve. Our notion of a rim with spokes may be considered as an extension of their notion of a cut-curve.

In the first section of this paper, the formal definition of plane graphs is given. In the second section, the definition of labelled plane graphs and several concepts concerned with labelled plane graphs are given. In the third section, the formal definition of plane graph grammars is given. In the last two sections, the precise proof of Theorem is given. And in Appendix, it is also shown that the system of canonical plane graph grammars is complete, where the notion of a canonical plane graph grammar is an analogue of the notion of a simple graph grammar in [1]: A plane graph grammar is said to be canonical if for each production (K_1, K_2) of it, no two spokes in K_i ($i=1, 2$) have an end in common.

1. Plane Graphs

A *graph* is an ordered triple (V, E, Ψ) consisting of two disjoint sets V, E and a function Ψ from E to the set of unordered pairs of (not necessarily distinct) elements of V . V, E and Ψ are respectively called the set of *vertices*, the set of *edges* and the *incidence function* of G . If e is an edge and v is a vertex in $\Psi(e)$, then the vertex v is called an *end* of e . An edge with a single end is called a *loop*, and an edge with distinct ends a *link*. The ends of an edge are said to be *incident* with the edge, and vice versa. A vertex which is incident with no edge is called an *isolated* vertex. If e is an edge, and if u and v are the ends of e , then the sequence uev is called a *step*. A *walk* is a finite sequence of the form $v_0e_1v_1e_2v_2\cdots e_kv_k$ where $1 \leq k$, e_i is an edge and the ends of e_i are v_{i-1} and v_i for each i ($i=1, 2, \dots, k$). The vertices v_0 and v_k are called the *origin* and the *terminus* of the walk respectively, and v_1, v_2, \dots, v_{k-1} its *internal* vertices. A walk in which vertices occurring at distinct places are distinct is called a *path*. A walk whose origin and terminus are the same is said to be *closed*. A closed walk in which any internal vertex does not occur twice is called a *cycle*. A *connected* graph is a graph that contains a walk with the origin u and the terminus v for each pair u, v of distinct vertices.

Intuitively speaking, a plane graph is a diagram on the plane which consists of finite points and finite arcs joining certain pairs of these points such that no

³ A plane graph is a plane simple graph if it has no loops and no two of its edges join the same pair of vertices.

two arcs cross one another. We call such a diagram an *intuitive plane graph*.

An intuitive plane graph partitions the plane into finite regions. Each region is called a *face* of the intuitive plane graph. Note that, for each intuitive plane graph, there is exactly one unbounded face. We call the unbounded face the *exterior face*. For example, the face F_1 in Figure 1.1 is the exterior face.

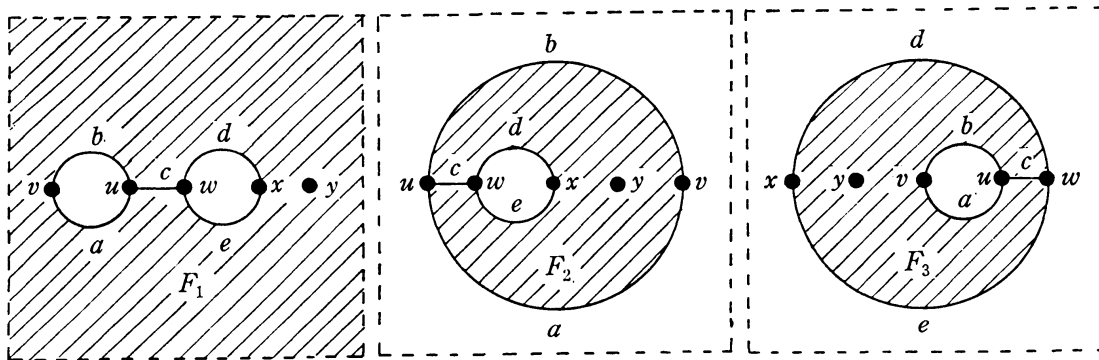

Fig. 1.1

The boundary of a face consists of finite connected components. For each connected component which is not a single point, we have a closed walk in the following manner: For the face F_1 in Figure 1.1, for example, the closed walk $uavbucwdxewcu$ may be obtained, if we trace along the connected component not the point y of the boundary from right to left, as seen from the inside of the face F_1 . Such a closed walk has the following property:

PROPERTY P. *Steps occurring at distinct places in the walk distinct and, for each pair u, v of distinct vertices in the walk there exists a unique path P with the origin u and the terminus v such that each step in P occurs in the walk.*

For the above example, the unique path from w to v is $wcuav$.

DEFINITION 1.1. Let G be a graph. A closed walk in G is a *boundary walk* in G if it has the Property P.

DEFINITION 1.2. Let G be a graph. A *quasiboundary* in G is a finite set consisting of isolated vertices and boundary walks in G such that any pair of its boundary walks has no vertex in common.

Let G be the graph

$$(\{u, v, w, x, y\}, \{a, b, c, d, e\}, \Psi),$$

where $\Psi(a) = \Psi(b) = \{u, v\}$, $\Psi(c) = \{u, w\}$, $\Psi(d) = \Psi(e) = \{w, x\}$. Each intuitive plane graphs

in Figure 1.1 represents the graph G . The boundary of the face F_1 represents the quasiboundary $\{y, uavbucwd, xewcu\}$, and also each boundary of the faces F_2 and F_3 represents the same quasiboundary. So a quasiboundary does not necessarily correspond to a unique face. But when the exterior face is indicated, a quasiboundary corresponds to a unique face. Then we have the formal definition of plane graphs:

DEFINITION 1.3. A *plane graph* is an ordered triple (G, B_0, \mathbf{B}) consisting of a graph G , a quasiboundary B_0 in G and a finite set \mathbf{B} of quasiboundaries in G with the following properties.

- (1) $B_0 \in \mathbf{B}$.
- (2) If B and B' are distinct elements of \mathbf{B} , then there is a finite sequence B_1, \dots, B_m of elements of \mathbf{B} such that B_1 is B , B_m is B' and each B_i ($i=2, 3, \dots, m$) has an edge in common with B_{i-1} .
- (3) If v is an isolated vertex of G , then there exists one and only one B in \mathbf{B} such that $v \in B$.
- (4) If e is a loop of G and u is the end of e , then there exist precisely two elements of \mathbf{B} such that each of them contains a boundary walk in which the step ueu occurs.
- (5) If e is a link of G , and if u and v are the ends of e , then there exists one and only one element of \mathbf{B} containing a boundary walk in which the step uev occurs.

In the above definition, the quasiboundary B_0 denotes the boundary of the exterior face. It is easily checked that each formal plane graph denotes a unique intuitive plane graph, and that for each intuitive plane graph there is a formal plane graph which denotes the intuitive plane graph.

EXAMPLE 1.1. Let

$$B_0 = \{zaz\}, \quad B_1 = \{sctbs\}, \quad B_2 = \{ufveu\}, \quad B_3 = \{zaz, w, xgygx, sbtduevfudtcs\},$$

and

$$\mathbf{B} = \{B_0, B_1, B_2, B_3\}.$$

And let G be the graph which is naturally determined by \mathbf{B} . Then the ordered triple (G, B_0, \mathbf{B}) is a plane graph and the corresponding digram is as shown in Figure 1.2.

For a plane graph (G, B_0, \mathbf{B}) , \mathbf{B} is called the set of its *boundaries* and B_0 is called the *exterior boundary* of it. When $G = (V, E, \Psi)$ and $\mathbf{B} = \{B_0, B_1, \dots, B_n\}$ we write the plane graph (G, B_0, \mathbf{B}) in displayed form as

$$(V, E, \Psi, B_0, B_1, \dots, B_n).$$

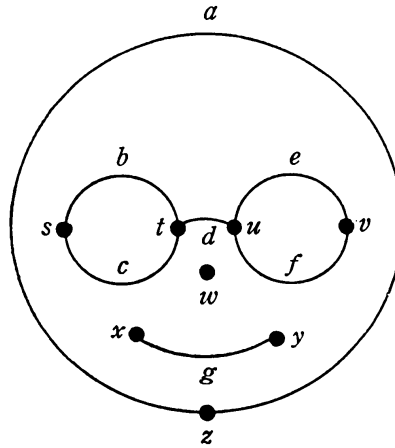

Fig. 1.2

DEFINITION 1.4. For a boundary walk $v_0e_1v_1e_2v_2\cdots e_kv_k$, each boundary walk of the form $v_{i-1}e_iv_ie_{i+1}e_{i+1}\cdots e_kv_ke_1v_1\cdots e_{i-1}v_{i-1}$ ($i=1, 2, \dots, k$) is said to be *homologous* to the boundary walk $v_0e_1v_1e_2v_2\cdots e_kv_k$. Two quasiboundaries B and B' in a graph are said to be *homologous* if for each element X in B , there exists an element in B' which is identical or homologous to X , and vice versa. Two sets \mathbf{B} and \mathbf{B}' of quasiboundaries in a graph are said to be *homologous* if for each element B in \mathbf{B} , there is an element in \mathbf{B}' which is homologous to B , and vice versa. Two plane graphs (G, B_0, \mathbf{B}) and (G', B_0', \mathbf{B}') are said to be *homologous* if G and G' are identical, B_0 and B_0' are homologous, and \mathbf{B} and \mathbf{B}' are homologous.

Two graphs (V, E, Ψ) and (V', E', Ψ') are said to be *isomorphic* if there is a one-to-one function ϕ from $V \cup E$ onto $V' \cup E'$ such that $e \in E$ if and only if $\phi(e) \in E'$, and $v \in \Psi(e)$ if and only if $\phi(v) \in \Psi'(\phi(e))$; such function ϕ is called an *isomorphism* between (V, E, Ψ) and (V', E', Ψ') . Given an isomorphism ϕ between graphs G and G' we extend it to walks by the following recursive definition: For any walk W in G , if $\phi(W)$ have already been defined, then

$$\phi(Wev) = \phi(W)\phi(e)\phi(v).$$

We, in addition, extend it to quasiboundaries and sets of quasiboundaries by the following manner: For any quasiboundary B in G , $X \in B$ if and only if $\phi(X) \in \phi(B)$; for any set \mathbf{B} of quasiboundaries in G , $B \in \mathbf{B}$ if and only if $\phi(B) \in \phi(\mathbf{B})$.

DEFINITION 1.5. Two plane graphs (G, B_0, \mathbf{B}) and (G', B_0', \mathbf{B}') are said to be *isomorphic* if there is an isomorphism ϕ between the graphs G and G' such that $\phi(B_0)$ is homologous to B_0' and $\phi(\mathbf{B})$ is homologous to \mathbf{B}' ; such ϕ is called an *isomorphism* between plane graphs (G, B_0, \mathbf{B}) and (G', B_0', \mathbf{B}') .

A *plane subgraph* of a given plane graph is obtained by erasing edges or vertices off the plane graph. The formal definition is recursively given as follows:

DEFINITION 1.6. Let P be a plane graph.

(1) A homologous plane graph to P is a plane subgraph of P .

(2) If $(V, E, \Psi, B_0, B_1, \dots, B_n)$ is a plane subgraph of P , v is an isolated vertex of it and $v \in B_i$ ($0 \leq i \leq n$), then a homologous plane graph to the plane graph

$$(V - \{v\}, E, \Psi, B_0, B_1, \dots, B_{i-1}, B_i - \{v\}, B_{i+1}, \dots, B_n)$$

is a plane subgraph of P .

(3) If $(V, E, \Psi, B_0, B_1, \dots, B_n)$ is a plane subgraph of P , e is a link with ends u, v , and W is a boundary walk in B_i ($0 \leq i \leq n$) which is homologous to the walk of the form ueV_1eV_2 , then a homologous plane graph to the plane graph

$$(V, E - \{e\}, \Psi - \{(e, \{u, v\})\}^4, B_0, B_1, \dots, B_{i-1}, (B_i - \{W\}) \cup \{V_1, V_2\}, B_{i+1}, \dots, B_n)$$

is a plane subgraph of P .

(4) If $(V, E, \Psi, B_0, B_1, \dots, B_n)$ is a plane subgraph of P , e is an edge with (not necessarily distinct) ends u, v , W_1 is a boundary walk in B_i ($0 \leq i < n$) which is homologous to the walk of the form X_1ev , and W_2 is a boundary walk in B_j ($i < j \leq n$) which is homologous to the walk of the form $veuX_2$, then a homologous plane graph to the plane graph

$$(V, E - \{e\}, \Psi - \{(e, \{u, v\})\}, B_0, B_1, \dots, B_{i-1}, (B_i \cup B_j - \{W_1, W_2\}) \cup \{X_1X_2\}, B_{i+1}, \dots, B_{j-1}, B_{j+1}, \dots, B_n)$$

is a plane subgraph of P .

(5) The only plane subgraphs of P are those given by (1)-(4).

Consider the plane graph P as shown in Figure 1.3. Contract the link l to one point. Then the plane graph P' is obtained.

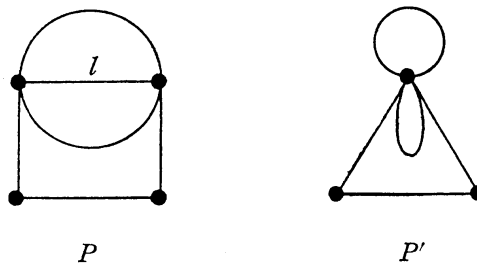

Fig. 1.3. Contraction of link l .

⁴ A function is a subset of the direct product of the domain and the range.

The notion of contraction of links is defined as follows:

DEFINITION 1.7. Let P be a plane graph $(V, E, \Psi, B_0, B_1, \dots, B_n)$, and l a link with ends u, v . Let Ψ' be the incidence function of the graph $(V - \{v\}, E - \{l\}, \Psi')$ such that for each edge e in $E - \{l\}$, $\Psi'(e)$ is the set obtained by replacing v in $\Psi(e)$ by u if $\Psi(e)$ contains v , $\Psi(e)$ otherwise. For each boundary B_i of P and for each element X in B_i , let X' be the sequence which result from first replacing all of the occurrences of v in X by u , then removing all of the occurrences of the sequence ul , and set $B_i' = \{X' \mid X \in B_i\}$. Then $(V - \{v\}, E - \{l\}, \Psi', B_0', B_1', \dots, B_n')$ is the *reduct* of P by contracting l to u . P' is the *reduct* of P by contracting l_1, l_2, \dots, l_m to u_1, u_2, \dots, u_m if there exists a sequence $P_0, P_1, P_2, \dots, P_m$ such that P_0 is P , P_m is P' and P_i is the reduct of P_{i-1} by contracting l_i to u_i for $i=1, 2, \dots, m$.

PROPOSITION 1.1. *For each plane graph, each reduct of it is a plane graph.*

2. Labelled Plane Graphs

DEFINITION 2.1. A *partially labelled plane graph* is an ordered pair (P, λ) consisting of a plane graph P and a function λ whose domain is a set of vertices and edges of P . A *labelled plane graph* is a partially labelled plane graph (P, λ) such that the domain of λ is the set of all vertices and all edges of P .

Let (P, λ) be a partially labelled plane graph. If the range of λ is a subset of an alphabet T , then (P, λ) is said to be *over* T . An edge or a vertex of (P, λ) is said to be *labelled* if it is contained in the domain of λ , *unlabelled* otherwise. The value $\lambda(x)$ is called the *label* of x for each element x of the domain of λ . If (P, λ) is over T and f is a one-to-one function from T , then the partially labelled plane graph $(P, f \circ \lambda)$ is *relabelled* from (P, λ) according to f . If P' is the plane subgraph of P such that the set of vertices and edges of P' is the domain of λ , then the labelled plane graph (P', λ) is called the *labelled part* of (P, λ) .

DEFINITION 2.2. Two labelled plane graphs (P, λ) and (P', λ') are said to be *isomorphic* if there is an isomorphism ϕ between the plane graphs P and P' such that λ is the composition of ϕ and λ' , i.e. $\lambda = \lambda' \circ \phi$.

DEFINITION 2.3. A partially labelled plane graph is a *rimmed kernel* if the following conditions are satisfied:

(1) The exterior boundary has a single element called the *rim*, and the rim is a cycle.

(2) The origin of the rim is incident with no edge which does not occur in the rim.

(3) For each internal vertex v of the rim, there exists one and only one edge called a *spoke* which is incident with v and does not occur in the rim. Each spoke is also incident with a vertex not of the rim.

(4) The unlabelled vertices are the vertices of the rim.

(5) The unlabelled edges are the edges of the rim and the spokes.

A partially labelled plane graph is a *canonical rimmed kernel* if, in addition, the following condition is satisfied:

(6) Distinct spokes have distinct ends.

The labelled part of a rimmed kernel is called the *hub* of the rimmed kernel.

Examples of rimmed kernels are shown in Figure 2.1.

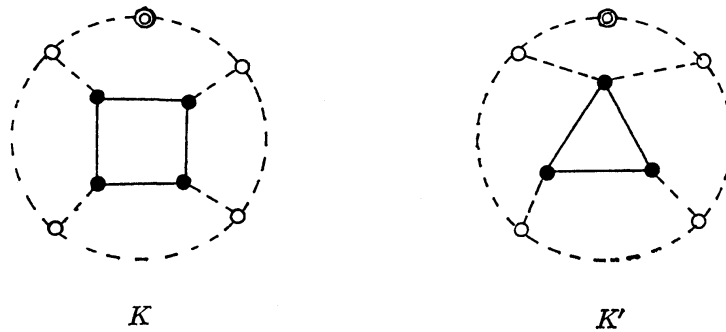

Fig. 2.1. Examples of rimmed kernels. K is a canonical rimmed kernel. K' is not canonical. Here, dotted circles represent rims, dotted straight lines represent spokes, and small double circles represent the origins of rims.

DEFINITION 2.4. A partially labelled plane graph is a *shell* if the following conditions are satisfied:

(1) There exists one and only one boundary which is not exterior and con-

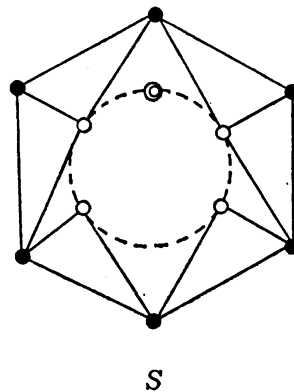

Fig. 2.2. An example of a shell. Dotted circle denotes the rim. Small double circle denotes the origin of the rim.

sists of a single cycle called the *rim* whose vertices and edges are unlabelled.

(2) The origin of the rim is incident with no edge which does not occur in the rim.

(3) The vertices and the edges which do not occur in the rim are labelled.

An example of a shell is shown in Figure 2.2.

DEFINITION 2.5. Let K and S be a rimmed kernel

$$((V^K, E^K, \psi^K, B_0^K, B_1^K, \dots, B_m^K), \lambda^K),$$

and a shell

$$((V^S, E^S, \psi^S, B_0^S, B_1^S, \dots, B_n^S, B_{n+1}^S), \lambda^S),$$

respectively, such that

$$V^K \cap V^S = \{v_1, v_2, \dots, v_k\}, \quad E^K \cap E^S = \{e_1, e_2, \dots, e_k\},$$

$v_k e_1 v_1 e_2 v_2 \dots v_{k-1} e_k v_k$ is the rim of K , $v_k e_k v_{k-1} \dots v_2 e_2 v_1 e_1 v_k$ is the rim of S , and the rim of S is the element of B_{n+1}^S . Let P be the reduct of the plane graph

$$(V^K \cup V^S, E^K \cup E^S, \psi^K \cup \psi^S, B_0^S, B_1^S, \dots, B_n^S, B_1^K \dots, B_m^K)$$

by contracting all the spokes of K to their labelled ends. If a labelled plane graph H is isomorphic to the labelled part of $(P, \lambda^K \cup \lambda^S)$, then the ordered pair (K, S) is called a *partition* of H .

EXAMPLE 2.1. Let K and K' be the rimmed kernels as shown in Figure 2.1, and S the shell as shown in Figure 2.2. Then (K, S) and (K', S) respectively are the partitions of the labelled plane graphs H and H' which are shown in Figure 2.3.

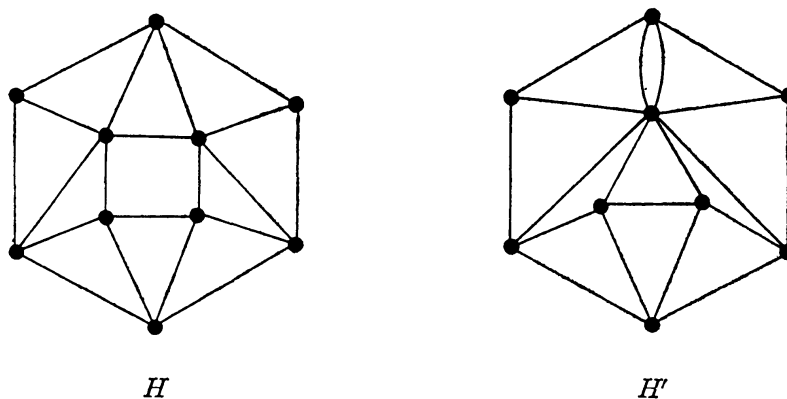

Fig. 2.3

3. Plane graph grammars

DEFINITION 3.1. A *production* is an ordered pair of rimmed kernels with the same rim. For a production (K, K') , K and K' are respectively called the *left kernel* and the *right kernel* of (K, K') . The production (K', K) is called the *inverse production* of (K, K') . A production is said to be *canonical* if its kernels are canonical.

EXAMPLE 3.1. Let K and K' be the rimmed kernels as shown in Figure 3.1. Then (K, K') is a production, and not canonical.

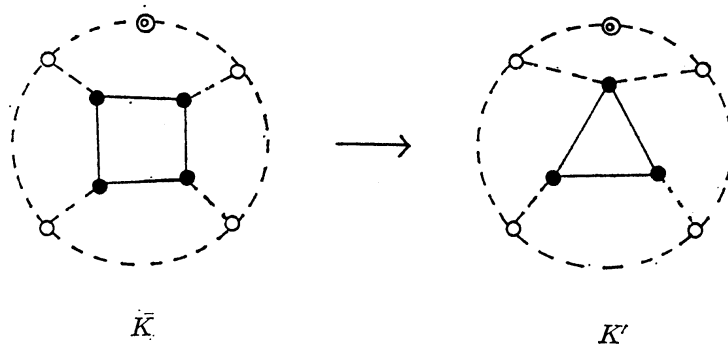

Fig. 3.1. An example of a production.

DEFINITION 3.2. A labelled plane graph H' is *directly derived* from a labelled plane graph H according to a production (K, K') if there exists a shell S such that (K, S) and (K', S) are partitions of H and H' respectively. A labelled plane graph G is *derived* from a labelled plane graph H according to a set P of productions if there exists a finite sequence H_0, H_1, \dots, H_n of labelled plane graphs such that H_0 is H , H_n is G and H_{i+1} is directly derived from H_i according to some production in P for $i=0, 1, \dots, n-1$.

For example, H' in Example 2.1 is directly derived from H in Example 2.1 according to the production (K, K') in Example 3.1.

DEFINITION 3.3. A *plane graph grammar* over an alphabet T is an ordered triple (T, I, P) in which I is a labelled plane graph and P is a finite set of productions. A plane graph grammar (T, I, P) is said to be *canonical* if P is a finite set of canonical productions.

In the following, we identify isomorphic labelled plane graphs.

DEFINITION 3.4. If G is a plane graph grammar (T, I, P) , then the set of all the labelled plane graphs over T that are derived from I according to P is called

the *plane graph language* defined by G .

For each string $A_1A_2\cdots A_n$ over an alphabet T , the labelled plane graph

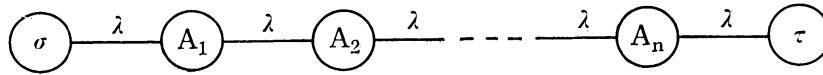

is called the *plane-graph-expression* with auxiliary labels σ, λ, τ of the string.

PROPOSITION 3.1. *Let T be an alphabet and let σ, λ and τ be labels not in T . For each recursively enumerable set R of strings over T , there exists a canonical plane graph grammar G such that the plane graph language defined by G consists of all the plane-graph-expressions with auxiliary labels σ, λ, τ of strings in R .*

Proof is obtained by the same way as Proposition 2.1 in [1].

PROPOSITION 3.2. *Let R be a plane graph language defined by a (canonical) plane graph grammar, P a finite set of (canonical) productions and Σ an alphabet. Then there is a (canonical) plane graph grammar which defines the set of all the labelled plane graphs over Σ that are derived from the elements in R according to P .*

PROOF. Let T be the alphabet consisting of all the labels occurring in the elements of R , and T^* the alphabet consisting of all the labels occurring in the productions of P . Let T' be an alphabet disjoint with $T \cup T^* \cup \Sigma$, and f a one-to-one function from T to T' . Then there is a (canonical) plane graph grammar (T', I, P') which defines the set of all the relabelled plane graphs from elements in R according to f . We may assume that the labels occurring in the productions of P' are not in $T \cup T^* \cup \Sigma$. Let P'' be the set of productions as shown in Figure 3.2. Then the (canonical) plane graph grammar $(\Sigma, I, P' \cup P'' \cup P)$ defines the set of all the labelled plane graphs over Σ that are derived from the elements in R according to P . This completes the proof.

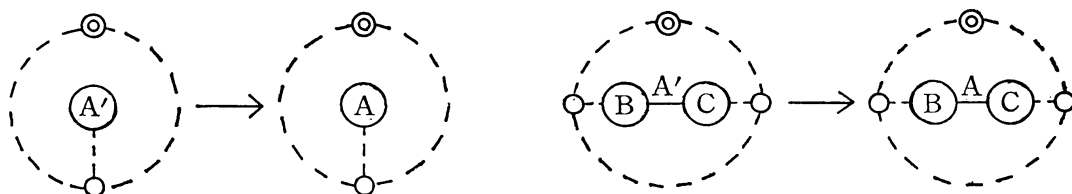

Fig. 3.2. The productions in P'' . A, B and C are labels from T . A' denotes $f(A)$.

4. The completeness of the system of plane graph grammars

We are now going to show that the system of plane graph grammars is complete. We begin with the notion of a Δ -map which is a labelled plane graph in a shape of a triangulation of a polygon:

DEFINITION 4.1. A labelled plane graph is a Δ -map if either it is the empty graph or each boundary of it consists of a single cycle and the cycle of each boundary other than the exterior boundary has exactly three vertices.

DEFINITION 4.1. Let T be an alphabet, and Π and Λ labels not in T . And let $P_{T, \Pi, \Lambda}$ be the set of productions as shown in Figure 4.1. A Δ -map D over $T \cup \{\Pi, \Lambda\}$ is a Δ -expression with auxiliary labels Π, Λ of a labelled plane graph G over T if D is derived from G according to $P_{T, \Pi, \Lambda}$.

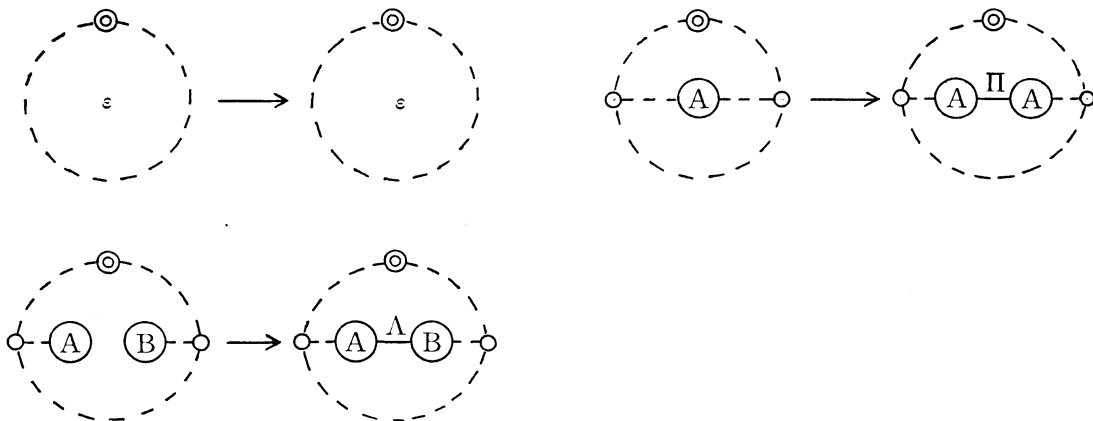

Fig. 4.1. The productions in $P_{T, \Pi, \Lambda}$. A and B are labels from T . ϵ denotes the empty graph.

EXAMPLE 4.1. In Figure 4.2, D is a Δ -expression of G .

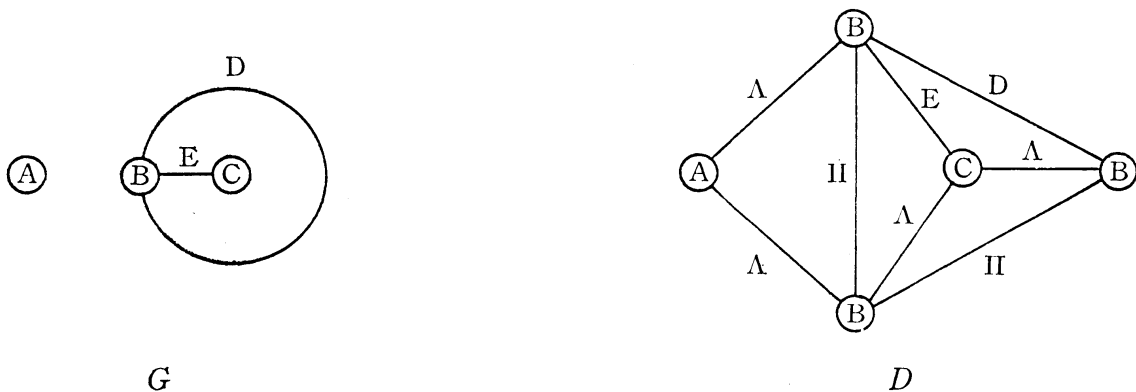

Fig. 4.2. An example of a Δ -expression of a labelled plane graph.

The following proposition is trivial:

PROPOSITION 4.1. *Let T be an alphabet, and Π and Λ labels not in T . If R is a recursively enumerable set of labelled plane graphs over T , then the set of all \mathcal{J} -expressions with auxiliary labels Π, Λ of elements in R is recursively enumerable.*

In order to prove Theorem, we need to use the following lemma, whose proof is given in the next section.

LEMMA. *If R is a recursively enumerable set of Δ -maps over an alphabet, then there exists a plane graph grammar which defines R .*

Now, we prove Theorem:

PROOF OF THEOREM. It is clear that a plane graph language defined by a plane graph grammar is recursively enumerable. Let R be a recursively enumerable set of labelled plane graphs over T , and let Π and Λ be labels not in T . Then, by Proposition 4.1, the set R' of all \mathcal{J} -expressions with auxiliary labels Π, Λ of elements in R is recursively enumerable. Therefore, by Lemma, there exists a plane graph grammar which defines R' . Let P be the set of all inverse productions of elements in the set $P_{T, \Pi, \Lambda}$ of productions. Then, R is the set of all the labelled plane graphs over T that are derived from the elements in R' according to P . Therefore, by virtue of Proposition 3.2, R is defined by a plane graph grammar. This completes the proof.

5. Proof of Lemma

We assume that each edge is a positive integer. Let Σ and Σ_1 be disjoint alphabets, $|$ and $*$ labels not in $\Sigma \cup \Sigma_1$ and f_1 one-to-one correspondence from Σ to Σ_1 , and let those $\Sigma, \Sigma_1, |, *$, and f_1 be fixed for the following discussion. For each element A in Σ , let A^1 denote $f_1(A)$.

DEFINITION 5.1. Let D be a \mathcal{J} -map over Σ . For each edge i of D , let i be i if i does not occur in the exterior boundary, 0 otherwise. If $v_{13}i_{11}v_{11}i_{12}v_{12}i_{13}v_{13}, v_{23}i_{21}v_{21}i_{22}v_{22}i_{23}v_{23}, \dots, v_{n3}i_{n1}v_{n1}i_{n2}v_{n2}i_{n3}v_{n3}$ is a sequence without repetition of all the cycles in the boundaries other than the exterior boundary of D , and if the label of v_{jk} is A_{jk} and the label of i_{jk} is B_{jk} for $j=1, 2, \dots, n; k=1, 2, 3$, then the string

$$\begin{aligned}
 & A_{i_{13}}^1 B_{i_{11}} | \dots | A_{i_{11}}^1 B_{i_{12}} | \dots | A_{i_{12}}^1 B_{i_{13}} | \dots | * A_{i_{23}}^1 B_{i_{21}} | \dots | A_{i_{21}}^1 B_{i_{22}} | \dots | A_{i_{22}}^1 B_{i_{23}} | \dots | * \\
 & \dots * A_{i_{n3}}^1 B_{i_{n1}} | \dots | A_{i_{n1}}^1 B_{i_{n2}} | \dots | A_{i_{n2}}^1 B_{i_{n3}} | \dots | *
 \end{aligned}$$

is called a *string-expression* of D . If D is the empty graph, then its *string-expression* is the empty string. A labelled plane graph H is called a *linear-plane-graph-expression* with auxiliary labels σ, λ, τ of D if there exists a string-expression of D whose plane-graph-expression with auxiliary labels σ, λ, τ is H .

The following proposition is obtained by Definition 5.1 and Proposition 3.1:

PROPOSITION 5.1. *If R is a recursively enumerable set of Δ -maps over Σ , then the set of all the string-expression of Δ -maps in R is recursively enumerable, so that the set of all the linear-plane-graph-expressions with auxiliary labels σ, λ, τ of Δ -maps in R is defined by a canonical plane graph grammar.*

In order to prove Lemma, we provide the following sublemma:

SUBLEMMA. *Let σ, λ and τ be labels not in Σ . Then there exists a finite set P of productions such that for each Δ -map D over Σ and for each linear-plane-graph-expression H with auxiliary labels σ, λ, τ of D , D is the unique labelled plane graph over Σ derived from H according to P .*

PROOF. Let Σ_2 and Σ_3 be alphabets such that $\Sigma, \Sigma_1, \Sigma_2, \Sigma_3$ and $\{ |, *, \sigma, \lambda, \tau \}$ are mutually disjoint, and let f_2 and f_3 be one-to-one correspondences from Σ to Σ_2 and Σ_3 respectively. For each element A in Σ , let A^i denote $f_i(A)$ for $i=2, 3$. Let P_1, P_2 and P_3 be the sets of productions as follows:

STIPULATION: $A, B, C, D, E, F \in \Sigma$. $X \in \Sigma \cup \Sigma_2$. $Y \in \Sigma \cup \{ | \}$. $i=2, 3$.

The lines without label denote edges with label λ .

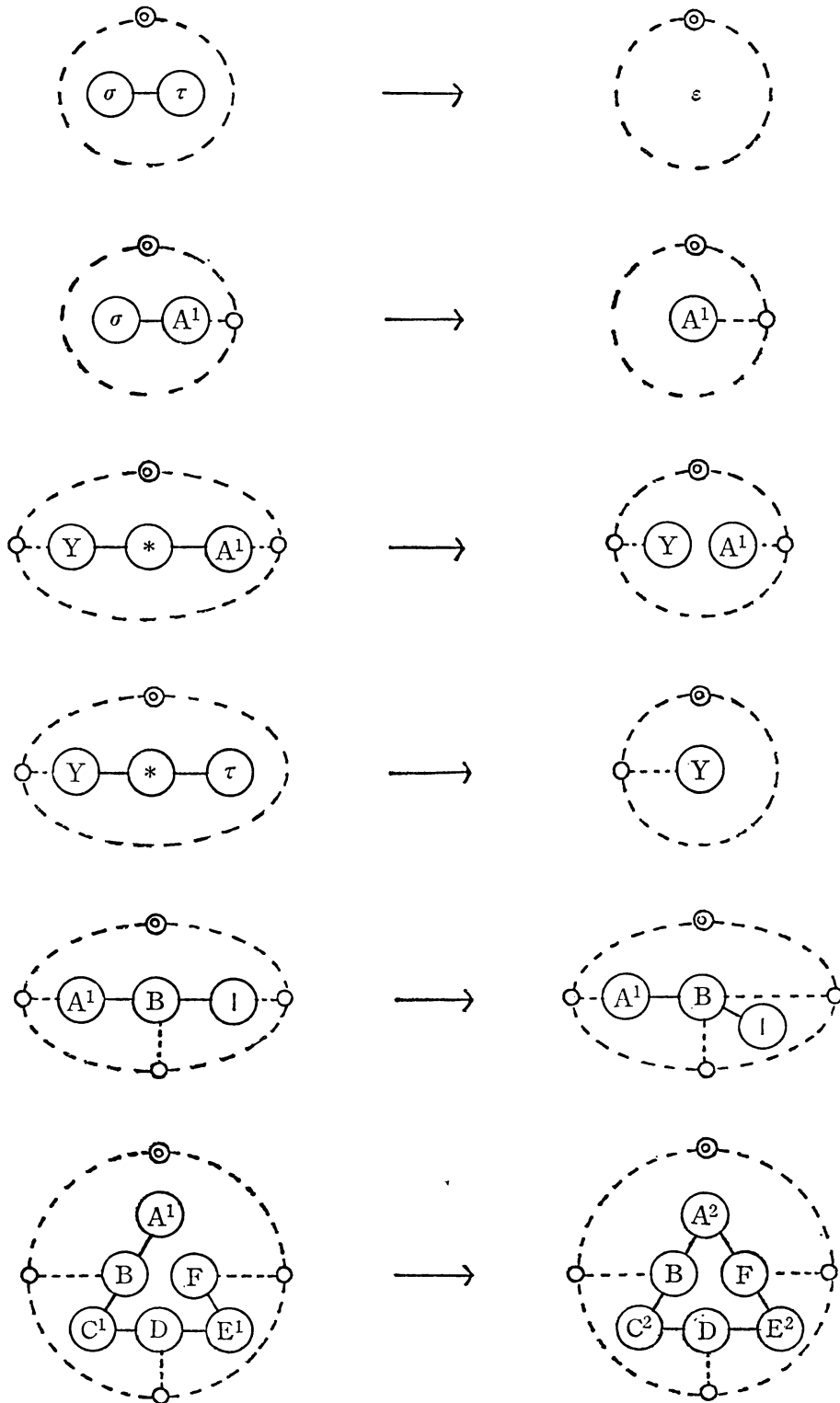
The set P_1 of productions

The set P_2 of productions

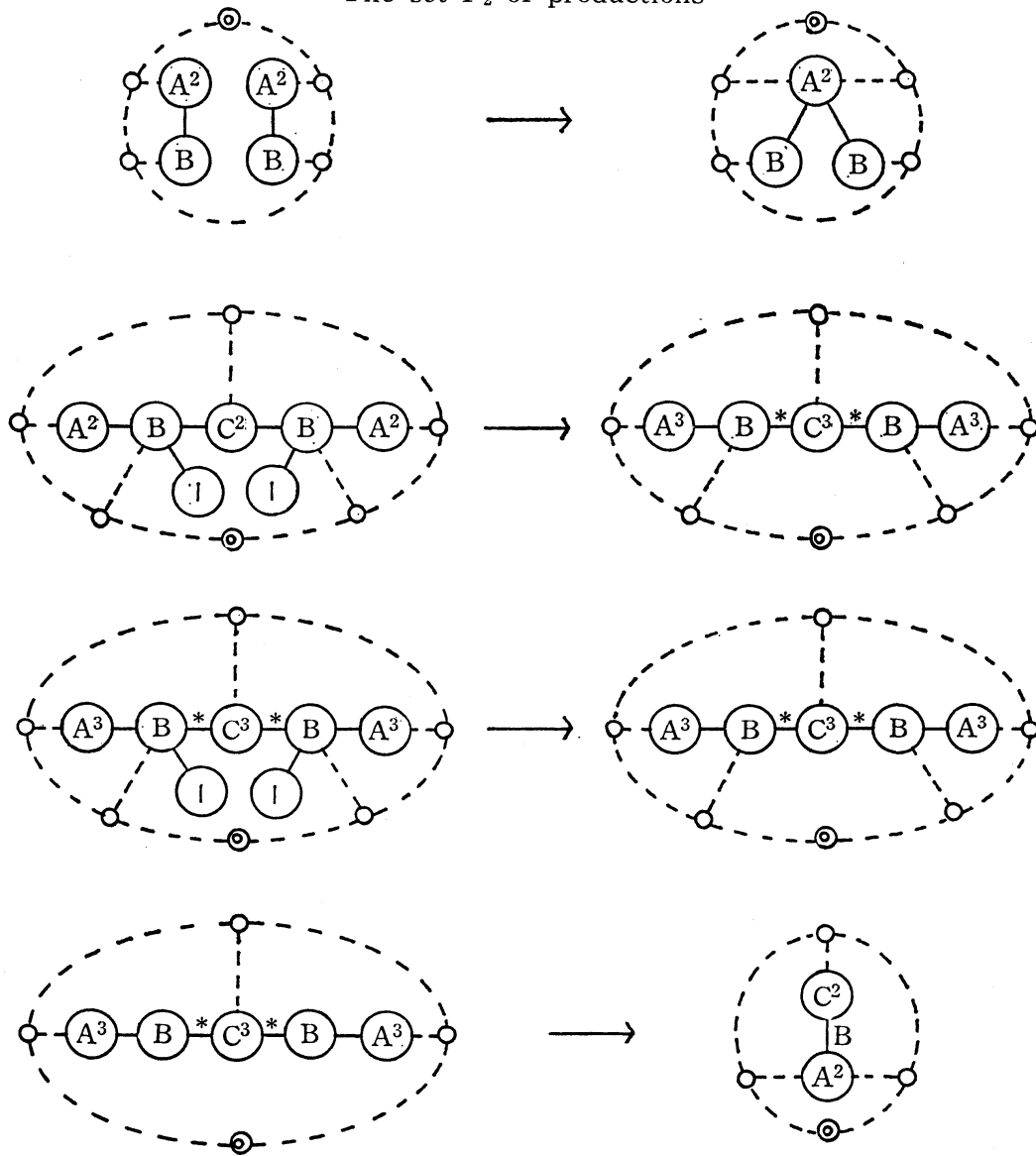

The set P_3 of productions

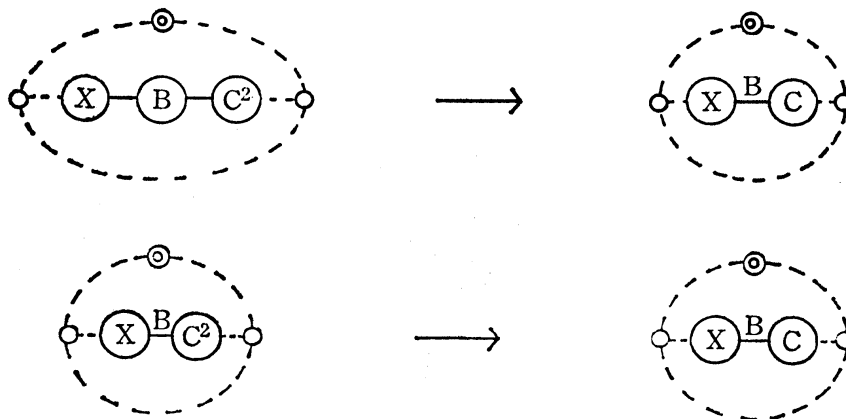

Set $P = P_1 \cup P_2 \cup P_3$. Let D be a Δ -map over Σ , and H a linear-plane-graph-expression of D . Now we show that D is derived from H according to P . Let H be of the form as shown in Figure 5.1. (In our figures, we omit the label λ .) First it is easily checked that the labelled plane graph H_1 as shown in Figure 5.2 is derived from H according to P_1 .

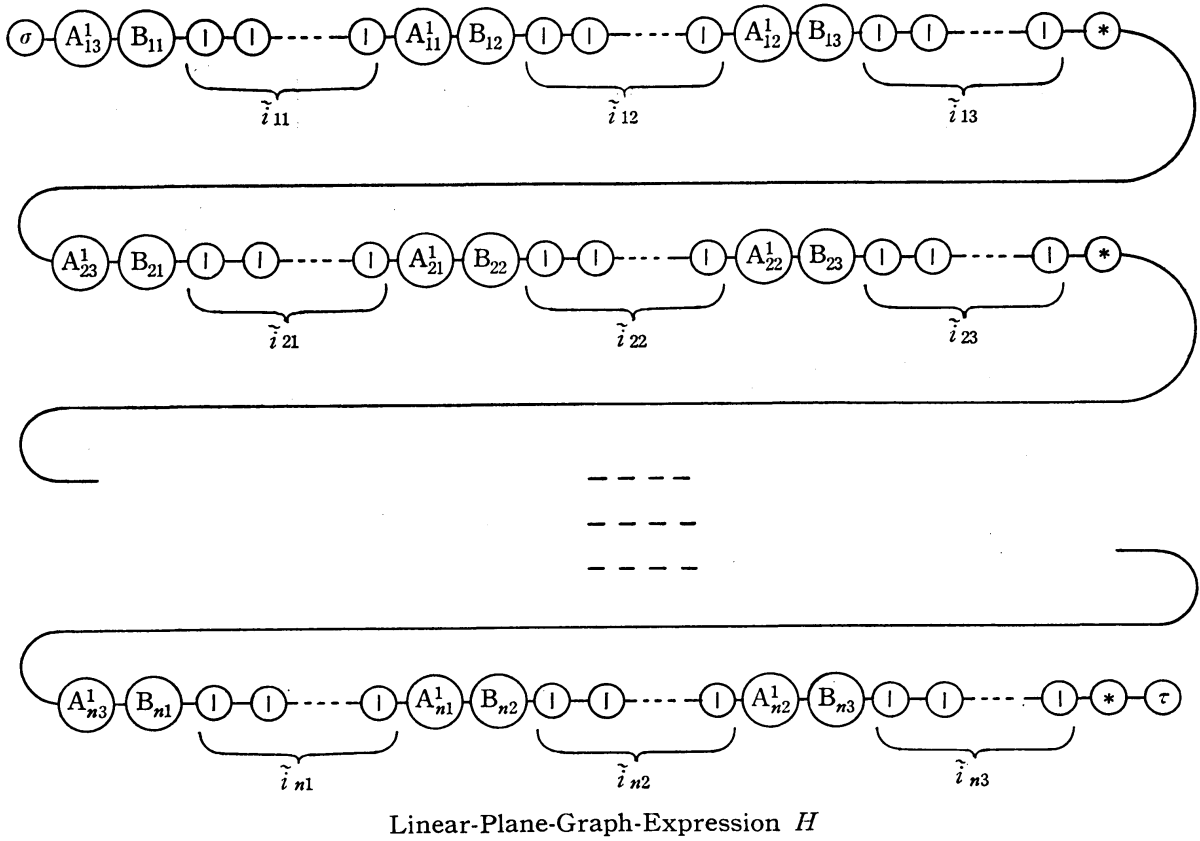

Linear-Plane-Graph-Expression H

Fig. 5.1

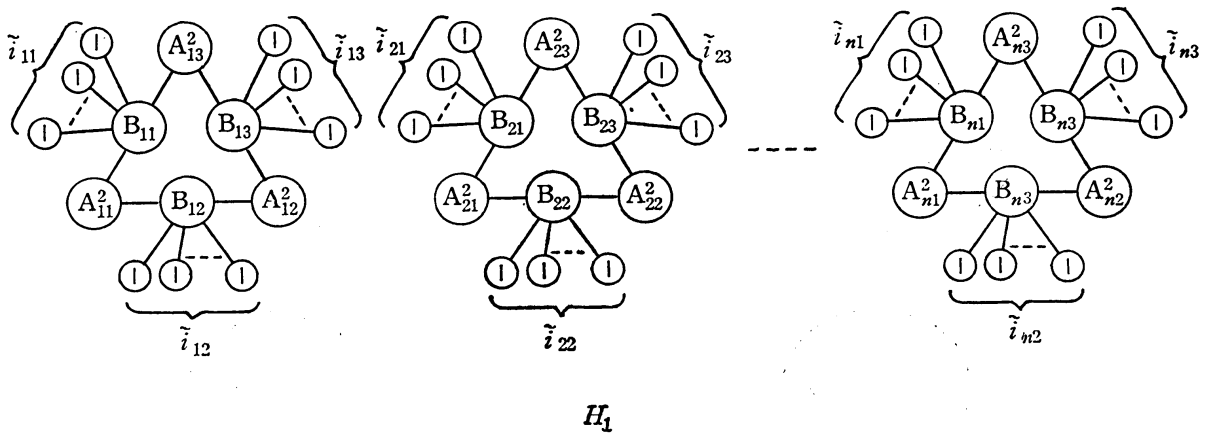

H_1

Fig. 5.2. Labelled plane graph H_1 derived from H according to P_1 .

If i_{12} is i_{21} , then A_{11} is A_{21} , B_{12} is B_{21} , A_{12} is A_{23} and $i_{12} = i_{21} \neq 0$, and so the labelled plane graph H_1^1 as shown in Figure 5.3 is derived from H_1 according to P_2 . If i_{13} is i_{31} , then the labelled plane graph H_1^2 as shown in Figure 5.4 is derived from H_1^1 according to P_2 . If i_{23} is i_{32} , then the labelled plane graph H_1^3 as shown in

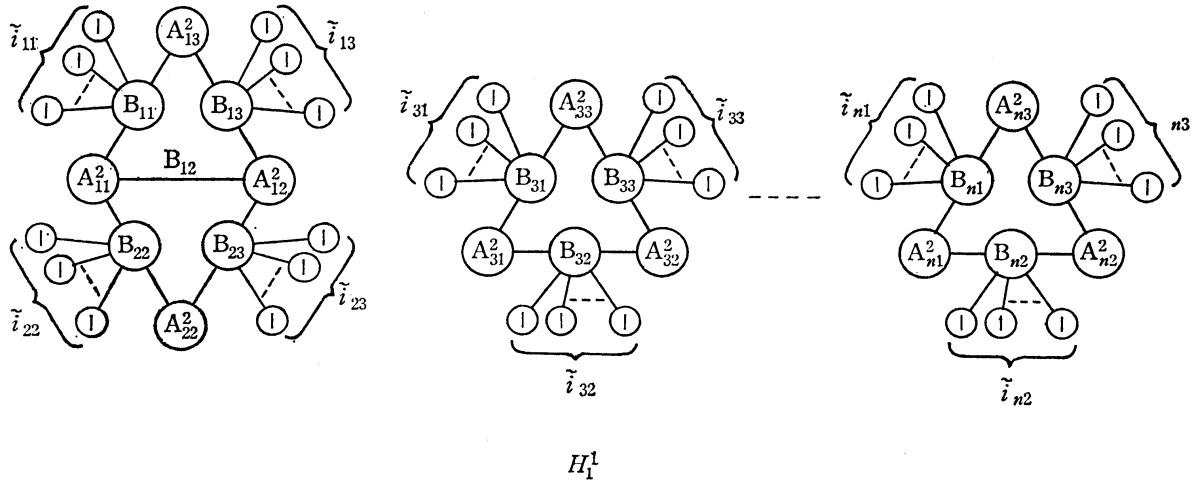

Fig. 5.3. When i_{12} is i_{21} , H_1^1 is derived from H_1 according to P_2 .

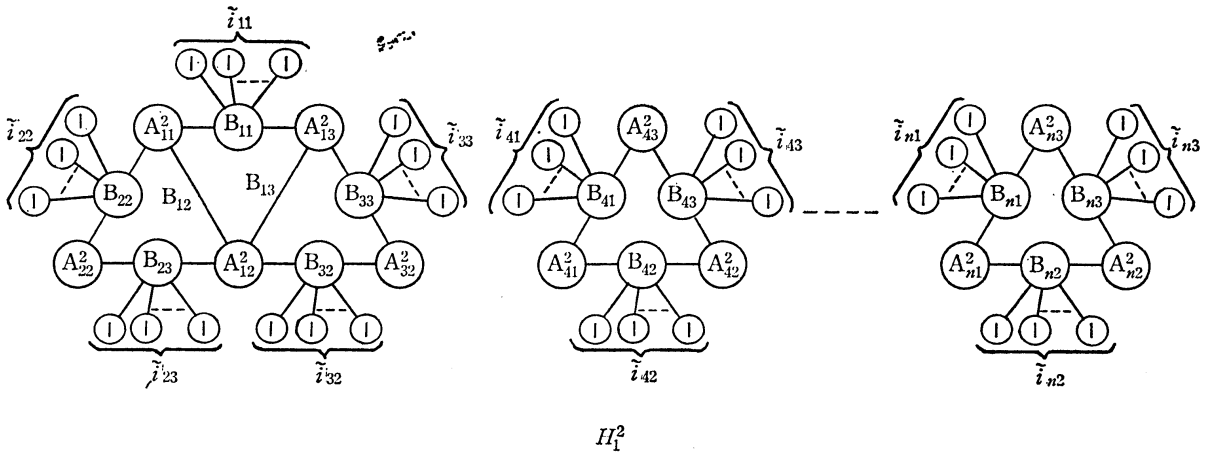

Fig. 5.4. When i_{13} is i_{31} , H_1^2 is derived from H_1^1 according to P_2 .

Figure 5.5 is derived from H_1^2 according to P_2 . In this way we get the labelled plane graph H_2 over $\Sigma \cup \Sigma_2 \cup \{\lambda\}$ which is derived from H_1 according to P_2 . For example, see Figure 5.6. Clearly the \mathcal{A} -map D is derived from H_2 according to P_3 . Therefore D is derived from H according to P . It is trivial that no other labelled plane graph over Σ than D is derived from H according to P . This completes the proof.

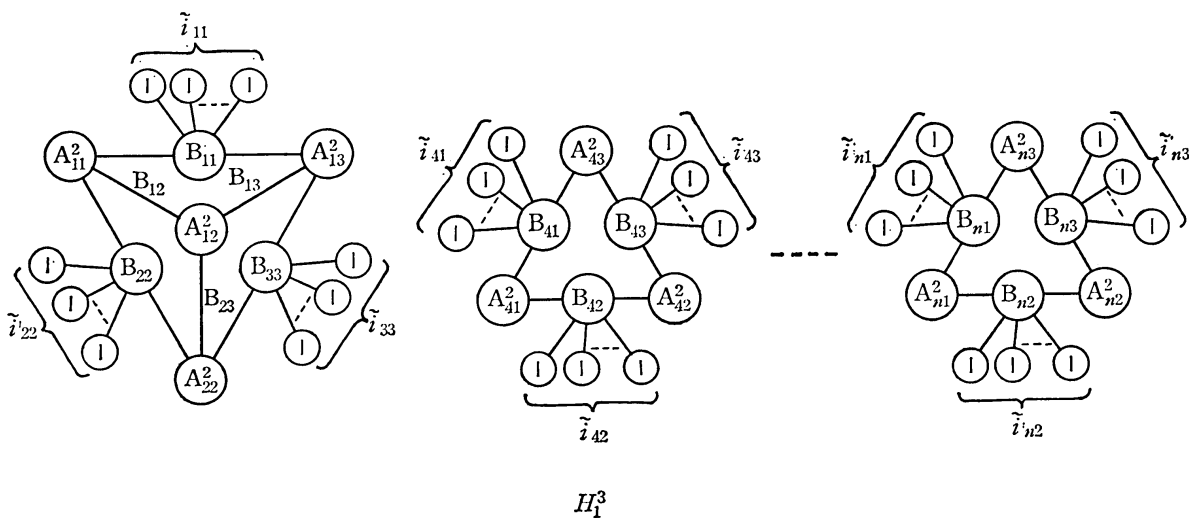

Fig. 5.5. When i_{23} is i_{32} , H_1^3 is derived from H_1^2 according to P_2 .

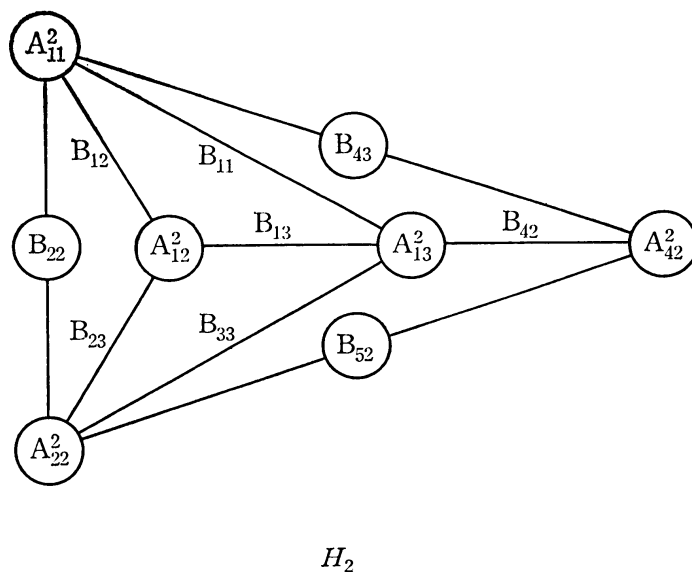

Fig. 5.6. When $n=5$, i_{12} is i_{21} , i_{13} is i_{31} , i_{23} is i_{32} , i_{11} is i_{41} , i_{33} is i_{51} , i_{42} is i_{53} , and $i_{22}=i_{43}=i_{52}=0$, H_2 is derived from H_1 according to P_2 .

We are now ready to prove Lemma:

PROOF OF LEMMA. Let R be a recursively enumerable set of \mathcal{A} -maps over Σ' , and σ, λ and τ labels not in Σ . Then, by Proposition 5.1, the set of all the linear-plane-graph-expressions with auxiliary labels σ, λ, τ of \mathcal{A} -maps in R is defined by a plane graph grammar. Therefore, by Sublemma and Proposition 3.2, there exists a plane graph grammar which defines R . This completes the proof.

Appendix. The completeness of the system of canonical plane graph grammars

We show that the system of canonical plane graph grammars is also complete.

We assume that each edge is a positive integer. We let $\Sigma, \Sigma_1, |, *$ and f_1 be the same as in § 5, and A^1 also denote $f_1(A)$ for each element A in Σ .

Now we modify the notion of a string-expression in Definition 5.1 as follows :

DEFINITION A. Let C be a non empty connected labelled plane graph over Σ . If $v_{0k_0}i_{01}v_{01}i_{02}v_{02}\cdots v_{0k_0-1}i_{0k_0}v_{0k_0}, v_{1k_1}i_{11}v_{11}i_{12}v_{12}\cdots v_{1k_1-1}i_{1k_1}v_{1k_1}, \cdots, v_{nk_n}i_{n1}v_{n1}i_{n2}v_{n2}\cdots v_{nk_n-1}i_{nk_n}v_{nk_n}$ is a sequence without repetition of all the boundary walks in the boundaries of C , where the first boundary walk $v_{0k_0}i_{01}v_{01}i_{02}v_{02}\cdots v_{0k_0-1}i_{0k_0}v_{0k_0}$ is the element in the exterior boundary of C , and if the label of v_{jk} is A_{jk} and the label of i_{jk} is B_{jk} for $j=1, 2, \dots, n; k=1, 2, \dots, k_j$, then the string

$$\underbrace{|\cdots|}_{i_{0k_0}}B_{0k_0}A_{0k_0-1}^1\cdots A_{02}^1|\underbrace{|\cdots|}_{i_{02}}B_{02}A_{01}^1|\underbrace{|\cdots|}_{i_{01}}B_{01}A_{0k_0}^1*$$

$$A_{1k_1}^1B_{11}|\underbrace{|\cdots|}_{i_{11}}A_{11}^1B_{12}|\underbrace{|\cdots|}_{i_{12}}A_{12}^1\cdots A_{1k_1-1}^1B_{1k_1}|\underbrace{|\cdots|}_{i_{1k_1}}*$$

.....

$$A_{nk_n}^1B_{n1}|\underbrace{|\cdots|}_{i_{n1}}A_{n1}^1B_{n2}|\underbrace{|\cdots|}_{i_{n2}}A_{n2}^1\cdots A_{nk_n-1}^1B_{nk_n}|\underbrace{|\cdots|}_{i_{nk_n}}$$

is called a *string-expression* of C . The empty string is the *string-expression* of the empty graph. A labelled plane graph H is called a *linear-plane-graph-expression* with auxiliary labels σ, λ, τ of C if there exists a string-expression of C whose plane-graph-expression with auxiliary labels σ, λ, τ is H .

In order to prove that the system of canonical plane graph grammars is complete, it is sufficient to show that the following lemma (cf. Sublemma in § 5):

LEMMA A. *Let σ, λ and τ be labels not in Σ . There exists a finite set P of canonical productions such that for each connected labelled plane graph C over Σ and for each linear-plane-graph-expression H with auxiliary labels σ, λ, τ of C, C is the unique labelled plane graph over Σ derived from H according to P .*

PROOF. Let Π, Σ_2, Σ_3 and Σ_4 be alphabets such that $\Pi, \Sigma, \Sigma_1, \Sigma_2, \Sigma_3, \Sigma_4$ and $\{ |, * \}$ are mutually disjoint, and let $\sigma, \lambda, \tau, \#, \natural, |^0, |^1$ and $|^2$ be labels not in $\Pi \cup \Sigma \cup \Sigma_1 \cup \Sigma_2 \cup \Sigma_3 \cup \Sigma_4 \cup \{ |, * \}$. Let f_i be a one-to-one correspondence from Σ to Σ_i for $i=2, 3, 4$, and g a one-to-one correspondence from $\Sigma \times (\Sigma \cup \Sigma_1 \cup \{ |, *, \tau, \natural \})$ to Π . For each element A in Σ , let A^i denote $f_i(A)$ for $i=2, 3, 4$, and for each element (A, W) in $\Sigma \times (\Sigma \cup \Sigma_1 \cup \{ |, \sigma, \tau, \natural \})$, let A^W denote $g(A, W)$. Let P_i ($i=1, 2, \dots, 9$) be the set of simple productions as follows :

STIPULATION: $A, B, C \in \Sigma$. $X, Y \in \Sigma \cup \Sigma_1 \cup \{\emptyset\}$. $Z \in \Sigma \cup \{\lambda\}$. $S, T \in \Sigma_1 \cup \{\emptyset\}$.
 $U \in \Sigma \cup \Sigma_1$. $V \in \Sigma \cup \Sigma_1 \cup \{\emptyset, \tau\}$. $i=0, 1$.

The lines without label denote edges with label λ .

The set P_1 of canonical productions

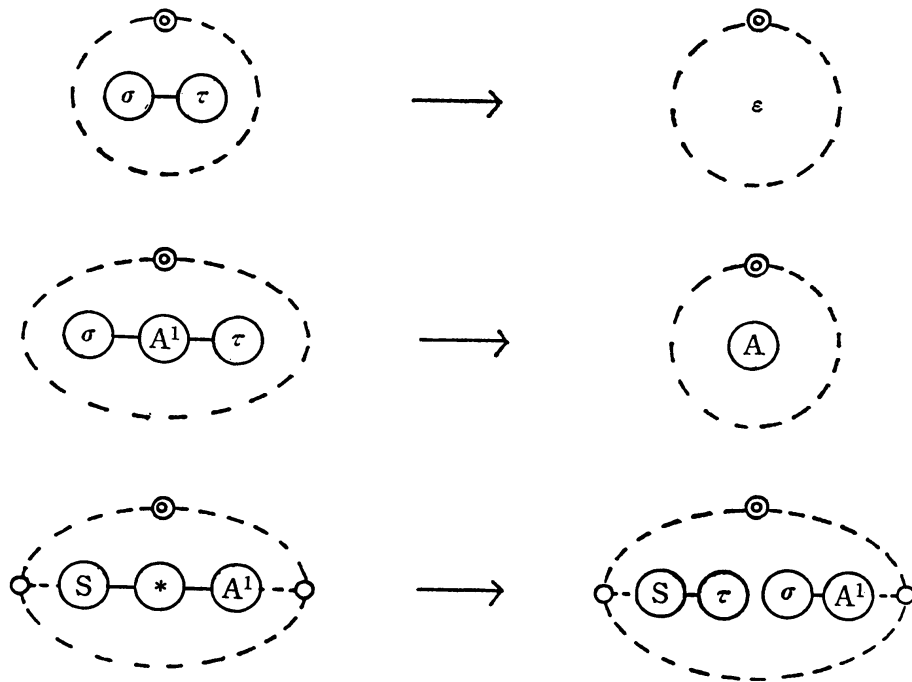

The set P_2 of canonical productions

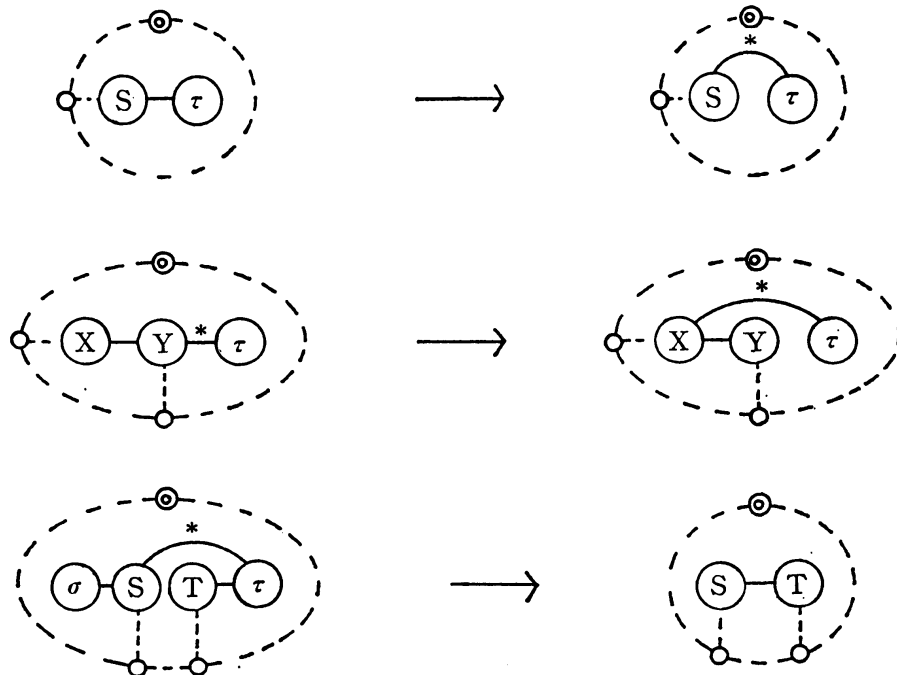

The set P_3 of canonical productions

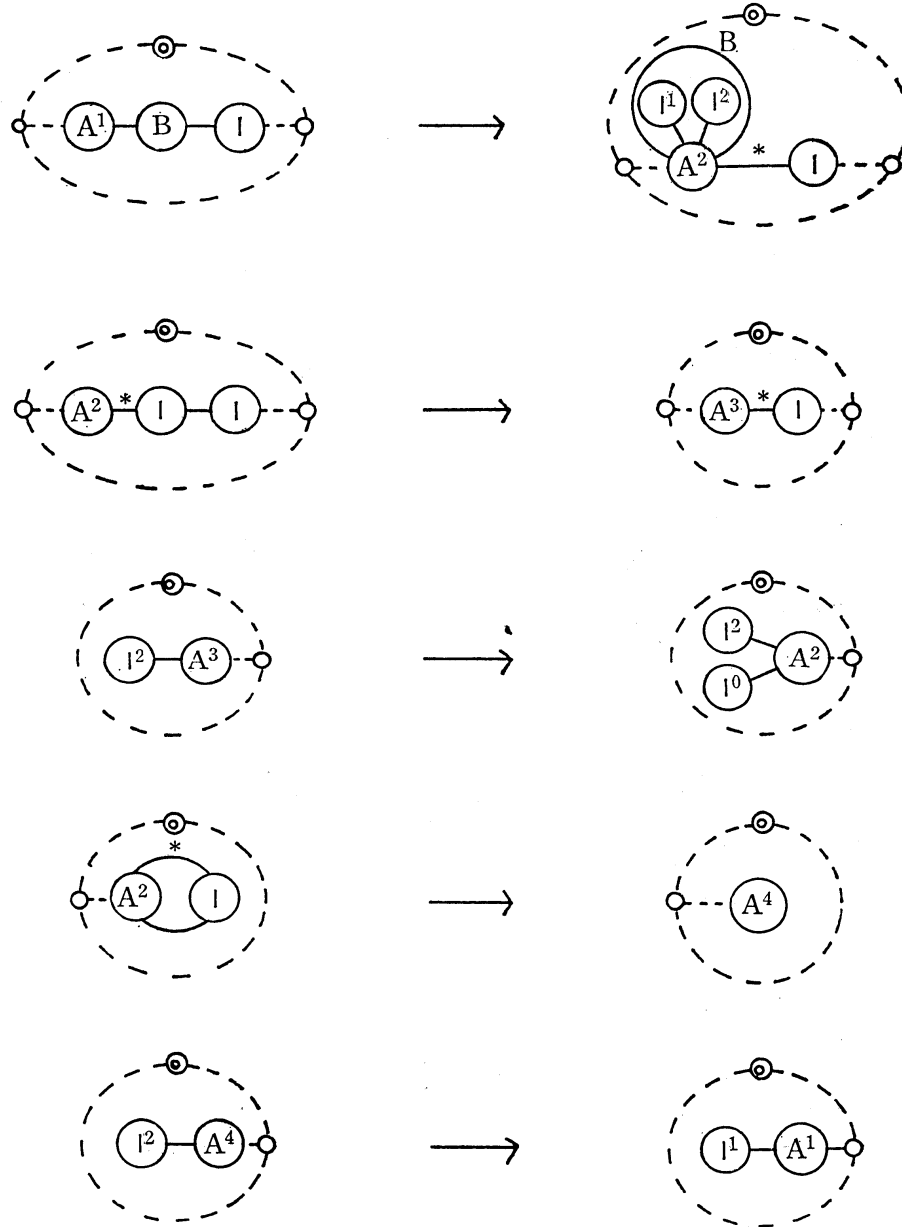

The set P_4 of canonical productions

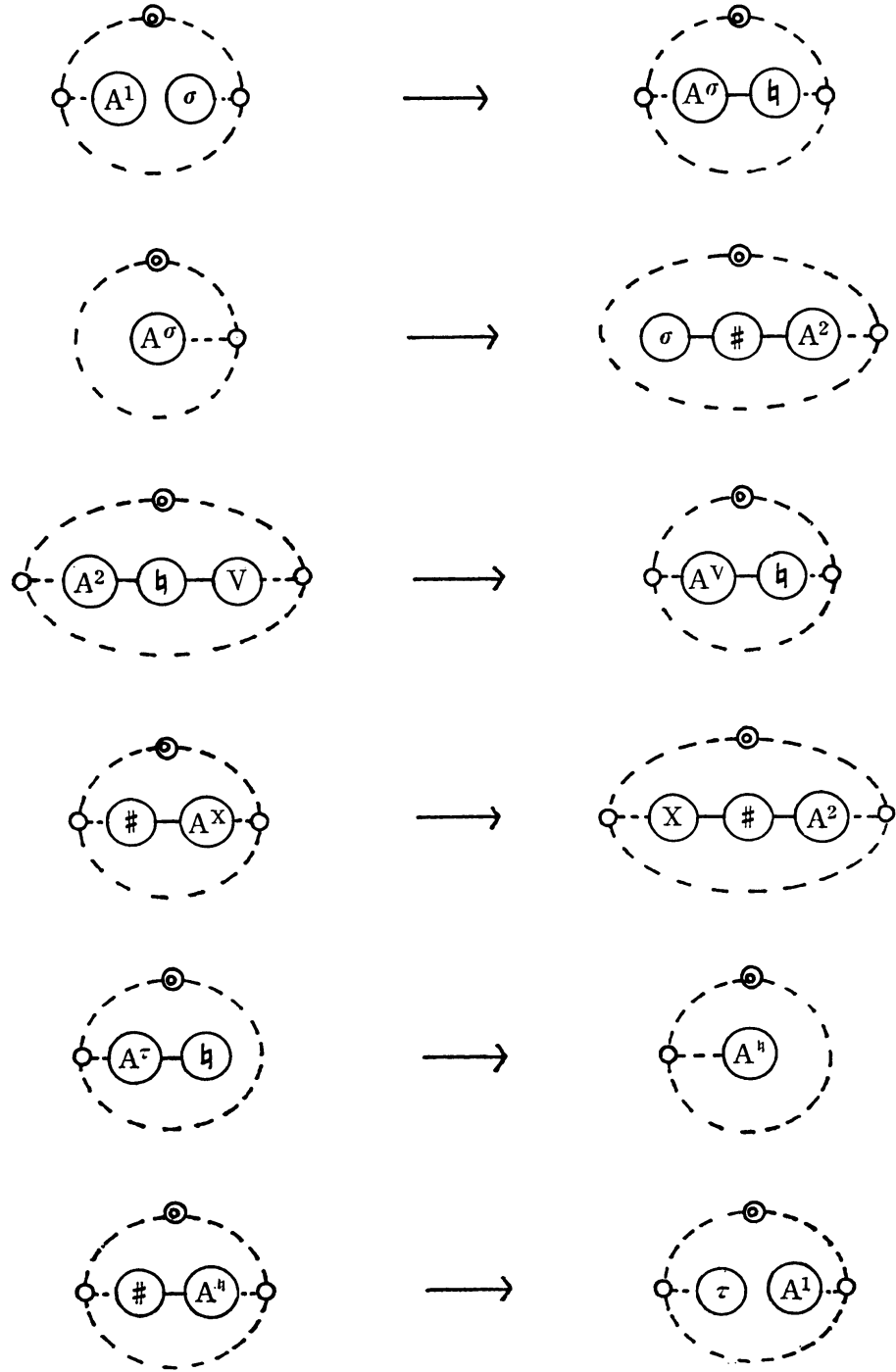

The set P_5 of canonical productions

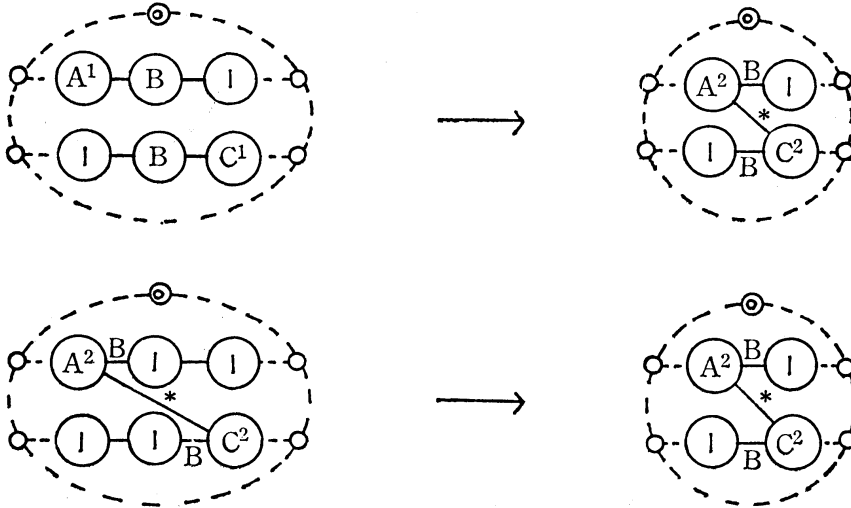

The set P_6 of canonical productions

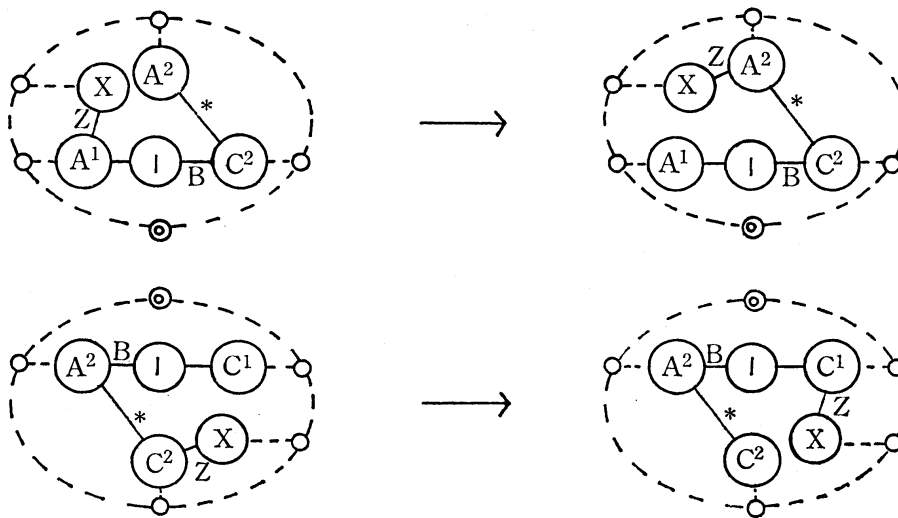

The set P_7 of canonical productions

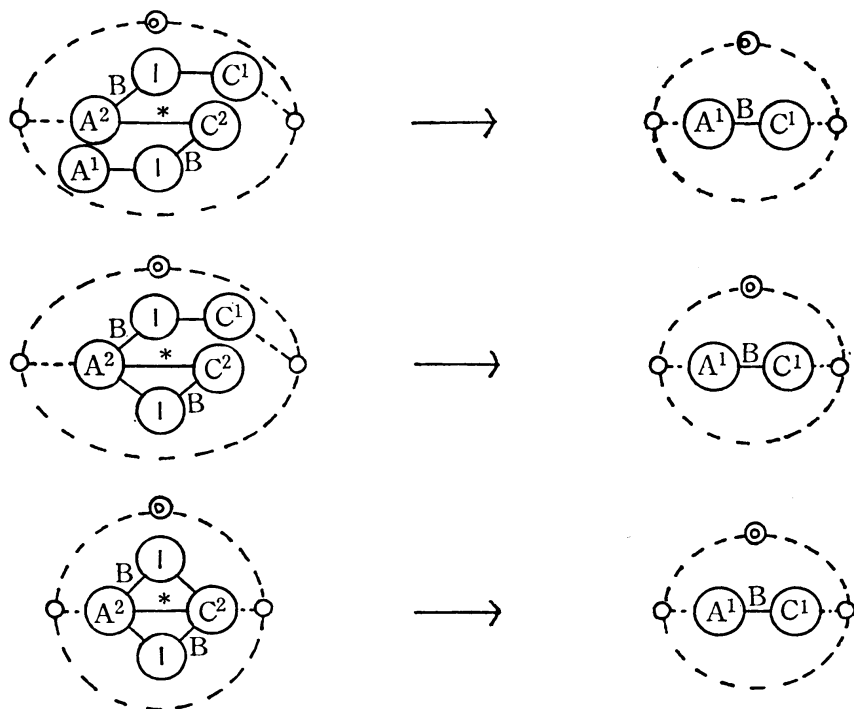

The set P_8 of canonical productions

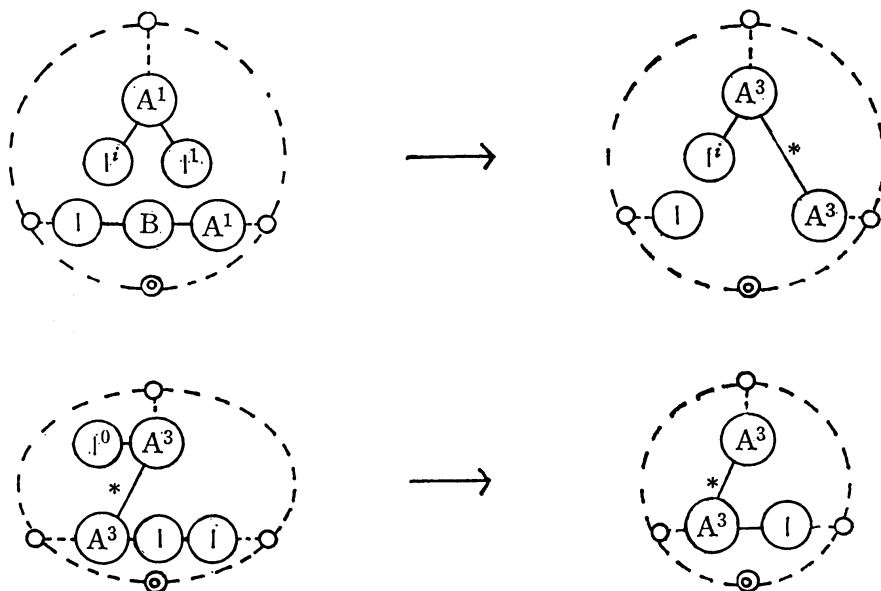

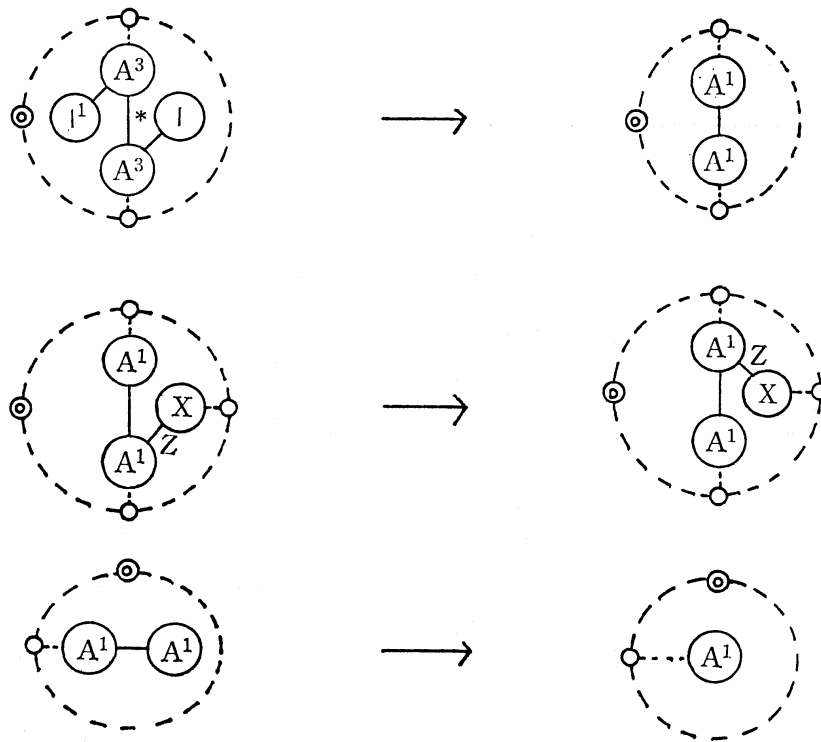

The set P_9 of canonical productions

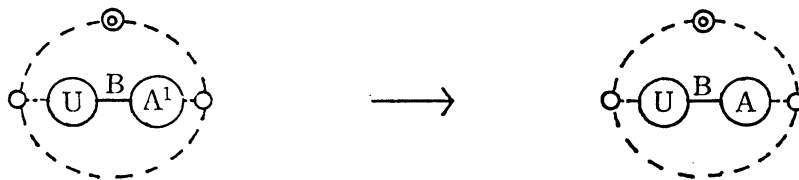

Set $P = P_1 \cup P_2 \cup P_3 \cup P_4 \cup P_5 \cup P_6 \cup P_7 \cup P_8 \cup P_9$. Then P satisfies the condition of this Lemma. We illustrate the proof for it with an example. Let $\Sigma = \{A_1, A_2, A_3, A_4, B_1, B_2, B_3, B_4, B_5, B_6\}$ and let C be the connected labelled plane graph over Σ as

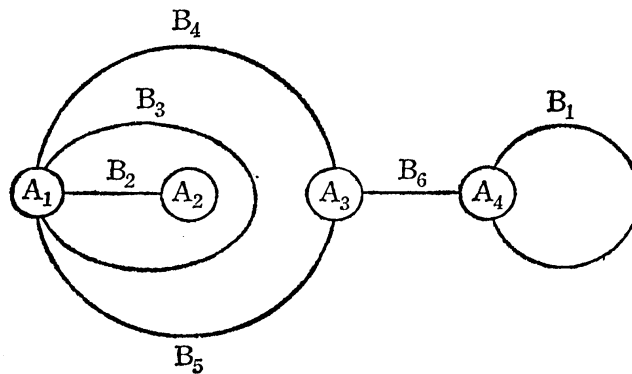

Fig. A.1

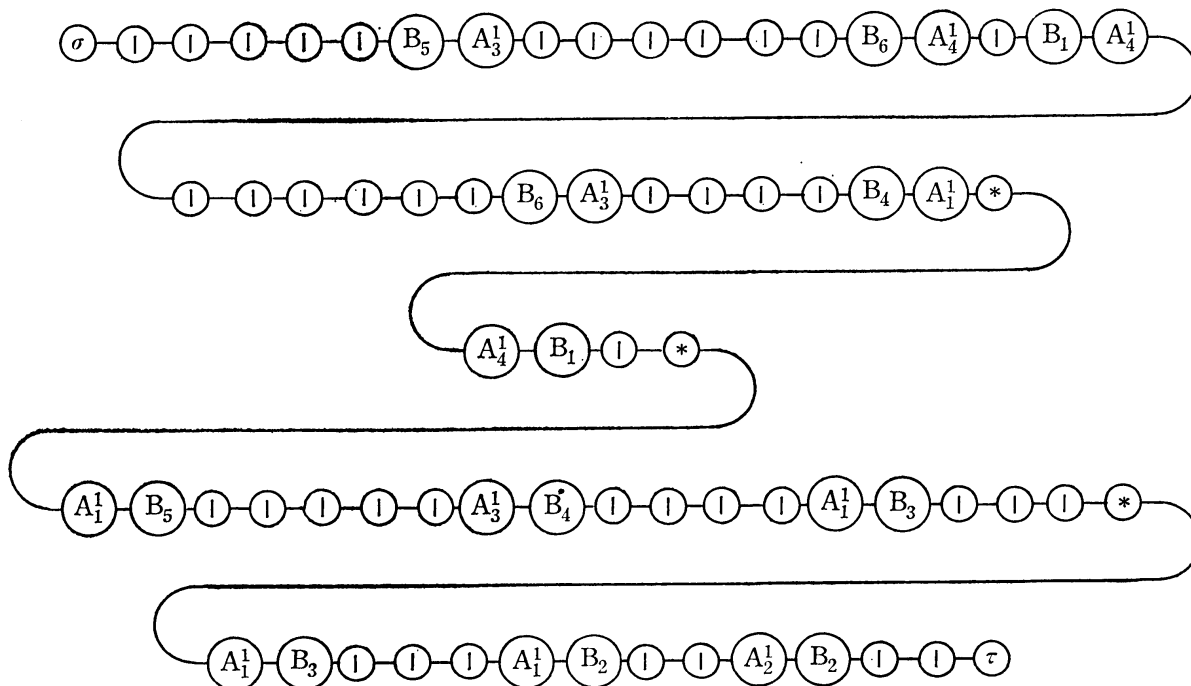

Fig. A.2

shown in Figure A.1, where the edge i has the label B_i ($i=1, 2, \dots, 6$). And let H be the linear-plane-graph-expression of C as shown in Figure A.2. Let H_i be the labelled plane graph as shown in Figure A.i ($i=3, 4, \dots, 9$). Then

$$H \xrightarrow{1,2} H_3 \xrightarrow{3,5,6,7} H_4 \xrightarrow{4} H_5 \xrightarrow{2,5,6,7} H_6 \xrightarrow{3,4} H_7 \xrightarrow{2,5,6,7} H_8 \xrightarrow{8} H_9 \xrightarrow{9} C,$$

where $\xrightarrow{i, \dots, j}$ means that the right-hand side is derived from the left-hand side according to $P_i \cup \dots \cup P_j$. It is trivial that C is the unique labelled plane graph over Σ derived from H according to P .

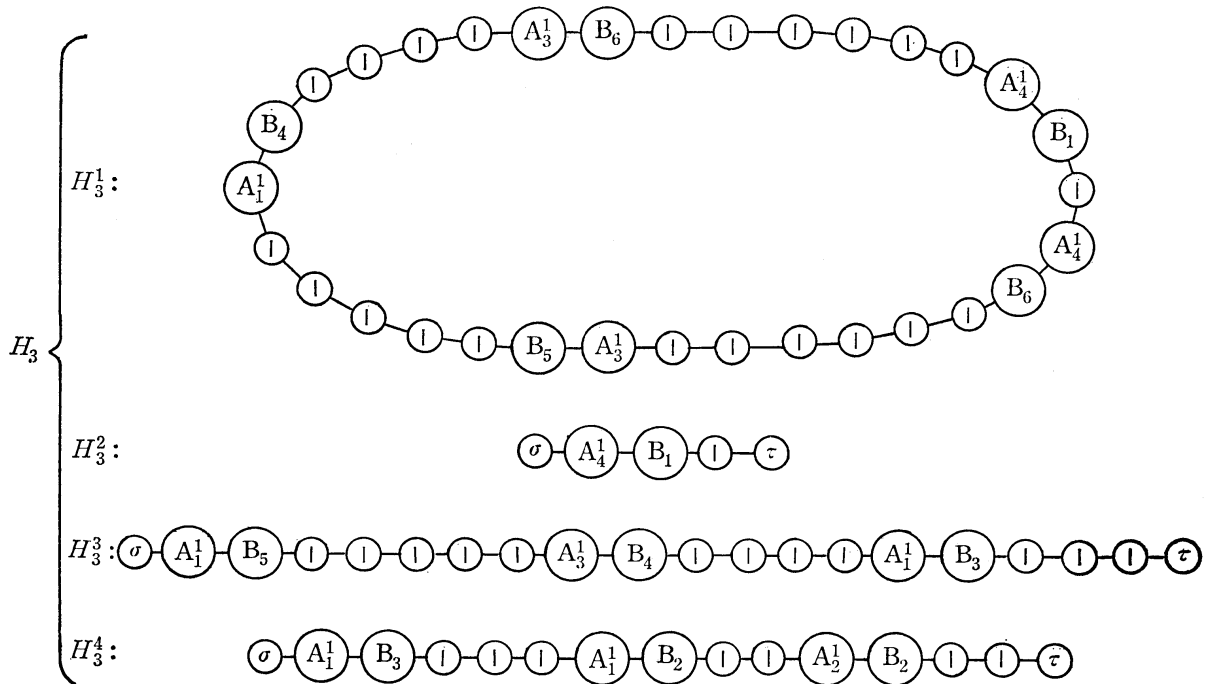

Fig. A.3. H_3 is derived from H according to $P_1 \cup P_2$.

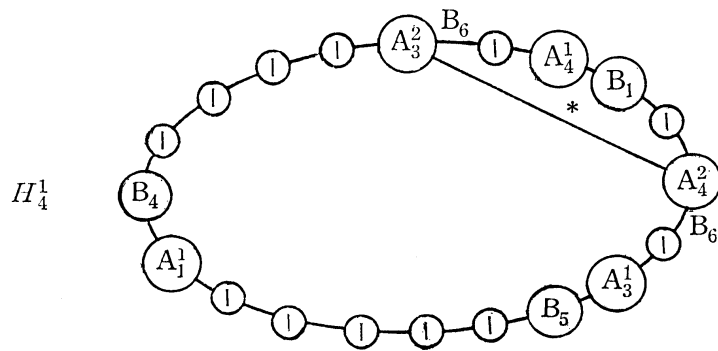

Fig. A.4-1. H_4^1 is derived from H_3^1 according to P_5 .

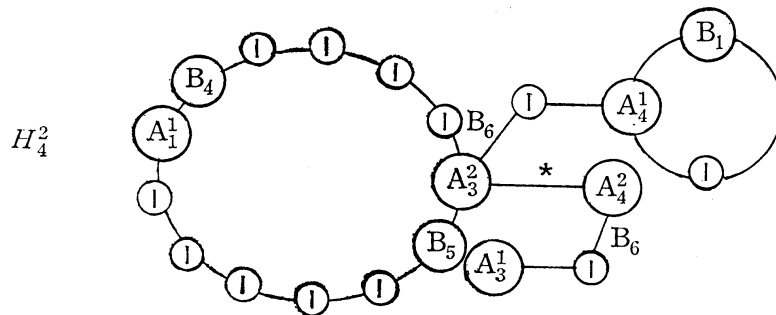

Fig. A.4-2. H_4^2 is derived from H_4^1 according to P_6 .

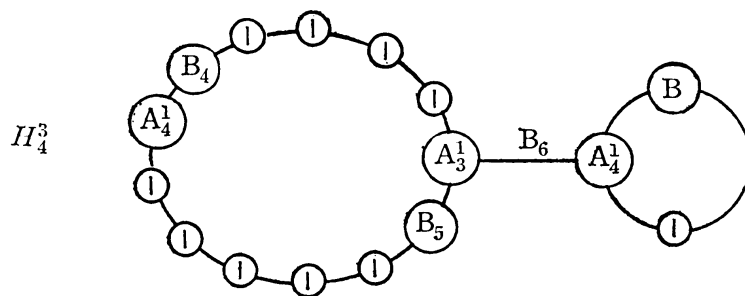

Fig. A.4-3. H_4^3 is derived from H_4^2 according to P_7 .

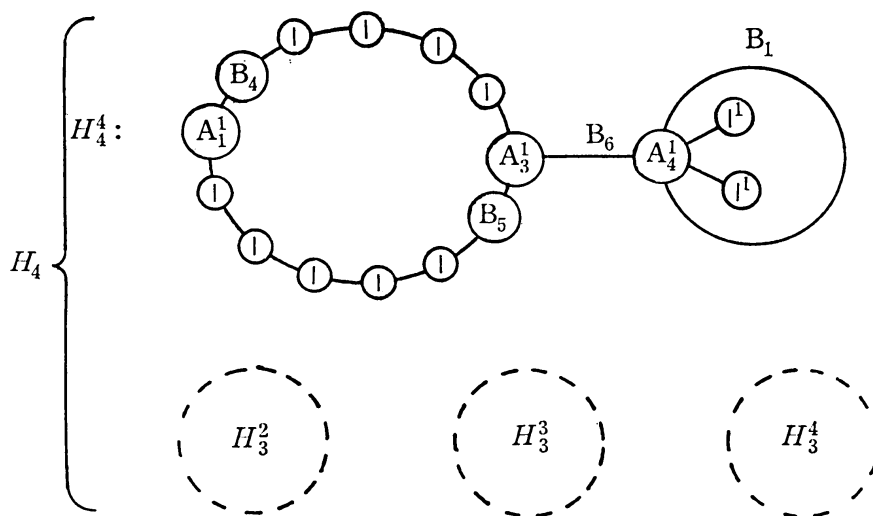

Fig. A.4. H_4^4 is derived from H_4^3 according to P_3 , so H_4 is derived from H_3 according to $P_3 \cup P_5 \cup P_6 \cup P_7$.

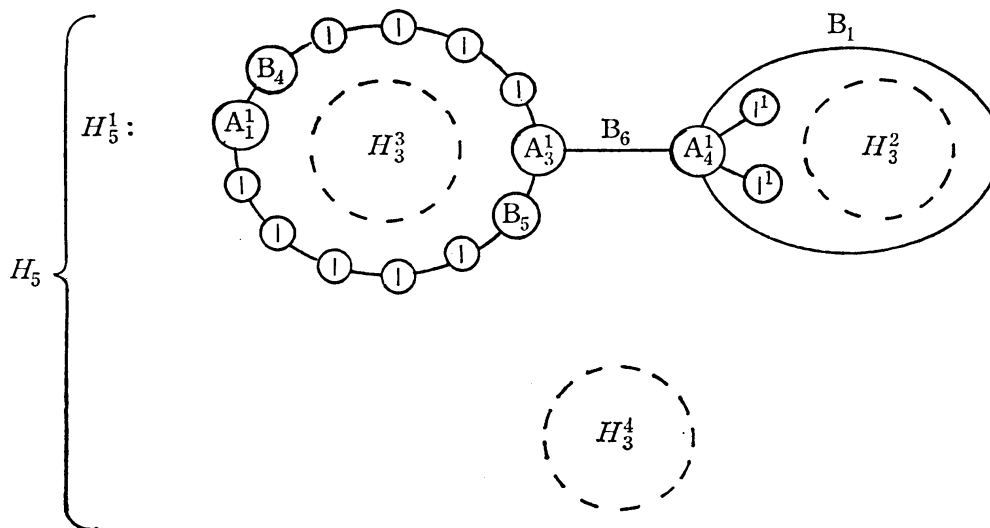

Fig. A.5. H_5 is derived from H_4 according to P_4 .

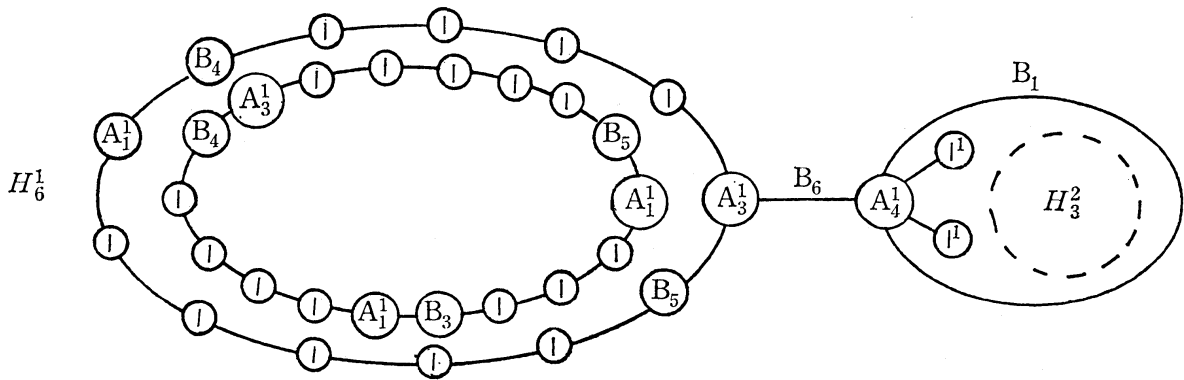

Fig. A.6-1. H_6^1 is derived from H_5^1 according to P_2 .

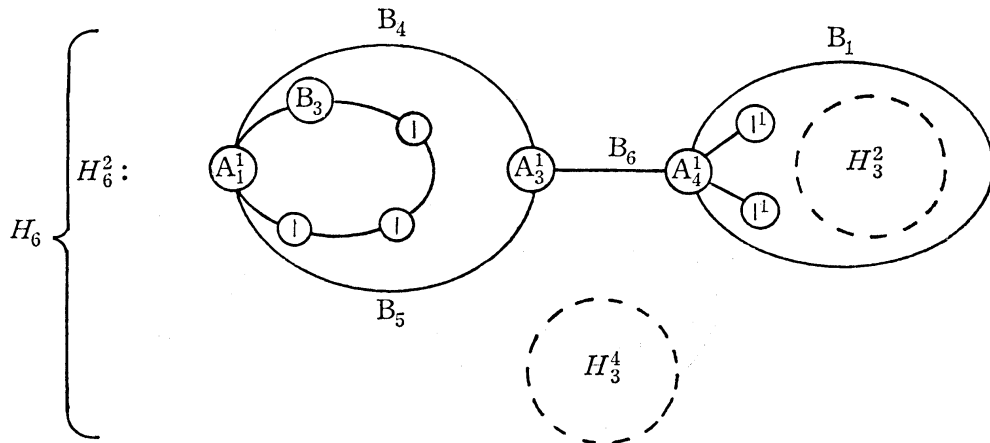

Fig. A.6. H_6^2 is derived from H_6^1 according to $P_5 \cup P_6 \cup P_7$, so H_6 is derived from H_5 according to $P_2 \cup P_5 \cup P_6 \cup P_7$.

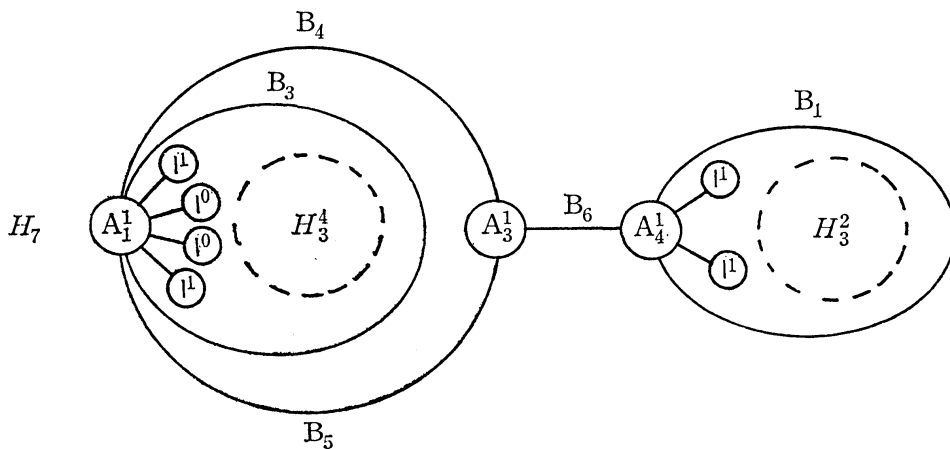

Fig. A.7. H_7 is derived from H_6 according to $P_3 \cup P_4$.

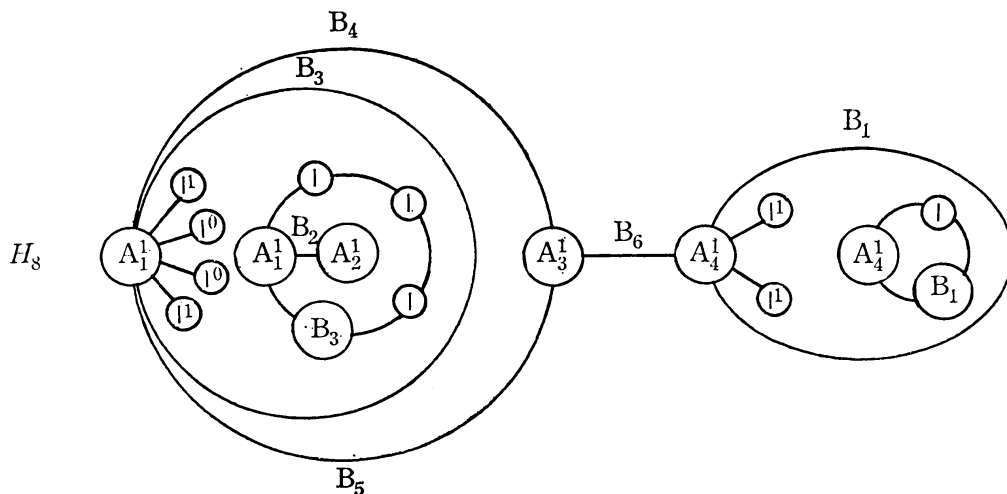

Fig. A.8. H_8 is derived from H_7 according to $P_2 \cup P_5 \cup P_6 \cup P_7$.

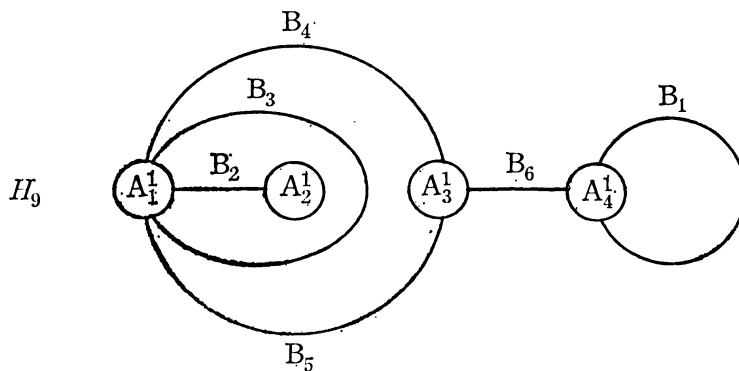

Fig. A.9. H_9 is derived from H_8 according to P_8 .

References

- [1] Uesu, T., A system of graph grammars which generates all recursively enumerable sets of labelled graphs, Tsukuba Journal of Mathematics 2 (1978) 11-26.
- [2] Yoshimura, S., S. Noguchi & J. Oizumi, Web grammars using regional information and generation of plane graphs (in Japanese), The Record of Electrical and Communication Engineering Conversation Tohoku University 43 (1974) 61-69.
- [3] Yoshimura, S., S. Noguchi & J. Oizumi, Several properties of plane-web grammars (in Japanese), The Transaction of the Institute of Electronics and Communication Engineers of Japan J60-D (1977) 387-394.

Tadahiro UESU
 Department of Mathematics
 Faculty of Science
 Kyushu University
 Fukuoka, Postal No. 812, Japan