

Differentiability of p -central Cantor sets

Sergio PLAZA* and Jaime VERA**

(Received June 8, 1994; Revised November 20, 1996)

Abstract. We provide, for each $r \geq 1$, a geometrical construction of Cantor sets which are regular of class C^r , and whose self-arithmetic difference is a Cantor set of positive Lebesgue measure. When $r \geq 2$ these Cantor sets are dynamically defined. We construct a diffeomorphism on the sphere with a basic set equal to the product of those Cantor sets which we constructed.

Key words: Cantor sets, regular Cantor sets, dynamically defined Cantor sets, Hausdorff dimension and limit capacity.

1. Introduction

In the study of bifurcations of a generic one-parameter family of surface diffeomorphisms having a generic homoclinic tangency at a parameter value, the arithmetic difference (sum) of two Cantor sets appears in a natural way (cf. [PT]).

The problem about the topological or measure-theoretical structure of the arithmetic difference of two Cantor sets, both with zero Lebesgue measure, has been considered by M. Hall [H] in his work related to Number Theory where he uses the concept of *thickness* in order to obtain results on the sets of the sum and of the product of sets of continued fractions. Motivated by dynamical systems problems, S. Newhouse rediscovered the concept of thickness and used it in the study of, what he called, “wild hyperbolic sets of surface diffeomorphisms” (see [N]). J. Palis (based on his joint work with F. Takens on homoclinic bifurcations on surface diffeomorphisms [PT,1] and [PT,2]) has renewed the interest for the problem of the measure-theoretical and topological structure of the difference of two Cantor sets, since, as we mentioned above, these sets arise in a natural way in

1991 Mathematics Subject Classification : Primary 28A05, 58F12, Secondary 28A80, 28A12.

*Part of this work was supported by FONDECYT grants #0449/91 and #1930026, and DICYT Grant #9133 P.S.

**Part of this work was supported by FONDECYT grants #0449/91 and #1930026, and a UCANORTE Grant.

this branch of dynamical systems. It is important to note that the Cantor sets which appear in the study of homoclinic bifurcations of surface diffeomorphisms are *regular* in a sense which we will explain. Following Palis and Takens, we call these Cantor sets *dynamically defined* (for more details see [PT]).

In order to establish more precisely the problems related to the difference set of two Cantor sets, we recall some definitions.

Let $I \subset \mathbb{R}$ be a closed interval, and let $\Lambda \subset I$ be a Cantor set. We will say Λ is *regular* of class C^r , $r \geq 1$, if there are closed disjoint intervals I_1, \dots, I_k of I , a C^r map $\varphi : \bigcup_{i=1}^k I_i \rightarrow I$ such that $\Lambda = \bigcap_{n \geq 0} \varphi^{-n}(I_1 \cup \dots \cup I_k)$ and, for each $i = 1, \dots, k$, the restriction $\varphi_i = \varphi|_{I_i} : I_i \rightarrow I$ is an onto and expanding map: that is, $|\varphi'_i(x)| > 1$, for all $x \in I_i$. The Cantor set Λ is called *affine* if each φ_i of above is an affine map. Recall that given $A, B \subset \mathbb{R}$, the arithmetic difference set of A and B , $A - B$, is

$$A - B = \{x - y : x \in A, y \in B\} = \{\mu \in \mathbb{R} : A \cap (B + \mu) \neq \emptyset\}$$

where $B + \mu = \{y + \mu : y \in B\}$ is the translation of B by μ .

In [PT,1] Palis has proposed several problems concerning the structure of the difference set of two regular Cantor sets, e.g.,

Is it true, at least generically or for most regular, of class C^r ($r \geq 2$), Cantor sets Λ_1 and Λ_2 , that the arithmetic difference set $\Lambda_1 - \Lambda_2$ has zero Lebesgue measure or else contains intervals ?

Concerning this problem, A. Sannami in [S] has constructed an example of a C^∞ regular Cantor set, $\Lambda \subset \mathbb{R}$, such that $\Lambda - \Lambda$ is a Cantor set with positive Lebesgue measure. Thus the answer to the problem is negative when we are considering the set of all regular Cantor sets. This example is very rigid, hence a positive answer is possible in a generic sense or for most Cantor sets. On the other hand, in [L] P. Larsson has constructed random Cantor sets obtaining similar results to those of A. Sannami. Nevertheless, these Cantor sets are far from being regular. In [MO] P. Mendes and F. Oliveira have studied the topological structure of the difference of two Cantor sets, thus obtaining a classification of the topological structures for the class of homogeneous Cantor sets. This classification consists of five possible types of structures: a Cantor set, a closed interval, and three others which they call L , R and M Cantorvals.

Finally, mention must be made to the fact that J. Palis and F. Takens,

in their joint work [PT,1] and [PT,2], and also S. Newhouse in [N] have used numerical invariants of Cantor sets, *limit capacity*, *Hausdorff dimension* and *thickness*, to obtain criteria which give partial answers to these problems (see Section 8 or [PT] for the definitions of these concepts). For example, if $\Lambda_1, \Lambda_2 \subset \mathbb{R}$ are Cantor sets with limit capacities d_1 and d_2 , respectively, and $d_1 + d_2 < 1$, then $\Lambda_1 - \Lambda_2$ has zero Lebesgue measure. On the other hand, if the Hausdorff dimensions h_1 and h_2 of Λ_1 and Λ_2 , respectively, are such that $h_1 + h_2 > 1$, then for almost all (in the Lebesgue measure sense) $\gamma \in \mathbb{R}$, $\Lambda_1 - \gamma\Lambda_2$ has positive Lebesgue measure where $\gamma\Lambda_2 = \{\gamma x : x \in \Lambda_2\}$. Moreover, if Λ_1 and Λ_2 are such that $\Lambda_1 \cap \text{hull}(\Lambda_2)$ and $\text{hull}(\Lambda_1) \cap \Lambda_2$ are both nonempty, and their respective thicknesses $\tau(\Lambda_1)$ and $\tau(\Lambda_2)$ satisfy $\tau(\Lambda_1)\tau(\Lambda_2) > 1$, then the Gap Lemma in [N] yields that $\Lambda_1 \cap \Lambda_2$ is nonempty and that $\Lambda_1 - \Lambda_2$ has interior points.

2. Basic Concepts and Results

Throughout and without loss of generality, we will consider Cantor sets contained in the unit interval $I = [0, 1]$.

In order to establish our results we first recall some definitions.

Definition 1 Let $\Lambda \subset I$ be a Cantor set. We will say Λ is a C^r -regular Cantor set, $r \geq 0$, if there are closed disjoint intervals I_1, \dots, I_k of I , and strictly monotone expanding maps $\varphi_i : I_i \rightarrow I$, $i = 1, \dots, k$, which are of class C^r on Λ and such that

$$\Lambda = \bigcap_{n=0}^{\infty} \bigcup_{\sigma \in \Sigma_n^k} \varphi_{\sigma(1)}^{-1} \circ \dots \circ \varphi_{\sigma(n)}^{-1}(I),$$

where $\Sigma_n^k = \{\sigma : \{1, \dots, n\} \rightarrow \{1, \dots, k\}\}$.

Furthermore, when $r \geq 2$ we will say the Cantor set Λ is dynamically defined.

Remark 1. In the above definition, a C^r ($r \geq 0$) expanding map means $|\varphi_i(x) - \varphi_i(y)| > \alpha|x - y|$, $x, y \in \Lambda$, where $\alpha > 1$. For the case $r \geq 1$, the above condition reduces to $|\varphi_i'(x)| \geq \alpha > 1$, $x \in \Lambda$.

Definition 2 Let $\Lambda \subset I$ be a Cantor set. Let $p \geq 1$ be an integer. We will say Λ is a p -central Cantor set if there is a sequence of real numbers $s = (\lambda_n)_{n \in \mathbb{N}}$ with $\lambda_0 = 1$ and, for any $n \geq 1$, $0 < \lambda_n < \frac{1}{p+1}$, such that $\Lambda = \bigcap_{n=0}^{\infty} I^n$, where $I^0 = [0, 1]$ and I^{n+1} is the union of $(p+1)^{n+1}$ closed

disjoint intervals of length $\prod_{i=1}^{n+1} \lambda_i$ obtained from I^n by removing the p open central intervals each of length $\frac{(1-(p+1)\lambda_{n+1})}{p} \prod_{i=1}^n \lambda_i$ in each connected component I_j^n of I^n . Let $\Lambda(p, s)$ denote the Cantor set Λ .

If $\lambda_1 = \lambda_2 = \dots = \lambda_n = \dots = \alpha$ in Definition 2, the Cantor set thus obtained is called the p - α -central Cantor set and denoted $\Lambda(p, \alpha)$.

Remark 2. Since the length of each connected component I_j^n of I^n is $\prod_{i=1}^n \lambda_i$, the Lebesgue measure of the p -central Cantor set thus obtained is

$$\lim_{n \rightarrow \infty} \prod_{i=1}^n (p+1) \lambda_i = \lambda, \quad \lambda \in [0, 1].$$

Remark 3. A sequence $s = (\lambda_n)_{n \in \mathbb{N}}$, with $\lambda_0 = 1$ and $0 < \lambda_n < \frac{1}{p+1}$, for all $n \geq 1$, determines and is determined by a unique p -central Cantor set $\Lambda(p, s)$.

We have the following

Theorem 1 *Let $\Lambda(p, s) \subset [0, 1]$ be a p -central Cantor set ($p \geq 1$) which is determined by a sequence $s = (\lambda_n)_{n \in \mathbb{N}}$ as in Definition 2. Suppose that $\lim_{n \rightarrow \infty} \lambda_n = \lambda \neq 0$ and that there are $r, n_0 \in \mathbb{N}$ such that, for all $n \geq n_0$, the following conditions hold:*

- (1) $|\frac{1}{\lambda_n} - \frac{1}{\lambda}| < 2^{-\frac{r(n+1)}{2}} (\prod_{i=1}^n \lambda_i)^r$;
- (2) $|\frac{1}{\lambda_n} \frac{1-(p+1)\lambda_n}{(1-(p+1)\lambda_{n+1})} - \frac{1}{\lambda}| < 2^{-\frac{r(n+1)}{2}} (\frac{1-(p+1)\lambda_{n+1}}{p})^r (\prod_{i=1}^n \lambda_i)^r$.

Then $\Lambda(p, s)$ is a C^r -regular Cantor set.

We give the proof of Theorem 1 in paragraph five.

Next we have the following two corollaries:

Corollary 1 *Let $\Lambda(p, s) \subset [0, 1]$ be a p -central Cantor set determined by a sequence $s = (\lambda_n)_{n \in \mathbb{N}}$ as in Definition 2. Suppose that $\lim_{n \rightarrow \infty} \lambda_n = \lambda \neq 0$, and that there is $n_0 \in \mathbb{N}$ such that, for all $n \geq n_0$, the following conditions hold:*

- (1) $|\frac{1}{\lambda_n} - \frac{1}{\lambda}| < 2^{-\frac{n(n+1)}{2}} (\prod_{i=1}^n \lambda_i)^n$;
- (2) $|\frac{1}{\lambda_n} \frac{(1-(p+1)\lambda_n)}{(1-(p+1)\lambda_{n+1})} - \frac{1}{\lambda}| < 2^{-\frac{n(n+1)}{2}} (\frac{1-(p+1)\lambda_{n+1}}{p})^n (\prod_{i=1}^n \lambda_i)^n$.

Then $\Lambda(p, s)$ is a C^∞ -regular central Cantor set.

Corollary 2 *Let $\Lambda(p, s) \subset [0, 1]$ be a p -central Cantor set determined by*

a sequence of real numbers $s = (\lambda_n)_{n \in \mathbb{N}}$ as in Definition 2. Suppose s is increasing and satisfies: $0 < \lambda_n < \frac{1}{p+1}$, for all $n \geq 1$, $\lim_{n \rightarrow \infty} \lambda_n = \lambda$, $0 < \lambda < \frac{1}{p+1}$, and $|\frac{1}{\lambda_n} - \frac{1}{\lambda}| < 2^{-\frac{r(r+1)}{2}} \lambda_1^{(n+t)r}$ where t satisfies $\lambda_1^{tr} (\frac{p+1}{1-(p+1)\lambda} + 1) < (\frac{1-(p+1)\lambda}{p})^r$. Then $\Lambda(p, s)$ is a C^r -regular Cantor set.

Theorem 2 Let $\Lambda(p, s) \subset [0, 1]$ be a p -central Cantor set as in Theorem 1. Assume that the sequence $s = (\lambda_n)_{n \in \mathbb{N}}$ is increasing and satisfies the following conditions:

- (1) $0 < \lambda_n < \frac{1}{2p+1}$, $n \geq 1$;
- (2) $\sum_{i=1}^{\infty} \log((2p+1)\lambda_i)$ converges.

Then $\Lambda(p, s) - \Lambda(p, s)$ is a Cantor set of positive Lebesgue measure.

3. Basic Notations and Main Lemma

We first give the basic construction necessary to prove Theorem 1 for the case $p = 1$; here we denote $\Lambda(p, s)$ by $\Lambda(s)$. For the case $p \geq 2$, the proof of Theorem 1 follows from similar arguments.

Let $\Lambda(s)$ be the central Cantor set determined by a sequence of real numbers $s = (\lambda_n)_{n \in \mathbb{N}}$, with $\lambda_0 = 1$ and $0 < \lambda_n < \frac{1}{2}$, for $n = 1, 2, \dots$. We set $I_1 = I_1^1 = [0, \lambda_1]$, $I_2 = I_2^1 = [1 - \lambda_1, 1]$, and $I^1 = I_1^1 \cup I_2^1$. We wish to construct a surjective map $f : I^1 \rightarrow I$ which is monotone on each connected component of I^1 and such that $\Lambda = \bigcap_{n=0}^{\infty} f^{-n}(I)$. Also, for each $n \in \mathbb{N}$, we impose the condition $f^{-n}(I) = I^n$ (see Definition 2). The map f will be obtained as the limit of a sequence of maps $g_n : I^1 \rightarrow I$. In order to define the sequence of maps $(g_n)_{n \in \mathbb{N}}$ we need some notations.

Let R be the rectangle $[x_1, x_2] \times [y_1, y_2]$. Let $0 < \alpha < \frac{1}{2}$ and $0 < \beta < \frac{1}{2}$. We set $R_1(R, \alpha, \beta) = [x_1, x_1 + \alpha(x_2 - x_1)] \times [y_1, y_1 + \beta(y_2 - y_1)]$, $R_2(R, \alpha, \beta) = [x_2 - \alpha(x_2 - x_1), x_2] \times [y_2 - \beta(y_2 - y_1), y_2]$, and $L(R, \alpha, \beta) = [x_1 + \alpha(x_2 - x_1), x_2 - \alpha(x_2 - x_1)] \times [y_1 + \beta(y_2 - y_1), y_2 - \beta(y_2 - y_1)]$ (see Figure 1).

Now, for each $n \in \mathbb{N}$, let Δ_n denote the set of sequences of 1's and 2's of length n . For $\gamma \in \Delta_n$, we inductively define rectangles R_γ^n and L_γ . Set $R_1^1 = [0, \lambda_1] \times I$, and $R_2^1 = [1 - \lambda_1, 1] \times I$. Next assume that, for all $\gamma \in \Delta_n$, we have defined the rectangles R_γ^n and L_γ . We now set $R_{\gamma_1}^{n+1} = R_1(R_\gamma^n, \lambda_{n+1}, \lambda_n)$, $R_{\gamma_2}^{n+1} = R_2(R_\gamma^n, \lambda_{n+1}, \lambda_n)$, and $L_\gamma = L(R_\gamma^n, \lambda_{n+1}, \lambda_n)$.

Let $\pi_1 : [0, 1] \times [0, 1] \rightarrow [0, 1]$ be the projection given by $\pi_1(x, y) = x$. For $\gamma \in \Delta_n$, define $I_\gamma^n = \pi_1(R_\gamma^n)$; note that $I^n = \bigcup_{\gamma \in \Delta_n} I_\gamma^n$.

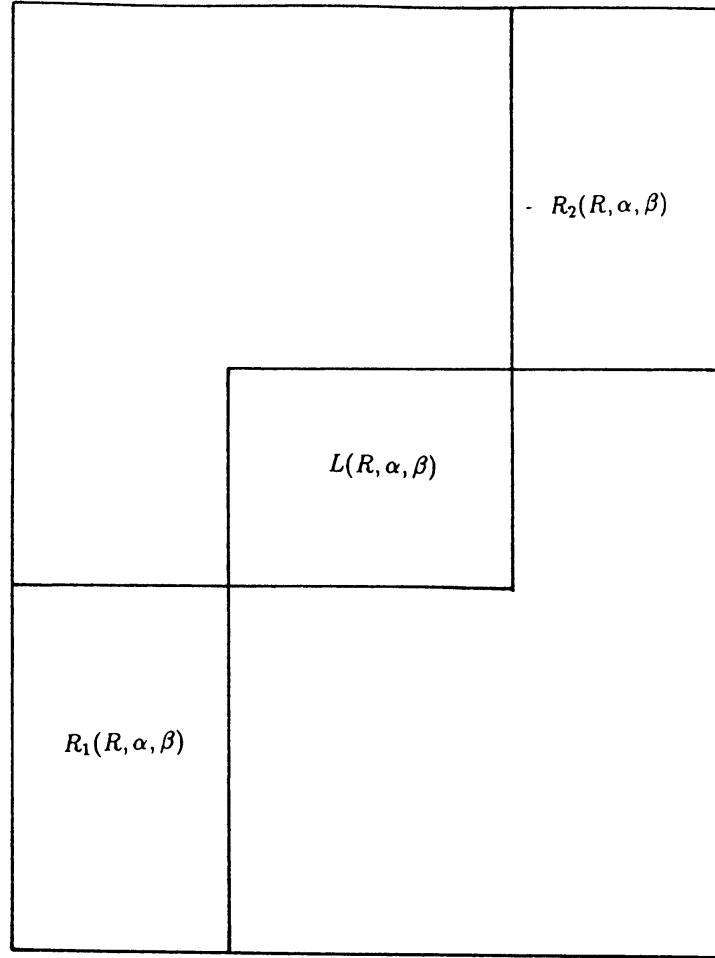

Fig. 1.

We may now define the following sequence of maps $(g_n)_{n \in \mathbb{N}}$:

1. Let $g_1 : I_1 \cup I_2 \rightarrow I$ be strictly monotone and continuous on each connected component I_1^1 and I_2^1 of I^1 , and such that the end points of the graphics of $g_1|_{I_1^1}$ and $g_1|_{I_2^1}$ are vertices of the rectangles R_1^1 and R_2^1 , respectively. Clearly, $g^{-1}(I) = I^1 = I_1^1 \cup I_2^1$.

2. In order to define $g_2 : I_1^1 \cup I_2^1 \rightarrow I$ we proceed as follows. Let $\gamma \in \Delta_1$ and define $g_2 : I_1^1 \cup I_2^1 \rightarrow I$ to be strictly monotone and continuous on each connected component I_1^1 and I_2^1 of I^1 , such that its graphic is contained in the union of the rectangles $R_{\gamma 1}^2$, L_γ , and $R_{\gamma 2}^2$, and passing through two vertices of each one of these rectangles. It is clear that $g_2^{-1}(I) = I^1$ and that $g^{-2}(I) = I^2$.

3. Next we define $g_3 : I_1^1 \cup I_2^1 \rightarrow I$ by redefining g_2 on the intervals I_β^2 , $\beta \in \Delta_2$. On each interval I_β^2 , $\beta \in \Delta_2$, define g_3 the same way as in

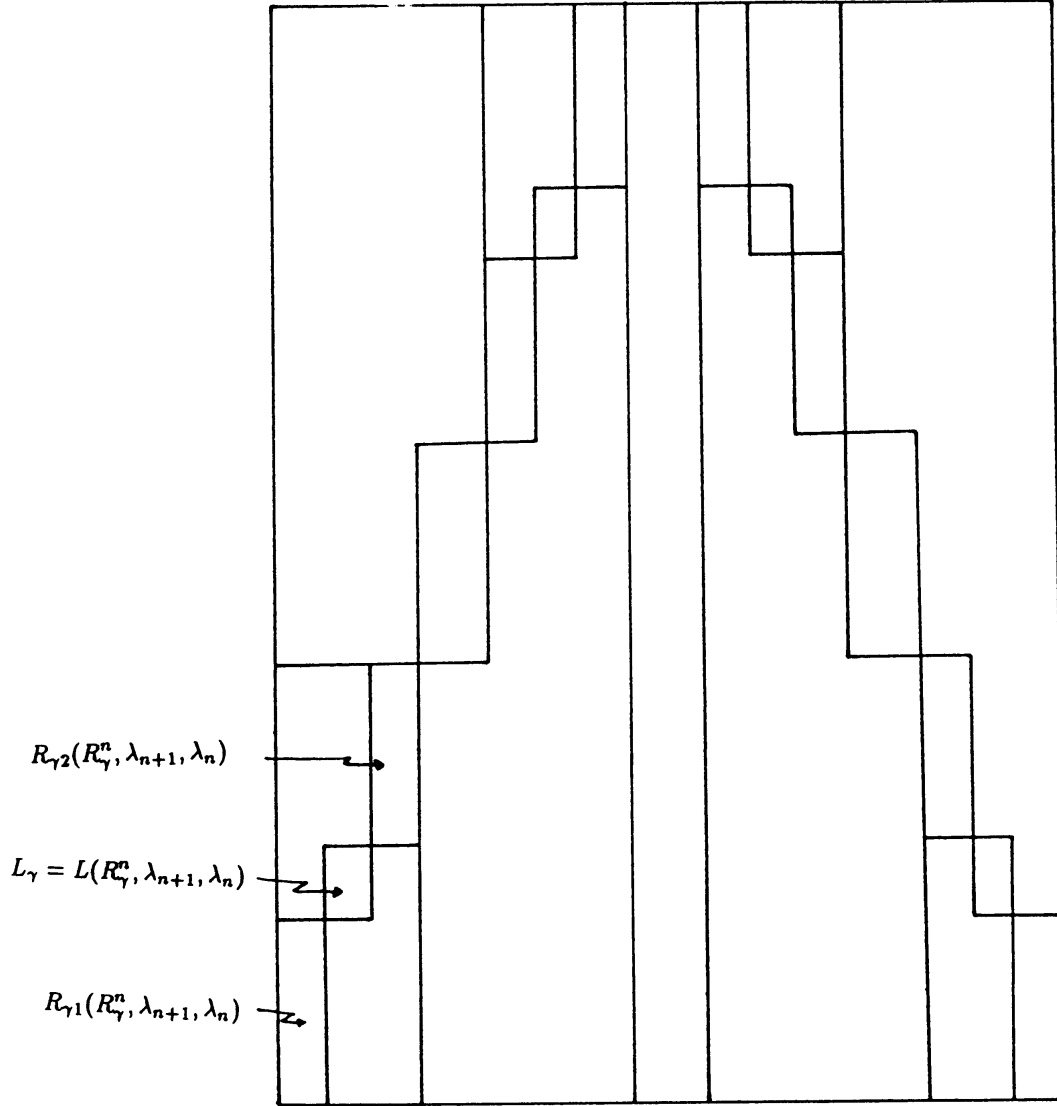

Fig. 2.

step 2 above, only now changing the rectangles $R_{\gamma_1}^2$, L_γ and $R_{\gamma_2}^2$ by the rectangles $R_{\beta_1}^3$, L_β and $R_{\beta_2}^3$, respectively. We thus obtain a map g_3 which is strictly monotone and continuous, and such that: $g_3|_{(I^1-I^2)} \equiv g_2|_{(I^1-I^2)}$, $g_3^{-1}(I) = I^1$, $g_3^{-2}(I) = I^2$ and $g_3^{-3}(I) = I^3$.

4. Suppose we have defined $g_n : I^1 \rightarrow I$ to be strictly monotone and continuous on each connected component I_1^1 and I_2^1 of I^1 , and such that the graphic of g_n contains two vertices of each rectangle R_γ^n , $\gamma \in \Delta_n$. Define $g_{n+1} : I^1 \rightarrow I$ by simply changing the definition of g_n on $\pi_1(R_\gamma^n)$, $\gamma \in \Delta_n$, the same way as in step 3. We thus obtain a map g_{n+1} which is strictly monotone and continuous on each connected component of I^1 , and such

*g₁*

Fig. 3. (a)

*g₂*

Fig. 3. (b)

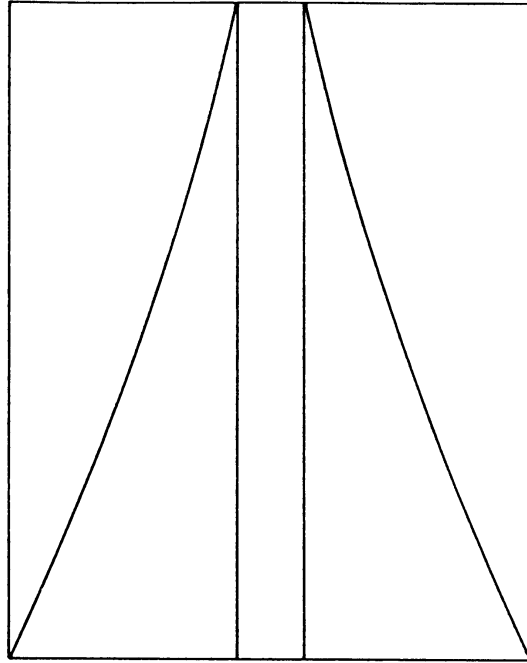

 g_3

Fig. 3. (c)

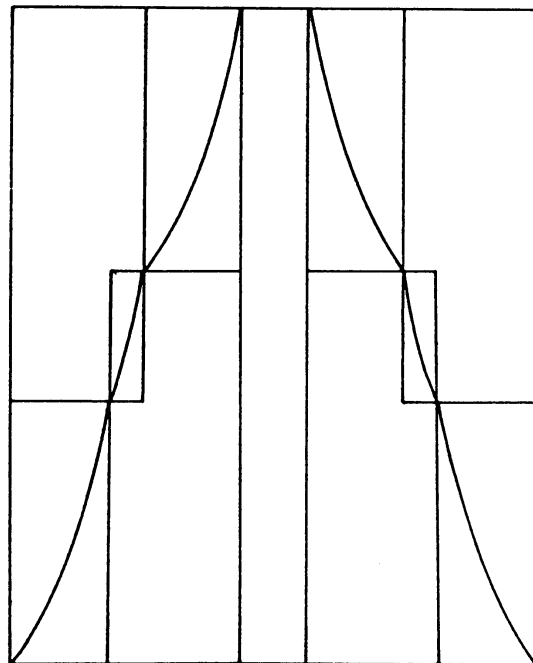
that its graphic contains two vertices of each rectangle R_γ^{n+1} , $\gamma \in \Delta_{n+1}$; furthermore, $g_{n+1}|_{(I^1-I^n)} \equiv g_n|_{(I^1-I^n)}$. It is clear that $g_{n+1}^{-i}(I) = I^i$, $i = 1, \dots, n+1$.

Remark 4.

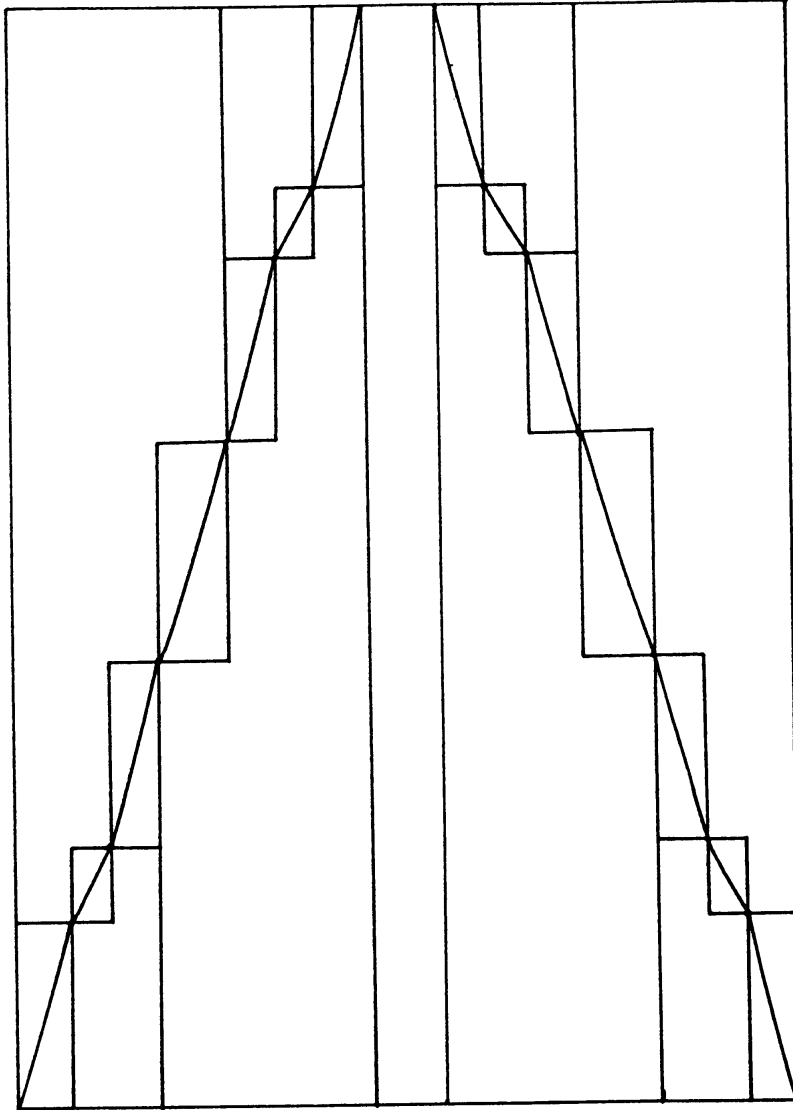
1. Since, for all $n \in \mathbb{N}$, $g_{n+1}|_{(I^1-I^n)} \equiv g_n|_{(I^1-I^n)}$, we conclude that the sequence $(g_n)_{n \in \mathbb{N}}$ converges uniformly on $I^1 - I^n$. Since the length of I_j^n is $\prod_{i=1}^n \lambda_i$, and since $\lim_{n \rightarrow \infty} \prod_{i=1}^n \lambda_i$ is zero, we have defined $f = \lim_{n \rightarrow \infty} g_n$, $f : I^1 \rightarrow I$, which is strictly monotone and continuous. It is clear that $\Lambda = \bigcap_{n=1}^{\infty} f^{-n}(I)$.

2. A point $x \in \Lambda$ will be called *border point* if x is an end point of I_j^n , some j and n .

Assume that f is defined as above and of class C^r , $r \geq 2$. Let x be a border point. Then

$$f'(x) = \lim_{n \rightarrow \infty} \frac{\prod_{i=1}^n \lambda_i}{\prod_{i=1}^{n+1} \lambda_i} = \lim_{n \rightarrow \infty} \frac{1}{\lambda_{n+1}} = \frac{1}{\lambda}$$

and, consequently, for all $x \in \Lambda$, we have that $f'(x) = \frac{1}{\lambda}$ and that $f^{(i)}(x) = 0$, for any $i = 2, \dots, r$.

For the proof of Theorem 1 we need the following

Main Lemma *Let $r \in \mathbb{N}$. Let $a > 0$ and $0 < \varepsilon < 1$. If x and y satisfy*

(i) $0 < x < \varepsilon$,

(ii) $|y - ax| < 2^{-\frac{r(r+1)}{2}} x^{r+1}$,

then there exists a C^∞ -function $h : [0, x] \rightarrow \mathbb{R}$ such that:

(1) $h(0) = 0$, $h(x) = y - ax$,

(2) $h^{(i)}(0) = h^{(i)}(x) = 0$, for any $1 \leq i \leq r$,

(3) $|h^{(i)}(t)| < \varepsilon$, for any $1 \leq i \leq r$ and $0 \leq t \leq x$.

We begin the proof of the Main Lemma in paragraph four after the proof of Lemma 6.

Remark 5.

1) Under its conditions, the Main Lemma guarantees that we may construct a C^∞ map $g : [0, x] \rightarrow [0, y]$ whose graphic has slope a at both 0 and x , and that its first r derivatives are bounded by ε (see Figure 4).

We use this fact to define the sequence of maps $(g_n)_{n \in \mathbb{N}}$.

2) Assume that $s = (\lambda_n)_{n \in \mathbb{N}}$ satisfies the conditions of Theorem 1. Let $a = \frac{1}{\lambda}$. If x and y denote the sides of the rectangle R_γ^n , $\gamma \in \Delta_n$, $n \geq 1$, then $x = \prod_{i=0}^n \lambda_i$, $y = \prod_{i=0}^{n-1} \lambda_i$, and $|y - ax| < 2^{-\frac{r(r+1)}{2}} x^{r+1}$. Similarly, if x and y denote the sides of the rectangle L_γ^n , $\gamma \in \Delta_n$, $n \geq 2$, then $x = (1 - 2\lambda_{n+1}) \prod_{i=0}^n \lambda_i$, $y = (1 - 2\lambda_n) \prod_{i=0}^{n-1} \lambda_i$, and $|y - ax| < 2^{-\frac{r(r+1)}{2}} x^{r+1}$. We conclude that the Main Lemma may be applied to both rectangles R_γ^n and L_γ^n , $n \in \mathbb{N}$ large enough.

In the general case, for the rectangles R_γ^n , we apply the Main Lemma with $x = \prod_{i=1}^n \lambda_i$ and $y = \prod_{i=1}^{n-1} \lambda_i$, and for the rectangles L_γ^n it is applied with $x = \frac{(1-(p+1)\lambda_{n+1})}{p} \prod_{i=1}^n \lambda_i$ and $y = \frac{(1-(p+1)\lambda_n)}{p} \prod_{i=1}^{n-1} \lambda_i$, $n \in \mathbb{N}$ large enough.

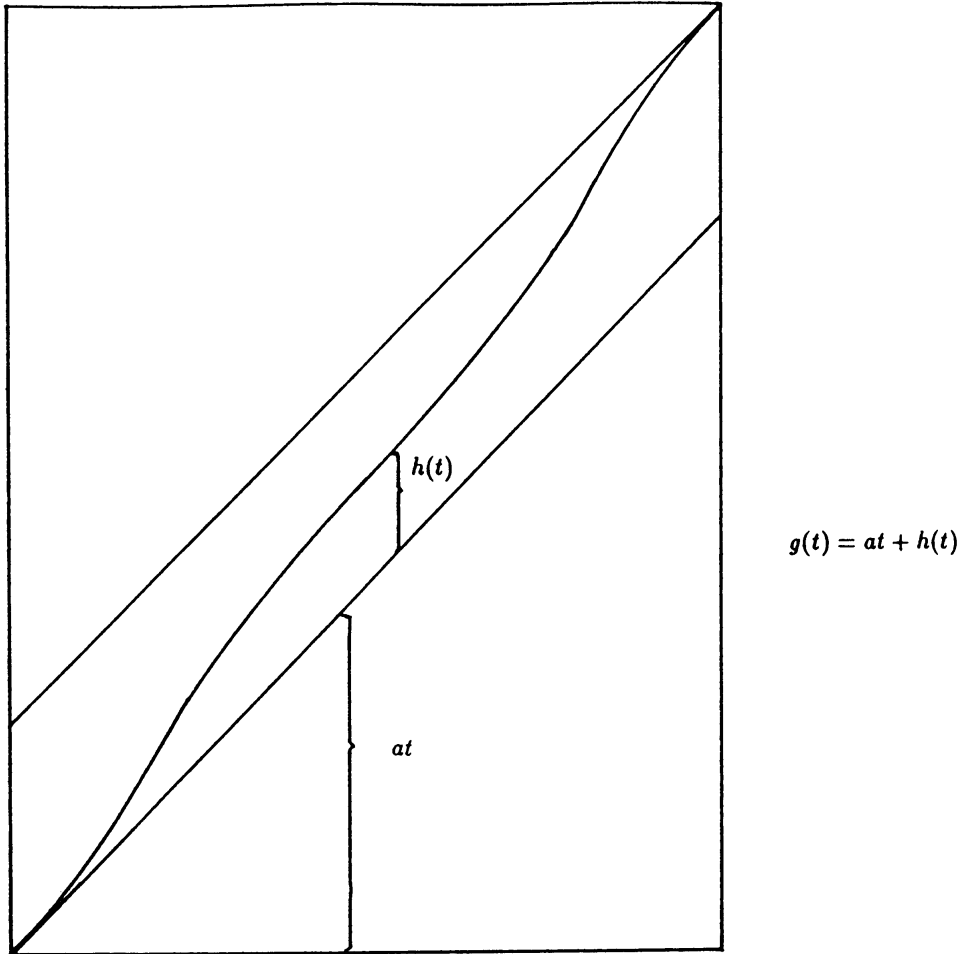

Fig. 4.

4. Proof of the Main Lemma

In order to prove the Main Lemma, we first define the r -times iteration of integration of functions and give five lemmas.

Let $f(t)$ be an integrable function on a closed interval $[a, b]$. We define

$$f^{[0]}(t) = f(t), \quad f^{[1]}(t) = \int_a^t f(s)ds \quad \text{and} \quad f^{[r+1]}(t) = \int_a^t f^{[r]}(s)ds.$$

Now let $r \in \mathbb{N}$. We define functions $w_r(t)$ on $[0, 2^r]$ by

$$w_0(t) = 1, \quad 0 \leq t \leq 1$$

and

$$w_{r+1}(t) = \begin{cases} w_r(t), & 0 \leq t \leq 2^r \\ -w_r(t - 2^r), & 2^r \leq t \leq 2^{r+1}. \end{cases}$$

With the above notation we have the following

Lemma 2

(1) For any $r \geq 1$ and $0 \leq i \leq r - 1$,

$$w_r^{[i]}(t) = \begin{cases} w_{r-1}^{[i]}(t), & 0 \leq t \leq 2^{r-1} \\ -w_{r-1}^{[i]}(t - 2^{r-1}), & 2^{r-1} \leq t \leq 2^r. \end{cases}$$

(2) For any $r \geq 1$ and $1 \leq i \leq j \leq r$, $w_r^{[i]}(2^j) = 0$.

(3) For any $r \geq 1$ and $0 \leq t \leq 2^{r-1}$, $w_r^{[r]}(t + 2^{r-1}) = 2^{\frac{(r-1)(r-2)}{2}} - w_r^{[r]}(t)$.

(4) For any $r \geq 1$, $w_r^{[r+1]}(2^r) = 2^{\frac{r(r-1)}{2}}$.

Proof. (1) By induction on r we prove the statement and that $w_r^{[j]}(2^{r-1}) = 0$, for all $1 \leq j \leq r - 1$.

First we note that, for any r , case $i = 0$ is precisely the definition of w_r . Thus we may assume that $i \geq 1$.

(i) Case $r = 1$. Then $i = 0$ and, as we pointed out above, we are done.

On the other hand, there are no $j \geq 1$ such that $1 \leq j \leq r - 1$.

(ii) Case $r = 2$. Then i may be 0 or 1, and $j = 1$.

For $i = 1$ we have: if $0 \leq t \leq 2$, then

$$w_2^{[1]}(t) = \int_0^t w_2(s) ds = \int_0^t w_1(s) ds = w_1^{[1]}(t);$$

and if $2 \leq t \leq 2^2$, then

$$\begin{aligned} w_2^{[1]}(t) &= \int_0^t w_2(s) ds = \int_0^2 w_2(s) ds + \int_2^t w_2(s) ds \\ &= w_2^{[1]}(2) - \int_2^t w_1(s - 2) ds = w_2^{[1]}(2) - \int_0^{t-2} w_1(u) du \\ &= w_2^{[1]}(2) - w_1^{[1]}(t - 2). \end{aligned}$$

Now, for $j = 1$, we have

$$w_2^{[1]}(2) = \int_0^2 w_2(s) ds = \int_0^2 w_1(s) ds$$

$$= \int_0^1 w_0(s)ds - \int_1^2 w_0(s-1)ds = 0.$$

Therefore

$$w_2^{[1]}(t) = \begin{cases} w_1^{[1]}(t), & 0 \leq t \leq 2 \\ -w_1^{[1]}(t-2), & 2 \leq t \leq 2^2. \end{cases}$$

By induction we now assume that the statement is true for all $2 \leq k \leq r-1$; we prove that it is true for $k=r$. For this we make induction over i and j .

Case $i=1$. If $0 \leq t \leq 2^{r-1}$, then

$$w_r^{[1]}(t) = \int_0^t w_r(s)ds = \int_0^t w_{r-1}(s)ds = w_{r-1}^{[1]}(t);$$

now if $2^{r-1} \leq t \leq 2^r$, then

$$\begin{aligned} w_r^{[1]}(t) &= \int_0^t w_r(s)ds = \int_0^{2^{r-1}} w_{r-1}(s)ds - \int_{2^{r-1}}^t w_{r-1}(s-2^{r-1})ds \\ &= w_{r-1}^{[1]}(2^{r-1}) - \int_0^{t-2^{r-1}} w_{r-1}(u)du \\ &= w_{r-1}^{[1]}(2^{r-1}) - w_{r-1}^{[1]}(t-2^{r-1}). \end{aligned}$$

We next must prove that $w_{r-1}^{[1]}(2^{r-1}) = 0$. We have

$$\begin{aligned} w_{r-1}^{[1]}(2^{r-1}) &= \int_0^{2^{r-1}} w_{r-1}(s)ds \\ &= \int_0^{2^{r-2}} w_{r-2}(s)ds - \int_{2^{r-2}}^{2^{r-1}} w_{r-2}(s-2^{r-2})ds \\ &= \int_0^{2^{r-2}} w_{r-2}(s)ds - \int_0^{2^{r-2}} w_{r-2}(s)ds = 0, \end{aligned}$$

thus $w_r^{[1]}(t) = -w_{r-1}^{[1]}(t-2^{r-1})$. Therefore

$$w_r^{[1]}(t) = \begin{cases} w_{r-1}^{[1]}(t), & 0 \leq t \leq 2^{r-1} \\ -w_{r-1}^{[1]}(t-2^{r-1}), & 2^{r-1} \leq t \leq 2^r. \end{cases}$$

By induction we now suppose that

$$w_r^{[\ell]}(t) = \begin{cases} w_{r-1}^{[\ell]}(t), & 0 \leq t \leq 2^{r-1} \\ -w_{r-1}^{[\ell]}(t - 2^{r-1}), & 2^{r-1} \leq t \leq 2^r, \end{cases}$$

for all ℓ , with $1 \leq \ell \leq i \leq r - 1$.

If $0 \leq t \leq 2^{r-1}$, we have

$$w_r^{[i+1]} = \int_0^t w_r^{[i]}(s) ds = \int_0^t w_{r-1}^{[i]}(s) ds = w_{r-1}^{[i+1]}(t);$$

and if $2^{r-1} \leq t \leq 2^r$, then

$$\begin{aligned} w_r^{[i+1]}(t) &= \int_0^t w_r^{[i]}(s) ds = \int_0^{2^{r-1}} w_r^{[i]}(s) ds + \int_{2^{r-1}}^t w_r^{[i]}(s) ds \\ &= w_r^{[i+1]}(2^{r-1}) - \int_{2^{r-1}}^t w_{r-1}^{[i]}(s - 2^{r-1}) ds \\ &= w_r^{[i+1]}(2^{r-1}) - \int_0^{t-2^{r-1}} w_{r-1}^{[i]}(s) ds \\ &= w_r^{[i+1]}(2^{r-1}) - w_{r-1}^{[i+1]}(t - 2^{r-1}). \end{aligned}$$

It remains to see that $w_r^{[i+1]}(2^{r-1}) = 0$. For this we prove that if $1 \leq j+1 \leq i+1$, then $w_r^{[j+1]}(2^{r-1}) = 0$. In fact let $0 \leq j \leq i$. Then

$$\begin{aligned} w_r^{[j+1]}(2^{r-1}) &= \int_0^{2^{r-1}} w_r^{[j]}(s) ds = \int_0^{2^{r-1}} w_{r-1}^{[j]}(s) ds \\ &= \int_0^{2^{r-2}} w_{r-1}^{[j]}(s) ds - \int_{2^{r-2}}^{2^{r-1}} w_{r-1}^{[j]}(s - 2^{r-2}) ds \\ &= \int_0^{2^{r-2}} w_{r-1}^{[j]}(s) ds - \int_0^{2^{r-2}} w_{r-1}^{[j]}(s) ds = 0. \end{aligned}$$

The latter completes the induction step. Therefore

$$w_r^{[i]}(t) = \begin{cases} w_{r-1}^{[i]}(t), & 0 \leq t \leq 2^{r-1} \\ -w_{r-1}^{[i]}(t - 2^{r-1}), & 2^{r-1} \leq t \leq 2^r, \end{cases}$$

and $w_r^{[j]}(2^{r-1}) = 0$, for all $1 \leq j \leq i+1$. Since $i \leq r-2$ and $j \leq i+1$, we have $j \leq r-1$ which completes the proof of the statement.

Concerning (2), let $1 \leq i \leq j \leq r$; we have three possibilities:

(i) If $j = r$, we have

$$\begin{aligned} w_r^{[i]}(2^r) &= \int_0^{2^r} w_r^{[i-1]}(s) ds \\ &= \int_0^{2^{r-1}} w_{r-1}^{[i-1]}(s) ds - \int_{2^{r-1}}^{2^r} w_{r-1}^{[i-1]}(s - 2^{r-1}) ds \\ &= \int_0^{2^{r-1}} w_{r-1}^{[i-1]}(s) ds - \int_0^{2^{r-1}} w_{r-1}^{[i-1]}(s) ds = 0. \end{aligned}$$

(ii) If $j = r - 1$, then $w_r^{[i]}(2^{r-1}) = 0$ as was proved above as part of the proof of statement (1).

(iii) Finally if $j = r - \ell \geq i > 1$, we consider powers of 2 ordered as follows: $2^r > 2^{r-1} > \dots > 2^{r-(\ell-1)}$. Note that $i \leq j = r - \ell < r - (\ell - 1) < \dots < r$, and apply the above formula to obtain $w_r^{[i]}(2^j) = w_r^{[i]}(2^{r-\ell}) = w_{r-1}^{[i]}(2^{r-\ell}) = w_{r-2}^{[i]}(2^{r-\ell}) = \dots = w_{r-(\ell-1)}^{[i]}(2^{r-\ell}) = 0$.

As for (3) by induction on r we have that, for $r = 1$,

$$\begin{aligned} w_1^{[1]}(t+1) &= \int_0^{t+1} w_1(s) ds = \int_0^1 w_1(s) ds + \int_1^{t+1} w_1(s) ds \\ &= \int_0^1 ds - \int_1^{t+1} ds = 1 - t = 2^{\frac{(r-1)(r-2)}{2}} - w_1^{[1]}(t). \end{aligned}$$

By induction we now assume that $w_\ell^{[\ell]}(t + 2^{\ell-1}) = 2^{\frac{(\ell-1)(\ell-2)}{2}} - w_\ell^{[\ell]}(t)$, for any $0 \leq t \leq 2^{\ell-1}$ and $1 \leq \ell \leq r$. Then, for $r + 1$, we have

$$\begin{aligned} w_{r+1}^{[r+1]}(t + 2^r) &= \int_0^{t+2^r} w_{r+1}^{[r]}(s) ds \\ &= \int_0^{2^r} w_r^{[r]}(s) ds - \int_{2^r}^{t+2^r} w_r^{[r]}(s - 2^r) ds \\ &= w_r^{[r+1]}(2^r) - \int_0^t w_{r+1}^{[r]}(u) du \\ &= w_r^{[r+1]}(2^r) - w_{r+1}^{[r+1]}(t). \end{aligned}$$

Since

$$\begin{aligned} w_r^{[r+1]}(2^r) &= \int_0^{2^r} w_r^{[r]}(s) ds \\ &= \int_0^{2^{r-1}} w_r^{[r]}(s) ds + \int_{2^{r-1}}^{2^{r-1}+2^{r-1}} w_r^{[r]}(s) ds, \end{aligned}$$

setting $s = t + 2^{r-1}$ in the latter integral we obtain

$$\begin{aligned} w_r^{[r+1]}(2^r) &= \int_0^{2^{r-1}} w_r^{[r]}(s) ds + \int_0^{2^{r-1}} w_r^{[r]}(s + 2^{r-1}) ds \\ &= \int_0^{2^{r-1}} w_r^{[r]}(s) ds + \int_0^{2^{r-1}} \left(2^{\frac{(r-1)(r-2)}{2}} - w_r^{[r]}(s) \right) ds \\ &= 2^{\frac{(r-1)(r-2)}{2}} 2^{r-1} = 2^{\frac{r(r-1)}{2}}. \end{aligned}$$

which completes the proof of statement (2). \square

The proof of statement (4) is contained in the last part of statement (3) and thus the proof of the lemma is now complete.

We next define the function $k_r(t)$ by rescaling $w_r(t)$ from $[0, 2^r]$ to $[0, x]$,

$$k_r(t) = w_r \left(\frac{2^r}{x} t \right).$$

By Lemma 2 above and $(r + 1)$ -times rescaling in integration we obtain

$$k_r^{[r+1]}(x) = 2^{-\frac{r(r+3)}{2}} x^{r+1}.$$

For this, by induction on r , we prove that

$$k_r^{[i]}(t) = \frac{x^i}{2^{2i}} w_r^{[i]} \left(\frac{2^r t}{x} \right),$$

for any $1 \leq i \leq r + 1$.

In fact for $r = 1$ and $r = 2$, we have:

$$\begin{aligned} k_r^{[1]}(t) &= \int_0^t k_r(s) ds = \int_0^t w_r \left(\frac{2^r s}{x} \right) ds = \frac{x}{2^r} \int_0^{\frac{2^r t}{x}} w_r(u) du \\ &= \frac{x}{2^r} w_r^{[1]} \left(\frac{2^r t}{x} \right), \\ k_r^{[2]}(t) &= \int_0^t k_r^{[1]}(s) ds = \frac{x}{2^r} \int_0^t w_r^{[1]} \left(\frac{2^r s}{x} \right) ds = \frac{x^2}{2^{2r}} \int_0^{\frac{2^r t}{x}} w_r^{[1]}(u) du \\ &= \frac{x^2}{2^{2r}} w_r^{[2]} \left(\frac{2^r t}{x} \right). \end{aligned}$$

By induction we assume that

$$k_r^{[\ell]}(t) = \frac{x^\ell}{2^{2\ell}} w_r^{[\ell]} \left(\frac{2^r t}{x} \right),$$

for any $2 \leq \ell \leq r$. Next for $r + 1$, we have

$$\begin{aligned} k_r^{[r+1]}(t) &= \int_0^t k_r^{[r]}(s) ds = \frac{x^r}{2^{2r}} \int_0^t w_r^{[r]} \left(\frac{2^r s}{x} \right) ds \\ &= \frac{x^{r+1}}{2^{2(r+1)}} \int_0^{\frac{2^r t}{x}} w_r^{[r]}(u) du = \frac{x^{r+1}}{2^{2(r+1)}} w_r^{[r+1]} \left(\frac{2^r t}{x} \right). \end{aligned}$$

Now if we set $t = x$ in the above formula and using that $w_r^{[r+1]}(2^r) = 2^{\frac{(r-1)(r-2)}{2}}$, we obtain

$$k_r^{[r+1]}(x) = x^{r+1} \cdot 2^{-\frac{r(r+3)}{2}}.$$

Concerning the maximum values of $|k_r^{[i]}(t)|$, for $1 \leq i \leq r + 1$ and $0 \leq t \leq x$, we have the following four lemmas.

Lemma 3 For $r \geq 1$ and $0 \leq t \leq 2^{r-1}$, $w_r^{[r-1]}(t) \geq 0$.

Proof. We make induction on $r \geq 1$. For $r = 1$ and $r = 2$, the statement is an easy computation.

By induction assume that $w_{r-1}^{[r-2]}(t) \geq 0$, for any $r \geq 3$ and all $0 \leq t \leq 2^{r-2}$.

We have two cases to consider:

- (i) $0 \leq t \leq 2^{r-2}$ and
- (ii) $2^{r-2} \leq t \leq 2^{r-1}$.

Case (i). We have

$$w_r^{[r-1]}(t) = \int_0^t w_r^{[r-2]}(s) ds = \int_0^t w_{r-1}^{[r-2]}(s) ds \geq 0.$$

Case (ii). Since $0 \leq t - 2^{r-2} \leq 2^{r-2} \leq 2^{r-1}$, we have that

$$\begin{aligned} w_r^{[r-1]}(t) &= \int_0^t w_r^{[r-2]}(s) ds = \int_0^{t-2^{r-2}} w_r^{[r-2]}(s) ds \\ &\quad + \int_{t-2^{r-2}}^{2^{r-2}} w_r^{[r-2]}(s) ds + \int_{2^{r-2}}^t w_r^{[r-2]}(s) ds \\ &= \int_0^{t-2^{r-2}} w_{r-1}^{[r-2]}(s) ds + \int_{t-2^{r-2}}^{2^{r-2}} w_r^{[r-2]}(s) ds \\ &\quad + \int_{2^{r-2}}^t w_{r-1}^{[r-2]}(s) ds \end{aligned}$$

$$\begin{aligned}
&= \int_0^{t-2^{r-2}} w_{r-2}^{[r-2]}(s) ds + \int_{t-2^{r-2}}^{2^{r-2}} w_r^{[r-2]}(s) ds \\
&\quad - \int_{2^{r-2}}^t w_{r-2}^{[r-2]}(s - 2^{r-2}) ds \\
&= \int_0^{t-2^{r-2}} w_{r-2}^{[r-2]}(s) ds + \int_{t-2^{r-2}}^{2^{r-2}} w_r^{[r-2]}(s) ds \\
&\quad - \int_0^{t-2^{r-2}} w_{r-2}^{[r-2]}(u) du \\
&= \int_{t-2^{r-2}}^{2^{r-2}} w_r^{[r-2]}(s) ds = \int_{t-2^{r-2}}^{2^{r-2}} w_{r-1}^{[r-2]}(s) ds \geq 0.
\end{aligned}$$

□

Lemma 4 For $r \geq 1$ and $0 \leq t \leq 2^r$, we have that $w_r^{[r]}(t) \geq 0$ and $w_r^{[r]}(t)$ attains the maximum value $2^{\frac{(r-1)(r-2)}{2}}$ at $t = 2^{r-1}$.

Proof. If $0 \leq t \leq 2^{r-1}$, then $\frac{dw_r^{[r]}(t)}{dt} = w_r^{[r-1]}(t) \geq 0$. Hence $w_r^{[r]}(t)$ is increasing in $[0, 2^{r-1}]$ and, therefore, $0 = w_r^{[r]}(0) \leq w_r^{[r]}(t) \leq w_r^{[r]}(2^{r-1}) = 2^{\frac{(r-1)(r-2)}{2}}$.

If $2^{r-1} \leq t \leq 2^r$, then $\frac{dw_r^{[r]}(t)}{dt} = \frac{d}{dt}(2^{\frac{(r-1)(r-2)}{2}} - w_r^{[r]}(t - 2^{r-1})) = -w_r^{[r-1]}(t - 2^{r-1}) \leq 0$; hence $w_r^{[r]}(t)$ is decreasing in $[2^{r-1}, 2^r]$. Therefore

$$2^{\frac{(r-1)(r-2)}{2}} = w_r^{[r]}(2^{r-1}) \geq w_r^{[r]}(t) \geq w_r^{[r]}(0) = 0.$$

□

Lemma 5 For $r \geq 0$ and $1 \leq i \leq r+1$, the maximum value of $|w_r^{[i]}(t)|$ in $0 \leq t \leq 2^r$ is $2^{\frac{(i-1)(i-2)}{2}}$.

Proof. Since $\frac{dw_r^{[r+1]}(t)}{dt} = w_r^{[r]}(t) \geq 0$, $w_r^{[r+1]}(t)$ is increasing and by Lemma 4

$$\max_{t \in [0, 2^r]} |w_r^{[r+1]}(t)| = w_r^{[r+1]}(2^r) = 2^{\frac{r(r-1)}{2}}.$$

Again, by Lemma 4

$$\max_{t \in [0, 2^r]} |w_r^{[r]}(t)| = 2^{\frac{(r-1)(r-2)}{2}}.$$

Now suppose $i \leq r - 1$. Then

$$\begin{aligned} \max_{t \in [0, 2^r]} |w_r^{[i]}(t)| &= \max_{t \in [0, 2^{r-1}]} |w_{r-1}^{[i]}(t)| = \max_{t \in [0, 2^{r-2}]} |w_{r-2}^{[i]}(t)| = \cdots \\ &= \max_{t \in [0, 2^{r-(r-i)}]} |w_{r-(r-i)}^{[i]}(t)| = 2^{\frac{(i-1)(i-2)}{2}}. \end{aligned}$$

□

Lemma 6 For any $1 \leq i \leq r + 1$, and any $0 \leq t \leq x$, the maximum value of $|k_r^{[i]}(t)|$ is $x^i 2^{\frac{(i-1)(i-2)}{2} - ir}$.

Proof. Since $k_r^{[i]}(t) = \frac{x^i}{2^{ir}} w_r^{[i]}(\frac{2^r t}{x})$ and by Lemma 5, we have

$$\begin{aligned} \max_{0 \leq t \leq x} |k_r^{[i]}(t)| &= \max_{0 \leq t \leq x} \left| \frac{x^i}{2^{ir}} w_r^{[i]}\left(\frac{2^r t}{x}\right) \right| = \frac{x^i}{2^{ir}} \max_{0 \leq s \leq 2^r} |w_r^{[i]}(s)| \\ &= \frac{x^i}{2^{ir}} 2^{\frac{(i-1)(i-2)}{2}} = x^i 2^{\frac{(i-1)(i-2)}{2} - ir}. \end{aligned}$$

□

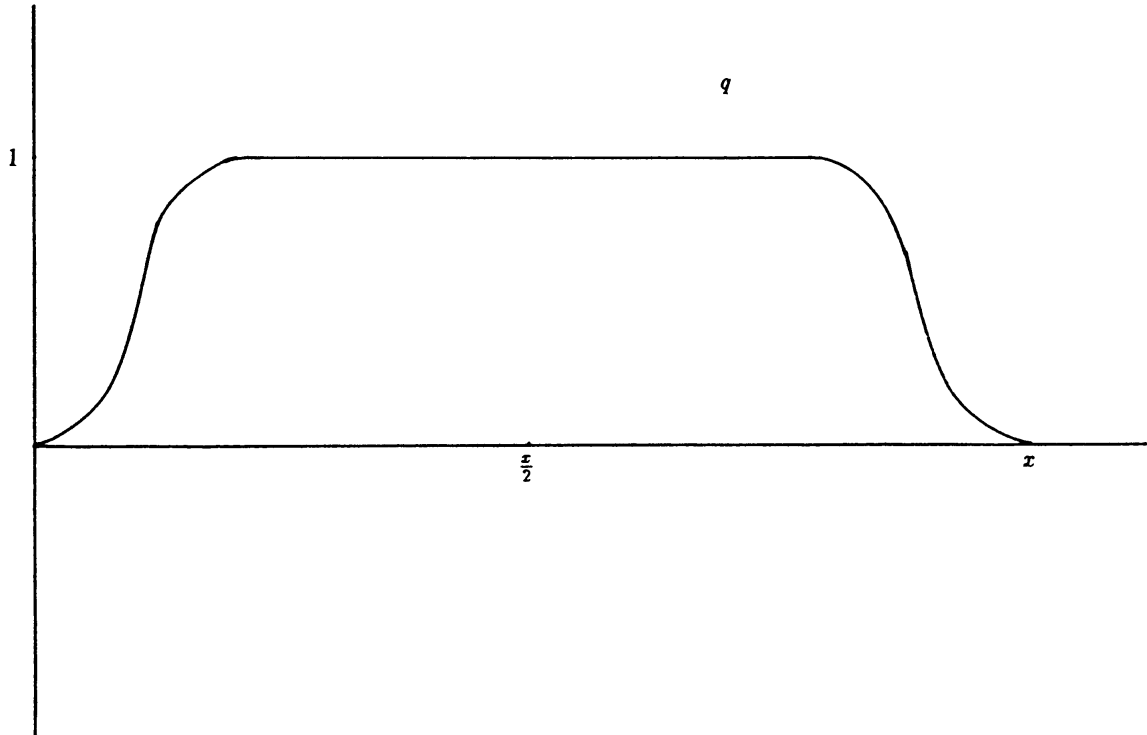

Fig. 5. (a)

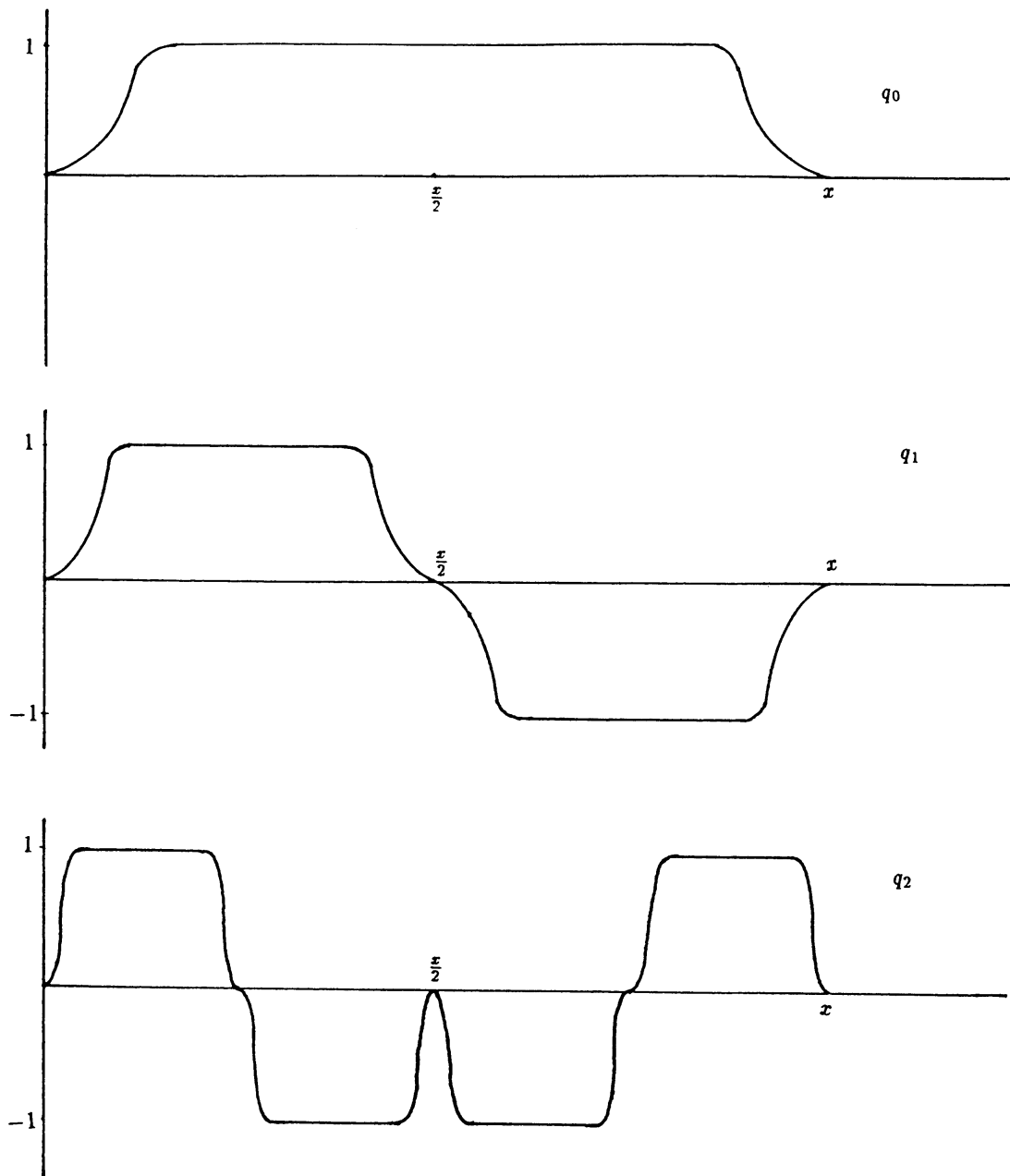

Fig. 5. (b)

We next begin the proof of the Main Lemma.

In order to define the function h we take a C^∞ bump function $q_0 : [0, x] \rightarrow [0, 1]$ such that $q_0 \equiv 1$ in a neighborhood V of $\frac{x}{2}$ and that $q_0 \equiv 0$ in some neighborhoods of 0 and x .

We define, inductively, a sequence of C^∞ maps $q_n : [0, x] \rightarrow [-1, 1]$ by

$$q_n(t) = \begin{cases} q_{n-1}(2t), & 0 \leq t \leq \frac{x}{2} \\ -q_{n-1}(2t - x), & \frac{x}{2} \leq t \leq x. \end{cases}$$

We now define the function h by

$$h(t) = \frac{y - ax}{q_r^{[r+1]}(x)} q_r^{[r+1]}(t).$$

Then it is clear that h is C^∞ , and that it satisfies $h(0) = 0$ and $h(x) = y - ax$; we thus have statement (1).

Concerning statement (2), it is clear that $h^{(i)}(0) = 0$, for any $1 \leq i \leq r$.

In order to prove $h^{(i)}(x) = 0$ we first note that

$$h^{(i)}(t) = \frac{y - ax}{q_r^{[r+1]}(x)} q_r^{[r+1-i]}(t).$$

Next note that if we prove $q_r^{[r+1-i]}(x) = 0$, the second part of statement (2) follows.

We have the following

Lemma 7

(1) For any $r \geq 1$ and $0 \leq i \leq r - 1$,

$$q_r^{[i]}(t) = \begin{cases} \frac{1}{2^i} q_{r-1}^{[i]}(2t), & 0 \leq t \leq \frac{x}{2} \\ -\frac{1}{2^i} q_{r-1}^{[i]}(2t - x), & \frac{x}{2} \leq t \leq x. \end{cases}$$

(2) $q_r^{[i]}(2^{j-r}x) = 0$, for any $r \geq 1$ and $1 \leq i \leq j \leq r$.

Proof. (1) By induction on r we prove the statement and the equality $q_r^{[i+1]}(\frac{x}{2}) = 0$.

First note that, for any $r \geq 1$, case $i = 0$ is precisely the definition of q_r .

We may thus assume that $i \geq 1$.

For $r = 1$, i may be 0 or 1.

For $i = 1$:

if $0 \leq t \leq \frac{x}{2}$, then

$$\begin{aligned} q_1^{[1]}(t) &= \int_0^t q_1^{[0]}(s) ds = \int_0^t q_1(s) ds = \int_0^t q_0(2s) ds \\ &= \frac{1}{2} \int_0^{2t} q_1(u) du = \frac{1}{2} q_1^{[1]}(2t); \end{aligned}$$

and if $\frac{x}{2} \leq t \leq x$, then

$$\begin{aligned} q_1^{[1]}(t) &= \int_0^{\frac{x}{2}} q_1(s) ds + \int_{\frac{x}{2}}^t q_1(s) ds = q_1^{[1]}\left(\frac{x}{2}\right) - \int_{\frac{x}{2}}^t q_0(2s-x) ds \\ &= q_1^{[1]}\left(\frac{x}{2}\right) - \frac{1}{2} \int_0^{2t-x} q_0(u) du = q_1^{[1]}\left(\frac{x}{2}\right) - q_0^{[1]}(2t-x). \end{aligned}$$

It remains to prove that $q_1^{[1]}(\frac{x}{2}) = 0$. We have

$$\begin{aligned} q_1^{[1]}(\frac{x}{2}) &= \int_0^{\frac{x}{2}} q_1(s) ds = \int_0^{\frac{x}{2}} q_0(2s) ds = \frac{1}{2} \int_0^x q_0(u) du \\ &= \frac{1}{2} \left(\int_0^{\frac{x}{2}} q_0(2u) du - \int_{\frac{x}{2}}^x q_0(2u-x) du \right) \\ &= \frac{1}{2} \left(\int_0^x q_0(v) dv - \int_0^x q_0(v) dv \right) = 0. \end{aligned}$$

Therefore

$$q_1^{[1]}(t) = \begin{cases} \frac{1}{2} q_0^{[1]}(2t), & 0 \leq t \leq \frac{x}{2} \\ -\frac{1}{2} q_0^{[1]}(2t-x), & \frac{x}{2} \leq t \leq x. \end{cases}$$

Now by induction assume that, for any $0 \leq \ell \leq i \leq r-1$,

$$q_r^{[\ell]}(t) = \begin{cases} \frac{1}{2^\ell} q_{r-1}^{[\ell]}(2t), & 0 \leq t \leq \frac{x}{2} \\ -\frac{1}{2^\ell} q_{r-1}^{[\ell]}(2t-x), & \frac{x}{2} \leq t \leq x. \end{cases}$$

We have: if $0 \leq t \leq \frac{x}{2}$, then

$$\begin{aligned} q_r^{[i+1]}(t) &= \int_0^t q_r^{[i]}(s) ds = \frac{1}{2^i} \int_0^t q_{r-1}^{[i]}(2s) ds \\ &= \frac{1}{2^{i+1}} \int_0^{2t} q_{r-1}^{[i]}(u) du = \frac{1}{2^{i+1}} q_{r-1}^{[i+1]}(2t); \end{aligned}$$

and if $\frac{x}{2} \leq t \leq x$, then

$$\begin{aligned}
 q_r^{[i+1]}(t) &= \int_0^{\frac{x}{2}} q_r^{[i]}(s) ds + \int_{\frac{x}{2}}^t q_r^{[i]}(s) ds \\
 &= q_r^{[i+1]}\left(\frac{x}{2}\right) - \frac{1}{2^i} \int_{\frac{x}{2}}^t q_{r-1}^{[i]}(2s-x) ds \\
 &= q_r^{[i+1]}\left(\frac{x}{2}\right) - \frac{1}{2^{i+1}} \int_0^{2t-x} q_{r-1}^{[i]}(s) ds \\
 &= q_r^{[i+1]}\left(\frac{x}{2}\right) - \frac{1}{2^{i+1}} q_{r-1}^{[i+1]}(2t-x).
 \end{aligned}$$

It remains to prove $q_r^{[i+1]}(\frac{x}{2}) = 0$. We have that

$$\begin{aligned}
 q_r^{[i+1]}(\frac{x}{2}) &= \int_0^{\frac{x}{2}} q_r^{[i]}(s) ds = \frac{1}{2^i} \int_0^{\frac{x}{2}} q_{r-1}^{[i]}(2s) ds = \frac{1}{2^{i+1}} \int_0^x q_{r-1}^{[i]}(s) ds \\
 &= \frac{1}{2^{i+1}} \left(\int_0^{\frac{x}{2}} q_{r-2}^{[i]}(2s) ds - \int_{\frac{x}{2}}^x q_{r-2}^{[i]}(2s-x) ds \right) \\
 &= \frac{1}{2^{i+2}} \left(\int_0^x q_{r-2}^{[i]}(u) du - \int_0^x q_{r-2}^{[i]}(u) du \right) = 0.
 \end{aligned}$$

(2) Again, by induction on r we have three cases to consider:

(i) if $j = r$, then

$$\begin{aligned}
 q_r^{[i]}(x) &= \int_0^x q_r^{[i-1]}(s) ds = \int_0^{\frac{x}{2}} q_r^{[i-1]}(s) ds + \int_{\frac{x}{2}}^x q_r^{[i-1]}(s) ds \\
 &= \frac{1}{2^{i-1}} \int_0^{\frac{x}{2}} q_{r-1}^{[i-1]}(2s) ds - \frac{1}{2^{i-1}} \int_{\frac{x}{2}}^x q_{r-1}^{[i-1]}(2s-x) ds \\
 &= \frac{1}{2^i} \left(\int_0^x q_{r-1}^{[i-1]}(u) du - \int_0^x q_{r-1}^{[i-1]}(u) du \right) = 0;
 \end{aligned}$$

(ii) if $j = r - 1$, we have

$$\begin{aligned}
 q_r^{[i]}(\frac{x}{2}) &= \int_0^{\frac{x}{2}} q_r^{[i-1]}(s) ds = \int_0^{\frac{x}{2}} q_{r-1}^{[i-1]}(2s) ds = \frac{1}{2} \int_0^x q_{r-1}^{[i-1]}(u) du \\
 &= \frac{1}{2} \left(\int_0^{\frac{x}{2}} q_{r-2}^{[i-1]}(2u) du - \int_{\frac{x}{2}}^x q_{r-2}^{[i-1]}(2u-x) du \right) \\
 &= \frac{1}{2^2} \left(\int_0^x q_{r-2}^{[i-1]}(w) dw - \int_0^x q_{r-2}^{[i-1]}(w) dw \right) = 0;
 \end{aligned}$$

(iii) if $1 \leq i \leq j = r - \ell$, then $2^{j-r}x = \frac{x}{2^\ell}$ and

$$\begin{aligned}
q_r^{[i]} \left(\frac{x}{2^\ell} \right) &= \int_0^{\frac{x}{2^\ell}} q_r^{[i-1]}(s) ds \\
&= \int_0^{\frac{x}{2^\ell}} q_{r-1}^{[i-1]}(2s) ds = \frac{1}{2} \int_0^{\frac{x}{2^{\ell-1}}} q_{r-1}^{[i-1]}(s) ds \\
&= \frac{1}{2} \int_0^{\frac{x}{2^{\ell-1}}} q_{r-2}^{[i-1]}(2s) ds = \frac{1}{2^2} \int_0^{\frac{x}{2^{\ell-2}}} q_{r-2}^{[i-1]}(s) ds \\
&\vdots \\
&(\ell - 1) - \text{steps} \\
&\vdots \\
&= \frac{1}{2^{\ell-1}} \int_0^{\frac{x}{2}} q_{r-(\ell-1)}^{[i-1]}(s) ds \\
&= \frac{1}{2^{\ell-1}} \int_0^{\frac{x}{2}} q_{r-\ell}^{[i-1]}(2s) ds = \frac{1}{2^\ell} \int_0^x q_{r-\ell}^{[i-1]}(s) ds \\
&= \frac{1}{2^\ell} \left(\int_0^{\frac{x}{2}} q_{r-\ell}^{[i-1]}(s) ds + \int_{\frac{x}{2}}^x q_{r-\ell}^{[i-1]}(s) ds \right) \\
&= \frac{1}{2^\ell} \left(\int_0^{\frac{x}{2}} q_{r-\ell-1}^{[i-1]}(2s) ds - \int_{\frac{x}{2}}^x q_{r-\ell-1}^{[i-1]}(2s-x) ds \right) \\
&= \frac{1}{2^{\ell+1}} \left(\int_0^x q_{r-\ell-1}^{[i-1]}(s) ds - \int_0^x q_{r-\ell-1}^{[i-1]}(s) ds \right) = 0
\end{aligned}$$

which completes the proof of the lemma. \square

Now in order to see that $q_r^{[r+1-i]}(x) = 0$, we set $j = r$ in $q_r^{[\ell]}(2^{j-r}x) = 0$ and obtain that $q_r^{[\ell]}(x) = 0$. Next set $\ell = r+1-i$ and the claim $q_r^{[r+1-i]}(x) = 0$ follows.

We next return to the proof of the Main Lemma.

As for statement (3), we estimate the maximum value of $|h^{(i)}(t)|$. For any $1 \leq i \leq r$, we have

$$\left| h^{(i)}(t) \right| = \frac{|y - ax|}{|q_r^{[r+1]}(x)|} \left| q_r^{[r+1-i]}(t) \right|.$$

We now have the following

Lemma 8 *For any $\delta > 0$, if we take V large enough (namely, if $[0, x] - V$ is very small), then $|q_r^{[i]}(t) - k_r^{[i]}(t)| \leq \delta$, for any $1 \leq i \leq r$ and $t \in [0, x]$.*

Proof. Let $A = \{t \in [0, x] : q_r(t) \neq k_r(t)\}$. It is clear that if we take V large enough, then $m(A) = m([0, x] - V)$ is very small (m denotes the Lebesgue measure).

For the statement we make induction on i .

(a) For $i = 1$,

$$\begin{aligned} |q_r^{[1]}(t) - k_r^{[1]}(t)| &= \left| \int_0^t q_r(s) - k_r(s) ds \right| \leq \int_0^t |q_r(s) - k_r(s)| ds \\ &\leq \int_0^x |q_r(s) - k_r(s)| ds = \int_A |q_r(s) - k_r(s)| ds \\ &< \int_A ds = m(A) = m([0, x] - V). \end{aligned}$$

(b) By induction assume that $|q_r^{[i]}(t) - k_r^{[i]}(t)| < m([0, x] - V)$, for any $1 \leq i \leq r - 1$. Then we have

$$\begin{aligned} |q_r^{[i+1]}(t) - k_r^{[i+1]}(t)| &= \left| \int_0^t q_r^{[i]}(s) - k_r^{[i]}(s) ds \right| \\ &\leq \int_0^t |q_r^{[i]}(s) - k_r^{[i]}(s)| ds \\ &\leq \int_0^t m([0, x] - V) ds = t m([0, x] - V) \\ &\leq x m([0, x] - V) < m([0, x] - V). \end{aligned}$$

Now to complete the proof of statement (3) of the Main Lemma, we note that by assumption

$$|y - ax| < x^{r+1} \cdot 2^{-\frac{r(r+1)}{2}}.$$

Therefore, there exists a constant $0 < C < 1$ such that

$$|y - ax| < C x^{r+1} \cdot 2^{-\frac{r(r+1)}{2}}.$$

If q_r is sufficiently close to k_r , we have

$$|q_r^{[r+1]}(x)| \geq C |k_r^{[r+1]}(x)|,$$

and by Lemma 6, for any $1 \leq i \leq r$ and $0 \leq t \leq x$,

$$|k_r^{[r+1-i]}(t)| \leq 2^{\frac{(r-i)(r-i-1)}{2} - r(r+1-i)} \cdot x^{r+1-i}.$$

Now let δ be a positive number satisfying $\delta < \frac{\varepsilon - x}{2^r}$. By Lemma 8, and if we take V large enough, q_r satisfies $|q_r^{[i]}(t) - k_r^{[i]}(t)| \leq \delta$, for any $1 \leq i \leq r$ and

$t \in [0, x]$. Thus we have

$$\begin{aligned}
|h^{(i)}(t)| &= \frac{|y - ax|}{|q_r^{[r+1]}(x)|} |q_r^{[r+1-i]}(t)| \\
&\leq \frac{|y - ax|}{C |k_r^{[r+1]}(x)|} (|k_r^{[r+1-i]}(t)| + \delta) \\
&\leq |y - ax| \cdot C^{-1} \cdot x^{-i} \cdot 2^{\frac{i(i+1)}{2}} \\
&\quad + |y - ax| \cdot C^{-1} \cdot x^{-(r+1)} \cdot 2^{\frac{r(r+3)}{2}} \cdot \delta \\
&< x^{r+1-i} + 2^r \cdot \delta \leq x + 2^r \cdot \delta < \varepsilon.
\end{aligned}$$

□

5. Proof of Theorem 1

Let $s = (\lambda_n)_{n \in \mathbb{N}}$ be a sequence of real numbers as in the hypotheses of Theorem 1.

Assume that we have defined maps of class C^r , $g_k : I^1 \rightarrow [0, 1]$, $k = 1, \dots, n$, which are strictly monotone on each connected component of I^1 , and such that their graphics contain two vertices of each rectangle R_γ^n , $\gamma \in \Delta_n$. To define g_{n+1} we change the definition of g_n on each interval $\pi_1(R_\gamma^n) = \pi_1(R_{\gamma_1}^{n+1}) \cup \pi_1(L_\gamma) \cup \pi_1(R_{\gamma_2}^{n+1})$, $\gamma \in \Delta_n$. For this we apply the Main Lemma in each rectangle $R_{\gamma_1}^{n+1}$, L_γ and $R_{\gamma_2}^{n+1}$, $\gamma \in \Delta_n$, hence obtaining a C^r map $g_{n+1} : I^1 \rightarrow [0, 1]$ which is strictly monotone on each connected component of I^1 and such that its graphic contains two vertices of each of the rectangles R_γ^{n+1} and of the rectangles L_γ , $\gamma \in \Delta_{n+1}$, thus ending the induction step.

Since $m(I^n) \rightarrow 0$, as $n \rightarrow \infty$ (m the Lebesgue measure), from the Main Lemma it follows that given $\varepsilon > 0$, there is $N \in \mathbb{N}$ such that $g'_n|_{I^N}$ is ε -close to the constant map $\lambda(t) = \frac{1}{\lambda}$, $n \geq N$, and that $g_n^{(i)}|_{I^N}$ is ε -close to the null map, $i = 1, \dots, r$. We conclude that, for $i = 1, \dots, r$, the sequences $(g_n^{(i)})_{n \in \mathbb{N}}$ converge uniformly and, therefore, $f = \lim_{n \rightarrow \infty} g_n$ is a map of class C^r , which ends the proof of Theorem 1 in this case.

For the general case, the arguments are analogous with the corresponding modifications.

Remark 6. Clearly, if $\lambda \in]0, \frac{1}{2}[$, the constant sequence $\lambda_n = \lambda$, $n \in \mathbb{N}$, satisfies the conditions of Theorem 1.

6. Proof of Corollary 2

It suffices to show that the sequence $(\lambda_n)_{n \in \mathbb{N}}$ satisfies the conditions of Theorem 1.

1. We have that

$$\left| \frac{1}{\lambda_n} - \frac{1}{\lambda} \right| < 2^{-\frac{r(r+1)}{2}} \lambda_1^{(n+t)r} < 2^{-\frac{r(r+1)}{2}} (\prod_{i=1}^n \lambda_i)^r,$$

and thus condition 1 of Theorem 1 holds.

2. Since $\left| \frac{1}{\lambda_n} - \frac{1}{\lambda} \right| < 2^{-\frac{r(r+1)}{2}} \lambda_1^{(n+t)r}$, it follows that $|\lambda - \lambda_n| < \lambda_n \lambda_1^{(n+t)r} 2^{-\frac{r(r+1)}{2}}$.

Now we have

$$\begin{aligned} \left| \frac{1}{\lambda_n} \frac{1 - (p+1)\lambda_n}{1 - (p+1)\lambda_{n+1}} - \frac{1}{\lambda} \right| &= \frac{p+1}{\lambda_n} \frac{|\lambda_{n+1} - \lambda_n|}{|1 - (p+1)\lambda_{n+1}|} \\ &< \frac{1}{\lambda_n} \frac{p+1}{1 - (p+1)\lambda} 2^{-\frac{r(r+1)}{2}} \lambda_n \lambda_1^{(n+t)r}; \end{aligned}$$

that is,

$$\left| \frac{1}{\lambda_n} \frac{1 - (p+1)\lambda_n}{1 - (p+1)\lambda_{n+1}} - \frac{1}{\lambda} \right| < \frac{p+1}{1 - (p+1)\lambda} 2^{-\frac{r(r+1)}{2}} \lambda_1^{(n+t)r}.$$

Finally

$$\begin{aligned} &\left| \frac{1}{\lambda_n} \frac{1 - (p+1)\lambda_n}{1 - (p+1)\lambda_{n+1}} - \frac{1}{\lambda} \right| \\ &\leq \left| \frac{1}{\lambda_n} \frac{1 - (p+1)\lambda_n}{1 - (p+1)\lambda_{n+1}} - \frac{1}{\lambda_n} \right| + \left| \frac{1}{\lambda_n} - \frac{1}{\lambda} \right| \\ &< \frac{p+1}{1 - (p+1)\lambda} 2^{-\frac{r(r+1)}{2}} \lambda_1^{(n+t)r} + 2^{-\frac{r(r+1)}{2}} \lambda_1^{(n+t)r} \\ &= 2^{-\frac{r(r+1)}{2}} \lambda_1^{nr} \lambda_1^{tr} \left(\frac{p+1}{1 - (p+1)\lambda} + 1 \right) \\ &< 2^{-\frac{r(r+1)}{2}} \cdot (\prod_{i=1}^n \lambda_i)^r \cdot \left(\frac{1 - (p+1)\lambda}{p} \right)^r \\ &< 2^{-\frac{r(r+1)}{2}} \cdot (\prod_{i=1}^n \lambda_i)^r \cdot \left(\frac{1 - (p+1)\lambda_{n+1}}{p} \right)^r; \end{aligned}$$

that is, condition 2 of Theorem 1 holds.

7. Proof of Theorem 2

The sequence $s = (\lambda_n)_{n \in \mathbb{N}}$ satisfies the conditions of Theorem 1 and, hence, the associated p -central Cantor set $\Lambda(p, s)$ is of class C^r , $r \geq 1$. Let $\Lambda = \bigcap_{n=1}^{\infty} I^n$ be as in Definition 2. From hypothesis (1) it is easily seen that the arithmetic difference $J^n = I^n - I^n$ is the union of $(2p+1)^n$ disjoint intervals of length $2 \prod_{i=1}^n \lambda_i$. Then $K = \bigcap_{n=1}^{\infty} J^n$ is a Cantor set with Lebesgue measure $m(K) = \lim_{n \rightarrow \infty} m(J^n) = \lim_{n \rightarrow \infty} 2 \prod_{i=1}^n ((2p+1)\lambda_i)$. From hypothesis (2) we see that $m(K) > 0$. Finally, it is easy to see that $K = \Lambda - \Lambda$ (see [S]). In particular, $\lim_{i \rightarrow \infty} \lambda_i = \frac{1}{2p+1}$.

8. Hausdorff dimension and limit capacity of central Cantor sets

We now recall the definitions of Hausdorff dimension and limit capacity of sets; we next apply these concepts to central Cantor sets in order to prove that the above examples are “frontier examples”, which will become clear in the end.

In order to define the Hausdorff dimension and the limit capacity, we consider a metric space (X, d) .

8.1. Hausdorff dimension

The diameter of a subset U of X , which we denote by $|U|$, is $\sup\{d(x, y) : x, y \in U\}$. Let $E \subset X$, and let $\delta > 0$. We will say a collection $\{U_i\}_{i \in \Gamma}$ is a δ -cover of E if $E \subset \bigcup_{i \in \Gamma} U_i$ and $0 < |U_i| < \delta$.

Let $s > 0$. The s -dimensional Hausdorff measure of E is

$$\mathcal{H}^s(E) = \liminf_{\delta \rightarrow 0} \left\{ \sum_{i=1}^{\infty} |U_i|^s : \{U_i\}_{i \in \mathbb{N}} \text{ is a countable } \delta\text{-cover of } E \right\}.$$

Set $\mathcal{H}_\delta^s(E) = \inf\{\sum_{i=1}^{\infty} |U_i|^s : \{U_i\}_{i \in \mathbb{N}} \text{ is a countable } \delta\text{-cover of } E\}$. It is clear that $\delta < \delta'$ implies $\mathcal{H}_\delta^s(E) \geq \mathcal{H}_{\delta'}^s(E)$. Thus, fixing $E \subset X$ and $s > 0$, the function $\delta \rightarrow \mathcal{H}_\delta^s(E)$ is non-increasing and, therefore, there always exists $\lim_{\delta \rightarrow 0} \mathcal{H}_\delta^s(E) = \sup_{\delta > 0} \mathcal{H}_\delta^s(E)$. Hence $\mathcal{H}^s(E)$ is well defined, for any subset $E \subset X$. Moreover, the set function $E \rightarrow \mathcal{H}^s(E)$ is an outer measure on X as well as a measure on the class of Borel subsets of X . Let $E \subset X$. It is well known that there is a unique value s_0 such that

$$\mathcal{H}^s(E) = \begin{cases} \infty & \text{if } s < s_0 \\ 0 & \text{if } s > s_0. \end{cases}$$

Note that $\mathcal{H}^{s_0}(E)$ may be 0, $+\infty$ or a finite nonzero value. The value s_0 , where $\mathcal{H}^s(E)$ jumps from ∞ to 0, is called the *Hausdorff dimension* of E and is denoted $HD(E)$. For a more detailed discussion of the Hausdorff dimension and its properties, see [PT] and [F].

8.2. Limit Capacity

Let $E \subset X$ be a compact set. For $\varepsilon > 0$, set $n(\varepsilon)$ as the smallest number of ε -balls (i.e., balls of radius ε) needed to cover E . The limit capacity of E is

$$d(E) = \limsup_{\varepsilon \rightarrow 0} \frac{\ln(n(\varepsilon))}{-\ln(\varepsilon)}.$$

It is easy to see that $HD(E) \leq d(E)$, for any compact subset E of X (cf. [PT]).

Now we have the following

Proposition 1 *Let $\Lambda(p, s)$ be a p -central Cantor set defined by a sequence $s = (\lambda_n)_{n \in \mathbb{N}}$, with $\lim_{n \rightarrow \infty} \lambda_n = \lambda \neq 0$. Then $d(\Lambda(p, s)) = \frac{\log(p+1)}{\log(\lambda^{-1})}$.*

Proof. Note that in the n -th step of the construction of $\Lambda(p, s)$ the set I^n is the union of $(p+1)^n$ intervals each of length $\prod_{i=1}^n \lambda_i$. Therefore

$$\begin{aligned} d(\Lambda(p, s)) &= \lim_{n \rightarrow \infty} \frac{\log((p+1)^n)}{-\log(\prod_{i=1}^n \lambda_i)} = \lim_{n \rightarrow \infty} \frac{-\log(p+1)}{\frac{1}{n} \log(\prod_{i=1}^n \lambda_i)} \\ &= \lim_{n \rightarrow \infty} \frac{-\log(p+1)}{\frac{1}{n} \sum_{i=1}^n \log(\lambda_i)} = \frac{\log(p+1)}{\log(\lambda^{-1})}. \end{aligned}$$

□

Also note that $d(\Lambda(p, s))$ is equal to the limit capacity of the p - λ -central Cantor set. Hence it follows that $HD(\Lambda(p)) \leq \frac{\log(p+1)}{\log(\lambda^{-1})}$. If $\Lambda(p, s)$ is regular of class C^r , $r \geq 2$, it is dynamically defined. For this class of Cantor sets, we have that its Hausdorff dimension and limit capacity are equal (cf. [PT, p. 80, Proposition 7]); hence $HD(\Lambda(p, s)) = \frac{\log(p+1)}{\log(\lambda^{-1})}$.

For the case $r = 1$ and in order to obtain lower bounds for $HD(\Lambda(p, s))$, we use the following *mass distribution principle* (see [F]). We first recall that a mass distribution on a set F is a measure μ with support contained in F and such that $0 < \mu(F) < \infty$. In fact, we may always suppose that $\mu(F) = 1$, i.e., μ is mass distribution probability.

Theorem 3 (cf. [B] or [F]) *Let μ be a mass distribution on a set F . For some $s > 0$, suppose there are numbers $c > 0$ and $\delta > 0$ such that $\mu(U) \leq c|U|^s$, for any set U with $|U| < \delta$. Then $\mathcal{H}^s(F) \geq \frac{\mu(F)}{c}$ and, consequently, $s \leq HD(F)$.*

We now apply this mass distribution principle to obtain a lower bound for the Hausdorff dimension of a p -central Cantor set $\Lambda(p, s)$, with $s = (\lambda_n)_{n \in \mathbb{N}}$ as above.

Recall that $\Lambda(p, s) = \bigcap_{n \geq 0} I^n$ where $I^n = \bigcup_{j=1}^{(p+1)^n} I_j^n$ and the I_j^n are closed intervals each of length $\prod_{i=1}^n \lambda_i$, with $I_j^n \cap I_\ell^n = \emptyset$, $j \neq \ell$. We define a mass distribution μ on $\Lambda(p, s)$ as $\mu = \lim_{n \rightarrow \infty} \mu_n$, where μ_n is a mass distribution on I^n defined as follows: each interval I_j^n of I^n carries a mass equaling $(\frac{1}{p+1})^n$.

Now let $U \subset I$ be an interval of length $|U| \leq 1$, and let n be the integer such that $\prod_{i=1}^{n+1} \lambda_i \leq |U| < \prod_{i=1}^n \lambda_i$. Hence U can intersect at most one of the $(p+1)^n$ intervals I_j^n of I^n . Set $t = \frac{\log(p+1)}{\log(\lambda^{-1})} = d(\Lambda(p, s))$. Then

$$\begin{aligned} \mu_n(U) &\leq (p+1)^{-n} = (e^{\log(\prod_{i=1}^n \lambda_i)})^{-\frac{n \log(p+1)}{\log(\prod_{i=1}^n \lambda_i)}} \\ &= (\prod_{i=1}^n \lambda_i)^{-\frac{n \log(p+1)}{\log(\prod_{i=1}^n \lambda_i)}}. \end{aligned}$$

Now since $\prod_{i=1}^{n+1} \lambda_i \leq |U|$, it follows that $\prod_{i=1}^n \lambda_i \leq \lambda_{n+1}^{-1} |U|$ and that

$$\mu_n(U) \leq |U|^{-\frac{n \log(p+1)}{\log(\prod_{i=1}^n \lambda_i)}} \lambda_{n+1}^{\frac{n \log(p+1)}{\log(\prod_{i=1}^n \lambda_i)}}.$$

Set $s_n = -\frac{n \log(p+1)}{\log(\prod_{i=1}^n \lambda_i)}$, and set $c_n = \lambda_{n+1}^{\frac{\frac{1}{n} \log(p+1)}{\frac{1}{n} \log(\prod_{i=1}^n \lambda_i)}}$. Therefore the inequality above may be rewritten as $\mu_n(U) \leq c_n |U|^{s_n}$. On the other hand, $\lim_{n \rightarrow \infty} c_n = \lambda^{\frac{\log(p+1)}{\log(\lambda)}} = p+1$ and $\lim_{n \rightarrow \infty} s_n = \frac{\log(p+1)}{\log(\lambda^{-1})} = t$. Hence $\mathcal{H}^t(\Lambda(p, s)) > 0$ and $HD(\Lambda(p, s)) \geq t = d(\Lambda(p, s))$. Therefore $HD(\Lambda(p, s)) = d(\Lambda(p, s)) = \frac{\log(p+1)}{\log(\lambda^{-1})}$.

Remark 7. If $A \subset \mathbb{R}$, then $HD(A) < 1$ implies $m(A) = 0$.

When a Cantor set $\Lambda \subset \mathbb{R}$ is dynamically defined we have that $0 < HD(\Lambda) = d(\Lambda) < 1$, hence $m(\Lambda) = 0$ (cf. [PT, p. 80, Proposition 7]). In general, the situation (although it is not our case) is rather different for Cantor sets which are only C^1 . In [Bo] R. Bowen has constructed an example

of a C^1 Cantor set of positive Lebesgue measure.

We next prove the following

Proposition 2 *Let $\Lambda(p, s) \subset [0, 1]$ be a p -central Cantor set constructed from a sequence $s = (\lambda_i)_{i \in \mathbb{N}}$, $0 < \lambda_i < \frac{1}{p+1}$. Assume that $\lim_{i \rightarrow \infty} \lambda_i = \lambda$ and that $\lambda \neq 0$. Then we have the following two possibilities:*

- a) *if $\lambda > \frac{1}{2p+1}$, then $\Lambda(p, s) - \Lambda(p, s)$ contains intervals;*
- b) *if $\lambda < \frac{1}{2p+1}$, then $\Lambda(p, s) - \Lambda(p, s)$ is a Cantor set of zero Lebesgue measure.*

Proof. Geometrically the difference of $x, y \in \mathbb{R}$, $x - y$, is obtained projecting the point $(x, y) \in \mathbb{R}^2$ on the x -axis through the direction $\theta = \pi/4$. We let proj_θ denote this projection. Now $\Lambda(p, s) = \bigcap_{n \geq 0} I^n$, where $I^n = \bigcup_{i=1}^{(p+1)^n} I_i^n$ is the union of $(p+1)^n$ intervals each of length $\prod_{i=1}^n \lambda_i$; hence $I^n \times I^n = \bigcup_{i,j=1}^{(p+1)^n} I_i^n \times I_j^n$. On the other hand, we know that $\Lambda(p, s) - \Lambda(p, s) = \bigcap_{n \geq 0} J^n$, where J^n is the union of $(2p+1)^n$ intervals each of length $2 \prod_{i=1}^n \lambda_i$. In fact, $J^n = I^n - I^n = \bigcup_{i,j \geq 1} (I_i^n - I_j^n)$.

We first study the case $\lambda_n = \frac{1}{2p+1}$, for any $n \geq 1$. It is clear that the projection $\text{proj}_\theta(I_i^n \times I_j^n)$, $i, j = 1, \dots, (p+1)^n$, covers all of $[-1, 1]$. These projections intersect at points of the form $\frac{k}{2p+1}$ and, moreover, there are no overlaps.

Now assume that $\lambda = \lim_{n \rightarrow \infty} \lambda_n > \frac{1}{2p+1}$. Then there exists $n_0 \geq 1$ such that $\prod_{i=1}^{n_0} \lambda_i \geq (\frac{1}{2p+1})^{n_0}$ and, therefore, the projection $\text{proj}_\theta(I_i^{n_0} \times I_j^{n_0})$ is always an interval, for all $n \geq n_0$; thus $\Lambda(p, s) - \Lambda(p, s)$ contains intervals. Note that, for $n < n_0$, $J^n = I^n - I^n$ may contain gaps.

If $\lambda < \frac{1}{2p+1}$, there exists $n_0 \geq 1$ such that $\prod_{i=1}^{n_0} \lambda_i < (\frac{1}{2p+1})^{n_0}$, for all $n \geq n_0$, and it is easy to see that $\Lambda(p, s) - \Lambda(p, s)$ is a Cantor set of zero Lebesgue measure. Note that the projection set J^n may not contain gaps for $n < n_0$, but if we iterate our construction process of the difference set $J^n = I^n - I^n$ a large enough number of times, then such gaps must necessarily appear. \square

Remark 8. For the case $\lambda = \frac{1}{2p+1}$, we have that $\Lambda(p, s) - \Lambda(p, s)$ may be a Cantor set of positive Lebesgue measure. In fact, this possibility occurs when the sequence $s = (\lambda_n)_{n \in \mathbb{N}}$ satisfies the hypotheses of theorems 1 and 2. This proposition also shows that our examples are “frontier examples”, since a “small perturbation” of them yields regular Cantor sets whose self-

arithmetic difference set either contains intervals or is a Cantor set of zero Lebesgue measure.

Remark 9. In a certain sense the p -central Cantor sets $\Lambda(p, s)$, with $p \geq 1$ and $s = (\lambda_n)_{n \in \mathbb{N}}$ a sequence which satisfies conditions of theorems 1 and 2, for some $r \geq 1$ (i.e., they are regular Cantor sets of class C^r and their self-arithmetic difference set is a Cantor set of positive Lebesgue measure), are “so near” to the rigid p -central Cantor sets $\Lambda(p, \lambda)$, where $\lambda = \lim_{n \rightarrow \infty} \lambda_n = \frac{1}{2p+1}$, which satisfy $\Lambda(p, \lambda) - \Lambda(p, \lambda) = [-1, 1]$.

9. Example

We now give an example of a construction of a diffeomorphism f in the sphere S^2 , with a basic set Γ (a horseshoe) which is the product of a central Cantor set Λ with itself (cf. [Bo] for an analogous construction).

Let $s = (\lambda_n)_{n \in \mathbb{N}}$, with $\lambda_0 = 1$ and $0 < \lambda_n < \frac{1}{2}$, $n \geq 1$, be a sequence which defines a central Cantor set Λ . Assume that $(\lambda_n)_{n \in \mathbb{N}}$ satisfies the conditions of Theorem 1, for some $r \geq 1$. Then Λ is a C^r regular Cantor set. Let $\varphi : I_1 \cup I_2 \rightarrow I$ be the C^r function which defines Λ , that is, $\Lambda = \bigcap_{i=0}^{\infty} \varphi^{-i}(I)$.

We assume that φ is strictly increasing in I_1 , and that it is strictly decreasing in I_2 . We denote $\varphi_i = \varphi|_{I_i}$, $i = 1, 2$. Let $R_1 = [0, \lambda_1] \times I$, and $R_2 = [1 - \lambda_1, 1] \times I$. Define $f : R_1 \cup R_2 \rightarrow \mathbb{R}^2$ by

$$f(x, y) = \begin{cases} (\varphi_1(x), \varphi_1^{-1}(y)), & \text{if } (x, y) \in R_1 \\ (\varphi_2(x), \varphi_2^{-1}(y)), & \text{if } (x, y) \in R_2. \end{cases}$$

It is easy to see that $f(R_1) = I \times [0, \lambda_1]$, and that $f(R_2) = I \times [1 - \lambda_1, 1]$. The images of R_1 and R_2 under f are shown in Figure 6 (a).

Now we extend f to $I \times I$ applying the rectangle $[\lambda_1, 1 - \lambda_1] \times I$ into a horseshoe as is shown in Figure 6 (b).

Note that $p = (0, 0)$ is a hyperbolic fixed point of f , with eigenvalues equaling λ and λ^{-1} . The local unstable manifold of p contains $I \times \{0\}$, and its local stable manifold contains $\{0\} \times I$. Finally, we extend f to S^2 as in the classical horseshoe example (cf. [PM]).

Now, as is done in [N], we may perturb f outside $\Lambda(p, s)$ in such a way as to create a homoclinic tangency. When we unfold this homoclinic tangency we see that $\Lambda - \Lambda$ is the set where there are primary homoclinic tangencies. Thus if we choose the sequence $(\lambda_n)_{n \in \mathbb{N}}$ as in Theorem 2, we

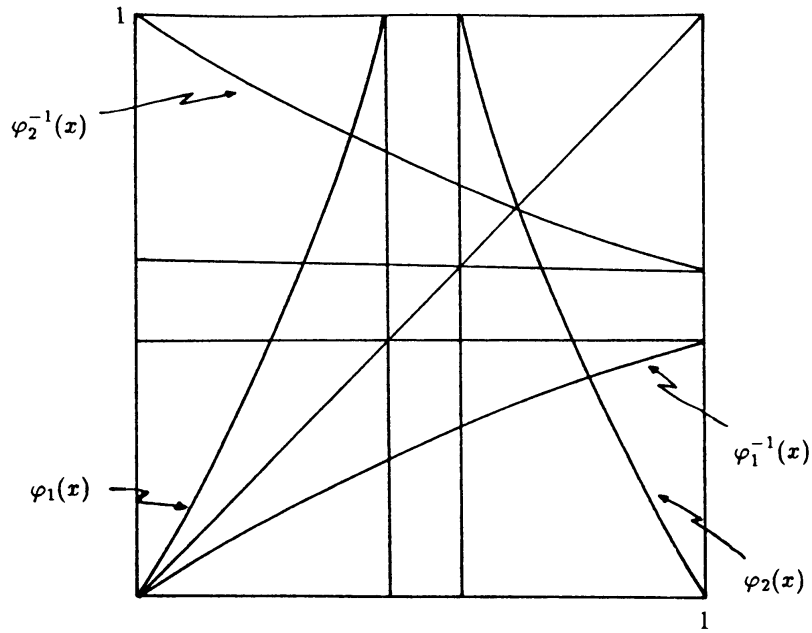

Fig. 6. (a)

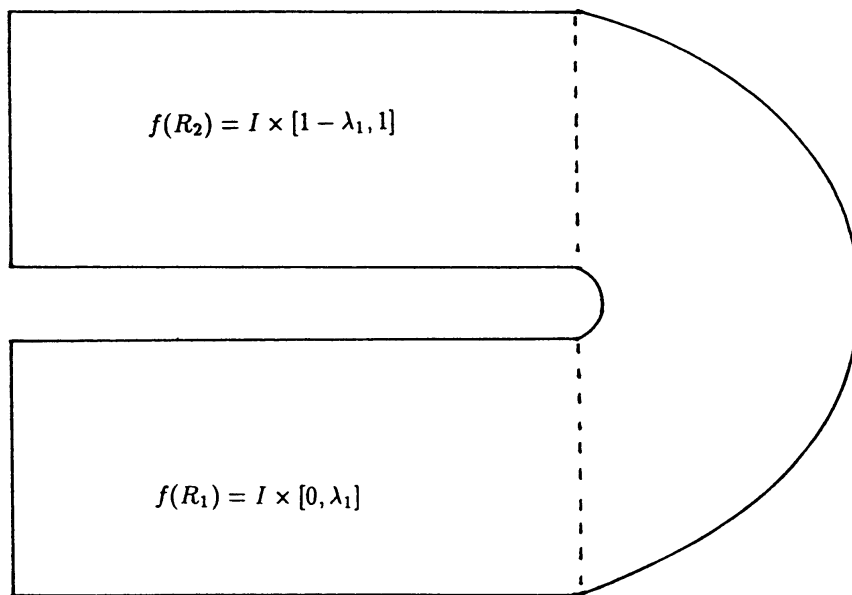

Fig. 6. (b)

have that the set $\Lambda - \Lambda = \{\mu : \Lambda \cap (\Lambda + \mu) \neq \emptyset\}$ has positive Lebesgue measure. Other possibilities for a construction of a horseshoe are shown in figures 7, and 8.

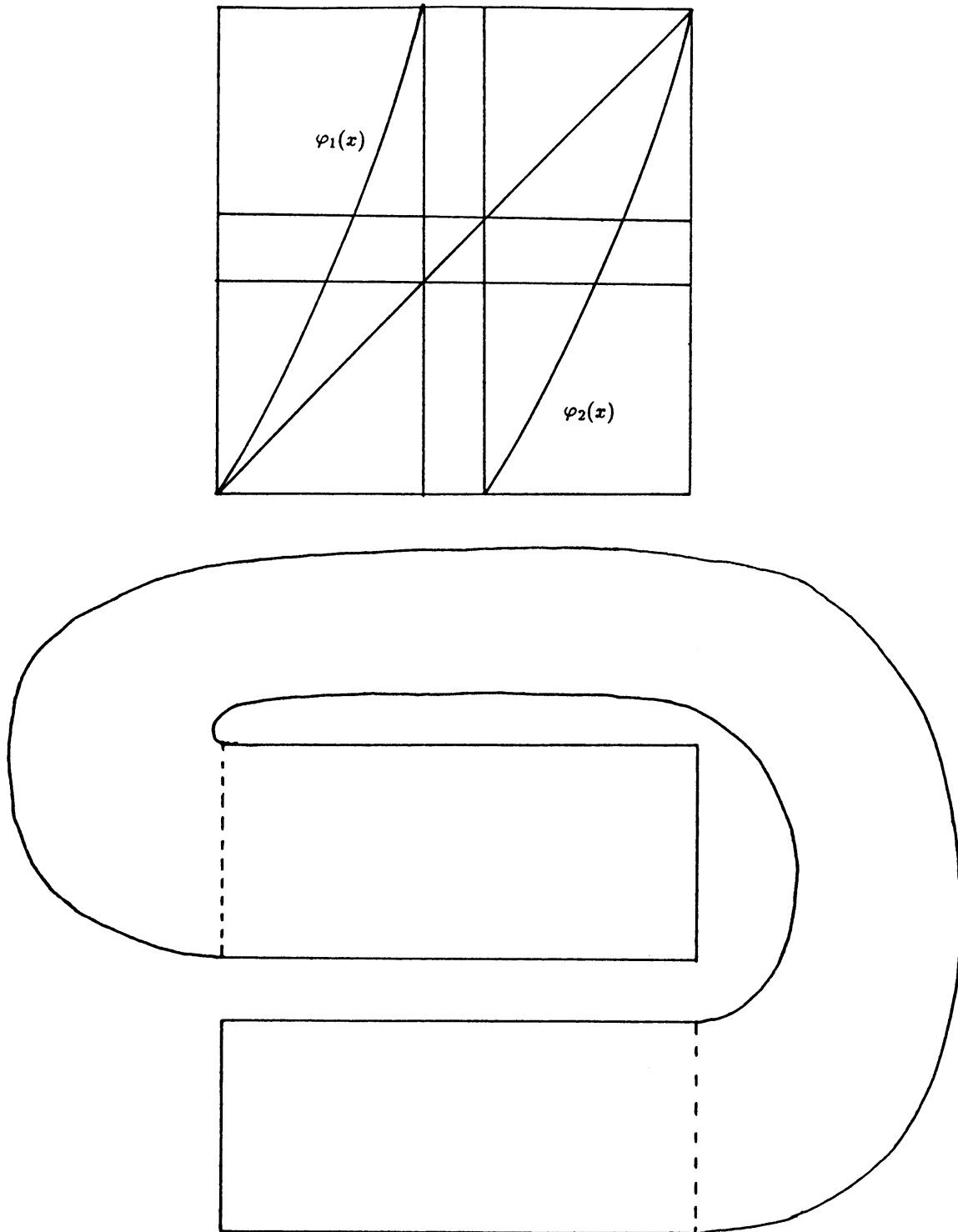

Fig. 7.

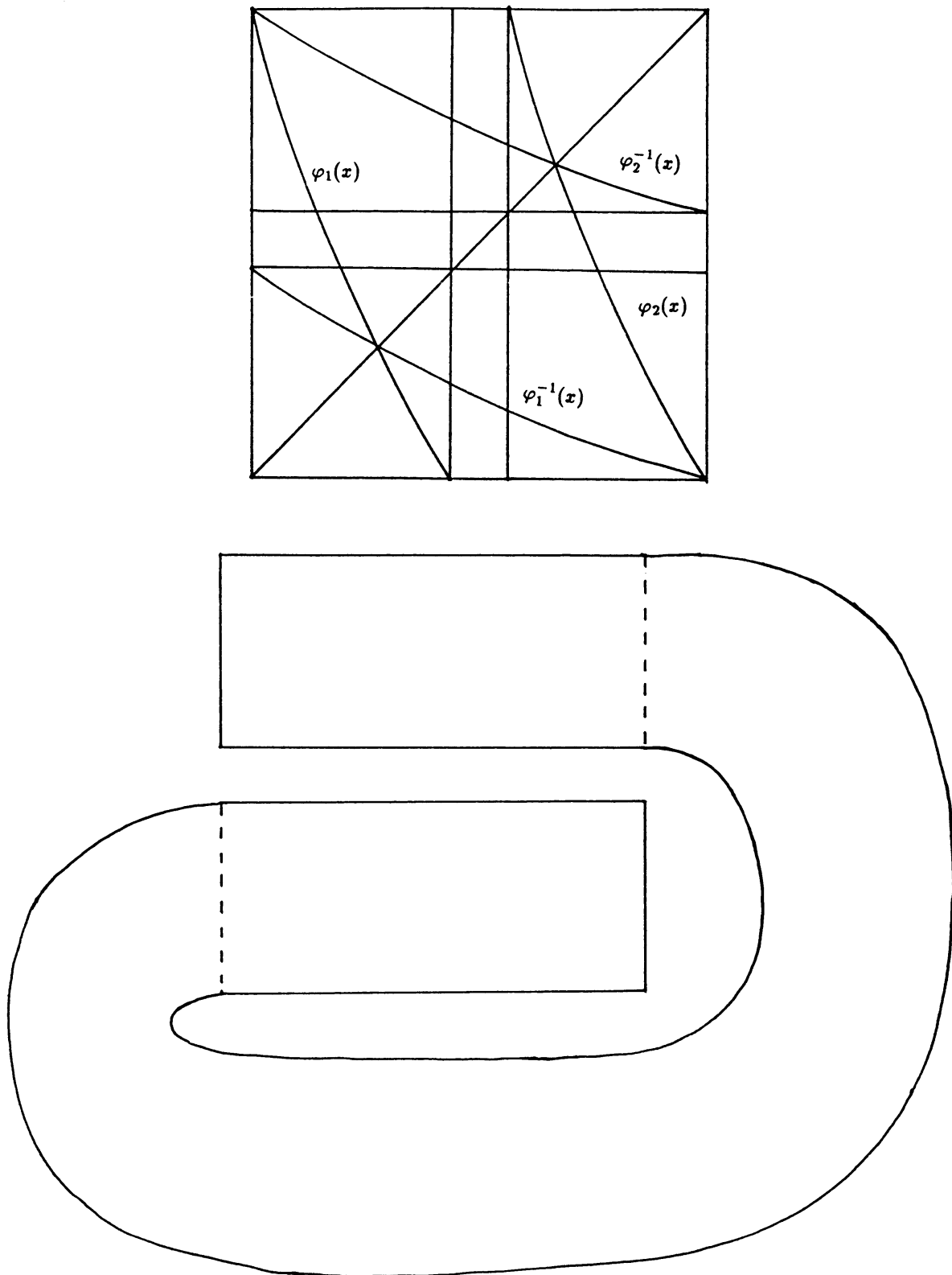

Fig. 8.

Acknowledgments This article is an outgrowth of research begun during one of the authors' visit to ICTP (Trieste - Italy) and IMPA-Brazil. We are grateful to these institutions for their support and stimulating working conditions. In addition we wish to thank R. Labarca for his helpful comments. We are also most grateful to the referee for his suggesting the decomposition of the proof of the Main Lemma into lemmas 2 through 8.

References

- [BPV] Bamón R., Plaza S. and Vera, J., *On Central Cantor with Self-Arithmetic Difference of Positive Lebesgue Measure*. Journal of London Math. Soc. (2) **52** (1995), 137–146.
- [B] Beardon A., *Iteration of rational Functions*. Spriger-Verlag, 1991.
- [Bo] Bowen R., *A Horseshoe with positive measure*. Inventiones Math. **29** (1975), 203–204.
- [PM] de Melo, W. and Palis J., *Introduction to Dynamical Systems*. Springer-Verlag, 1982.
- [Fa] Falconer K., *Fractal Geometry*. J. Wiley & Son 1990.
- [Fa1] Falconer K., *The Geometry of Fractal Sets*. Cambridge Univ. Press, 1985.
- [L] Larsson P., *L'ensemble différence de deux ensembles de Cantor aléatoires*. C. R. Sci. Paris, t.310, Série I (1990), 735–738.
- [H] Hall M., *On the sum and product of continued fractions*. Annals of Math. **48** (1947), 966–973.
- [MO] Mendes P. and Oliveira F., *On the topological structure of the arithmetic sum of two Cantor sets*. Nonlinearity **7** (1994), 329–343.
- [N] Newhouse S. *The abundance of wild hyperbolic sets and non-smooth stable sets for diffeomorphisms*. Publ. Math. I.H.E.S. **50** (1979), 101–151.
- [P] Palis J. *Homoclinic orbits, hyperbolic dynamics and dimension of Cantor sets*. Contemporary Mathematics vol. **58**, part III, (1987), 204–216.
- [PT] Palis J. and Takens F., *Hyperbolicity and sensitive chaotic dynamics at homoclinic bifurcations: fractal dimensions and infinitely many attractors*. Cambridge Univ. Press, 1993.
- [PT,1] Palis J. and Takens F., *Cycles and measure of bifurcation sets for two-dimensional diffeomorphisms*. Invent. Math. **82** (1985), 379–442.
- [PT,2] Palis J. and Takens F., *Hyperbolicity and the creation of homoclinic orbits*. Annals of Math. **125** (1987), 337–374.
- [S] Sannami A., *An example of a regular Cantor set whose difference set is a Cantor set with positive measure*. Hokkaido Math. Journal, Vol. **XXI** (1) (1992), 7–24.
- [W] Williams R.F., *How big is the intersection of two Cantor sets?*. Contemporary Mathematics, vol. **117**, (1991), 163–175.

Sergio Plaza

Depto. de Matemáticas, Facultad de Ciencias

Universidad de Santiago de Chile

Casilla 307, Correo 2. Santiago, Chile

E-mail: splaza@femat.usach.cl

Jaime Vera

Depto. de Matemáticas, Facultad de Ciencias,

Universidad Católica del Norte. Avda.

Angamos 0610, Antofagasta, Chile